

NOT MEASUREMENT
SENSITIVE

MIL-STD-810H
31 January 2019

SUPERSEDING
MIL-STD-810G
w/Change 1
15 April 2014

DEPARTMENT OF DEFENSE TEST METHOD STANDARD



ENVIRONMENTAL ENGINEERING CONSIDERATIONS AND LABORATORY TESTS

AMSC N/A

AREA ENVR

DISTRIBUTION STATEMENT A. Approved for public release; distribution is unlimited.

MIL-STD-810H
PART ONE

FOREWORD

1. This Standard is approved for use by all Departments and Agencies of the Department of Defense (DoD). Although prepared specifically for DoD applications, this Standard may be tailored for commercial applications as well. This Change Notice to version G incorporates updates and clarifications to the earlier edition. The primary emphases are still the same - (with the exception of Method 528) tailoring a materiel item's environmental design and test limits to the conditions that the specific materiel will experience throughout its service life, and establishing laboratory test methods that replicate the effects of environments on materiel, rather than trying to reproduce the environments themselves. The goal is to provide an up-front explanation of how to implement the environmental tailoring process throughout the materiel acquisition cycle.

This revision recognizes that the environmental design and test tailoring process has expanded to involve a wide range of managerial and technical interests. Accordingly, this revision orients environmental design and test direction toward three basic types of users who have distinctly different, although closely associated, interests: Program Managers who, among other responsibilities, ensure proposed concepts and systems are valid and functional in intended operational environments; environmental engineering specialists (EES), who enter the acquisition process early to assist combat and materiel developer tailoring efforts by preparing life cycle environmental profiles and drafting tailored design criteria and test programs; and the design, test, and evaluation community, whose analysts, engineers, and facility operators use tailored designs and tests to meet user needs.

2. **Part One** describes management, engineering, and technical roles in the environmental design and test tailoring process. It focuses on the process of tailoring materiel design and test criteria to the specific environmental conditions a materiel item is likely to encounter during its service life. Annex A contains complete descriptions of environmental engineering tasks, including additional guidance on Task 402, Life Cycle Environmental Profile (LCEP). These tasks, along with management information in Annex B and EES guidance in Annex C, will help to ensure the environmental design and test tailoring process is implemented and documented according to the disciplined, but flexible approach to materiel acquisition called for in Department of Defense (DoD) 5000-series documents (DoDD 5000.01). Terms used in this Standard relating to the materiel acquisition process are limited to terms used in the DoD 5000-series documents; to avoid confusion and promote simplicity, service-specific terms/processes are not used.

3. **Part Two** contains environmental laboratory test methods to be applied according to the general and specific test tailoring guidelines described in Part One. It is important to emphasize that, with the exception of Method 528, these Methods are not to be called out in blanket fashion, nor applied as unalterable routines, but are to be selected and tailored to generate the most relevant test data possible. Methods 500 through 527 now contain the Note, "Tailoring is essential. Select methods, procedures and parameter levels based on the tailoring process described in Part One, paragraph 4.2.2, and Annex C. Apply the general guidelines for laboratory test methods described in Part One, paragraph 5 of this Standard." Prior to the start of testing, all deviations as a result of tailoring shall be approved by the proper authorities. It should further be noted that the rationale for such deviations and/or tailoring shall be recorded in the test report.

To support the tailoring process described in Part One, each test method in Part Two contains some environmental data and references, and identifies tailoring opportunities for the particular method. Some methods afford a wide latitude for tailoring; some can be tailored up to established limits, and some have relatively few tailoring options. Whenever possible, each method contains background rationale to help determine the appropriate level of tailoring. Each test method supports the test engineer and test facility operator by describing preferred laboratory test facilities and methodologies. Any specific tailoring information and values contained in these test methods should be supplanted by more up-to-date field/fleet or program-specific information when available.

When applied properly, the environmental management and engineering processes described in this Standard can be of enormous value in generating confidence in the environmental worthiness and overall durability of materiel system design. However, it is important to recognize that there are limitations inherent in laboratory testing that make it imperative to use proper caution and engineering judgment when extrapolating these laboratory results to results that may be obtained under actual service conditions. In many cases, real-world environmental stresses (singularly or in combination) cannot be duplicated practically or reliably in test laboratories. Therefore, users should not assume that a system or component that passes laboratory tests of this Standard also would pass field/fleet verification trials. DoD 5000-series documents call for component technology to be demonstrated in relevant environments to reduce risk on components and subsystems that have been demonstrated only in laboratory environments (DoDI 5000.02).

MIL-STD-810H
PART ONE

4. **Part Three** contains a compendium of climatic data and guidance assembled from several sources to include AR 70-38, “Research, Development, Test and Evaluation of Materiel for Extreme Climatic Conditions,” (1979), Draft AR 70-38 (1990) that was assembled using 1987 Air Land Battlefield Environment (ALBE) report information, “Environmental Factors and Standards for Atmospheric Obscurants, Climate, and Terrain,” and MIL-HDBK-310, Global Climatic Data for Developing Military Products.

Part Three provides planning guidance for realistic consideration (starting points) of climatic conditions in the research, development, test, and evaluation (RDTE) of materiel and materials used throughout their life cycles in various climatic regions throughout the world. It is intended that this and related documents will help achieve the objective of developing materiel that will perform adequately under the environmental conditions likely to be found throughout its life cycle in the areas of intended use.

5. The US Department of Defense would like to thank the following individuals for their contributions toward the development and publication of MIL-STD-810H:

Army	Air Force
Byron Alexander – Electronic Proving Ground	Dwayne Bell – Eglin AFB
Jimmie Barnett – Dugway Proving Ground	Cheryl Copes – ASC/ENRS, Wright-Patterson Air Force Base
Michael Barry – Aberdeen Test Center	Lorraine Wright – ASC/ENRS, Wright-Patterson Air Force Base
William (Bill) Barber – Redstone Test Center	Sean Mortara – ASC/ENFS, Wright-Patterson Air Force Base
Michael Bartosiak – SDDCTEA, Scott AFB	
Michael (Troy) Bedsole – Redstone Test Center	Navy
William (Skip) Connon – Aberdeen Test Center	Brian Haugen – NAWC, China Lake
Jeff Dallman – White Sands Missile Range	James E. Howell III – NSWC
Judy Galloway – Aberdeen Test Center	Andrew Johnson – NSWC, Dahlgren
Mike Hale – Redstone Test Center	Wayne Johnson – NAWC, Patuxent River
Anthony Ham – ATEC, APG	Ron Merritt – NAWC, China Lake
John Harris – Redstone Test Center	Luke Martin – NSWC, Dahlgren
Matthew Lucas – Redstone Test Center	Brett Tanner – NAWC, China Lake
Bob McKinnon – Aberdeen Test Center	
Joe Nash – AMRDEC	Private Industry
Randy Patrick – Yuma Test Center	Vesta Bateman – Mechanical Shock Consulting
Rick Reynaud – White Sands Missile Range	Chris Peterson – Consultant
Steve Sanders – AMRDEC	
Brendt Sigvart – Dugway Proving Ground	Organizations
Jamie Sullivan – Redstone Test Center	IEST – Institute of Environmental Sciences and Technology
Eric Tessier – White Sands Missile Range	SAVE – Shock and Vibration Exchange
Ken Thompson – ATEC, APG	
Scott Walton – Aberdeen Test Center	

The MIL-STD-810 Working Group wishes to recognize with great appreciation Mr. Ken Thompson, MIL-STD-810 Committee Chairman, for his exemplary leadership, guidance, and dedication to bringing this collaborative project to fruition.

MIL-STD-810H
PART ONE

6. This Standard is intended to be a "living document" that will be updated as new concepts, technologies, and methodologies evolve.

Questions about this document's technical content may be addressed to the following offices:

US Army Test and Evaluation Command, 2202 Aberdeen Blvd, ATTN: CSTE-TM, Aberdeen Proving Ground, MD 21005-5055; Commercial Tel: (443) 861-9338; DSN 848-9338; Fax: (443) 861-9927.

Aeronautical Systems Center, ATTN: ASC/ENFS, 2530 Loop Road West, Wright-Patterson AFB, OH 45433-7101; Commercial Tel: (937) 255-8517 or 904-5863; DSN 785-8517 or 674-5863; Fax: (937) 476-4546 or 255-2363.

Naval Air Warfare Center, Aircraft Division, ATTN: Code AIR-4.3.4, Patuxent River, MD 20670; Commercial Tel: (301) 342-8049; DSN 342-8049; Fax: (301) 757-1213.

Naval Air Warfare Center, Weapons Division, ATTN: Code 476300D, China Lake, CA 93555-6100; Commercial Tel: (760) 939-4667; DSN 437-4667; Fax: (760) 939-1065.

The Preparing Activity for MIL-STD-810 transferred from Air Force Code 11 to Army Code TE on 14 November 2008.

Comments, suggestions, or questions on this document should be addressed to US Army Test and Evaluation Command, 2202 Aberdeen Blvd, ATTN: CSTE-TM, Aberdeen Proving Ground, MD 21005-5001; or e-mailed to usarmy.apg.atec.mbx.atec-standards@mail.mil. Since contact information can change, you may want to verify the currency of this address information using the ASSIST Online database at <https://assist.dla.mil>.

MIL-STD-810H
PART ONE

CONTENTS

PART ONE -- ENVIRONMENTAL ENGINEERING PROGRAM GUIDELINES

<u>Paragraph</u>	<u>Page</u>
1. SCOPE	PART ONE-1
1.1 Purpose.....	PART ONE-1
1.2 Application.....	PART ONE-2
1.3 Limitations	PART ONE-3
2. APPLICABLE DOCUMENTS.....	PART ONE-4
2.1 General.....	PART ONE-4
2.2 Government Documents	PART ONE-4
2.2.1 Specifications, Standards, and Handbooks.....	PART ONE-4
2.2.2 Other Government Documents, Drawings, and Publications.....	PART ONE-5
2.3 Non-Government Publications.....	PART ONE-5
2.4 Order of Precedence.....	PART ONE-5
3. DEFINITIONS.....	PART ONE-5
3.1 Terms	PART ONE-5
3.2 Acronyms	PART ONE-8
4. GENERAL PROGRAM GUIDELINES.....	PART ONE-9
4.1 Program Managers	PART ONE-9
4.1.1 Roles of the Program Manager	PART ONE-9
4.1.2 Guidance for Program Managers	PART ONE-9
4.1.2.1 Concept of Operations (CONOPS)	PART ONE-11
4.1.2.2 System Requirements Document (SRD).....	PART ONE-11
4.1.2.3 Initial Capabilities Document (ICD).....	PART ONE-11
4.1.2.4 Capabilities Development Document (CDD).....	PART ONE-12
4.1.2.5 Capabilities Production Document (CPD)	PART ONE-12
4.1.2.6 System Engineering Management Plan (SEMP).....	PART ONE-12
4.1.2.7 Test and Evaluation Master Plan (TEMP)	PART ONE-12
4.2 Environmental Engineering Specialists (EES).....	PART ONE-12
4.2.1 Roles of Environmental Engineering Specialists.....	PART ONE-12
4.2.2 Environmental Engineering Tailoring Tasks	PART ONE-13
4.2.2.1 General.....	PART ONE-13
4.2.2.2 Preparing an Environmental Engineering Management Plan (EEMP), Task 401.....	PART ONE-13
4.2.2.3 Developing an Environmental Test and Evaluation Master Plan (ETEMP)	PART ONE-13
4.2.2.4 Preparing a Detailed Environmental Test Plan (DETP), Task 405	PART ONE-14
4.2.2.5 Preparing an Environmental Test Report (ETR), Task 406	PART ONE-14
4.3 Design and Test Engineers and Facility Operators	PART ONE-14
4.3.1 Roles of Design Engineers	PART ONE-14
4.3.2 Roles of Test Engineers/Facility Operators.....	PART ONE-14
4.3.3 Guidance for Design and Test Engineers and Test Facility Operators.....	PART ONE-14
4.3.3.1 Natural Environment (Field/Fleet) Testing	PART ONE-14
4.3.3.2 Laboratory Testing.....	PART ONE-14
5. GENERAL LABORATORY TEST METHOD GUIDELINES.....	PART ONE-17
5.1 Test Conditions	PART ONE-17
5.2 Tolerances for Test Conditions	PART ONE-17
5.3 Test Instrumentation.	PART ONE-18
5.3.1 Suitability for Environment.....	PART ONE-18
5.3.2 Calibration.....	PART ONE-18
5.4 Stabilizing Test Temperature.	PART ONE-18

MIL-STD-810H
PART ONE

CONTENTS - Continued

<u>Paragraph</u>	<u>Page</u>
5.4.1 Test Item Operating.	PART ONE-19
5.4.2 Test Item Non-Operating.	PART ONE-19
5.5 Test Sequence.	PART ONE-19
5.6 Test Level Derivation.....	PART ONE-19
5.7 Pretest Information for Facility Operators.	PART ONE-19
5.8 Test Setup.....	PART ONE-19
5.8.1 Installing the Test Item in Test Facility.	PART ONE-19
5.8.2 Test Item Operation.	PART ONE-20
5.9 Pretest Baseline Data.	PART ONE-20
5.10 Information During Test.	PART ONE-20
5.11 Interrupted Tests.	PART ONE-20
5.11.1 In-Tolerance Interruptions.	PART ONE-20
5.11.2 Out-of-Tolerance Interruptions.....	PART ONE-20
5.11.3 Interruption Due to Test Item Operation Failure.....	PART ONE-21
5.11.4 Scheduled Interruptions.	PART ONE-21
5.12 Combined Tests.	PART ONE-21
5.13 Post-Test Data.....	PART ONE-21
5.14 Environmental Effects and Failure Criteria.	PART ONE-23
5.15 Environmental Test Reports.....	PART ONE-23
5.16 Water Purity.....	PART ONE-23
5.17 Analysis of Results.....	PART ONE-23
5.18 Monitoring.	PART ONE-24
5.18.1 Monitoring Test Chamber Parameters.	PART ONE-24
5.18.2 Monitoring the Item Under Test.	PART ONE-24
5.19 Total High Temperature Exposure Duration.....	PART ONE-24
5.20 Temperature Change Rate.....	PART ONE-25
 6. NOTES.....	 PART ONE-25
6.1 Intended Use.	PART ONE-25
6.2 Acquisition Requirements.....	PART ONE-25
6.3 Subject Term (Key Word) Listing	PART ONE-25
6.4 International Standardization Agreement Implementation	PART ONE-26
6.5 Changes from Previous Issue.....	PART ONE-26

FIGURES

Figure 1-1. Environmental engineering program guide.....	PART ONE-1
Figure 1-2. Roles of acquisition personnel in environmental design/test tailoring process.....	PART ONE-2
Figure 1-3. Environmental test program tailoring process.....	PART ONE-10
Figure 1-4a. Generalized life cycle histories for military hardware	PART ONE-15
Figure 1-4b. Generalized life cycle histories for military hardware	PART ONE-16
Figure 1-5. Interrupted test cycle logic.....	PART ONE-22

<u>Annex</u>	<u>Page</u>
A Environmental Management and Engineering Tasks	PART ONE-A-1
Task 401 – Environmental Engineering Management Plan (EEMP).....	PART ONE-A-2
Task 402 – Life Cycle Environmental Profile (LCEP).....	PART ONE-A-3
Task 403 – Operational Environment Documentation (OED).....	PART ONE-A-15
Task 404 – Environmental Issues/Criteria List (EICL)	PART ONE-A-17
Task 405 – Detailed Environmental Test Plans (DETP)	PART ONE-A-18
Task 406 – Environmental Test Report (ETR).....	PART ONE-A-21
B Detailed Program Management Guidance	PART ONE-B-1

MIL-STD-810H
PART ONE

<u>Annex</u>	<u>Page</u>
C	Environmental Tailoring Guidelines for Environmental Engineering Specialists (EES)..... PART ONE-C-1
D	Terminology for Dynamic (Mechanical) Test Methods.....PART ONE-D-1

PART ONE, ANNEX C FIGURES

C-1	Areas of occurrence of climatic categories A1, A2, & A3..... PART ONE-C-5
C-2	Areas of occurrence of climatic categories B1, B2, & B3 PART ONE-C-6
C-3	Areas of occurrence of climatic categories C1, C2, & C3 PART ONE-C-7

PART ONE, ANNEX C TABLE

C-I	Summary of climatic conditions and daily cycles of temperature, solar radiation, and relative humidity..... PART ONE-C-8
C-II	Summary of potential environments for the Storage Phase PART ONE-C-9
C-III	Summary of potential environments for the Transportation Phase PART ONE-C-9
C-IV	Summary of potential environments for the Deployment Phase..... PART ONE-C-10

PART TWO -- LABORATORY TEST METHODS

<u>Paragraph</u>	<u>Page</u>
500.6	Low Pressure (Altitude) 500.6-i - 500.6-8
501.7	High Temperature..... 501.7-i - 501.7-14
502.7	Low Temperature 502.7-i - 502.7-10
503.7	Temperature Shock..... 503.7-i - 503.7-14
504.3	Contamination by Fluids 504.3-i - 504.3C-2
505.7	Solar Radiation (Sunshine)..... 505.7-i - 505.7C-9
506.6	Rain..... 506.6-i - 506.6-14
507.6	Humidity..... 507.6-i - 507.6A-2
508.8	Fungus..... 508.8-i - 508.8B-2
509.7	Salt Fog 509.7-i - 509.7-10
510.7	Sand and Dust 510.7-i - 510.7-18
511.7	Explosive Atmosphere..... 511.7-i - 511.7-10
512.6	Immersion..... 512.6-i - 512.6-8
513.8	Acceleration..... 513.8-i - 513.8A-8
514.8	Vibration..... 514.8-i - 514.8F-F2
515.8	Acoustic Noise 515.8-i - 515.8B-4
516.8	Shock..... 516.8-i - 516.8C-8
517.3	Pyroshock 517.3-i - 517.3A-10
518.2	Acidic Atmosphere..... 518.2-i - 518.2-8
519.8	Gunfire Shock 519.8-i - 519.8C-14
520.5	Combined Environments..... 520.5-i - 520.5A-3
521.4	Icing/Freezing Rain..... 521.4-i - 521.4-8
522.2	Ballistic Shock 522.2-i - 522.2-20
523.4	Vibro-Acoustic/Temperature..... 523.4-i - 523.4A-8
524.1	Freeze / Thaw..... 524.1-i - 524.1-6
525.2	Time Waveform Replication 525.2-i - 525.2B-10
526.2	Rail Impact 526.2-i - 526.2-10
527.2	Multi-Exciter Test 527.2-i - 527.2E-38
528.1	Mechanical Vibrations of Shipboard Equipment (Type I - Environmental and Type II - Internally Excited)..... 528.1-i - 528.1B-4

MIL-STD-810H
PART ONE

PART THREE -- WORLD CLIMATIC REGIONS – GUIDANCE

<u>Paragraph</u>	<u>Page</u>
1. SCOPE	PART THREE-1
2. DISTRIBUTION OF CLIMATIC DESIGN TYPES	PART THREE-3
3. NATURAL AND INDUCED ENVIRONMENT AND ASSOCIATED ELEMENTS	PART THREE-8
4. ENVIRONMENT ELEMENTS - CLIMATIC DESIGN TYPES - NATURAL AND INDUCED.	PART THREE-10
5. ADDITIONAL ENVIRONMENTAL ELEMENTS	PART THREE-25
6. REFERENCED / RELATED DOCUMENTS	PART THREE-39

PART THREE

Page

Annex

A Weather and Climatic Extremes – A Brief Summary	PART THREE A-1
B Terminology.....	PART THREE B-1
C Comparison of AR 70-38 with MIL-HDBK-310.....	PART THREE C-1

MIL-STD-810H
PART ONE

**PART ONE –
ENVIRONMENTAL ENGINEERING PROGRAM GUIDELINES**

1. SCOPE.

1.1 Purpose.

This Standard contains materiel acquisition program planning and engineering direction for considering the influences that environmental stresses have on materiel throughout all phases of its service life. It is important to note that this document does not impose design or test specifications. Rather, it describes the environmental tailoring process that results in realistic materiel designs and test methods based on materiel system performance requirements. Figure 1-1 summarizes this direction.

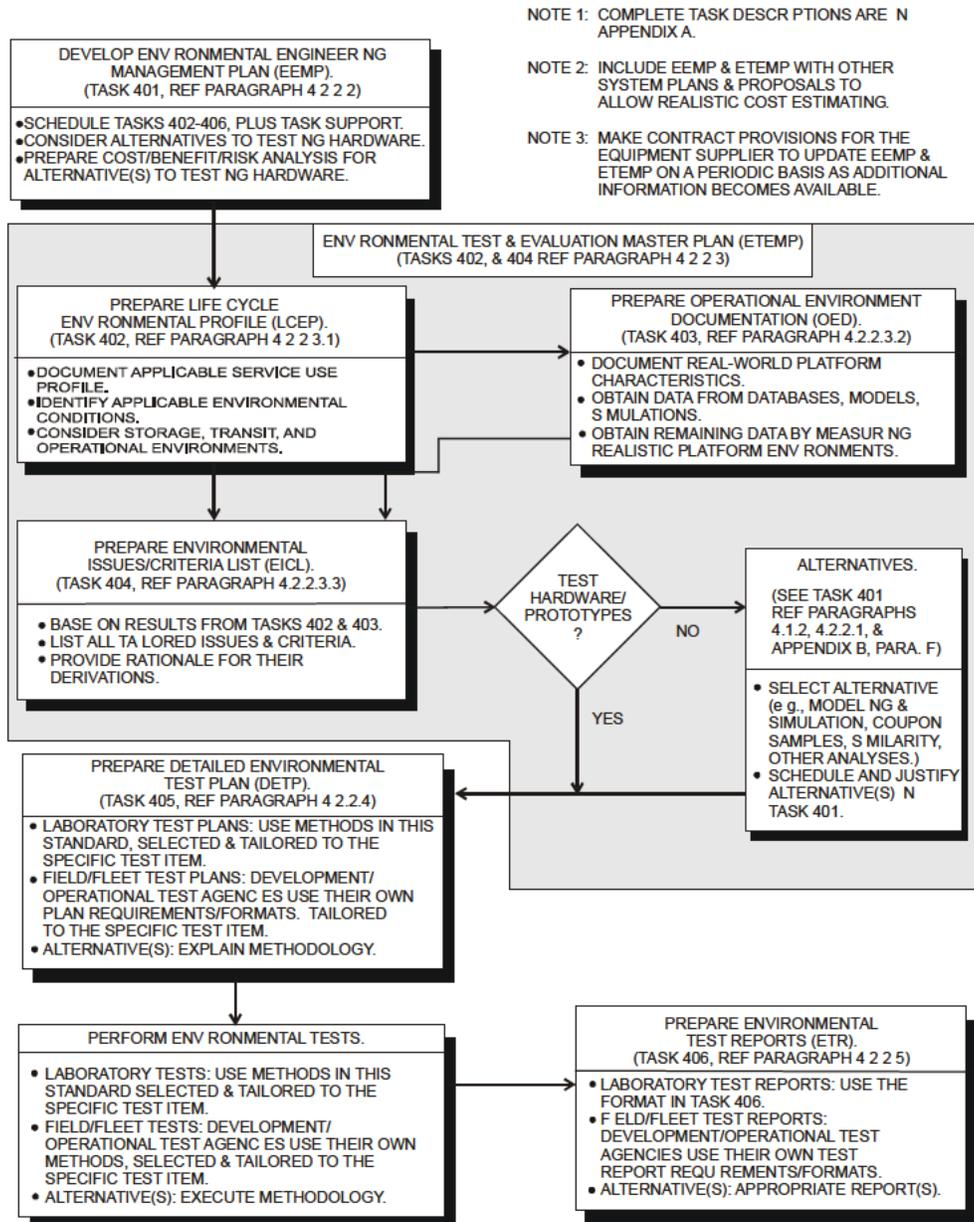


Figure 1-1. Environmental engineering program guide.

This document supports the functions of three different groups of personnel involved in the materiel acquisition process. Each of these groups is critical to the goal of successfully incorporating environmental considerations into

MIL-STD-810H
PART ONE

material design, test, and evaluation. Although each group has different tasks to perform, none of these tasks can be isolated from the others in a successful acquisition program. As shown on Figure 1-2, this information is intended for the following:

- Material acquisition Program Managers among whose responsibilities is ensuring materiel will function as required in intended operational environments. (See 4.1, below.)
- Environmental engineering specialists (EES) who assist the capability and materiel developers throughout the acquisition process to tailor their materiel designs and test designs to environmental stresses/constraints expected during the materiel's service life. (See 4.2, below.)
- Design, test, and evaluation community analysts, engineers, and facility operators who meet user needs by focusing on tailored designs and tests. (See 4.3, below, and Part Two of this Standard.)

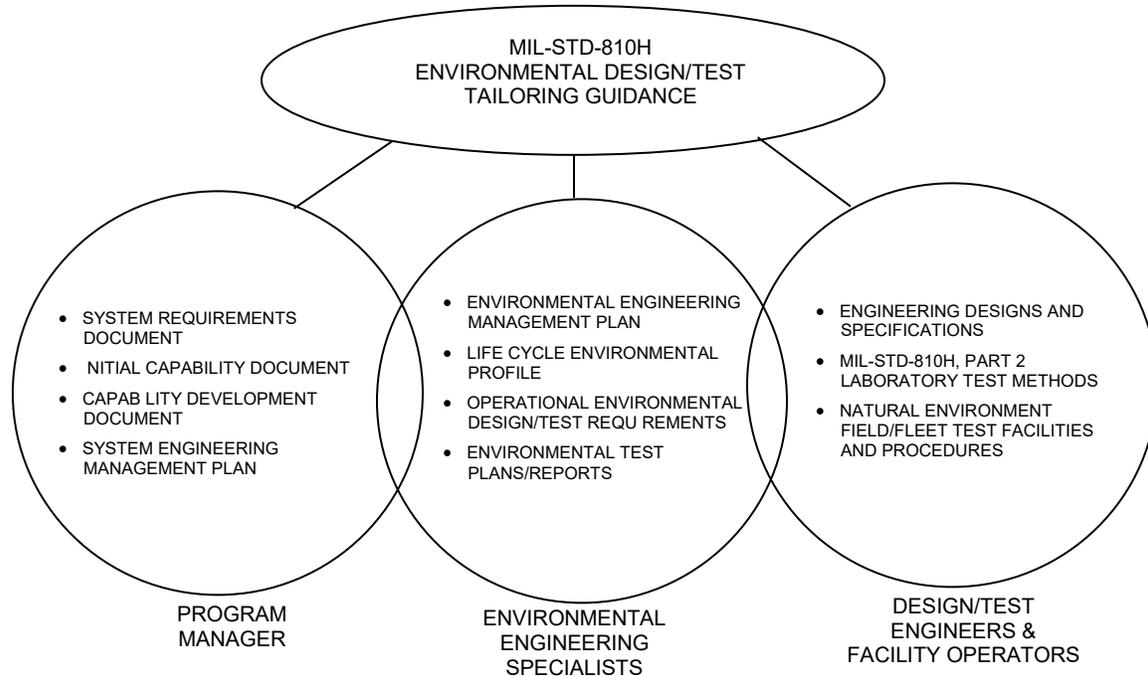


Figure 1-2. Roles of acquisition personnel in the environmental design/test tailoring process.

1.2 Application.

The tailoring process described in this Standard (i.e., systematically considering detrimental effects that various environmental factors may have on a specific materiel system throughout its service life) applies throughout the materiel acquisition cycle to all materiel developed for military or commercial applications, including foreign and non-development item (NDI) procurements, procurements, or modifications of Allied systems or materiel, and cooperative development opportunities with one or more Allied nations to meet user and interoperability needs (DODD 5000.01).

- Part One lays out a disciplined, tailored approach for acquiring systems that will withstand the stresses of climatic, shock and vibration environments that they expect to see in their service lives. The basic process for acquiring materiel that satisfies users' needs from this environmental engineering viewpoint is depicted on Figure 1-1.
- Part Two also is an integral part of the environmental tailoring process. It contains tailoring information, environmental stress data, and laboratory test methods. The environmental data contained in the Methods may help, but should not be used exclusively to define environmental stresses that materiel will encounter throughout its service life. This will help engineers to tailor analyses and tests to specific materiel and its defined life cycle. It is not valid to call out all of the Methods in this Standard in a blanket fashion for a materiel system; nor is it valid, once a Method is determined appropriate, (except for Method 528) to regard the environmental stress data, test criteria, and procedures in the Method as unalterable.

MIL-STD-810H
PART ONE

- c. Part Three provides planning guidance for realistic consideration (starting points) of climatic conditions in the research, development, test, and evaluation (RDTE) of materiel and materials used throughout their life cycles in various climatic regions throughout the world. It is intended that this and related documents will help achieve the objective of developing materiel that will perform adequately under the environmental conditions likely to be found throughout its life cycle in the areas of intended use.
- d. Guidance and test Methods of this Standard are intended to:
 - (1) Provide guidance of the development of materiel life cycles and aid in the development of environmental stress sequences, durations, and test levels.
 - (2) Be used to develop analysis and test criteria tailored to the materiel and its environmental life cycle.
 - (3) Evaluate materiel performance when exposed to a life cycle of environmental stresses.
 - (4) Identify deficiencies, shortcomings, and defects in materiel design, materials, manufacturing processes, packaging techniques, and maintenance methods.
 - (5) Demonstrate compliance with contractual requirements.
- e. For the purpose of this document the following shall apply for Mandatory, Recommended, Guidance, and Optional Words:
 - (1) The word “shall” establishes a requirement.
 - (2) The word “will” establishes a declaration of purpose on the part of the design activity.
 - (3) The word “should” establishes a recommended practice.
 - (4) The word “may” establishes an allowed practice.
 - (5) The words “typical,” “example,” “for reference,” or the Latin abbreviation “e.g.” indicate suggestions given for guidance only.
 - (6) The word “or” used in conjunction with a requirement or a recommended practice indicates that there are two or more options for complying with the stated requirement or practice.

1.3 Limitations.

Although environmental analysis, design analysis, and laboratory testing are valuable tools in the materiel acquisition process, there are inherent limitations in analysis and laboratory testing techniques that must be recognized. The methods in Part Two of this Standard do not include many of the naturally-occurring forcing functions that may affect materiel performance or integrity in service use. Further, analytic and laboratory test methods are limited in their abilities to simulate synergistic or antagonistic stress combinations, dynamic (time sequence) stress applications, aging, and other potentially significant stress combinations present in natural field/fleet service environments. Use caution when defining and extrapolating analyses, test criteria, and results. Part Two test methods purposely do not address the following but may, in some cases, be applied:

- a. Electromagnetic interference (EMI).
- b. Lightning and magnetic effects.
- c. Nuclear, biological, chemical weapons or their effects.
- d. Certain aspects of munitions and pyrotechnics safety testing.
- e. Piece parts such as bolts, wires, transistors and integrated circuits.
- f. Packaging performance or design.
- g. Suitability of clothing or fabric items that are described in specific specifications.
- h. Environmental stress screening (ESS) methods and procedures.
- i. Reliability testing.
- j. Safety testing.
- k. Space – region beyond Earth’s atmosphere

MIL-STD-810H
PART ONE

2. APPLICABLE DOCUMENTS.

2.1 General.

The documents listed in this section are specified in sections 3, 4, or 5 of this Standard. This section does not include documents cited in other sections of this Standard or recommended for additional information or as examples. While every effort has been made to ensure the completeness of this list, document users are cautioned that they must meet all specified requirements of documents cited in sections 3, 4, or 5 of this Standard, whether or not they are listed.

2.2 Government Documents.

2.2.1 Specifications, Standards, and Handbooks.

The following specifications, standards, and handbooks form a part of this document to the extent specified herein. Unless otherwise specified, the issues of these documents are those cited in the solicitation or contract.

INTERNATIONAL STANDARDIZATION AGREEMENTS

STANAG 4370	Environmental Testing
(STANAG 4370)	Allied Environmental Conditions and Test Publications (AECTPs)
AECTP 100	Environmental Guidelines for Defence Materiel
AECTP 200	Environmental Conditions
AECTP 230	Climatic Conditions
AECTP 240	Mechanical Environmental Testing
AECTP 300	Climatic Environmental Tests
AECTP 400	Mechanical Environmental Tests

(Copies of these documents are available online at [ASSIST](https://assist.dla.mil) (<https://assist.dla.mil>) or the [North Atlantic Treaty Organization Online Library](#).

DEPARTMENT OF DEFENSE SPECIFICATIONS

MIL-DTL-901	Shock Tests, H.I. (High Impact) Shipboard Machinery, Equipment, and Systems, Requirements for
-------------	---

(Copies of these documents are available online at [ASSIST](https://assist.dla.mil) (<https://assist.dla.mil>).

DEPARTMENT OF DEFENSE STANDARDS

MIL-STD-167-1	Mechanical Vibrations of Shipboard Equipment (Type I – Environmental, and Type II – Internally Excited)
MIL-STD-331	Fuze and Fuze Components, Environmental and Performance Tests for
MIL-STD-704	Aircraft Electrical Power Characteristics
MIL-STD-882	Standard Practice for System Safety
MIL-STD-1275	Characteristics of 28 Volt D Electrical Systems in Military Vehicles
MIL-STD-1399	Interface Standard for Shipboard Systems
MIL-STD-2105	Hazard Assessment Tests for Non-Nuclear Munitions

(Copies of these documents are available online at [ASSIST](https://assist.dla.mil) (<https://assist.dla.mil>).

DEPARTMENT OF DEFENSE HANDBOOKS

MIL-HDBK-310	Global Climatic Data for Developing Military Products
--------------	---

(Copies of these documents are available online at [ASSIST](https://assist.dla.mil) (<https://assist.dla.mil>).

MIL-STD-810H
PART ONE**2.2.2 Other Government Documents, Drawings, and Publications.**

The following other Government documents, drawings, and publications form a part of this document to the extent specified herein. Unless otherwise specified, the issues of these documents are those cited in the solicitation or contract.

DEPARTMENT OF DEFENSE DIRECTIVES, INSTRUCTIONS, AND REGULATIONS

DODD 5000.01 The Defense Acquisition System

DODI 5000.02 Operation of the Defense Acquisition System

(Copies of these two documents are available online at [The Defense Technical Information Center Website](#), and are available from DTIC Headquarters, 8725 John J. Kingman Rd., Ft. Belvoir VA 22060-6218; telephone (800) 225-3842.)

AR 70-38 Research, Development, Test and Evaluation of Materiel for Extreme Climatic Conditions

(Copies of this Army Regulation are available online at [The Army Publishing Directorate Website](#), and are available from the US Army Publications Distribution Center, 1655 Woodson Rd., St Louis, MO 63114-6181; telephone [314] 263-7305.)

2.3 Non-Government Publications.

The following documents form a part of this document to the extent specified herein. Unless otherwise specified, the issues of these documents are those cited in the solicitation or contract.

AMERICAN NATIONAL STANDARDS INSTITUTE (ANSI)/
NATIONAL CONFERENCE OF STANDARDS LABS (NCSL)

ANSI/NCSL Z540.1 General Requirements for Calibration Laboratories and Measuring and Test Equipment

(Copies of this document are available online at [The NCSL International Website](#), or from NCSL International, 2995 Wilderness Place, Suite 107, Boulder, Colorado 80301-5404; telephone (303) 440-3339.)

INTERNATIONAL ORGANIZATION FOR STANDARDIZATION (ISO)

ISO 10012-1 Measurement Management Systems – Requirements for Measurement Processes and
Measuring Equipment

(Copies of this document are available online at [The ANSI E-standards Store](#) and [The International Organization for Standardization Website](#), or from ANSI, 25 West 43rd Street, 4th Floor, New York NY 10036-7406; telephone [212] 642-4900.)

2.4 Order of Precedence.

Unless otherwise noted herein or in the contract, in the event of a conflict between the text of this document and the references cited herein, the text of this document takes precedence. Nothing in this document, however, supersedes applicable laws and regulations unless a specific exemption has been obtained.

3. DEFINITIONS.**3.1 Terms.**

This terminology section is meant to define the general terminology as it is used in this standard. In certain cases the terminology use may be somewhat different from its use in the general engineering community. No attempt has been made to be complete, therefore limiting the glossary to such terms as are found in the standard and that are important to the application of the standard. Terminology unique to a particular method is defined, as appropriate, in that method.

NOTE: A continuation of this terminology section that contains terminology more closely related to the dynamic (mechanical) test methods such as vibration, shock, gunfire shock, etc., is in Part One, Annex D.

- a. **Absolute humidity.** The density of water in a particular volume of air. The most common units are grams per cubic meter, although any mass unit and any volume unit could be used. Warm air can hold more water vapor than cold air.

MIL-STD-810H
PART ONE

- b. **Accelerated test.** A test designed to shorten the controlled environmental test time with respect to the service use time by increasing the frequency of occurrence, amplitude, duration, or any combination of these of environmental stresses that would be expected to occur during service use.
- c. **Aggravated test.** A test in which one or more conditions are set at a more stressful level than the materiel will encounter during service use.
- d. **Ambient environment.** The conditions, either outdoor or confined (e.g., temperature and humidity), that characterize the air or other medium that surrounds materiel.
- e. **Climatic categories.** Specific types of world climates in which materiel is designed to withstand during operation, storage, and transit. See Part One, Annex C, Table C-I and Figure C-1.
- f. **Combat developer.** Military specialist concerned with training, doctrine, and materiel needs documentation.
- g. **Critical threshold value.** The level of an environment forcing function that degrades the capability of materiel significantly or requires degradation prevention measures be taken.
- h. **Cumulative effects.** The collective consequences of environmental stresses during the life cycle of materiel.
- i. **Detailed Environmental Test Plan (DETP).** Detailed plans for conducting environmental tests required to determine if the environmental criteria developed in Task 404 are met and their associated critical issues are satisfied, and to identify critical environmental threshold values for system effectiveness that may be evident during testing
- j. **Engineering judgment.** Expert opinion based on engineering education and experience, especially in the area in which the judgment is made.
- k. **Environmental analysis.** Technical activity covering an analytical description of the effects that various environments have on materiel, subsystems, and component effectiveness.
- l. **Environmental conditions.** (See Forcing function (environment).)
- m. **Environmental engineering.** The discipline of applying engineering practices to the effects that various environments have on materiel effectiveness.
- n. **Environmental engineering specialist (EES).** A person or group of people skilled in one or more environmental engineering areas. Areas include, but are not necessarily limited to: natural and induced environments and their effects on materiel; expertise in measuring and analyzing in-service environmental conditions; formulating environmental test criteria; determining when environmental laboratory tests are appropriate/valid substitutes for natural in-service environmental tests; and evaluating the effects of specific environments on materiel. (See 4.2.)
- o. **Environmental test.** A structured procedure to help determine the effects of natural or induced environments on materiel.
- p. **Environmental worthiness.** The capability of materiel, subsystem, or component to perform its full array of intended functions in intended environments.
- q. **Equipment.** For purposes of this standard (with the exception of Method 528), equipment includes the instrumentation, facilities, and support apparatus used to conduct or monitor tests. This does not include the test item itself or the materiel of which the test item is a sample or a part.
- r. **Exaggeration factors.** The ratio of the test condition severity to the in-service severity and is used to develop a time compression factor for a particular failure mode.
- s. **External Store.** Any device intended for internal or external carriage and mounted on aircraft suspension and release equipment, whether or not the item is intended to be separated in flight from the aircraft. Aircraft stores are classified in two categories as follows: a. expendable store - An aircraft store normally separated from the aircraft in flight such as a missile, rocket, bomb, nuclear weapon, mine, torpedo, pyrotechnic device, sonobuoy, signal underwater sound device, or other similar items; b. nonexpendable store - An aircraft store that is not normally separated from the aircraft in flight such as a tank (fuel and spray), line-source disseminator, pod (refueling, thrust augmentation, gun, electronic attack, data link, etc.), multiple rack, target, cargo drop container, drone, or other similar items. (From Dictionary of Military and Associated Terms. US Department of Defense, 2005.)
- t. **Forcing function (environment).** A natural or induced physical environmental stress condition on materiel that may affect its ability to function as intended or to withstand transit or storage during its service life. (Also referred to as an environmental condition or an environmental stress.)

MIL-STD-810H
PART ONE

- u. **Frequency of occurrence.** Refers to the process used to differentiate among daily cycles of the climatic design types; i.e., the empirical result observed in real world data. It is based on tabulations and binning of hourly temperatures obtained over many years of observations at data reporting sites. The delineation of the areas shown in Part One, Annex C (A1, A2, and A3 shown in Figure C-1, areas B1, B2, and B3 shown in Figure C-2, and areas C0, C1, and C2 shown in Figure C-3), is based on temperatures occurring one percent of the time (approximately 7.4 hours) in the worst month of the year. For the Severe Cold category (C3), the temperatures shown are those that could equal or exceed -51°C (-60°F) 20 percent of the time in the coldest month. The spatial extent and boundaries appearing in Figure C-3 are generalizations. They are based on the data availability and the spatial density of the climatic stations used in their construction. Both climatic and geographic principles were used in their derivation. However, they should be regarded as approximations.
- v. **Hermetic seal.** A permanent, air-tight seal.
- w. **Induced environment.** An environmental condition that is predominantly man-made or generated by the materiel platform. Also, refers to any condition internal to materiel that results from the combination of natural environmental forcing functions and the physical/chemical characteristics of the materiel itself.
- x. **In-service use.** The anticipated use of materiel during its intended service use life.
- y. **Integrated Product Team (IPT).** A group of individuals from different professional disciplines and organizations (government and industry) who work together on a product from concept through production stages. Individuals who cover a discipline may change from stage to stage, but the discipline is covered, and the information pertinent to that discipline is passed to the succeeding team member(s) in that discipline.
- z. **Life Cycle Environmental Profile (LCEP).** Design and test decision baseline document outlining real-world, platform-specific, environmental conditions that a specific materiel system or component will experience during service-related events (e.g., transportation, storage, operational deployment/use) from its release from manufacturing to the end of its useful life.
- aa. **Life cycle profile.** A time history of events and conditions associated with materiel from its release from manufacturing to its removal from service, including demilitarization. The life cycle should include the various phases materiel will encounter in its life, such as: packaging, handling, shipping, and storage prior to use; mission profiles while in use; phases between missions such as stand-by or storage, transfer to and from repair sites and alternate locations; and geographical locations of expected deployment.
- bb. **Material.** The physical constituents comprising materiel, e.g., metals, plastics, cloth, paper, etc.
- cc. **Materiel.** A commodity or set of commodities. With the exception of Method 528, a generic class of hardware designed to perform a specific function. All items (including ships, tanks, self-propelled weapons, aircraft, etc., and related spares, repair parts, and support equipment, but excluding real property, installations, and utilities) necessary to equip, operate, maintain, and support military activities without distinction as to its application for administrative or combat purposes.
- dd. **Materiel developer.** An agency or group of individuals involved in designing, testing, or evaluating materiel to meet developer performance requirements.
- ee. **Mission profile.** That portion of the life cycle profile associated with a specific operational mission.
- ff. **Operational check.** This is a failure finding task to determine if an item is fulfilling its intended purpose. Means to operate the materiel or component as usual (all modes and functions) and determine whether or not it is useable for its intended purpose.
- gg. **Operational worthiness.** The capability of materiel, a subsystem, or component to perform its full array of intended functions.
- hh. **Parameter.** Any quantity that represents a descriptive generalization of a certain characteristic physical property of a system that has a certain value at a particular time.
- ii. **Parameter level.** The value of a physical property that documents the degree, extent, or level at which a parameter exists at a given location at a given point in time, or the value to which a variable test control is set (see test level).
- jj. **Platform.** Any vehicle, surface, or medium that carries the materiel. For example, an aircraft is the carrying platform for installed avionics items or transported or externally mounted stores. The land is the platform for a ground radar set, for example, and a person for a man-portable radio.

MIL-STD-810H
PART ONE

- kk. **Platform environment.** The environmental conditions materiel experiences as a result of being attached to or loaded onto a platform. The platform environment is influenced by forcing functions induced or modified by the platform and any platform environmental control systems.
- ll. **Probability of occurrence.** The measure of how likely it is that some event will occur. It is the theoretical distribution and not the actual distribution of the temperatures themselves. It is similar to a sample mean from a data set versus the actual mean of the underlying distribution from which the sample is drawn.
- mm. **Program Manager.** The (Government) official who is in charge of the acquisition process for the materiel.
- nn. **Relative humidity.** The ratio of the actual vapor pressure of the air to the saturation vapor pressure. Source: American Meteorological Society. (1959). *Glossary of Meteorology*. Boston: AMS Relative humidity (RH) indicates the degree of saturation of the air.
- oo. **Service life.** Period of time from the release of materiel from the manufacturer through retirement and final disposition.
- pp. **Tactical standby to operation.** The term “tactical” is used here to identify materiel that is not in storage, but is in a standby operational configuration, and as such is subjected to extended non-operational conditions immediately prior to operation.
- qq. **Tailoring.** The process of choosing design characteristics/tolerances and test environments, methods, procedures, sequences and conditions, and altering critical design and test values, conditions of failure, etc., to take into account the effects of the particular environmental forcing functions to which materiel normally would be subjected during its life cycle. The tailoring process also includes preparing or reviewing engineering task, planning, test, and evaluation documents to help ensure realistic weather, climate, and other physical environmental conditions are given proper consideration throughout the acquisition cycle.
- rr. **Temperature shock.** A change rate in temperature greater than or equal to 10° C (18° F) per minute.
- ss. **Test item.** Specific materiel, a subsystem, or component being tested, including its container and packaging materials, that is representative of the materiel being developed. A representative sample of materiel that is used for test purposes.
- tt. **Test level.** The value at which a test condition is set or recorded. (Also, see parameter level.)
- uu. **Test method.** The criteria and procedures used to formulate an environmental test. Laboratory test methods are identified by the environment (or combinations of environments) in Part Two of this document.
- vv. **Test plan.** A document that may include test procedures and test levels, failure criteria, test schedules, and operational and storage requirements.
- ww. **Test procedure.** A sequence of actions that prescribes the exposure of a test item to a particular environmental forcing function or combination of environmental forcing functions, as well as inspections, possible operational checks, etc.
- xx. **Time compression.** The process of increasing the rate of degradation of materiel in a quantitative manner. The goal is to shorten the test time by increasing the severity of the environment using a physics-based method that retains the correct failure mechanisms without inducing others.

3.2 Acronyms.

Acronyms used in this document are defined below.

AECTP	Allied Environmental Conditions and Test Publication
ANSI	American National Standards Institute
CDD	Capability Development Document
COEA	Cost and Operational Effectiveness Analysis
CONOPS	Concept of Operations
CPD	Capabilities Production Document
DETP	Detailed Environmental Test Plan
DOD	Department of Defense
DODD	Department of Defense Directive
DODI	Department of Defense Instruction
DODISS	Department of Defense Index of Specifications and Standards
DTIC	Defense Technical Information Center
EEMP	Environmental Engineering Management Plan
EES	Environmental Engineering Specialists

MIL-STD-810H
PART ONE

EICL	Environmental Issues/Criteria List
EMI	Electromagnetic Interference
ESS	Environmental Stress Screening
ETEMP	Environmental Test and Evaluation Master Plan
ETR	Environmental Test Report
ICD	Initial Capability Document
IPT	Integrated Product Team
ISO	International Organization for Standardization
LCEP	Life Cycle Environmental Profile
MAIS	Major Automated Information System
MDAP	Mandatory Procedures for Major Defense Acquisition Program
MIL-HDBK	Military Handbook
MIL-STD	Military Standard
NATO	North Atlantic Treaty Organization
NCSL	National Conference of Standards Laboratories
NDI	Non-development Item
OED	Operational Environment Documentation
OEDP	Operational Environment Documentation Plan
OEDR	Operational Environment Documentation Report
SEMP	System Engineering Management Plan
SRD	System Requirements Document
STANAG	Standardization Agreement (NATO)
TEMP	Test and Evaluation Master Plan

4. GENERAL PROGRAM GUIDELINES.

4.1 Program Managers.

4.1.1 Roles of the Program Manager.

In the context of this Standard, the Program Manager's primary role is to ensure environmental engineering considerations are addressed systematically, thoroughly, and effectively at appropriate times throughout the materiel acquisition process. The process for accomplishing this integration is diagrammed on Figure 1-1. An associated role is to ensure environmental effects information is documented, available, and communicated from one program phase to another.

4.1.2 Guidance for Program Managers.

- a. DOD 5000-series documents call for a total systems approach through systems engineering, considering all life cycle needs, including storage, transport, and operation in natural environments (DODD 5000.01). Specifically, they call for a description of how performance in natural environmental conditions representative of the intended area of operations will be tested. This includes identifying test beds that are critical to determine if developmental test objectives are achieved, taking into account such stressors as temperature, vibration (random or sinusoidal), pressure, humidity, fog, precipitation, clouds, electromagnetic environment, blowing dust and sand, icing, wind conditions, steep terrain, wet soil conditions, high sea state, storm surge and tides, etc. (DODI 5000.02). The environmental tailoring process shown on Figure 1-3, and the generalized life cycle environmental profile on Figures 1-4a and b use systems engineering approaches, helping to ensure that system design and test criteria are tailored to environmental conditions within which materiel systems are to operate.

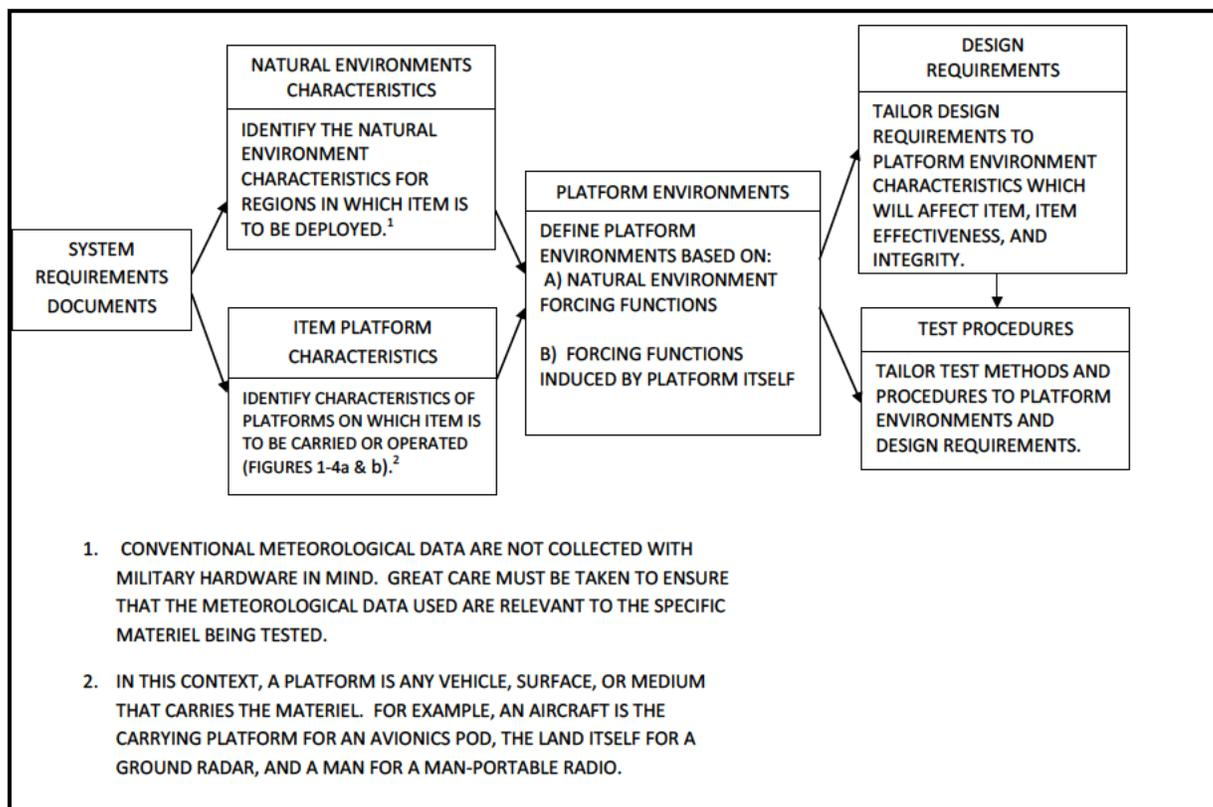
MIL-STD-810H
PART ONE

Figure 1-3. Environmental test program tailoring process.

- b. As indicated on Figure 1-1, there may be times that the Program Manager has valid alternatives to testing actual hardware or hardware prototypes when conducting laboratory, development, or operational tests. These alternatives include, but are not necessarily limited to, using simulation to reduce the costs involved in producing and testing hardware prototypes, using coupon samples instead of entire systems when specific materials are the central acquisition issue, and using analytical procedures such as verification by similarity to systems already tested and approved. An Environmental Engineering Specialist (EES) can aid Program Managers to establish an engineering basis for selecting such alternatives. When these alternatives are selected, Task 401, Environmental Engineering Management Plan, must contain the rationale for their selection, including an explanation of expected cost savings, other benefits and risks to system effectiveness/safety. (See Part One, Annex A, Task 401; and Annex B, paragraph F.)
- c. Whole Life Assessment (WLA) principles should be considered by the Program Manager during the development of a test program as a means to assess an item's safety, reliability, and performance throughout its intended life. WLA should include both an initial test program prior to entering service followed by a surveillance program while the item is in service. Initial testing may consist of Qualification and if applicable, Safe and Suitable for Service (S3) testing. In assessing the results of the initial test program, it is necessary to assign some form of service life to the item. This is a prediction of the amount of environmental stress the item should be able to withstand without degrading to an unsafe condition based on a risk assessment. These predictions are less likely to be valid the longer an item stays outside of a controlled storage environment as the environment becomes more variable. A well-defined and regimented surveillance plan such as In Service Surveillance (ISS) or a Stockpile Reliability Program (SRP) provides the means by which initial service life estimations can be confirmed, or modified, to ensure safe and reliable use throughout the required service life. There are two commonly accepted approaches to WLA. One approach would be to conduct initial qualification and S3 (if applicable) testing consistent with the LCEP followed by a well-defined and regimented surveillance plan such as In Service Surveillance (ISS) or a Stockpile Reliability Program (SRP). The other would be to expose the item to greater stresses than would be normally encountered in its life cycle

MIL-STD-810H
PART ONE

during the initial test program followed by a less rigorous surveillance plan. Both approaches are acceptable and have equal merit providing they are approved by the appropriate authority.

The following paragraphs, organized by major acquisition documents, capsule environmental effects information for Program Managers and serve as background information for design engineers, test engineers, and environmental engineering specialists. Annex B provides detailed direction for Program Managers.

4.1.2.1 Concept of Operation (CONOPS).

A Concept of Operations (CONOPS) is a verbal or graphic statement of a commander's assumptions or intent in regard to an operation or series of operations as defined by Joint Publication 1-02 DOD Dictionary of Military and Associated Terms. It's designed to give an overall picture of an operation.

In Acquisitions, a CONOPS is used to examine current and new and/or proposed capabilities required to solve a current or emerging problem. It describes how a system will be used from the viewpoints of its various stakeholders. This provides a bridge between the often vague capabilities that a project begins with and the specific technical requirements needed to make it successful. A CONOPS is a useful tool that helps the user community write/refine their Initial Capabilities Documents (ICD), System Requirements Document (SRD) and Capabilities Development Documents (CDD). There are several reasons for developing a Concept of Operations:

- a. Get stakeholder agreement identifying how the system is to be operated, who is responsible for what, what are the lines of communication;
- b. Define the high-level system concept and justify that it is superior to the other alternatives;
- c. Define the environment in which the system will operate;
- d. Derive high-level requirements in the ICD and CDD;
- e. Provide the criteria to be used for validation of the completed system

Checklist: Critical Information for developing a CONOPS

- a. Is the reason for developing the system clearly stated?
- b. Are all the stakeholders identified and their anticipated roles described?
- c. Are alternative operational approaches described and the selected approach justified?
- d. Is the external environment described?
 - o Does it include required interfaces to existing systems?
- e. Is the support environment described?
 - o Does it include maintenance?
- f. Is the operational environment described?

4.1.2.2 System Requirements Document (SRD).

The SRD defines system level functional and performance requirements for a system. The SRD is derived from the Concept of Operations (CONOPS), system-level performance metrics, mission threads/use cases, and usage environment and is developed by the program office. It's developed during the Technology Development (TD) Phase. When required, the SRD may also be known as the system performance specification or the system specification.

In identifying required capabilities and critical system characteristics, the CDD describes mission, storage, handling, and transport scenarios that the materiel will experience throughout its service life as shown on Figures 1-4a & b. In so doing, broad performance requirements (e.g., design for worldwide deployment) that may conflict with tailored issues can be avoided. This input to the CDD, covering natural and man-made environments and expected mission capabilities in those environments, is derived from the fundamental aspects of a Life Cycle Environmental Profile (LCEP). The LCEP, prepared through the assistance of an EES as described in Task 402 in Part One, Annex A, supports development of the CONOPS, SRD, ICD, CDD and the CPD.

4.1.2.3 Initial Capabilities Document (ICD).

The ICD, superseded the old Mission Needs Statement, documents one or more new capability requirements and associated capability gaps. The ICD also documents the intent to partially or wholly address identified capability

MIL-STD-810H
PART ONE

gap(s) with a non-materiel solution, materiel solution, or some combination of the two. An EES can assist the Program Manager in formulating this environmental effects input to the ICD.

4.1.2.4 Capabilities Development Document (CDD).

The CDD, superseded the Operational Requirements Document, defines authoritative, measurable, and testable parameters across one or more increments of a materiel capability solution, by setting KPPs, KSAs, and additional performance attributes necessary for the acquisition community to design and propose systems and to establish programmatic baselines.

4.1.2.5 Capabilities Production Document (CPD).

The Capability Production Document (CPD) captures the information necessary to support production, testing, and deployment of an affordable and supportable increment within an acquisition strategy. The CPD identifies, in threshold/objective format, the specific attributes that contribute most significantly to the desired operational capability. The CPD is prepared during the Engineering, Manufacturing & Development (EMD) Phase to guide the Production and Deployment phase after the Critical Design Review (CDR) and is used to measure the contractor's delivery. The CPD is required for the Milestone C Review and must be certified prior to a program proceeding into the Production and Development (PD) Phase.

4.1.2.6 System Engineering Management Plan (SEMP).

Program Managers integrate environmental technical considerations (effects of various environments on system performance and reliability) into the SEM. The mechanism for accomplishing this integration is provided in Task 401 in the form of an Environmental Engineering Management Plan (EEMP) prepared with the assistance of an EES. The EEMP basically lays out a schedule for implementing the remaining environmental engineering tasks, Tasks 402 through 406.

4.1.2.7 Test and Evaluation Master Plan (TEMP).

The TEMP includes plans for testing in natural (field/fleet) environments, simulated (laboratory) environments and a software model based environment. An EES assists the Program Manager in preparing the TEMP by developing an Environmental Test and Evaluation Master Plan (ETEMP), the preparation of which may be merged into the Integrated Test Program Schedule. Annex C provides information on the balance of field/fleet tests, laboratory tests, and modeling/simulation, and on the values chosen as design criteria or test criteria. Part Two of this Standard provides details for developing laboratory test procedures. Component parts of the ETEMP are Tasks 402 through 404. Thus, the ETEMP contains the following:

- a. Life Cycle Environmental Profile (LCEP) displaying the series of events, and environmental conditions derived from those events that materiel is expected to experience from manufacturing release to the end of its useful life. Include the system description in the TEMP. (See Task 402.)
- b. Operational Environment Documentation Plan (OEDP) outlining plans for obtaining specific natural or platform environment data to be used in developing tailored environmental test criteria. The OEDP does not have to be included in the TEMP, but is a necessary subtask within the ETEMP for creating a valid basis for environmental test criteria. (See Task 403.)
- c. Environmental Issues and Criteria List (EICL) containing fundamental environmental design and test criteria derived from the tailoring process. Include criteria in the required technical and operational characteristics of the TEMP. Include related critical issues in the TT&E or OT&E outline of the TEMP. (See Task 404.)

4.2 Environmental Engineering Specialists (EES).

EES are government or industry professionals in the acquisition process whose experience allows them to support Program Managers by helping to perform the tasks in Annex A. Their backgrounds may span many scientific/engineering disciplines. They already exist in Government and contractor agencies involved in the acquisition process (e.g., serving as design, test, and reliability engineers/scientists). Several EES of different backgrounds may work on an integrated product team (IPT) at one time or in sequence throughout the program, employed by or on contract to agencies of the services as appropriate at the time. Their work is documented and passed on through the products of each successive task.

4.2.1 Roles of Environmental Engineering Specialists.

EES from agencies within and on contract to government agencies support Program Managers throughout the acquisition cycle. EES are assigned by agencies that are responsible for performing the tasks outlined on Figure 1-1 and explained in detail in Part One, Annex A. EES should be involved early in the acquisition process, serving as

MIL-STD-810H
PART ONE

critical sources of environmental effects expertise and as technical facilitators throughout the entire acquisition process as part of an IPT. As shown on Figure 1-2, EES form facilitating bridges among design and test needs of Program Managers and technical procedures used by testers. The primary mechanisms for accomplishing environmental engineering goals are the tailoring tasks described below.

4.2.2 Environmental Engineering Tailoring Tasks.

4.2.2.1 General.

- a. Environmental engineering tailoring tasks are the basic strategy and structure for integrating environmental considerations into acquisition programs. The task sequence outlined on Figure 1-1 is designed to meet the environmental effects integration called for in the DOD 5000 series documents. To accomplish this integration, EES personnel working for government or contractor staffs throughout the acquisition process help to perform these environmental engineering tasks to help create a scientifically sound, cost effective design and test program in the area of environmental effects. This process, including the hardware test alternatives indicated on Figure 1-1, applies to all materiel developed for, or intended to be used by the military or industry. Detailed task descriptions are in Annex A.
- b. As indicated in 4.1, above, the primary benefits of performing these tasks come from the technical information and structure they provide for the CONOPS, SRD, ICD, CDD, CPD, SEMP, and TEMP. This information covers natural and induced environmental conditions. The structure provides an orderly means of uncovering potentially significant environmentally-related failures during the acquisition cycle rather than after fielding (storage, transit, and operational modes). The environmental engineering tasks then help reduce total ownership costs in terms of decreasing early system failures, reducing system downtime, saving repair/parts/logistic expenses, and even saving lives.

4.2.2.2 Preparing an Environmental Engineering Management Plan (EEMP), Task 401.

The EEMP is the basic management schedule used to integrate environmental effects considerations into the SEMP. This integration helps ensure materiel will be prepared for all environmental conditions to which it will be subjected during its life cycle. The EEMP identifies manpower, dollar estimates, timing and points of contact necessary to complete the remaining tasks (402 through 406). As indicated on Figure 1-1; 4.1.2; and Annex B, paragraph F, there may be times that the Program Manager has valid alternatives, such as modeling and simulation or other analytic techniques, to testing actual materiel or working prototypes. These alternatives are scheduled and justified in the EEMP. The EEMP is described in Part One, Annex A, Task 401.

4.2.2.3 Developing an Environmental Test and Evaluation Master Plan (ETEMP).

This plan is not a formal document, but is comprised of the products from three separate tasks (Tasks 402, 403, and 404). Early in the acquisition process, initial work on these tasks helps build materiel need and performance requirements documents by identifying basic environments in which the materiel will operate, and fundamental issues to be addressed during the remainder of the acquisition process. These three tasks contribute to the TEMP when they are completed. See Figure 1-1. The ETEMP contains basic guidance/background information not to be confused with detailed test planning documents explained in Task 405.

4.2.2.3.1 Defining a Life Cycle Environmental Profile (LCEP), Task 402.

The LCEP describes service-related events and environmental conditions that materiel will experience from its release from manufacturing to the end of its useful life. The scope and structure are shown on Figures 1-4a & b that serve as a generalized guide for developing LCEPs for acquisition programs. Tailor LCEPs to specific programs, treating each line in the body of Figures 1-4a & b as a survey or questionnaire item to see if it applies to the specific program for which the LCEP is being developed. It may be useful to develop a questionnaire based on this LCEP format, taking care to add unique, system-specific environmental stressors that may not appear on Figures 1-4a & b. Fundamental progress is required on this task early in the acquisition process to influence the CONOPS, SRD, ICD, CDD, CPD, SEMP, and TEMP. The completed LCEP is needed later in the process to help system designers and evaluators build the TEMP. Note that the LCEP does not specify design or test requirements. Rather, it serves as a tailored guide for deriving materiel designs and test parameters through Tasks 403 and 404, based on performance requirements.

4.2.2.3.2 Developing Operational Environment Documentation (OED), Task 403.

The OED task entails producing two documents. One is a plan for obtaining data that will serve as the basis for design and test criteria development. The other is a report that contains those plans and the resulting data. The plan, the Operational Environment Documentation Plan (OEDP), provides for two types of data. First, it contains plans for securing data that have been collected previously and are still valid for developing the materiel's design and test

MIL-STD-810H
PART ONE

criteria. Second, it contains plans for collecting data not available currently, describing how to obtain those environmental data under realistic operating or field conditions using actual or closely related systems/platforms. The OEDP and the resulting data (existing and new data) form the Operational Environment Documentation Report (OEDR).

4.2.2.3.3 Developing an Environmental Issues/Criteria List (EICL), Task 404.

The EICL is developed from the LCEP and OEDR. It contains a list of tailored issues and criterion, complete with appropriate criterion levels for the materiel being acquired. Also, it includes rationale and assumptions for how environmental effects issues and criteria were derived. This rationale aids designers, developers, and assessors as they revise criteria when materiel deployment concepts and designs change.

4.2.2.4 Preparing a Detailed Environmental Test Plan (DETP), Task 405.

Developers, evaluators, assessors, and testers prepare detailed environmental test and evaluation plans in various levels of detail (e.g., Independent Evaluation Plans through Detailed Test Plans), consulting with on-board EES as necessary. These detailed plans serve as the primary means for calling out specific laboratory and field tests, test sites, instrumentation, procedures, and criterion levels for environmental tests. The DETP may stand alone as an environmental test planning document or may appear as a subset of a larger test plan. Quite often, the highest level of detail in these plans appears in standard test procedures referenced in those plans. For environmental laboratory tests, detailed methods are in Part Two of this standard.

4.2.2.5 Preparing an Environmental Test Report (ETR), Task 406.

Environmental test reports are produced at various points in the acquisition process. Specifications for conducting development and operational tests, and formats for resulting reports are provided by development and operational test agencies. This task pertains mainly to the results of materiel tests performed in environmental testing laboratories. The ETR defines the test purpose, lists test issues/criteria, lists or describes test equipment/ facilities/instrumentation, explains the test design/set-up, contains detailed test data/logs, provides failure analyses, and interprets test results. The laboratory ETR is appropriate for design evaluation tests, operational worthiness tests, and qualification tests. Data from these laboratory tests serve as early warnings of unanticipated deviations from performance requirements. They support failure analyses and corrective actions related to the ability of materiel to withstand specific environmental conditions. These laboratory test data do not serve as substitutes for development or operational tests conducted in natural field/fleet environments.

4.3 Design and Test Engineers and Facility Operators.

4.3.1 Roles of Design Engineers.

Design engineers conduct engineering analyses that predict responses of materiel to the stresses of the environmental life cycle. These analyses are used to prepare materiel designs that incorporate necessary resistances to environmental stresses, to modify test criteria to account for factors that cannot be fully accounted for in laboratory testing, and to interpret test results during failure analyses and redesign.

4.3.2 Roles of Test Engineers/Facility Operators.

Test engineers develop test implementation plans/instructions that are carried out by other engineers or facility operators. Facility operators conduct tests according to direction established in system test planning and assessment documents and specific instructions prepared by test engineers/scientists who base their procedures on the environmental tailoring process. As a result of the tailoring process, laboratory testers will conduct only those tests that are appropriate, using exposure levels that will be neither too high nor too low because they will have been established according to the environments and levels that the materiel would be expected to see throughout its service life. In the same manner, field/fleet testers will conduct tests in those natural environments in which the materiel is expected to operate.

4.3.3 Guidance for Design and Test Engineers and Test Facility Operators.

4.3.3.1 Natural environment (field/fleet) testing.

Plan for and conduct natural environmental field/fleet tests, and incorporating the principles of environmental tailoring information into established field/fleet procedures and facilities.

4.3.3.2 Laboratory Testing.

Plan for and conduct laboratory tests according to the tailoring information above and specific guidelines below in Part One, plus specific guidelines in each Method of Part Two of this standard.

MIL-STD-810H
PART ONE

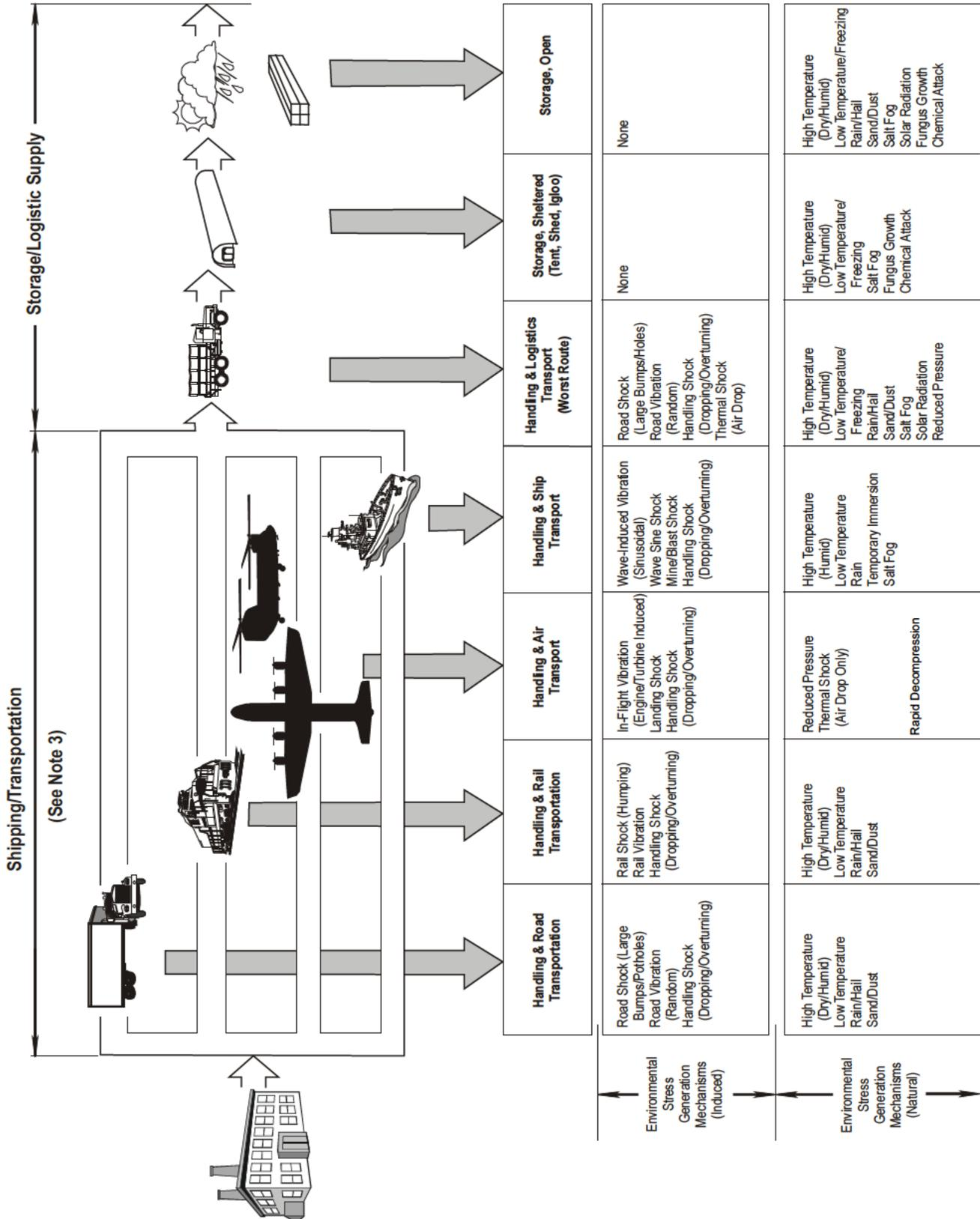


FIGURE 1-4a. Generalized life cycle histories for military hardware.

MIL-STD-810H
PART ONE

Note 1:
The environmental stress events experienced by actual hardware may not always occur in the sequence shown in this profile. The generalized profile is intended to be used as a starting point for a tailored life cycle stress analysis and to provide confidence that all potentially significant environmental conditions have been considered.

Note 2:
The generalized profile provides only representative decision-making information. It does not impose or imply a specific test order although it can aid in suggesting potentially useful environmental test stress combinations or sequences.

Note 3:
Hardware may be subjected to any or all of the shipping/transportation modes shown. Therefore, in any life cycle stress analysis, the anticipated stresses experienced by the hardware in each mode should be evaluated and the most significant of these incorporated in the test program.

Note 4:
The generalized profile shows only areas of environmental concern and does not attempt to show operational use patterns. The relative frequency and duration of storage, shipping, and mission events must be considered in determining life cycle environmental test parameters. It should also be remembered that even one-shot devices (rockets, shells, etc.) must endure combinations and repetitions of all these events before they are ultimately fired.

Note 5:
In the interest of completeness, some environmental stress generating mechanisms have been included for which corresponding tests are not included in this document. Their absence from this document does not imply a lack of importance; they should be given equal consideration in the life cycle stress analysis.

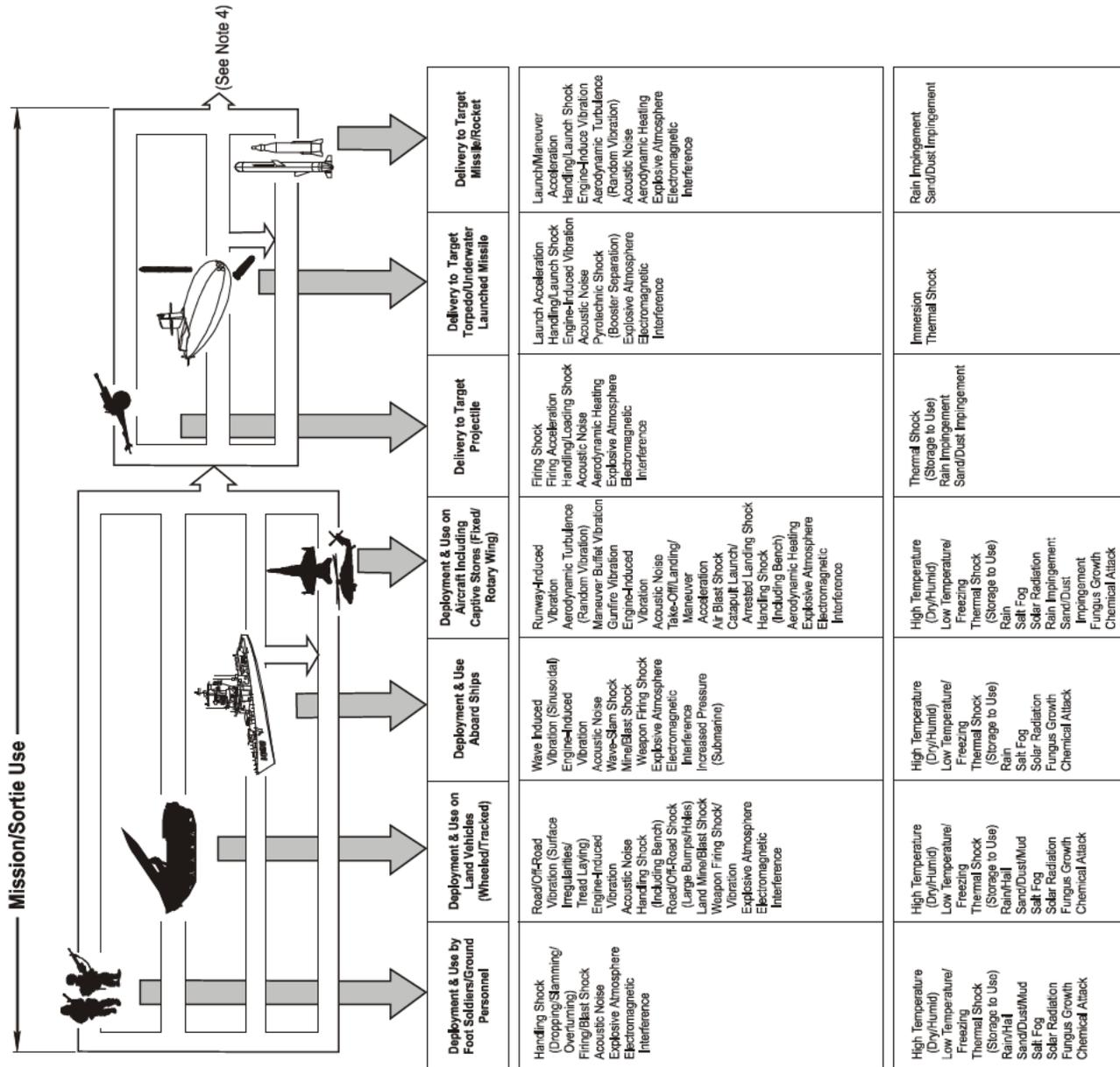


FIGURE 1-4b. Generalized life cycle histories for military hardware.

MIL-STD-810H
PART ONE

5. GENERAL LABORATORY TEST METHOD GUIDELINES.

NOTE: Safety is an inherent concern in all test programs. Specific concerns are addressed in appropriate test methods. Guidelines for establishing a materiel safety program are in MIL-STD-882.

5.1 Test Conditions.

a. Standard Ambient.

When the term "standard ambient" is specified in the Methods of this standard, use the values shown below. If the term is not used and no specific values are called for in the test Method or the materiel specification, conduct item tests (e.g., pre-, during, and post-test) at standard ambient conditions.

Temperature:	25° ± 10°C (77 ± 18°F)
Relative humidity:	20 to 80 percent
Atmospheric pressure:	Site pressure

b. Controlled ambient.

When the ambient conditions must be closely controlled, maintain the following:

Temperature:	23° ± 2°C (73 ± 3.6°F)
Relative humidity:	50 percent ± 5 percent
Atmospheric pressure:	96.45 +6.6 / -10.0 kPa 28.5 +2.0 / -3.0 in Hg

c. Input power.

If the test item requires electrical input power to function, one should consider the normal operational input voltage range (steady state) specified from the power source (generator, transformer rectifier, and alternator/battery) that would be encountered in use. On military aircraft and ground vehicles, these voltage ranges can be found in MIL-STD-704A-F and MIL-STD-1275A-D. On military shipboard mounted equipment, the voltage ranges can be found in MIL-STD-1399, section 300. Commercial aircraft ranges can normally be found in RTCA DO-160, section 16, power input. Commercial ground equipment input power is normally obtained from building utilities. Identify and use commercial standard voltage ranges for these test items. Use of other applicable documents may be required as needed. In addition to nominal voltage, operation at the upper and lower thresholds should be considered. Electrical and power characteristics for aircraft and ground vehicles can be found in Method 520, however it is highly recommended these values are cross referenced with the aforementioned Military Standards to ensure the most current values are utilized.

An electrical survey may be required if there is a potential voltage, frequency, crest factor, ripple, phase displacement, or distortion issue that could lead to test item failure and/or safety of personnel.

NOTE: Every effort has been made to use metric units throughout this document. The initial figures are followed by US units in parentheses, but these conversions are not usually repeated throughout this document.

5.2 Tolerances for Test Conditions.

Unless otherwise specified in the individual test methods, adhere to the test condition tolerances shown below for the following parameters. Any tolerance shown as ± X following a specified value is intended to mean the specified value is what is intended but, because of instrumentation or measurement inaccuracies, a slight deviation is acceptable but not outside of the tolerance. The accuracy and calibration requirements for instrumentation and test equipment used for control or monitoring are typically specified in the referenced test methods. Where such requirements are not specified in the referenced test methods, the accuracy shall be equal to at least 1/3 of the tolerance of the variable being measured.

Recommended default tolerances for common test parameters are provided below. Where there is conflict between these recommended values and any requirements stated in the referenced test methods, the requirements of the referenced methods take precedence.

MIL-STD-810H
PART ONE

All instrumentation and test equipment shall be calibrated periodically to laboratory standards whose calibration is traceable to national laboratory standards. The test facility shall maintain the calibration records.

- a. Test section air temperature. Surround the test item totally by an envelope of air (except at necessary support points), considering boundary effects. Keep the air temperature uniform in the immediate vicinity of the item. To ensure the test item is bathed in the required air temperature, place verification sensors at representative points around the entire item and as close to the test item as possible, but not so the airstream temperature is affected by the test item temperature. Keep these temperatures within $\pm 2^{\circ}\text{C}$ (3.6°F) of the required test temperature. Ensure the air temperature gradient across the item does not exceed 1°C (2°F) per meter or a maximum of 2.2°C (4°F) total (test item non-operating). Wider temperature tolerances are acceptable in situations such as:
 - (1) For large items with a volume greater than 5m^3 (6.5yd^3), the temperature tolerance can be $\pm 3^{\circ}\text{C}$ ($\pm 5^{\circ}\text{F}$). Justify any larger tolerance and obtain approval for its use from the procuring activity.
 - (2) For required temperatures greater than 100°C (212°F), the temperature tolerance can be $\pm 5^{\circ}\text{C}$ ($\pm 9^{\circ}\text{F}$). Specify the actual tolerance achieved.
- b. Pressure. ± 5 percent of the value or $\pm 200\text{ Pa}$ (0.029 psi), whichever is greater.
- c. Humidity. Keep relative humidity at the chamber control sensor to ± 5 percent RH of the specified value.
- d. Vibration amplitude. See the tolerances specified in the test methods.
- e. Vibration frequency. See the tolerances specified in the test methods.
- f. Acceleration. See the tolerances specified in the test methods.
- g. Time. Control time (e.g., test durations and data gathering intervals) for climatic testing is within ± 5 minutes for a total test duration greater than 8 hours, and within ± 1 percent of the specified value for durations or intervals of 8 hours or less, unless the nature of the test requires greater accuracy.
- h. Air velocity. Maintain within ± 10 percent of specified value.
- i. Water purity. See paragraph 5.16.
- j. Input Power. When input power is of major concern, use tolerances listed in the applicable power source standards (i.e., voltage, frequency, crest factor, ripple, phase displacement, distortion) referenced in Part One, paragraph 5.1.

5.3 Test Instrumentation.

5.3.1 Suitability for Environment.

Ensure the sensors and instrumentation to be used for recording environmental conditions and responses are suitable for the intended environments. For example, accelerometers used in a combined high temperature/vibration test could give erroneous readings if not designed for high temperature use.

5.3.2 Calibration.

Prior to and following each test, verify the accuracy of instruments and test equipment used to control or monitor the test parameters. Calibration intervals must meet the guidelines of ANS/ISO/IEC 17025:2005, ANSI/NCSL Z540.3-2007 or ISO 10012 to the satisfaction of the procuring activity. All instruments and test equipment used in conducting the tests in this document should:

- a. Be calibrated to laboratory standards, traceable to the National Standards via primary standards.
- b. Have an accuracy at least equal to $1/3$ the tolerance of the variable to be measured. In the event of conflict between this accuracy and guidelines for accuracy in any one of the test methods of this standard, the latter governs.

5.4 Stabilizing Test Temperature.

Temperature stabilization is generally important to ensure reproducible test conditions. Stabilizing test item elements critical for operational requirement (i.e., components, sub-assemblies, etc.) is normally more important than stabilizing temperatures of structural members. The following information is based on this intent.

MIL-STD-810H
PART ONE

5.4.1 Test Item Operating.

Unless otherwise specified, operating temperature stabilization is attained when the temperature of the functioning part(s) of the test item considered to have the longest thermal lag is changing at a rate of no more than 2.0°C (3.6°F) per hour.

5.4.2 Test Item Non-Operating.

Unless otherwise specified, non-operating temperature stabilization is attained when the temperature of the functional part(s) of the test item considered to have the longest thermal lag reaches a temperature that is within the temperature tolerance of the air surrounding the test item. Structural or passive members are not normally considered for stabilization purposes. When adjusting temperatures, the temperature of the chamber air may be adjusted beyond the test condition limits to reduce stabilization time, provided the extended temperature does not induce a response temperature beyond the test item's temperature limits.

5.5 Test Sequence.

Base the specific sequence on the item, its intended situation-dependent use, available program assets, and anticipated synergetic effects of the individual test environments. In defining a life cycle sequence of exposures, consider recurring exposure(s) that might reasonably occur during service use. In most cases there is no single defined sequence. See Annex C of Part One for additional information.

- a. Use the anticipated life cycle sequence of events as a general sequence guide. However, experience has shown definite advantages to performing certain tests immediately before, in combination with, or immediately following other tests. Where these advantages have been identified in the information in the test methods, follow the test sequence. Use other sequences and combinations consistent with good tailoring practices with the permission of the acquisition agency. With the exception of information provided in the individual methods, do not alter test sequences to ease the effects of the tests.
- b. Relate cumulative effects on performance and durability of a materiel item to a test sequence that stresses materiel in the proper order according to its mission profile (see Part One, Figures 1-4a & b as an example). Developing such a test sequence requires communication among the test sponsor, the tester, the evaluator, and the end user early and often to ensure a trackable, reliable, and realistic test effort.

5.6 Test Level Derivation.

Derive specific test levels, ranges, rates, and durations from data that occur on identical or appropriately similar materiel that is situated on platforms under similar natural environmental conditions (see Annex A, Task 403, 403.2.1). When data from actual situations are not available or cannot be obtained nor estimated easily, tailor the test characteristics using the information found in specific methods.

5.7 Pretest Information for Facility Operators.

Provide the following (in addition to any information required in the individual test methods):

- a. Test facilities and instrumentation.
- b. Required test procedure(s).
- c. Critical components, if applicable.
- d. Test duration.
- e. Test item configuration.
- f. Test level and method of stress application.
- g. Location of instrumentation/sensors, e.g., thermocouples, transducers.
- h. Test item installation details (including mounting provisions, orientation, interconnections, etc.).
- i. Cooling provisions, if appropriate.

5.8 Test Setup.

5.8.1 Installing the Test Item in Test Facility.

Unless otherwise specified, install the test item in the test facility in a manner that will simulate service use to the maximum extent practical, with test connections made and instrumentation attached as necessary.

- a. To test the effectiveness of protective devices, ensure plugs, covers, and inspection plates used in servicing are in whatever position is appropriate for the test and in their normal (protected or unprotected) mode during operation.

MIL-STD-810H
PART ONE

- b. Make electrical and mechanical connections normally used in service, but not required for the test being performed (e.g., tests of items not running) with dummy connectors installed (connected and protected as in field/fleet use) so that all portions of the test item will receive a realistic test.
- c. If the item to be tested consists of several individual units, these units may be tested separately, provided the functional aspects are maintained as defined in the requirement's document. If units are being tested together and the mechanical, electrical, and radio frequency (RF) interfaces permit, position units at least 15cm (6 inches) from each other or from the test chamber surfaces to allow for realistic air circulation.
- d. Protect test items from unrelated environmental contaminants.

5.8.2 Test Item Operation.

Operate the test item in the most representative operating modes (from performance and thermal standpoints) using duty cycles and durations that represent service use as documented in the mission profile. Operational testing should be considered during each of the test Methods within this standard. Prior to conducting operational testing, a sequence of events, number of cycles, and duration of events should be documented in the test plan. In addition to the items noted in Part One, paragraph 5.1c, abnormal or emergency voltage ranges should be considered for equipment required for safety of personnel.

5.9 Pretest Baseline Data.

Before environmental exposure, operate the test item under standard ambient conditions (see 5.1) to ensure the test item is operating properly and to obtain baseline performance data. Include the following information in the pretest documentation:

- a. Background data of each item:
 - (1) Item nomenclature, model, serial number, manufacturer, etc.
 - (2) General appearance/condition.
 - (3) Specific physical anomalies.
 - (4) Environmental test history of the specific item.
- b. Collect pretest data on the functional parameters that will be monitored during and after each environmental test. Use functional parameters and operational limits specified in the materiel specification or requirements document. If such specifications are not provided, establish and apply appropriate parameters/limits for the pretest, the main test, and the post test.
- c. Photographs of the test item as necessary to evaluate post test results.

5.10 Information During Test (for inclusion in the Test Report).

- a. Performance check. Monitoring and recording of test item's critical performance parameters is required before and after all tests (pre and post test). Monitoring of performance parameters is not required during non-operational tests such as storage and transportation. Monitoring and recording of the critical performance parameters during operational tests is required. If unable to monitor during operational tests, obtain test sponsor approval prior to the start of testing and document rationale in the test report.
- b. Test facility. Maintain a record of environmental conditions applied to the test item.
- c. Test item response. Maintain a record of test item response to applied environmental forcing functions.
- d. Test interruptions. See guidance with respect to specific test methods.

5.11 Interrupted Tests.

For the purpose of standardization and valid testing, and unless otherwise specified in the individual methods, apply the following procedures when a test is interrupted. Explain test interruptions in the test report, and any deviation from the following information. Due to the nature of testing, any observation that may indicate a safety issue should be immediately addressed.

5.11.1 In-Tolerance Interruptions.

Interruption periods during which the prescribed test conditions remain in tolerance (e.g., power interruptions that do not affect chamber temperature) do not constitute a test interruption. Therefore, do not modify the test duration if exposure to proper test levels was maintained during the ancillary interruption.

5.11.2 Out-of-Tolerance Interruptions.

A logic diagram for these methods is on Figure 1-5.

MIL-STD-810H
PART ONE

- a. **Undertest.** If test condition tolerances fall below the minimum tolerance value (i.e., environmental stress less severe than specified) resulting in an undertest condition, the test may be resumed (after reestablishing prescribed conditions, except as noted in the individual methods) from the point at which the test condition fell below the lower tolerance level. Extend the test to achieve the prescribed test cycle duration.
- b. **Overtest.** If an overtest condition occurs, the preferable course of action is to stop the test and start over with a new test item. If it can be shown that the overtest condition had no detectable effect on the test item, continue the test. Overtest conditions can damage the test item and cause subsequent failures that may not have occurred otherwise, thus failing a test item because of an invalid test. However, if damage resulting directly from an overtest occurs to a test item component that has absolutely no impact on the data being collected, and it is known that such damage is the only damage caused by the overtest (e.g., rubber feet on bottom of a test item melted by high temperature where those feet have no impact on the performance of the test item), the test item can be repaired and the test resumed and extended as in the undertest condition. Coordinate with the customer before repairing and continuing to test an item after it has been overtested. This coordination is aimed at preventing customer objections if the test item fails during the remainder of the test program (claims that the test was invalid past the point of the overtest because the overtest caused undiscovered damage to a critical component).

5.11.3 Interruption Due to Test Item Operation Failure.

Each Method contains information for handling interruptions due to test item failure. Analyze any such interruption carefully. The failure of the item may be due to accumulative stress of several tests in sequence and not just the final test where the item failed.

5.11.4 Scheduled Interruptions.

It is highly recommended to perform a continuous test(s) without interruptions, however there may be situations in which test interruptions are necessary. This may be to conduct maintenance to the test item or perform an inspection. Such interruptions must be scheduled prior to the start of test so as to minimize the disruption to the test. These interruptions cannot be allowed to affect the result of the test. Additionally, they should not be so frequent that the test conditions cannot stabilize between interruptions. All scheduled interruptions should be documented in the test plan prior to the start of testing. The rationale for any deviation or unscheduled interruption shall be documented as they occur and included in the test report.

5.12 Combined Tests.

Combinations of tests may represent the effects of the environment more realistically than a series of single tests. Combined environment testing is encouraged when these conditions may be expected in operational environments.

5.13 Post-Test Data.

After completing each environmental test, examine the test item in accordance with the materiel specifications. Operate the test item when appropriate for obtaining post-test data. Compare the results with the pretest data obtained in accordance with paragraph 5.9. Include the following information in the post test record and report:

- a. Test item identification (manufacturer, model/serial number, etc.).
- b. Test equipment identification, including accessories.
- c. The actual test sequence (program) used.
- d. Deviation from the planned test program (including explanation and rationale).
- e. Performance data collected on the same parameters at the same operational levels as those of the pretest (including visual examination results and photographs, if applicable).
- f. Room ambient test conditions recorded periodically during test period.
- g. Other data specified in individual methods or requirements document(s).
- h. Initial failure analyses, if applicable.
- i. A signature and date block for the test engineer/technician to certify the test data.

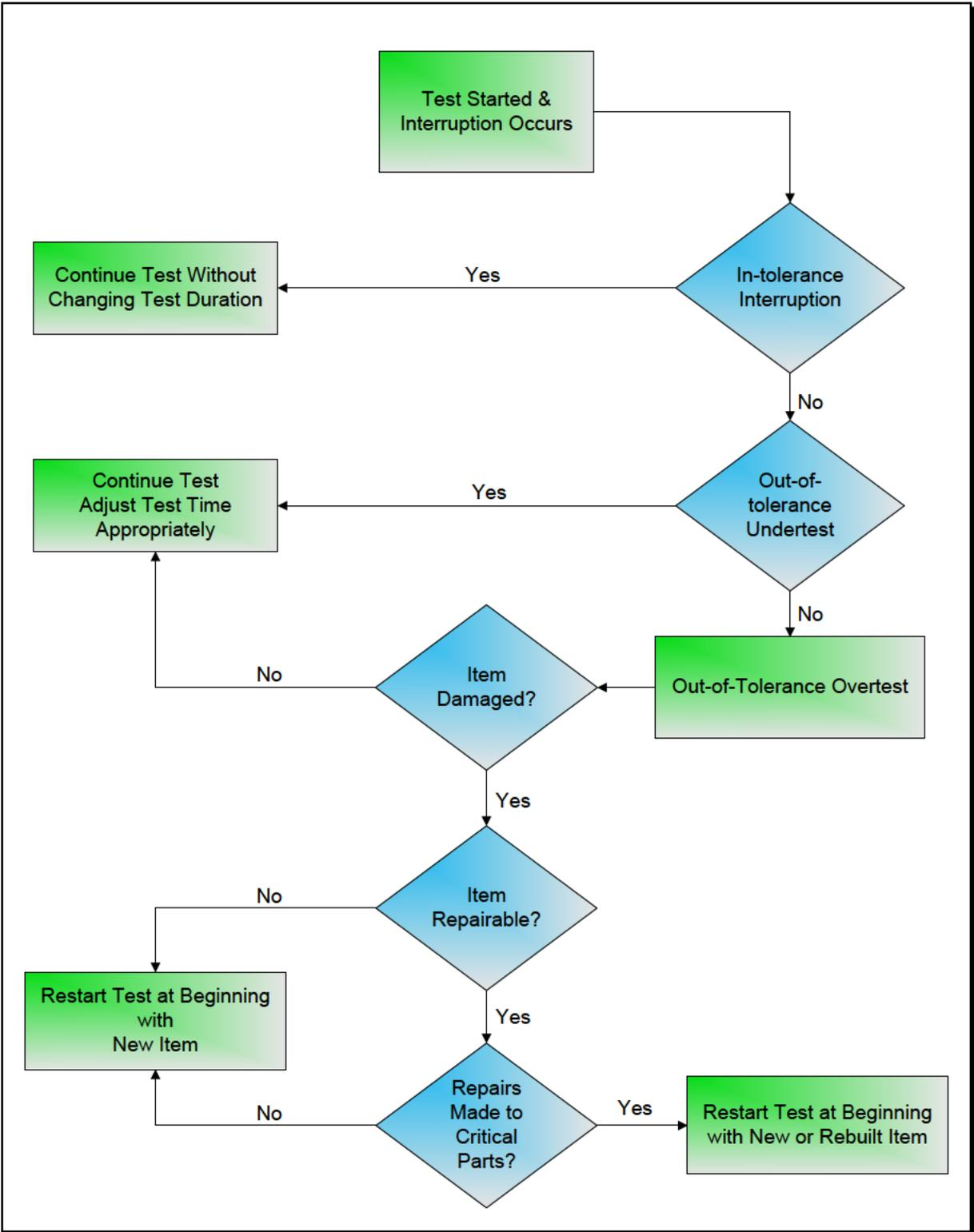
MIL-STD-810H
PART ONE

Figure 1-5. Interrupted test cycle logic.

Note: Regardless of the type of interruption, a safety evaluation should be conducted on the test item and facilities/test equipment prior to restart of testing.

MIL-STD-810H
PART ONE

5.14 Environmental Effects and Failure Criteria. (See also paragraph 5.17, below.)

Interpretation of the effects of an environmental test depends on the purpose of the test in the context of a specific acquisition program. Structural degradation and performance anomalies may be considered as useful information during engineering development tests, but as failures during formal tests for contractual compliance. The following are some of the most common conditions that could constitute a materiel failure, depending on specific contract requirements.

- a. Deviation of monitored functional parameter levels beyond acceptable limits established in the pretest performance record and specified in the requirements document. **NOTE:** Certain types of materiel (e.g., propellants and electrically driven devices) often are expected to demonstrate decreased performance at an environmental extreme, particularly low temperature. A failure would occur only if degradation is more than permissible, or remains degraded after removal of the environmental stress.
- b. Not fulfilling safety requirements or developing safety hazards.
- c. Not fulfilling specific materiel requirements.
- d. Test item changes that could prevent the materiel from meeting its intended service life or maintenance requirements. (For example: Corroded oil drain plug cannot be removed with specified tools.)
- e. Deviation from established environmental impact requirements. (For example: Exhaust emission levels beyond established limits or seal failures that allow oil spills.)
- f. Additional failure criteria as specified in the materiel specification.

5.15 Environmental Test Reports

Complete environmental test reports according to Part One, Annex A, Task 406.

5.16 Water Purity.

It is essential that water used for humidity (water vapor and wet bulb socks), salt fog, and fungus growth (all aspects) tests not unfairly impose contaminants or unintended products on test items, or affect fungus germination. Chemicals commonly found in commercial water supplies such as chlorine can cause unintended corrosive effects. Solubles such as calcium carbonate (lime) or insolubles can cause nozzles to clog or leave deposits. Water with a non-neutral pH could cause unintended effects on materiel. Accordingly, rather than impose unrealistic water purity requirements on test establishments, recommend water used for these tests be relatively clean of impurities and chemicals, and have a pH in the range of 6.5 to 7.2 at 25°C (77°F) at the time of the test.

NOTE: A water resistivity in the range of 0.15 megohm cm to 5 megohm cm is recommended, but document any water used that is outside this range. This can be produced using distillation, demineralization, reverse osmosis, or deionization.

5.17 Analysis of Results.

- a. The analysis of test results is to be consistent with the guidance provided in paragraph 5.14, above, as well as Part One, Annex A, Tasks 405 and 406. Additionally, the analysis of results will, in general, consist of presentation in some appropriate format as called out by the DETP, the (1) measured input environment to the test item; (2) the measured response environment of the test item, and (3) the functional or operational performance of the test item under the environmental stress. With regard to (1) and (2), these may include temperature, humidity, pressure, acoustic noise, acceleration, velocity, displacement, vibration, or shock. With regard to (3), this may include the mechanical, electrical, overall functional or safety performance while under environmental stress.
- b. The goal of the “analysis of results” paragraph in each test Method is an attempt to correlate the measured response environments and the functional or operational performance of the test item with the measured input environment considering any synergistic effects. Performance of this correlation may require an understanding of an idealized model of the test item, a careful study of the physics of failure, and some rudimentary understanding of the synergistic effects of combined environments. In extended duration environmental tests, an understanding of the general “fatigue” stress receptivity of the test item is required. Underlying all of this is the purpose of the test and the relationship of the test to the goals of the test, i.e., environmental qualification, test-analyze-and-fix, developmental testing, etc. In some cases the test will be designed to simulate the in-service environment. In other cases it will be designed to envelope the environment in hope of providing a conservative margin to a design and, in other cases, the test may be exploratory in nature to examine the “fragility” of the test materiel.

MIL-STD-810H
PART ONE**5.18 Monitoring.****5.18.1 Monitoring Test Chamber Parameters.**

It is good scientific and engineering practice to monitor chamber conditions to ensure the chamber settings are correct, and the desired environmental conditions within the chamber are being maintained within specified tolerances throughout the duration of the test. An environmental engineering specialist should work with the customer to tailor monitoring requirements to the customer's needs. Considerations include:

- a. The frequency of monitoring may vary depending on the data requirements and how the data are to be used. Monitor test parameter levels throughout the test at intervals that are meaningful for the item under test such that a failure to maintain prescribed parameter levels may be corrected without jeopardizing the validity of the test.
- b. Establish an alarm system to be triggered by parameter levels that stray out of tolerance beyond acceptable limits.
- c. To provide proof of parameter level maintenance, keep a manually- or electronically-produced log of parameter levels. Exact parameter monitoring intervals and exact methods of recording parameter levels may vary for different methods and for different items being tested using a specific method. In some instances, monitoring chamber parameters may be required only at long intervals (15-minutes or even several hours). In others, continual, non-stop recording may be necessary.
- d. The technology involved in recording parameter levels may involve visual checks at prescribed intervals, real time continuous recording such as a circular chart, periodic recording on a device such as a data logger, or other techniques established in a contract or agreed upon by the tester and the customer.
- e. From a quality assurance standpoint, the intervals at which monitoring should occur depend on how meaningful the interval length is to the customer, who should be provided with monitoring records that are no longer, or shorter in interval than the customer's needs.

5.18.2 Monitoring the Item Under Test.

It is equally important to monitor the test item itself to record the effects of the chamber environment on the physical condition or performance of the item under test. The reason for such monitoring is to ensure that pertinent changes in the condition of the item under test are captured at relevant intervals throughout the duration of the test so that meaningful test item failure analyses may be performed. Consider the following:

- a. The tester must meet contractual or other monitoring requirements established by the customer to fulfill test data needs.
- b. The frequency of monitoring will vary depending on the data requirements and how the data are to be used. For example, during conditioning, it may be desirable to monitor the condition of the test item infrequently because the information gathered during this period of testing, though important, may not be highly critical. However, during cycled static testing or system performance testing, the frequency of monitoring the test item may be higher at the beginning of a test to capture initial, fast-occurring degradation. Other minimum intervals may be set to capture transient events that may occur at any time during the test.

NOTE: If the test item is intended to be occupied during test events, consideration should be given to installation of sensors to monitor health hazards such as VOCs, CO, and Phthalates due to potential off-gassing/out-gassing.
--

5.19 Total High Temperature Exposure Duration.

The total materiel temperature conditioning exposure duration time for the test program should be less than the life expectancy time of any component material. Determine the total exposure time from the sum of the pre-conditioning time, plus any standby time, plus actual laboratory testing time. A total exposure duration greater than the materiel life limit can create an accelerated material failure mode or materiel degradation that is unrelated to the simulated environmental test condition. In particular, use caution during testing of energetic or chemically-reactive materials that degrade under elevated temperature conditions. To determine the total exposure time, the test program engineer must consider each phase of environmental testing, mechanical climatic and electrical, and any additional standby time prior to final operational or performance tests. Standby or pre-conditioning time, such as maintaining the item at conditioned temperature over a weekend, can have a significant impact. The actual test conditions of concern are the duration for high temperature storage and operational tests, high temperature soaks during vibration, and possibly solar radiation tests.

MIL-STD-810H
PART ONE

5.20 Temperature Change Rate.

Unless otherwise specified, control the rate of temperature change to not exceed 3 °C (5 °F) per minute to prevent thermal shock. For simulation of thermal shock conditions, the temperature change rate should be greater than 10°C (18°F) per minute.

6. NOTES.

(This paragraph contains information of a general or explanatory nature that may be helpful, but is not mandatory.)

6.1 Intended Use.

This Standard is intended to organize and standardize the approach within the materiel acquisition process for considering how environmental stresses affect materiel design, test, and evaluation of materiel developed to perform combat and support missions in environments unique to military operational environments. It emphasizes developing materiel to withstand the stresses it is intended to see during its life cycle, and testing such materiel accordingly. The intended result is to eliminate over- and under-designed/tested materiel with respect to environmental stresses; to ensure environmental considerations are addressed systematically; to ensure test plans are tailored realistically as well as thoroughly; to ensure test execution adheres to tailored test plans, and to ensure test reports are complete and meaningful.

6.2 Acquisition Requirements.

- a. Acquisition documents should specify the title, number, and date of this Standard.
- b. Unless the DOD FAR supplement 27.475.1 exempts the requirements for a DD Form 1423 (Contract Data Requirements List), Method 528.1 has been assigned an Acquisition Management Systems Control (AMSC) number authorizing it as the source document for the following DIDs that must be listed.

DID Number	DID Title
DI-ENVR-81647	Mechanical Vibrations of Shipboard Equipment Measurement Test Plan and Report
DI-MISC-81624	Notification of Test/Trials

6.3 Subject Term (Key Word) Listing.

Acceleration
Acidic Atmosphere
Acoustic Noise
Climatic Environment
Dust
Environmental Life Cycle
Environmental Test Procedures
Explosive Atmosphere
Fluid Contamination
Freeze / Thaw
Fungus
Gunfire Shock
Humidity
Icing
Immersion
Low Pressure (Altitude)
Mechanical Vibration of Shipboard Equipment
Multi-Exciter Testing
Natural Environment
Pyroshock
Rain
Rail Impact
Salt Fog
Sand
Shock

MIL-STD-810H
PART ONE

Solar Radiation
Temperature
Time Waveform Replication
Vibration
Vibro-Acoustic

6.4 International Standardization Agreement Implementation.

This standard implements STANAG 4370, Environmental Testing and the respective AECTPs. When changes to, revision, or cancellation of this Standard are proposed, the preparing activity must coordinate the action with the US National Point of Contact for the international standardization agreement, as identified in the ASSIST database at <https://assist.dla.mil>.

6.5 Changes from Previous Issue.

The margins of this Standard are marked with vertical lines to indicate where changes from the previous issue are made. This was done as a convenience only, and the Government assumes no liability whatsoever for any inaccuracies in these notations. Bidders and contractors are cautioned to evaluate the requirements of this document based on the entire content irrespective of the marginal notations and relationship to the last previous issue.

MIL-STD-810H
PART ONE

(This page is intentionally blank.)

MIL-STD-810H
PART ONE ANNEX A

PART ONE, ANNEX A
ENVIRONMENTAL MANAGEMENT AND ENGINEERING TASKS

<u>Task</u>	<u>Page</u>
Task 401 - Environmental Engineering Management Plan (EEMP)	A-2
Task 402 - Life Cycle Environmental Profile (LCEP)	A-3
Task 403 - Operational Environment Documentation (OED).....	A-15
Task 404 - Environmental Issues/Criteria List (EICL).....	A-17
Task 405 - Detailed Environmental Test Plans (DETP).....	A-18
Task 406 - Environmental Test Report (ETR).....	A-21

MIL-STD-810H
PART ONE ANNEX A**TASK 401****ENVIRONMENTAL ENGINEERING MANAGEMENT PLAN (EEMP)**401.1 Purpose.

The EEMP is basically an administrative document prepared by the Program Manager's staff or contract personnel responsible to the Program Manager. It provides a schedule for integrating Tasks 402 through 406 into the System Engineering Management Plan (SEMP). By so doing, the EEMP lays out a viable and cost effective environmental effects program to help ensure that materiel will be designed and tested for all pertinent environmental conditions to which it will be subjected during its life cycle. The EEMP also outlines critical environmental engineering technical and communications interfaces between the materiel developer and the procuring agency.

401.2 Task description.

As a minimum, perform the following subtasks and include subtask products in the EEMP:

- a. Identify Government agencies and contracts that will include EES personnel to assist in organizing and executing environmental engineering tasks. Include list in EEMP.
- b. Include in the EEMP the environmental engineering tasks listed below. Note that Tasks 402, 403, and 404 comprise the Environmental Test and Evaluation Master Plan (ETEMP) that provides fundamental input to the ICD and CDD and detailed input to the TEMP (see Part One, Figure 1-1, and 4.1.2.4).
 - (1) Task 402 - Life Cycle Environmental Profile (LCEP)
 - (2) Task 403 - Operational Environment Documentation (OED)
 - (3) Task 404 - Environmental Issues/Criteria List (EICL)
 - (4) Task 405 - Detailed Environmental Test Plans (DETP)
 - (5) Task 406 - Environmental Test Report (ETR)
 - (6) Other program-specific tasks as appropriate
- c. Provide risk assessments for any tasks that are eliminated or curtailed, and for alternatives to testing actual hardware or prototypes. For example, if using an analytical procedure, acceptance by similarity to another system, coupon samples or simulations is used in lieu of testing actual systems or prototypes, explain the cost savings, other benefits, and risks to system effectiveness/safety. Because the EEMP is a living document, it may be changed at any time to accommodate such alternatives.
- d. Develop schedules, milestones, and personnel requirements needed to accomplish these tasks.
- e. Identify lines of communication among the specific developer and acquisition agency organizational elements responsible for environmental engineering.
- f. Develop methods/schedules for monitoring, assessing, reporting government and contractor progress on tasks; updating task products (e.g., profiles and plans), and for implementing corrective actions for problems in developing and executing the EEMP, and include them in EEMP.

401.3 Details to be provided by the acquisition agency.

- a. Complete description of the materiel to be developed and the scenarios associated with its intended service application(s).
- b. Schedule and procedures for EEMP submittal.
- c. Identification as a contract task or submittal.
- d. Special conditions or restrictions.

MIL-STD-810H
PART ONE ANNEX A**TASK 402****LIFE CYCLE ENVIRONMENTAL PROFILE (LCEP)**

402.1 Purpose. The LCEP is to be prepared no later than the early part of the Technology Development phase and will aid in the development of the CONOPS, SRD, ICD, CDD, and the CPD. The LCEP, prepared by an environmental engineering specialist (combat/materiel developer staff or contractor), identifies and characterizes environments or combinations of environments to which the materiel could be exposed throughout its service life. Use the LCEP as the baseline document to support design and test activities throughout the materiel development process.

402.2 Task description. This is one of three tasks (Task 402, 403, and 404) that make up the Environmental Test and Evaluation Master Plan (ETEMP). The LCEP accurately describes real-world environmental conditions that are relevant to the materiel being developed. It provides a consistent baseline for design and test decisions regarding materiel performance and survival under realistically outlined operational environmental conditions. As such, it should not contain conservatism factors, parameter exaggeration, or test procedures that will be covered by other tasks. The LCEP is a living document that should be reviewed and updated periodically as new information regarding operational environmental conditions becomes available. A comparable NATO document, Allied Ordnance Publication 15 (AOP-15), "Guidance on the Assessment of Safety and Suitability for Service of Non-Nuclear Munitions for NATO Armed Forces" (1998), provides methodology to define specific details of the service environments, and to identify appropriate testing to demonstrate that munitions will perform acceptably under those conditions.

402.2.1 Contents of an LCEP. As a minimum, perform the following subtasks and include subtask products in the LCEP:

- a. Describe the anticipated logistical and operational events associated with the materiel from the time of final factory acceptance until the end of its useful life. Include description in the LCEP.
- b. Develop a list of significant natural and induced environments or combinations of environments associated with each of the events described in "a" above, and include the list in the LCEP.
- c. Prepare narrative, tabular, graphic, and statistical characterizations, to the extent practical, of the environmental stress conditions identified in "b" above. These characterizations may be a combination of analytical calculations, test results, and measurements on materiel systems in service. Include characterizations in LCEP.

402.2.2 Special considerations. When appropriate in developing the LCEP, describe the following special considerations along with any others that may apply, and include their descriptions in the LCEP:

- a. Anticipated materiel configuration (s) during manufacturing, handling, repair/rework, environmental stress screening (ESS), and transport.
- b. Environments to be encountered and their associated geographical and physical locations.
- c. Packaging/container designs/configurations.
- d. Platform on which the materiel is mounted, stored, or transported.
- e. Structural, operating, and other interfaces with adjacent materiel.
- f. Absolute and relative durations of exposure to environmental conditions in each life cycle phase, as well as any other circumstances of occurrence.
- g. Number of times each life cycle phase is expected to occur and its frequency or likelihood of occurrence.
- h. Anticipated limitations and critical values that the environment may have on the materiel because of materiel design or natural laws (e.g., fog or other precipitation may inhibit the effectiveness of infrared sensors).

402.3 Details to be provided by the acquisition agency. The LCEP must be the product of the shared knowledge of both the materiel supplier and the acquisition agency. The acquisition agency must provide, as a minimum:

- a. A thorough description of all anticipated logistical and operational events associated with the materiel from the time of final factory acceptance until its terminal expenditure, removal from the inventory, and demilitarization. Include:
 - (1) Geographical areas of service or deployment.
 - (2) Platforms on which the materiel will be mounted, stored, or transported.
 - (3) Actual measurements of environmental conditions related to the same or similar materiel and platforms.

MIL-STD-810H
PART ONE ANNEX A

(4) Concept of Operation (CONOPS)

- b. Schedule and procedures for LCEP submittal.
- c. Identification as a contract task or submittal.
- d. Special conditions or restrictions.

402.4 Life Cycle Environmental Profile Questionnaire. To aid in the development of the CONOPS, SRD, ICD, CDD, and the CPD, the following questionnaire may be used to identify the planned environments and possible induced external influences during the in-service life of the materiel. The questionnaire is divided into eight sections, two main tables and six supplemental tables. Section 1 provides basic information about the materiel and should be used to identify the general purpose of the materiel. The response to the directions in sections 2 through 7 will be dependent upon the way the materiel will be stored, transported or serviced. This response can be filled out in Tables A and B. Some of the information in these tables will require more detailed information which can be filled out in tables C through H. The final question in section 8 is applicable any time. In the following questions, information should be provided if there is even a minimal chance of exposure to the respective environment. Annex C, Table C-II through C-IV contains a detailed list of environmental forcing functions an item may encounter throughout its storage, transportation, and deployment phase.

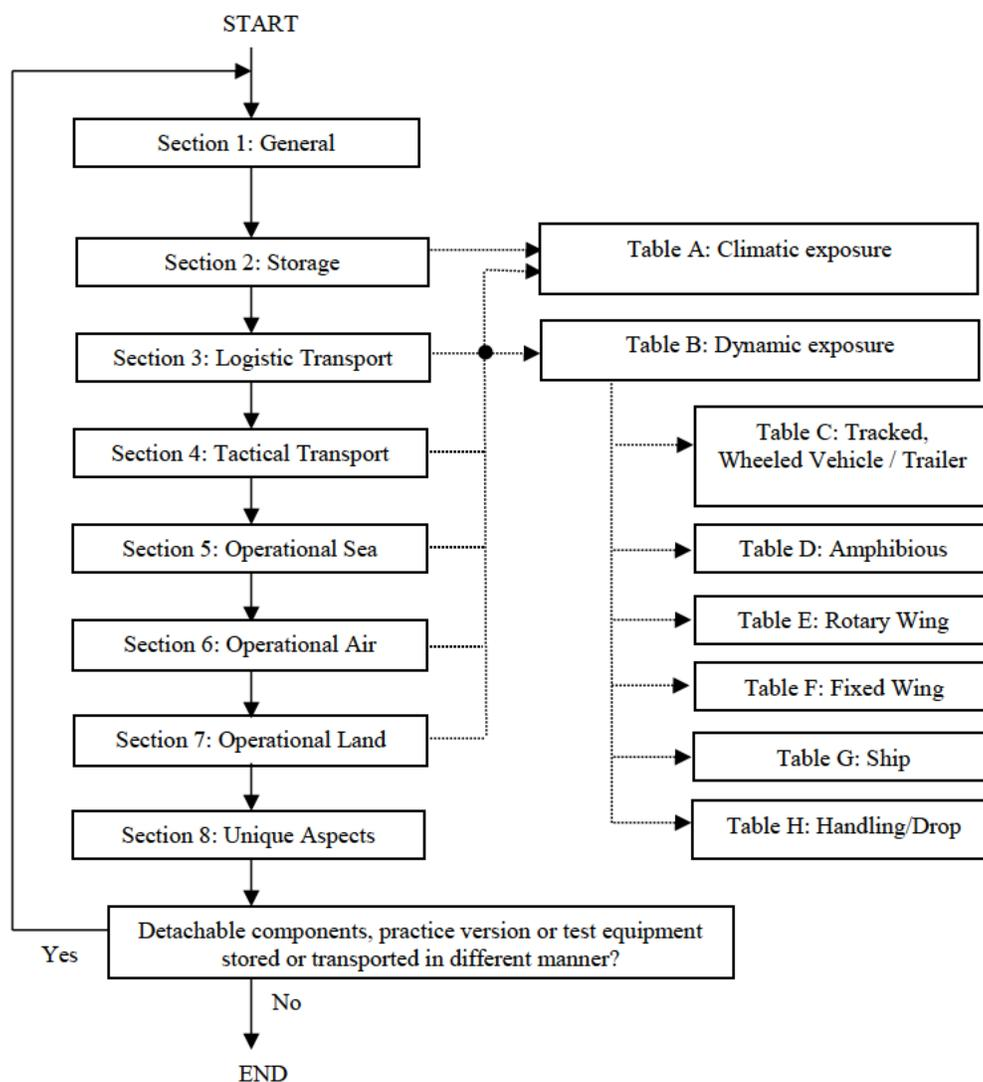


Figure 402-1. Life Cycle Environmental Profile Development Guide

MIL-STD-810H
PART ONE ANNEX A

Section 1: General

No.	Question	Response
1.1	State whether one of the following is applicable for the item: a. detachable components b. practice version available c. in service assembly d. necessary test equipment Will those parts / items be stored and transported separately and/or in a different manner? If so, fill out the questionnaire for each item or component separately.	
1.2	Which of the Services are likely to use this item?	
1.3	State whether the item will be operated from inside an enclosure?	Y / N
1.4	What is the intended total lifetime for this item (including disposal)?	
1.5	May the life be achieved by replacing short-life components during service?	Y / N
1.6	What will be done with items that exceed their service life? (see AECTP-600 for evaluating extended life requirements)	
1.7	If packaged, describe the packaging or protection intended for each of the following situations: a. storage b. transit c. during operation d. any other purpose? Specify role.	Specify: a. b. c. d.
1.8	Is the item or packaging required to be water tight or vapor tight? If yes, will a desiccant be used?	Y / N
1.9	Is the item required to be capable of functioning after exposure to an Electro Magnetic Pulse (exo- or endo-atmospheric)?	Y / N
1.10	Could the item be influenced by other surrounding equipment, like Electromagnetic field(s)?	Y / N

Section 2: Storage

No.	Direction	Completed by
2.1	Complete the storage column of Table A. Climatic zones are described in Part One, Annex C and Part Three of this standard. The storage column of Table A should be completed for all types of storage including storage associated with other phases of the life cycle.	Name: Date:

MIL-STD-810H
PART ONE ANNEX A

Section 3: Logistic Transport

For this section it is assumed that the item is in its logistic packaging or configured for logistic transport. Logistic packaging is intended for transport of, mostly larger amounts of, items to or from the National storage locations. This packaging can vary in the degree of protection it provides for the packaged item, and may or may not contain sub packaging. For transport configuration it is possible that the item will be folded (down), disassembled or provided with a cover or protection.

If these instructions do not cover every situation, please go to the tactical transport section.

No.	Direction	Completed by
3.1	Complete the Logistic Transport column of Table A. Although this requires durations, it may be sufficient to merely indicate the climatic category if these are not known.	Name: Date:
3.2	Complete the Logistic Transport column of Table B and the relevant supplemental tables.	Name: Date:

Section 4: Tactical Transport

For this section it is assumed that the item is in its logistic or tactical packaging or configured for tactical transport. If these questions do not cover any situation, please go to operational sections.

Tactical packaging is intended for transport, over (multiple) shorter distance(s), just before or during operational use. This packaging, mostly, provides less protection than the logistical packaging.

No.	Direction / Question	Response
4.1	Complete the Tactical Transport column of Table A. Although this requires durations, it may be sufficient to merely indicate the climatic category if these are not known.	Completed by
4.2	Complete the Tactical Transport column of Table B and the relevant supplemental tables.	Completed by
4.3	Will the item be transferred at sea horizontal (jackstay) replenishment and in what packaged state?	Y/N

Section 5: Operational Sea

No.	Direction	Completed by
5.1	Complete the Operational Sea column of Table A.	Name: Date:
5.2	Complete the Operational Sea column of Table B and the relevant supplemental tables.	Name: Date:

MIL-STD-810H
PART ONE ANNEX A

Section 6: Operational Air

No.	Direction	Completed by
6.1	Complete the Operational Air column of Table A. Indicate respective exposure in each climatic category for the following: <ul style="list-style-type: none"> a. standby (on the ground/flight deck) b. operating (carriage at altitude) 	Name: Date:
6.2	Complete the Operational column of Table B and the relevant supplemental tables.	Name: Date:

Section 7: Operational Land

No.	Direction	Completed by
7.1	Complete the Operational Land column of Table A. Indicate respective exposure in each climatic category for the following: <ul style="list-style-type: none"> a. standby or installation b. operating or in use 	Name: Date:
7.2	Complete the Operational column of Table B and the relevant supplemental tables.	Name: Date:

Section 8: Unique Aspects

No.	Question	Response
8.1	Is there any situation, condition or external influence which might be expected during the lifetime of the item which is not addressed in the questionnaire?	Detail:

MIL-STD-810H
PART ONE ANNEX A

Table A : Climatic Exposure

Environment	Climatic Zone	Duration ¹ (Indicate the duration of expected exposure for each phase of the Life Cycle)									Other Information
		Storage ²	Logistic Transport	Tactical Transport	Operational Sea		Operational Air		Operational Land		
					Standby	Operating	Standby	Operating	Standby	Operating	
High Temperature	A1										
	A2										
	A3										
	M1										
	M2										
Low temperature	C0										
	C1										
	C2										
	C3										
	C4										
	M3										
Solar Radiation	A1										
	A2										
	A3										
	M1										
	M2										
Humidity	B1										
	B2										
	B3										
	M1										
	M2										

¹ When considering durations for the climatic zones, include all possible deployments and the potential return to storage.

² Storage phase includes long term, short term in theater, and forward base.

MIL-STD-810H
PART ONE ANNEX A

Table A (Continued): Climatic Exposure

Environment	Requirement (indicate during which life cycle phase each environment may occur)									Duration (if known)	Other Information	
	Storage	Logistic Transport			Tactical Transport			Operational				
		Sea	Air	Land	Sea	Air	Land	Sea	Air			Land
Thermal shock												
Immersion												
Fungal Growth												
Salt Fog												
Rain												
Icing												
Pressure (Altitude)												
Sand and Dust												
Contamination by Fluids												
Freeze/Thaw												

MIL-STD-810H
PART ONE ANNEX A

Table A (Continued): Climatic Exposure

Environment	Requirement (indicate during which life cycle phase each environment may occur)									Duration (if known)	Other Information	
	Storage	Logistic Transport			Tactical Transport			Operational				
		Sea	Air	Land	Sea	Air	Land	Sea	Air			Land
Explosive Atmosphere												
Acidic Atmosphere												
Wind												
Green Sea Loading												

MIL-STD-810H
PART ONE ANNEX A

Table B : Dynamic Exposure

Category	Mechanical environment	Table ¹	(Indicate the expected exposure for each phase of the Life Cycle)					Other Information / References ²
			Units	Logistic Transport	Tactical Transport	Operational	Details	
Vibration	Wheeled vehicle / 4-wheeled trailer	C	(km)					
	Tracked vehicle		(km)					
	2-wheeled trailer		(km)					
	Amphibious	D	(km)					
	Rotary wing	E	(hr)					
	Fixed wing	F	(hr)					
	Railroad		(km)					
	Ship-board	G	(days)					
	Submarine		(days)					
	Acoustic		Y/N?					Severe acoustic environment? (> 140 dB)
	Other		(km) or (hr)					
Shock	Handling / Drop	H		Y	Y	Y		
	Munition Launch		Y/N?					
	Air delivery (parachute)		Number?					Packaged state?
	Catapult Launch / Recovery		Y/N?					
	Adjacent launch		(rounds)					Specify adjacent munition
	Pyrotechnic		Y/N?					Specify near / far field
	Gunfire		(rounds)					Specify gun
	Ballistic		Y/N?					Survivability of indirect ballistic impact
	Undex		Y/N?					Still safe and suitable?
Rail impact		Y/N?						
Acceleration	Constant		(g)					Max g?

Note ¹ : Complete Tables for each type / variant identified.

Note ² : Provide other information /references as relevant.

MIL-STD-810H
PART ONE ANNEX A

Table C : Tracked or wheeled vehicle / trailer

Type/ Variant ¹		
Terrain	On road	Off road
Logistic		
Distance		
Avg Speed		
Max Speed		
Tactical		
Shock mounting	Y / N?	Y / N?
Secured cargo	Y / N / Both?	Y / N / Both?
Distance		
Avg Speed		
Max Speed		
Operational		
Shock mounting	Y / N?	Y / N?
Secured cargo	Y / N / Both?	Y / N / Both?
Distance		
Avg Speed		
Max Speed		

¹ To be filled out for each type/variant

Table D : Amphibious vehicle

Type/ Variant ¹			
Terrain	Water ²	On-road	Off-road
Logistic			
Distance			
Avg Speed			
Max Speed			
Tactical			
Shock mounting	Y / N?	Y / N?	Y / N?
Distance			
Avg Speed			
Max Speed			
Operational			
Shock mounting	Y / N?	Y / N?	Y / N?
Distance			
Avg Speed			
Max Speed			

¹ To be filled out for each type/variant

² Complete the water environment for sea and river/littoral if applicable.

MIL-STD-810H
PART ONE ANNEX A

Table E : Rotary Wing

Type/ Variant ¹		
Logistic		
Duration internal [hrs]		
Duration underslung [hrs]		
Delivery at sea (vertical replenishment)		Y / N, Specify sea state
Tactical / Operational		
Duration once [hrs]		
Duration cumulative [hrs]		
Adjacent stores		Y / N, Specify adjacent stores
Projected mission profile		
Number of take off's / landings		
Cruise [% of operational duration]		
Tactical Maneuver [% of operational duration]		
Attack [% of operational duration]		
Show of force [% of operational duration]		

¹ To be filled out for each type/variant

Table F : Fixed Wing

Type/ Variant ¹		
Logistic		
Duration [hrs]		
Tactical / Operational		
Duration once [hrs]		
Duration cumulative [hrs]		
Adjacent stores		Y / N, Specify adjacent stores
Projected mission profile		
Number of take off's / landings		
Cruise [% of operational duration]		
Tactical Maneuver [% of operational duration]		
Attack [% of operational duration]		
Show of force [% of operational duration]		

¹ To be filled out for each type/variant

Table G : Shipboard

Type/ Variant ¹	Duration [days]		
	Logistic	Tactical	Operational
Masthead			
Exposed upper deck			
On or adjacent to a flight deck or helicopter landing pad			
On or near a designated vehicle park			
Protected compartment			
Hull, below water line			

¹ To be filled out for each type/variant

MIL-STD-810H
PART ONE ANNEX A

Table H : Handling / Drop

Handling / Drop category ¹		Logistic transport		Tactical transport / Operational	
		Packaged	Unpackaged	Packaged	Unpackaged
Ship transport	Y / N?				
Man carried					
Forklift					
Crane					
Vehicle (un)loading					
Bench handling					
Other	Specify:				

¹ If known, state specific height for above environment.

MIL-STD-810H
PART ONE ANNEX A

TASK 403

OPERATIONAL ENVIRONMENT DOCUMENTATION (OED)

403.1 Purpose. This is one of three tasks (Task 402, 403, and 404) completed by one or more environmental engineering specialists (combat/materiel developer staff or contractor) whose products comprise the Environmental Test and Evaluation Master Plan (ETEMP). To develop the Environmental Issues/Criteria List called for in Task 404, it may be necessary to obtain specific data that describe the environmental conditions laid out in the Life Cycle Environmental Profile established through Task 402. These data, the OED, are produced by preparing a plan and a report: the Operational Environment Documentation Plan (OEDP), to obtain data that will serve as the basis for design and test criteria development; and the Operational Environment Documentation Report (OEDR), that contains the OEDP and the data called for in that plan.

403.2 OEDP subtask description. The Operational Environment Documentation Plan (OEDP) provides for two types of data. First, it contains plans for obtaining data that already exist and are valid for developing the materiel design and test criteria. Second, it contains plans for collecting data not available currently, describing how to obtain those environmental data under realistic operating or field conditions using actual or closely related systems/platforms. As a minimum, perform the following subtasks and include subtask products in the OEDP:

403.2.1 Obtain available field/fleet data. Prepare a list of field/fleet data descriptions of materiel or platform environment conditions that can be used to develop environmental issues and criteria. Include the list in the OEDP. Adhere to all of the following guidelines:

- a. Materiel similarity. Whenever practical, obtain data on the same type of materiel on the same platform type that will carry the materiel to be tested. This ideal situation is often unattainable early in the development of new materiel. Therefore, it is sometimes necessary to derive data from appropriately similar materiel or carrying platforms. Under such circumstances, exact equivalence would not be expected nor required. It is important to note that materiel may be functionally dissimilar but still be considered comparable for documenting environmental stress conditions.
- b. Data quality. Satisfy the following minimum standards before considering field data suitable for use as criterion values in laboratory test procedures. Obtain, analyze, and format field data to be compatible with the specific test procedure for which those data are being considered as criteria. Include the following supporting information:
 - (1) A description of the materiel or the carrying platform.
 - (2) The location on the materiel or carrying platform at which the measurements were made.
 - (3) The ambient environmental and operating conditions under which the measurements were made.
 - (4) The type and calibration status of data recording and analysis equipment and instrumentation.
- c. Data quantity. Sufficient and traceable data are needed to adequately describe the conditions being evaluated, but the definition of sufficiency will vary with the environmental conditions, physical and performance characteristics of the hardware type, and program needs. Some engineering judgment may be required to assess the applicability of data when constraints limit the number and location of measurement points. As a minimum, consider:
 - (1) The number and nature of data points.
 - (2) The number and scope of test trials.

403.2.2 Develop plans for new data. When field/fleet data are not available (in data bases or other data sources) to describe specific environmental conditions, develop plans to acquire these needed data under actual service conditions. Prepare a list of new data requirements that can be used to develop environmental issues and criteria. Prepare plans for obtaining these new data. Include the list and the plans in the OEDP. In addition to following the guidelines and providing the information required in 403.2.1, above, for available data, include the following in the OEDP:

- a. A description of precisely what data are to be collected and to what degrees of accuracy.
- b. A description of the materiel locations at which measurements are to be made.
- c. Identify the instrumentation to be used to make these measurements.
- d. Provide mission profile time histories, durations, and the number of tests for which environmental measurements are to be made.
- e. Describe the assets and personnel to be provided by the procuring activity to obtain the required data, including vehicles, facilities, and information collection and processing equipment.

MIL-STD-810H
PART ONE ANNEX A

- f. Provide schedules for acquiring data.
- g. Identify the geographic locations at which measurements are to be made.
- h. Identify points of contact and lines of communication between the procuring activity and the contractor environmental engineering organizations.

403.2.3 Details to be provided by the acquisition agency.

- a. Platforms and personnel availability for acquiring data.
- b. Geographic locations available for data acquisition.
- c. Data acquisition instrumentation and analysis equipment available at test sites.

403.3 Operational Environment Documentation Report. The OEDP, along with the data resulting from its implementation, form the Operational Environment Documentation Report (OEDR).

MIL-STD-810H
PART ONE ANNEX A**TASK 404****ENVIRONMENTAL ISSUES/CRITERIA LIST (EICL)**

404.1 Purpose. This task, completed by one or more environmental engineering specialists (combat/materiel developer staff or contractor), provides a list of issues and criteria that cover the effects that various environments have on materiel performance and reliability. It includes design and test criteria and issues, and their supporting rationale and assumptions. This is one of three tasks (Task 402, 403, and 404) that make up the Environmental Test and Evaluation Master Plan (ETEMP). Critical issues and basic criteria may appear in the CONOPS, SRD, ICD, CDD and the CPD. Environmental design and test issues/criteria are derived from the LCEP and OED data.

404.2 Task description. For each environmental stress type or combination of stress types to be considered in materiel design/testing, include the following information, as a minimum, in the EICL. Note that design and test criteria may not be the same in all cases because some form of time compression, stress exaggeration, or other simplifying assumptions may be needed to perform tests, particularly laboratory tests, in a practical schedule with available facilities. However, test criteria must always be tailored realistically.

- a. Develop specific design and test criteria (including specific criterion values) and their associated critical issues. Include these issues and criteria in the EICL.
- b. Develop rationale and assumptions used to select the specific criteria, including the significance of the criteria with respect to materiel performance and durability, and including factors of conservatism. Include these in the EICL.
- c. Explain differences between design and test criteria, including test compression algorithms, fatigue acceleration models, and test facility limitations.
- d. Estimate expected degree of correlation between laboratory test results and anticipated service experiences.

404.3 Details. Details to be provided by the acquisition agency.

- a. Service scenarios of greatest concern for performance and durability.
- b. Data analysis methodologies (optional).
- c. Test time compression algorithms or stress models (optional).

MIL-STD-810H
PART ONE ANNEX A

TASK 405

DETAILED ENVIRONMENTAL TEST PLANS (DETP)

405.1 Purpose. This task calls for detailed plans for conducting environmental tests required to determine if the environmental criteria developed in Task 404 are met and their associated critical issues are satisfied, and to identify critical environmental threshold values for system effectiveness that may be evident during testing. Environmental test plans are prepared by materiel developers, evaluators, assessors, and testers in various levels of detail during the acquisition cycle. Development and operational testers prepare plans for testing in laboratory and natural field/fleet environments.

- a. Laboratory test plans. This task pertains mainly to plans for materiel tests performed in environmental laboratories. The laboratory DETP provides the acquisition activity with plans for environmental laboratory tests early in the development cycle.
- b. Natural environment field/fleet tests. The information in 405.2 and following may be used as examples of some of the types of environmental testing procedures that are useful guidelines for some development and operational test plans. These plans are influenced automatically by previous environmental engineering tasks. Agency EES normally assist in preparing these plans.

405.2 Approach. Use decisions and data obtained through the tailoring process to determine the need for laboratory tests, specific criterion values (settings) for the individual environmental test methods in Part Two of this document, and the types and timing of development or operational tests in natural environments. Early coordination with the development and operational test community is essential to facilitate preparation of DETPs and to avoid costly omissions or duplications in environmental test planning. Consider the following:

- a. Probability of occurrence of specific environmental forcing functions, alone or in combination.
- b. Occurrence of similar environmental stresses in more than one life profile phase.
- c. Experience from other materiel similarly deployed/tested.
- d. Expected environmental effects and materiel failure modes.
- e. Expected effects on hardware performance and mission success.
- f. Likelihood of problem disclosure by a specific laboratory test method using a specific chamber test sequence/setting or natural environment test location/method.

405.3 Contents. Include the following in DETPs:

405.3.1 Pretest information. Include the following in the test plan as information that is required prior to conducting an environmental test.

- a. Background data of each item:
 - (1) Item nomenclature, model, serial number, manufacturer, etc.
 - (2) General appearance/condition.
 - (3) Specific physical anomalies.
 - (4) Environmental test history of the specific test item.
- b. Pretest data on the functional parameters that will be monitored during and after the main test. Use functional parameters and operational limits specified in the materiel specification or requirements document. If such specifications are not provided, establish and apply appropriate parameters/limits for the pretest, during the test, and the post test.
- c. Pretest information for facility operators. (Additional information may be required in specific methods in Part Two of MIL-STD-810H.)
 - (1) Test facilities (if applicable) including instrumentation.
 - (a) apparatus
 - (b) fixture(s)
 - (c) heating or cooling provisions
 - (d) requirements for combined environment
 - (2) Test item installation details.
 - (a) procedures for installation including test item configuration relative to a fixture

MIL-STD-810H
PART ONE ANNEX A

- (b) orientation
- (c) interconnections
- (d) pretest setup photographs as appropriate
- (3) Test instrumentation, monitoring, and recording.
 - (a) schedule
 - (b) individual test duration of exposure
 - (c) axes of orientation
 - (d) level criteria and tolerances
 - (e) method of test stress application
 - (f) shutdown procedures
 - (g) completion criteria
 - (h) test item functional and operational requirements for pretest, during test, and post test
- (4) Test procedure:
 - (a) schedule
 - (b) individual test duration of exposure
 - (c) axes of orientation
 - (d) level criteria and tolerances
 - (e) method of test stress application
 - (f) shutdown procedures
 - (g) completion criteria
 - (h) test item functional and operational requirements for pretest, during test, and post test

405.3.2 During test information. Include the following in the test plan as data to be collected during the test.

- a. Environmental design parameters and test criteria.
- b. Test configuration and quantity of items to be tested.
- c. Description of the testing to be performed, including specific climatic categories in which tests are conducted, subtests (e.g., initial examination (including packaging adequacy), pretest data (see 405.3.1, above), storage, performance, operational modes, human factors, safety, etc.), and failure criteria.
- d. Test procedure criteria, limits and tolerances.
- e. Test sequence and schedule.
- f. Test instrumentation, including, but not necessarily limited to:
 - (1) Specific instrumentation, calibration criteria, and procedures.
 - (2) Data to be collected and accuracies to be achieved.
 - (3) Description of all filtering performed on data.
 - (4) Specific photographs and video.
- g. Descriptions of test installations, facilities, and equipment currently available to the contractor or available for procurement for the specific test program.
- h. Facilities/equipment required from the Government and dates required.
- i. Data reduction/analysis techniques and statistical criteria.

405.3.3 Post test information. Include the following in the test plan as information that is required after conducting the main test.

- a. Test item identification (manufacturer, model/serial number, etc.).
- b. Test equipment identification, including accessories.
- c. The actual test sequence (program) used or procedural anomalies.
- d. Deviation from the planned test program (including explanation).
- e. Performance data collected on the same parameters at the same operational levels as those of the pretest (including visual examination results and photographs, if applicable).
- f. If not tested in a chamber (e.g., vibration test), room ambient test conditions recorded periodically during test period.

MIL-STD-810H
PART ONE ANNEX A

- g. Other data as specified in the individual methods or materiel requirements document(s).
- h. Initial failure analyses.
- i. A signature and date block for the test engineer/technician to certify the test data.
- j. Photographic record of the test item, test fixture, and test apparatus, as appropriate.

MIL-STD-810H
PART ONE ANNEX A**TASK 406****ENVIRONMENTAL TEST REPORT (ETR)**406.1 Purposes.

- a. Environmental test reports are produced at various points in the acquisition process by development and operational testers. Specifications for reports of development and operational tests in specific environments are provided by development and operational test agencies and, therefore, do not appear here. However, the information in 406.2 may be used as examples of some of the types of information that could appear in development and operational test reports.
- b. This task pertains mainly to the results of materiel tests performed in environmental laboratories. The ETR provides the acquisition activity with environmental laboratory test data early in the development cycle. The laboratory ETR is appropriate for design evaluation tests, operational worthiness tests, and qualification tests. Data from these laboratory tests serve as early warnings of unanticipated deviations from performance requirements. They support failure analyses and corrective actions related to the ability of materiel items to survive specific environmental conditions. These laboratory test reports (neither singularly nor in aggregate) are not substitutes for reports of development or operational tests conducted in natural field/fleet environments.

406.2 Task description. For each laboratory test conducted, provide the following:406.2.1 General information.406.2.1.1 Main body. Include the following in the main body of the report:

- a. Test item identification.
- b. Functional description of the failed or affected parts of the materiel.
- c. Causes of failures, if known.
- d. Proposed corrective actions if determinable.
- e. Test conditions (quantitative and qualitative data on environmental parameters of test).

406.2.1.2 Attachments. Include the following as attachments:

- a. Incremental test log (including time and events between failures).
- b. Laboratory failure analysis reports (that identify the physics-of-failure to the extent possible).
- c. A list of all other development and production activities where the same part failed, for example:
 - (1) Environmental tests
 - (2) Reliability tests
 - (3) Screening tests
 - (4) Bench checks
 - (5) Acceptance test procedures

406.2.2 Content requirements.406.2.2.1 Interim test reporting. Unless otherwise specified, accomplish this reporting by letter.

- a. Interim Report. Report accomplishment of an environmental test by way of a letter report. Identify the specific test accomplished, salient test parameters and conditions, important test results, any failures that occurred, and proposed corrective actions.
- b. Test anomaly notification. When a test anomaly occurs, prepare a test anomaly letter to the procuring activity. Briefly summarize the test anomaly and include the following information:
 - (1) Materiel serial numbers.
 - (2) Description of the anomaly (test interruption caused by test facility or test equipment failure, or materiel item failure).
 - (3) Environmental conditions surrounding the anomaly.
 - (4) Materiel failed part identification, if known at the time the anomaly letter is written.
 - (5) Test anomaly analysis and corrective action. Include an analysis of the causes of a test anomaly and the corrective action taken to prevent its recurrence. Prepare a short letter for one or more test anomalies that are

MIL-STD-810H
PART ONE ANNEX A

simple in nature and have simple correction actions. For a materiel failure, prepare a more detailed notification letter.

406.2.2.2 Final test report. Document engineering development or qualification testing for each test (single environment or combined environmental test) for which testing was accomplished. Include in the final report for each test:

- a. The purpose of the test (i.e., engineering development, qualification, environmental worthiness, etc.).
- b. A list of criteria and issues pertaining to the test.
- c. Description of test item, including configuration identification of test hardware and photographs as appropriate.
- d. Description of test parameter, test duration, and any special conditions involved in the test.
- e. Description of test method, facility, and test procedure. Include a detailed description of how the test item was operated during each test and any controlled conditions.
- f. Test set-up diagram/photos. Show arrangements of test item relative to test equipment used.
- g. A list of all test equipment used in the test. Identify manufacturer, model, calibration status, and serial number for each item of test equipment listed.
- h. Location of environmental sensors such as accelerometers, microphones, thermocouples, etc., relative to test item. Use diagrams and photographs as appropriate.
- i. Description of test instrumentation system with particular emphasis given to any sensor averaging.
- j. Test results. Insert conversion tables (metric).
- k. Deviations from the original test plan.
- l. Analysis of results relating data to criteria, including data reduction techniques and procedures showing how the data were related to the criteria, and a met/not met statement for each criterion.
- m. Record of critical values. In situations when environmental conditions limit or significantly degrade system performance (e.g., fog limiting infrared sensor system effectiveness, etc.), describe the limitation and designate it in the final test report as a critical threshold value.

MIL-STD-810H
PART ONE ANNEX B**PART ONE ANNEX B****DETAILED PROGRAM MANAGEMENT GUIDANCE**

- A. General. Materiel must perform adequately under all environmental conditions associated with its service life; withstand those conditions in transit and storage, and maintain the desired level of reliability after environmentally harsh operation, storage, and transit. In order for this to happen, the effects that environmental conditions have on materiel effectiveness and safety must be determined, considered, analyzed, and integrated into all aspects of the acquisition process as indicated in Part One, Figures 1-4a and b. The guidance provided here and throughout this entire Standard applies to the effects of environments on systems rather than the effects of systems on environmental quality. Therefore, the thrust of this Standard should not be confused with Environmental Impact programs that focus on how to preserve and protect flora and fauna from service personnel, their materiel, and their activities. Conversely, this Standard pertains to the effects that environments have on materiel system effectiveness.
- B. Environments of intended use.
1. Several sections of the DoD 5000-series on Defense Acquisition address environmental considerations, stressing that a system will be demonstrated in its intended environment (DoDI 5000.02). Unlike other technical areas (e.g., reliability, electromagnetic environmental effects, human factors, and environmental quality), no single section of that series is devoted to addressing natural or induced environmental factors. Therefore, this Part One provides basic program procedures for integrating environmental factors into the materiel acquisition process. This integration is accomplished through input to acquisition planning documents from the Mission Need Statement through the Test and Evaluation Master Plan to detailed test and evaluation plans and reports.
 2. Environmental factors, working separately and in various combinations, are known to affect operation, transit, and storage of materiel. The DoD 5000-series documents point out that these factors include climate (temperature, humidity, solar radiation, rain, snow, icing phenomena, wind, blowing sand, dust and snow, ozone, freeze-thaw occurrences, fog, cloud ceiling height, and visibility); weather-related atmospheric obscuration (rain, snow, fog, cloud cover); terrain elements (slope, soil, and vegetation); induced elements (shock and vibration); and field/fleet conditions (obscuration, debris, emissions). Environmental Engineering Specialists (EES) are trained to assist acquisition personnel throughout the acquisition cycle to integrate these environmental concerns into requirements, design, test and evaluation documents, and procedures. See Annex A of this document.
- C. Balancing cost, schedule, and performance considerations. One of the basic policies governing defense acquisition covers the need to translate operational needs into stable, affordable programs. The key to this is using a concurrent systems engineering approach to help ensure reliable performance in all operational environments, when required. This entails designing a product to perform its assigned mission over time in intended operational environments and, at the same time, designing the system to survive non-operational environments (e.g., storage).
- D. Trade-off considerations. Evaluate the need to operate in extreme environments against other factors such as cost, technical feasibility, tactics, doctrine, and materiel platforms. Higher costs, logistical problems, and operational difficulties associated with these environmentally rigorous areas could lead to selecting one of the following:
1. Special materiel capable of operation in extreme environmental areas.
 2. Special materiel solely for extreme environments.
 3. Modification kits that adapt new standard materiel or previously type-classified materiel to such use.
 4. Special design values that are more extreme than normal tailoring would suggest for materiel whose failure to operate would be life-threatening.
 5. Special design for materiel that would be useless or dangerous after one-time exposure.
- E. Testing materiel for environmental effects. Developmental and evaluation plans must consider environmental effects outlined in the life cycle environmental profile. Both chamber tests and field/fleet tests serve useful purposes. Apply them at appropriate times during the acquisition cycle. Except for reasons of safety, chamber tests cannot be substituted for field/fleet development tests because unknown synergistic/antagonistic effects from combined/induced environments cannot be built into chamber/laboratory test methods. An example where chamber testing may be substituted for field/fleet testing is ammunition conditioning prior to test firing. Following are some guidelines for laboratory testing, natural field/fleet development testing, and operational testing.

MIL-STD-810H
PART ONE ANNEX B

1. Laboratory testing. Conduct laboratory tests early in the development stage to screen materiel for environmentally caused problems that may degrade materials, performance, or reliability. Conduct laboratory tests according to the general tailoring guidance in Part One, and the specific testing guidelines in Part Two of this Standard.
 2. Natural field/fleet development testing. Conduct natural environmental field/fleet development tests to determine the true effects of the real environment. This will allow system assessment of synergistic/antagonistic effects of natural environmental factors combined with human factors, and induced factors such as shock/vibration, smoke/obscurants, and electromagnetic interference. Use established natural climatic test centers and standard test procedures to obtain data that may be compared to previous/following test data, and to develop data bases that may be used for simulations.
 3. Operational testing. Conduct operational testing in natural environments that are as realistic as possible. When operational testing cannot subject materiel to the desired ranges of environmental stresses and deterioration that may be encountered during actual operation and storage and transit, development test environmental effects data may be substituted for operational test environmental effects data.
- F. Analytic alternatives to testing actual hardware. In some instances, there may be analytic alternatives to testing actual systems or hardware prototypes in laboratories or in field/fleet environments. An EES can help to establish an engineering basis for selecting and implementing such alternatives. When alternatives to testing actual hardware or prototypes are chosen, Task 401, Environmental Engineering Master Plan, must contain the rationale for their selection, including an explanation of the cost savings, other benefits, and risks to system effectiveness/safety. (See Part One, paragraph 4.1.2b; Annex A, Task 401.) Analytic alternatives include, but are not necessarily limited to the following.
1. Modeling and simulation. Modeling and simulation (M&S) is useful in representing conceptual systems that do not exist, nascent technologies, and extant systems that cannot be subjected to actual environments because of safety requirements or the limitations of resources and facilities (DoDI 5000.02). Modeling and simulation techniques should be used only to the extent that their predictive validities have been verified. They are not intended to be substitutes for tests in natural field/fleet environments. Simulation can reduce high costs involved in producing and testing hardware prototypes. Although artificial intelligence and software simulations may be integral parts of models, neither these types of data nor data from laboratory tests should be used to validate models. The soundest criteria for developing and validating models and simulations come from real world, field/fleet data or knowledge bases. To that end, all fields of science and engineering can help to save costs through simulation by developing or contributing to data bases or knowledge bases that cover the entire domain of environmental effects. (See Annex C, paragraph B.)
 2. Testing coupon samples. In some instances, particularly in laboratory tests and natural field/fleet exposure/surveillance tests, there may be significant savings by using coupon samples instead of entire systems when specific materials are the central acquisition issue.
 3. Acceptance by similarity. In cases where materiel considered for testing is nearly identical to materiel already tested, and there is no reason to believe that the differences between them would pose an environmentally induced problem, the Program Manager may consider accepting the materiel by virtue of its similarity to the similar materiel already accepted.
- G. Type classification process. Environmental considerations influence the type classification process. For materiel that is designated by the combat developer to be critical to combat success, type classification or fielding may be barred if environmental testing reveals that environmental effects were not considered adequately and incorporated in the design of the system. Additionally, successful system performance and reliability in natural environments are listed as critical issues in Milestone III (production) decisions.

MIL-STD-810H
PART ONE ANNEX C**PART ONE ANNEX C**
**ENVIRONMENTAL TAILORING GUIDELINES FOR ENVIRONMENTAL
ENGINEERING SPECIALISTS (EES)**

A. General. Environmental tailoring is the process of choosing or altering materiel designs and tests so that a given materiel will be manufactured and tested to operate reliably when influenced by the various environmental factors and levels it is expected to experience throughout its service life. The tailoring process, broadly speaking, also includes preparing or reviewing engineering task and planning documents to help ensure realistic environments are given proper consideration throughout the acquisition cycle.

1. Objective of tailoring. Tailoring helps to ensure materiel will be neither under- nor over-designed, nor under- nor over-tested with respect to specific environments it is expected to see during its service life. The tailoring process outlined in Part One, Figure 1-3 shows that it is important not to take design and test criteria directly from natural environment data (descriptions of natural environmental factors or forcing functions found in NATO STANAG 4370, AECTP 230, MIL-HDBK-310, and AR 70-38), but rather from the transformations that such forcing functions create as they interact with a platform environment (static or dynamic materiel platforms, including induced environmental changes that result from operating the materiel itself).
2. Tailoring process. Fundamental to the tailoring process is the ability to apply common scientific/engineering sense to environmental life cycle "homework," focusing on realistic materiel design and test criteria. To execute a quality tailoring process, it is necessary to give proper consideration to environments that occur throughout the materiel's life cycle. Completing Tasks 401 through 406 in Annex A will help Program Managers and environmental engineering specialists to apply proper environmental considerations throughout the materiel acquisition cycle. Part One, Figure 1-1 explains the tailoring process in terms of the environmental engineering tasks (Annex A) required by this Standard, thereby serving as a guide for Program Managers, design engineers, environmental engineering specialists, test engineers, and facility operators. Use Task 401, Environmental Engineering Management Plan (EEMP), and Task 402, Life Cycle Environmental Profile (LCEP) as the main guides for tailoring. Careful completion of each of these tasks will help ensure correct environments are identified for tests, that engineering development as well as qualification tests are phased properly into the materiel's acquisition program, and that environmental test conditions are appropriate and traceable to realistically encountered life cycle conditions.

B. Environmental testing domain.

1. Acquisition personnel. Acquisition personnel, with the assistance of an EES, should derive environmental development and operational test plans according to the environmental tailoring process shown in Part One, Figures 1-1 and 1-4a and b. All types of environments need to be addressed. In the broader sense, environmental considerations go beyond basic climatic factors (such as temperature and humidity) to complex combinations and sequences of factors (such as rapid heating and cooling in high humidity, intermittent rainfall, high microbial activity, and vibration conditions) that can combine synergistically or antagonistically to influence materiel effectiveness. Therefore, the domain of environmental testing goes beyond the laboratory test methods appearing in Part Two of this standard. The broader objective of environmental effects tailoring is to determine optimum design and test specifications for the expected environmental classes such as:
 - a. Natural
 - Climate
 - Terrain
 - b. Induced
 - Shock/vibration
 - Noise
 - Light
 - Electromagnetic radiation
 - c. Constructed

MIL-STD-810H
PART ONE ANNEX C

- Built up areas
 - Transportation facilities
 - Communication facilities
 - Energy sources
 - d. Conflict
 - Permanent fortifications
 - Persistent debris/emissions
 - Transitory obscurants/emissions
 - 2. Performance of laboratory tests. Conduct the laboratory tests in Part Two early in the acquisition cycle to the extent that they can reveal environmentally caused materiel problems early in the acquisition process before the problems become costly to solve. These laboratory test methods cannot be used as substitutes for field/fleet test methods that measure materiel performance, reliability, safety, and other important aspects of materiel evaluation in natural field/fleet environments. The reason is inherent in the many combined effects that can occur in nature and on materiel platforms in field/fleet operations. By performing the tasks in Annex A, EES from government and industry can assist combat developers, materiel developers, Program Managers, etc., to select factors within each of the environmental classes, tailoring them to the specific materiel application. Different EES may be used in different phases of the acquisition cycle (e.g., system design and system assessment) to maintain independence of those functions.
- C. Climatic categories. One of the vital challenges of the tailoring process is to design materiel to operate in climates of the world in which the materiel is expected to be deployed. Five Climatic Categories may be called out in mission need, materiel requirement, design, and test documents for tailoring purposes: Basic, Hot, Cold, Severe Cold, and Coastal/Ocean. The Basic Climatic Category covers a broad range of climatic conditions in which most materiel should operate and survive storage and transportation. Coastal/Ocean is a relatively new category that may not appear in other documents that describe climates. All categories are described below. Within each category there are one or more "daily cycles" primarily based on variations in temperature and relative humidity levels. All Climatic Categories, except for Coastal/Ocean, are defined in Table C-I and mapped on Figures C-1 through C-3. For further details on the Coastal/Ocean Climatic Category and other outdoor ambient worldwide and regional climates, see NATO STANAG 4370, AECTP 230, MIL-HDBK-310, and AR 70-38.
1. Hot Climatic Category. This Climatic Category includes most of the hot-dry low-latitude deserts of the world. During summer in these areas, outdoor ambient air temperatures above 43°C (110°F) occur frequently. However, except for a few specific places, outdoor ambient air temperatures will seldom be above 49°C (120°F). These approximate temperatures of the free air in the shade approximately 1.5 to 2 meters (about 5 or 6 feet) above the ground (in an instrument shelter). The thermal effects of solar loading can be significant for materiel exposed to direct sunlight, but will vary significantly with the exposure situation. The ground surface can attain temperatures of 17 to 33°C (30 to 60°F) higher than that of the free air, depending on the type/color of the ground surface, radiation, conduction, wind, and turbulence. Air layers very close to the surface will be only slightly cooler than the ground, but the decrease in temperature with height above the surface is exponential. Temperatures at approximately 0.5 to 1 meter (about 2 to 3 feet) will be only slightly warmer than that observed in an instrument shelter at about twice that height.¹ In winter, such temperatures are likely to be in the same range as for the Basic Climatic Category. If materiel is designed only for the hot climate, seek a specially tailored low outdoor ambient air temperature design value. Small portions of this area are sometimes subject to very high absolute humidity. However, in these hot-wet areas, the highest outdoor ambient air temperatures and highest dew points do not occur at the same time.
 2. Basic Climatic Category. This includes the most densely populated and heavily industrialized parts of the world as well as the humid tropics. The entire range of basic design conditions does not necessarily occur in any one place. Each single condition (high temperature, low temperature, high humidity) occurs in a wide area. When taken together, the design values should be valid for materiel used throughout the area.

¹ Synopsis of Background Material for MIL-STD-210B, Climatic Extremes for Military Equipment, Norman Sissenwine & Rene' V. Cormier, 24 January 1974.

MIL-STD-810H
PART ONE ANNEX C

- a. Humid tropic zone. Humid tropic areas are included in the Basic Climatic Category rather than being considered an extreme category because humid tropic temperatures are moderate and their humidity levels are equaled at times in some of the other mid-latitude areas. The features of the humid tropics most important for materiel system design are moderately high temperatures and high rainfall throughout the year that spawn persistent high humidity and high flora and fauna diversity. These combined environmental conditions greatly increase insect and microbiological damage and promote corrosion more so than any other region of the world. This is important for DoD's Corrosion Prevention and Control Program (DoDI 5000.02).
 - b. Intermediate zone. These are mid-latitude areas that do not combine higher temperatures with higher humidities throughout the year, and at the same time are not climatically extreme enough to meet the conditions for Hot or Cold Climatic Categories. This zone includes the daily cycles shown in Table C-I, plus a condition known as "cold-wet" that can occur within the mild cold daily cycle at or near the freezing point (2 to -4°C (35 to 25°F)) with relative humidity tending toward saturation (100 to 95 percent RH) and negligible solar radiation.
3. Cold and Severe Cold Climatic Categories. These areas include northern North America, Greenland, northern Asia, and Tibet. In the Cold Climatic Category, the temperature during the coldest month in a normal year may be colder than the Basic Climatic Category cold extreme of -32°C (-26°F). In the Severe Cold areas, the temperature during the coldest month in a normal year may be colder than the Cold Climatic Category extreme of -46°C (-51°F). Temperatures colder than -51°C (-60°F) occur no more than 20 percent of the hours in the coldest month of the coldest part of the area (northern Siberia) where temperatures as low as -68°C (-90°F) have been recorded. Because extremely low temperatures are not controlled by a daily solar cycle, they persist for a long enough period of time to cause materiel to reach equilibrium at extremely low temperatures.
 4. Coastal/Ocean Climatic Category. These areas include open seas and coastal ports north of 66°33'S. The area south of 66°33'S, the Antarctic Circle area, is excluded because of extremely harsh conditions that would call for special, case-by-case designs outside of the scope of the conditions/procedures covered in this Standard, and because military conflicts are highly unlikely in this international area. In general, materiel should be designed to operate in the Coastal/Ocean Climatic Category during all but a small percentage of the time when routes may be closed to navigation because of sea ice. See NATO STANAG 4370, AECTP 230, MIL-HDBK-310, and AR 70-38 for details.
- D. Considerations for determining climatic categories for materiel systems.
1. Normal environment considerations. All combat and combat support systems should be designed for at least the Basic Climatic Category, meaning that design temperatures will include the outdoor ambient air temperatures range of -32°C (-26°F) through +43°C (109°F). See Figure C-1 and Table C-I. In addition, Tables C-II through C-IV contains a summary of potential environments an item may encounter during its life cycle.
 2. Extreme environment considerations. Materiel intended to be deployed or used in extreme climates (hot, cold, and severe cold), in areas with extreme non-thermal weather conditions (such as blowing sand and dust), or in areas with mobility-restricting terrain conditions (such as tundra soil and heavily forested areas) will require additional planning, design, and testing considerations. In addition to being prepared for the Basic Climatic Category, most materiel will need to be designed, developed, tested, and evaluated for operation, storage, and transit conditions in areas of the world that experience extreme temperatures. According to NATO STANAG 4370; AECTP 230, MIL-HDBK-310; and AR 70-38; to qualify as an area of extreme temperature, the area must meet one of the following two conditions: (1) have one percent or more of the hours in the hottest month equal to or exceeding 43°C (109°F); (2) have one percent or more of the hours in its coldest month equal to or lower than -32°C (-26°F). The areas that have more extreme temperatures than these are the Hot, Cold, and Severe Cold Climatic Categories shown on Figure C-1 and Table C-I. In addition, Tables C-II through C-IV contain a summary of potential environments an item may encounter during its life cycle.

MIL-STD-810H
PART ONE ANNEX C

3. Special considerations for materiel categories/modes.
- a. Storage and transit. When preparing a materiel's mission profile, life cycle environmental profile, or an SRD, identify storage and transport environments and environmental limits that the materiel is required or desired to withstand (e.g., temperature, humidity, vibration levels, etc.). For severe storage/transport conditions that would generate high materiel costs to withstand, consider modifying storage/transit/platform conditions/designs as tradeoffs to materiel design requirements. Environmental conditions for storage and transit modes may be more severe than those of operational modes because of the possibility of induced/combined environments (e.g., heat, humidity, shock, vibration, etc.), higher levels of some factors (e.g., high temperature in temporary open storage or during delays between transit modes), or greater materiel exposure times.
 - b. Design of sheltered materiel. This paragraph pertains to materiel that is intended to be deployed/operated within shelters. In this case, the shelter becomes the materiel platform, and the environmental characteristics that the sheltered materiel will see depend upon the location and design of the shelter. Not only design sheltered materiel to be transported (as part of a shelter assembly) to its use location, but also design it to be used under the conditions that exist within the shelter when the shelter is operated in the areas stipulated in its requirements documents. This includes storage conditions within shelters that are not controlled environmentally as well as operational conditions where environments are controlled. Also, design sheltered materiel to withstand environmental effects that occur during materiel relocation when the shelter is not available. The materiel developer should:
 - (1) Develop or supply protective devices or modification kits, if required, that will permit shipment, storage, and operational use of such materiel in the environmental conditions for which it is intended.
 - (2) Indicate by distinct marking at appropriate places on the materiel (where size makes this feasible), and by warning statements in technical manuals, the actual climatic stress limits that should not be exceeded in operational and non-operational modes.
 - c. Effects of environments on user/system interfaces. As part of each materiel analysis conducted during the materiel acquisition cycle, the developmental and operational evaluators must consider environmental effects on the user/system interface. Special tests may be needed to address personnel survivability and habitability issues to ensure that crews can sustain operations in operational environments (DoDI 5000.02).
 - d. Environmental considerations for potentially dangerous materiel. Design potentially dangerous materiel (e.g., ammunition and explosive materials/materiel, etc.) to include safety requirements based on the long-term, worldwide temperature extremes detailed under NATO STANAG 4370, MIL-HDBK-310, and AR 70-38, even though the materiel may not be intended for operational use at these extremes. This will prevent situations where explosive or other dangerous materiel that is developed for less than worldwide deployments is transported, stored, or used inadvertently in areas of unexpected extreme conditions thus possibly resulting in critical or catastrophic failure.

MIL-STD-810H
PART ONE ANNEX C

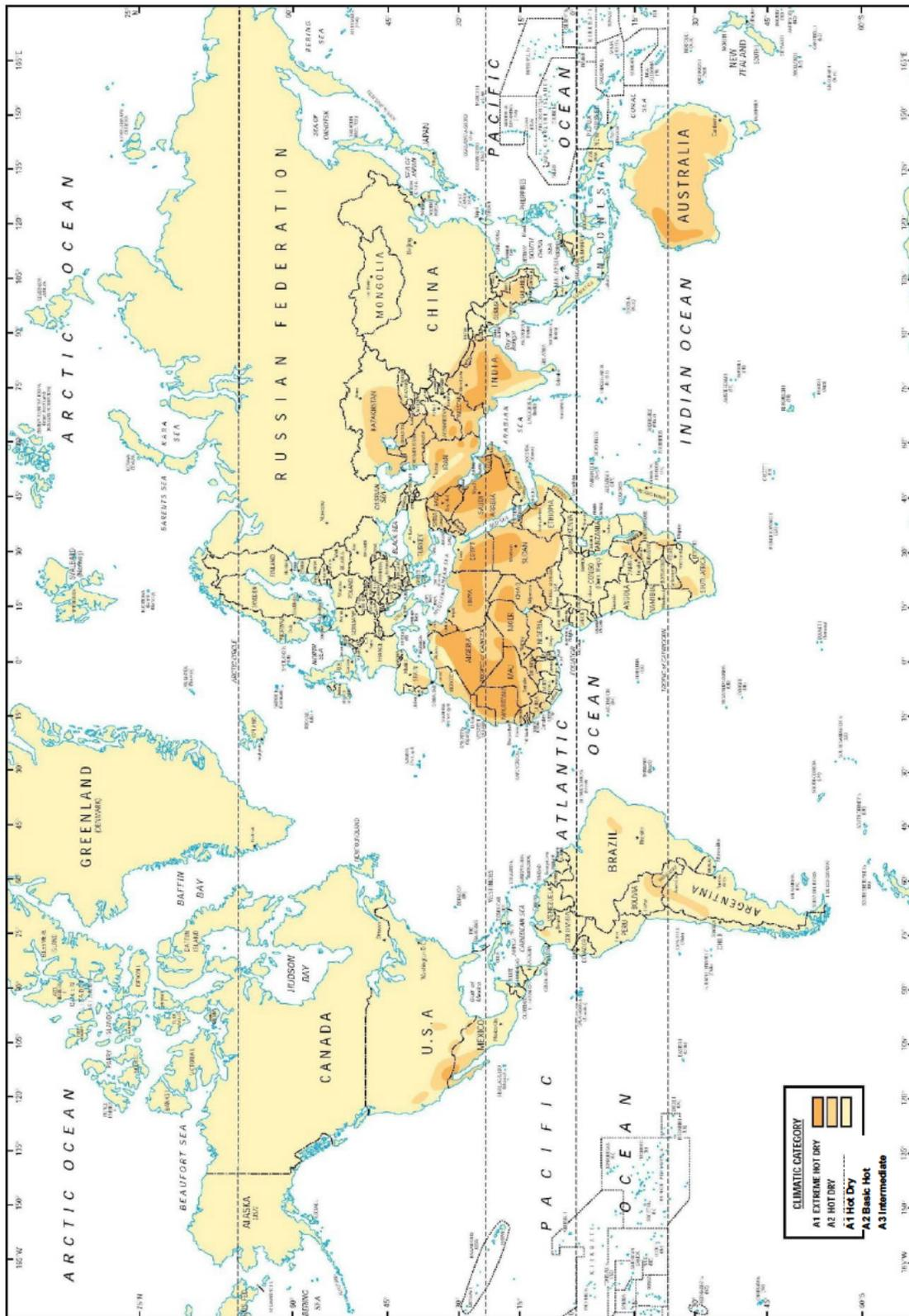


Figure C-1. Areas of occurrence of climatic categories A1, A2, & A3.

MIL-STD-810H
PART ONE ANNEX C

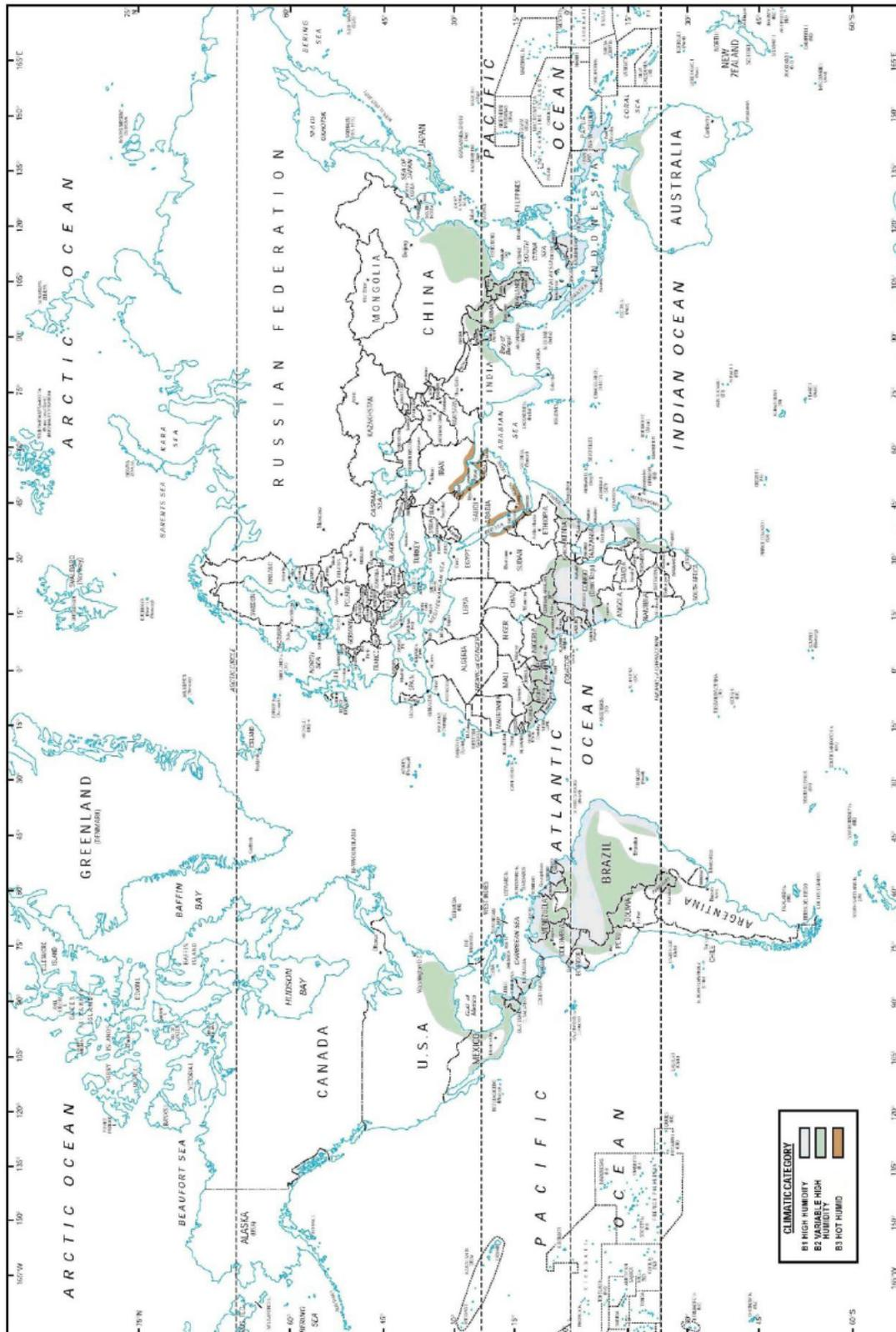


Figure C-2. Areas of occurrence of climatic categories B1, B2, & B3.

MIL-STD-810H
PART ONE ANNEX C

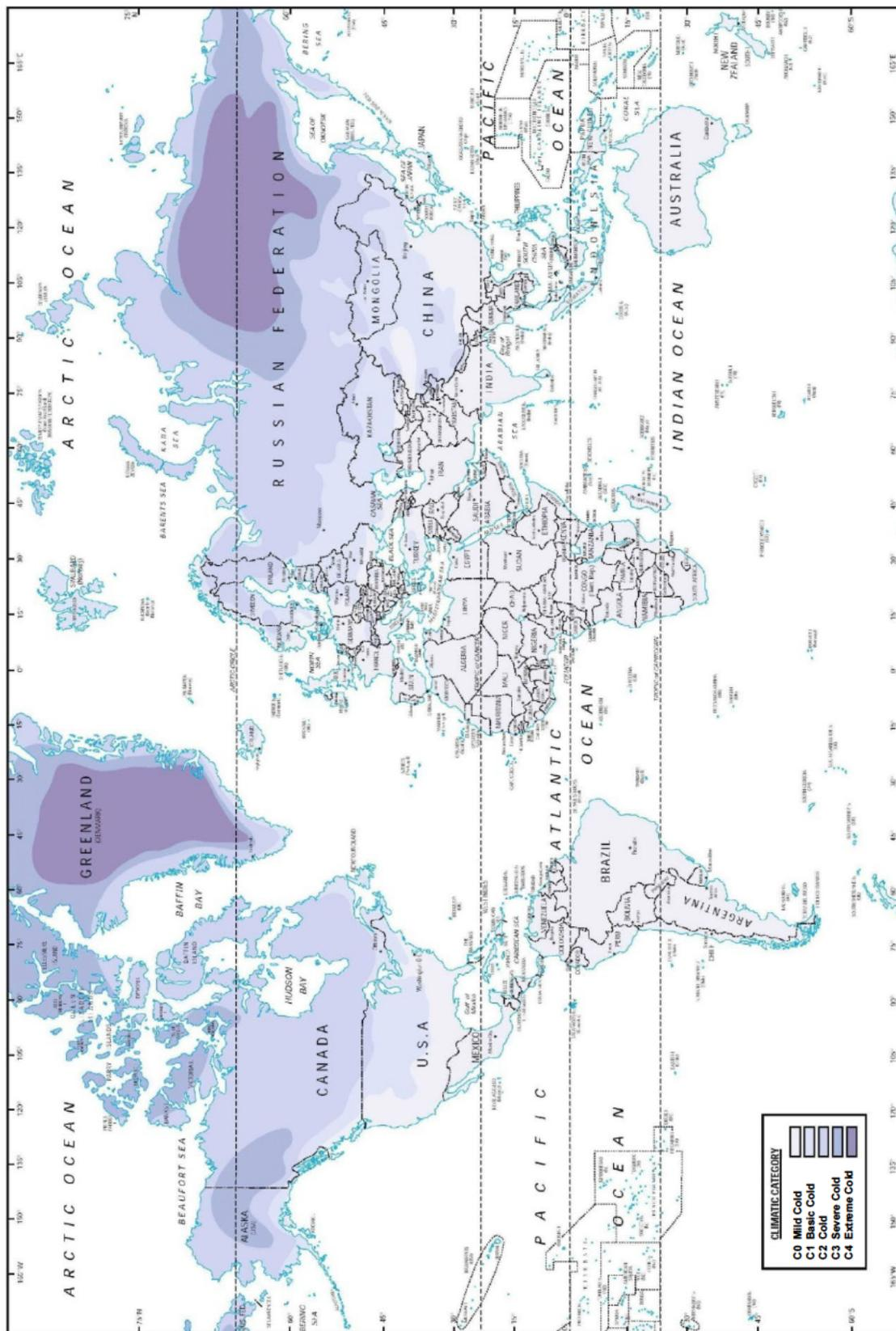


Figure C-3. Areas of occurrence of climatic categories C1, C2, & C3.

MIL-STD-810H
PART ONE ANNEX C

Table C-I. Summary of climatic conditions and daily cycles of temperature, solar radiation, and relative humidity.

Climatic Design Type	Daily Cycle ¹	Operational Conditions				Storage and Transit Conditions			Natural Environment Exposure Testing ⁷ °C (°F)
		Ambient Air Temperature ² °C (°F)		Solar Radiation W/m ² (Bph ³)	Ambient Relative Humidity %RH ⁴	Induced Air Temperature °C (°F)		Induced Relative Humidity %RH	
		Daily Low	Daily High			Daily Low	Daily High		
Hot	Hot Dry (A1)	32 (90)	49 (120)	0 to 1120 (0 to 355)	8 to 3	33 (91)	71 (160)	7 to 1	32 to 49 (90 to 120)
	Hot Humid (B3)	31 (88)	41 (105)	0 to 1080 (0 to 343)	88 to 59	33 (91)	71 (160)	80 to 14	Coastal Desert
Basic	Basic Hot (A2)	30 (86)	43 (110)	0 to 1120 (0 to 355)	44 to 14	30 (86)	63 (145)	44 to 5	0 to 43 (32 to 110)
	Intermediate ⁶ (A3)	28 (82)	39 (102)	0 to 1020 (0 to 323)	78 to 43	28 (82)	58 (136)	See note ⁵	
	Variable High Humidity (B2)	26 (78)	35 (95)	0 to 970 (0 to 307)	100 to 74	30 (86)	63 (145)	75 to 19	Humid Tropics
	Constant High Humidity (B1)	Nearly Constant 24 (75)		Negligible	95 to 100	Nearly Constant 27 (80)		95 to 100	
	Mild Cold ⁶ (C0)	-19 (-2)	-6 (21)	Negligible	Tending toward saturation	-21 (-6)	-10 (14)	Tending toward saturation	0 to -32 (32 to -25)
	Basic Cold (C1)	-32 (-25)	-21 (-5)	Negligible	Tending toward saturation	-33 (-28)	-25 (-13)	Tending toward saturation	
Cold	Cold (C2)	-46 (-50)	-37 (-35)	Negligible	Tending toward saturation	-46 (-50)	-37 (-35)	Tending toward saturation	-32 to -46 (-26 to -50)
Severe Cold	Severe Cold (C3)	-51 (-60)		Negligible	Tending toward saturation	-51 (-60)		Tending toward saturation	< -46 (< -50)
Extreme Cold	Extreme Cold ⁶ (C4)	-57 (-70)		Negligible	Tending toward saturation	-57 (-70)		Tending toward saturation	

¹ Designations in parentheses refer to corresponding climatic categories in MIL-HDBK-310 and AR-70-38 (except the A-3 category) and NATO STANAG 4370, AECTP 230; (see Part One, 2.2.1, 2.2.2, and 2.3).

² °C values (rounded to the nearest whole degree) derived from data obtained/established on °F scale.

³ Bph represents British Thermal Units per square foot per hour.

⁴ Sequence of RH presentation corresponds to sequence of air temperatures shown (e.g., for HOT-DRY daily cycle, 8 percent RH occurs at 32°C (90°F); 3 percent RH occurs at 49°C (120°F).

⁵ Relative humidity for the A3 storage condition vary to widely between different situations to be represented by a single set of conditions.

⁶ Values are only found in NATO STANAG 4370, AECTP 230.

⁷ Delineation to be used for natural environment exposure testing, not applicable to laboratory testing.

NOTE: The numbers shown for the values of the climatic elements represent only the upper and lower limits of the cycles that typify days during which the extremes occur; e.g., for the Hot-Dry cycle, 49°C (120°F) is the maximum daytime temperature, and 32°C (90°F) is the minimum nighttime (or early morning) temperature.

MIL-STD-810H
PART ONE ANNEX C

Table C-II. Summary of potential environments for the STORAGE PHASE.

SITUATIONS	NATURAL	INDUCED
a. <u>Depot</u>	Controlled or known temperature and humidity	Shock due to handling and drop Vibration due to handling Conducted EM interference due to testing Nuclear effects
b. <u>Sheltered</u>	High temperature (Dry/Humid) Low temperature Freeze/thaw Salt mist Chemical attack Fungal growth Diurnal (cycling temperature)	Shock due to handling Vibration due to handling Conducted EM interference due to testing Susceptibility to EM radiation Nuclear effects Free fall drop
c. <u>Open</u>	High temperature (Dry/Humid) Low temperature Freeze/thaw Sand and dust Salt mist Solar radiation Chemical attack Fungal growth Rain, hail, snow, ice Diurnal (cycling temperature)	Shock due to handling Vibration due to handling Conducted EM interference due to testing Susceptibility to EM radiation Electrostatic discharge (handling) Lightning Nuclear effects Free fall drop

Table C-III. Summary of potential environments for the TRANSPORTATION PHASE.

SITUATIONS	NATURAL	INDUCED
a. <u>Road</u>	High temperature (Dry/Humid) Low temperature Rain, hail, snow, ice Sand and dust Solar radiation Immersion/Fording	Shock due to road surface and handling Vibration due to road surface and engine Susceptibility to EM radiation Lightning Electrostatic discharge (handling) Free fall drop
b. <u>Rail</u>	High temperature (Dry/Humid) Low temperature Rain, hail, snow, ice Sand and dust Solar radiation	Shock due to rail transport and handling Vibration due to rails Free fall drop
c. <u>Air</u>	High temperature (Dry/Humid) Low temperature Reduced pressure Rapid pressure change Sand and dust Solar radiation Rain, hail, snow, ice	Shock due to landing and handling Vibration due to engines and airflow Free fall drop

MIL-STD-810H
PART ONE ANNEX C

Table C-III (Con't). Summary of potential environments for the TRANSPORTATION PHASE.

SITUATIONS	NATURAL	INDUCED
d. <u>Sea</u>	High temperature (Dry/Humid)	Shock due to wave motion, underwater weapon detonation, and handling
	Low temperature	Vibration due to wave motion and engine
	Rain, hail, snow, ice	Free fall drop
	Salt mist	
	Sand and dust	
	Solar radiation	
	Temporary immersion	
	Fungal growth	

Table C-IV. Summary of potential environments for the DEPLOYMENT PHASE

SITUATIONS	NATURAL	INDUCED
a. <u>Man Carried</u>	High temperature (Dry/Humid)	Shock due to weapon firing and handling
	Low temperature	Acoustic noise
	Freeze/thaw	Nuclear effects
	Rain, hail, snow, ice	EM interference
	Sand, dust, and mud	Electrostatic discharge
	Salt mist	Chemical and biological attack
	Solar radiation	Corrosive atmosphere
	Fungal growth	Free fall drop
	Chemical attack	Immersion
b. <u>Tracked & Wheeled Vehicle</u>	High temperature (Dry/Humid)	Shock due to road surface, weapon firing, detonation, and handling
	Low temperature	Vibration due to road surface and engine
	Freeze/thaw	High temperature due to glassed enclosure
	Rain, hail, snow, ice	Acoustic noise
	Sand, dust, and mud	Nuclear effects
	Salt mist	EM interference
	Solar radiation	Electrostatic discharge
	Fungal growth	Lightning
	Chemical attack	Chemical and biological attack
	Temperature shock	Corrosive atmosphere
	Immersion/Fording	Free fall drop
c. <u>Fixed Wing & Rotary Aircraft</u>	High temperature (Dry/Humid)	Shock due to assisted take-off, landing, and weapon blast
	Low temperature	Vibration due to runway surface, air maneuver, gunfire, aerodynamics, blade tones, engine, and air turbulence
	Freeze/thaw	Aerodynamic heating
	Rain	Nuclear effects
	Sand and dust	EM interference
	Salt mist	Electrostatic discharge
	Solar radiation	Lightning
	Rain and dust erosion	Corrosive atmosphere

MIL-STD-810H
PART ONE ANNEX C

Table C-IV (Con't). Summary of potential environments for the DEPLOYMENT PHASE

SITUATIONS	NATURAL	INDUCED
c. <u>Fixed Wing & Rotary Aircraft (Con't)</u>	Fungal growth Chemical attack Bird strike Low pressure Hail Rapid temp/humidity change Rapid pressure change Icing	Noise Free fall drop Contamination by fluids
d. <u>Ship & Submarine</u>	High temperature (Dry/Humid) Low temperature Freeze/thaw Rain, hail, snow, ice Salt mist Solar radiation Fungal growth Chemical attack	Shock due to weapon firing, detonation, and wave slam Vibration due to waves, engine, acoustic noise Nuclear effects EM interference Electrostatic discharge Lightning Corrosive atmosphere Increased pressure (submarine) Underwater detonation Free fall drop
e. <u>Stationary Equipment</u>	High temperature (Dry/Humid) Low temperature Freeze/thaw Rain, hail, snow, ice Salt mist Solar radiation Fungal growth Chemical attack	Shock due to weapon firing and detonation Vibration due to engines and mechanical movement Acoustic noise Nuclear effects EM interference Electrostatic discharge Lightning Corrosive atmosphere
f. <u>Projectile Free Flight</u>	Rain and dust erosion Wind	Shock due to firing and target impact Acceleration due to firing Aerodynamic heating Acoustic noise Nuclear effects EM interference Electrostatic discharge Lightning
g. <u>Torpedo Launch</u>	Immersion Thermal shock Pressure	Shock due to launch boost separation and target impact Vibration due to engine and hydrodynamic and aerodynamic turbulence Launch acceleration Acoustic noise

MIL-STD-810H
PART ONE ANNEX C

Table C-IV (Con't). Summary of potential environments for the DEPLOYMENT PHASE

SITUATIONS	NATURAL	INDUCED
g. <u>Torpedo Launch (Con't)</u>		Nuclear effects EM interference
h. <u>Missile Free Flight</u>	Rain and dust erosion	Shock due to launch, boost separation and target impact Vibration due to engine and aerodynamic turbulence Launch acceleration Acoustic noise Nuclear effects EM interference Electrostatic discharge Lightning Aerodynamic heating

MIL-STD-810H
PART ONE ANNEX D

PART ONE ANNEX D¹

TERMINOLOGY FOR DYNAMIC (MECHANICAL) TEST METHODS

- a. **AC-coupling.** In signal processing, this term implies the removal of any zero frequency information from the time history trace. In digitizing a signal, the analog-to-digital converter is said to be AC-coupled, if there exists a high pass filter in the digitizing process. Typically, piezoelectric devices are AC-coupled because of their inability to respond to static voltages.
- b. **Autocorrelation function.** For $x(t)$, a function of time, the autocorrelation function, $R_{xx}(\tau)$, is defined to be the following average over an averaging time, T ,

$$R_{xx}(\tau) = \frac{1}{T} \int_0^T x(t)x(t+\tau)dt$$

If the average $R_{xx}(\tau)$ is also a function of time, t , ($R_{xx}(\tau, t)$) such that

$$R_{xx}(\tau, t) = \frac{1}{T} \int_0^T x(t+u)x(t+u+\tau)du$$

then, this is a form of nonstationary autocorrelation function.

- c. **Autospectral density function (also known as power spectral density function).** For a stationary (ergodic) random process $\{x(t)\}$ for which the finite Fourier transform of $x(t)$ is given by:

$$X(f, T) = \int_0^T x(t)e^{-j2\pi ft} dt \quad -\infty < f < \infty$$

the two-sided autospectral density of $x(t)$ is defined by:

$$S_{xx}(f) = \lim_{T \rightarrow \infty} \frac{1}{T} E \left[|X(f, T)|^2 \right] \quad -\infty < f < \infty$$

for E , the expected value operator. A one-sided estimate of the autospectral density function of $x(t)$ over n_d distinct records, each of length T , is given by the following average of finite Fourier transforms:

$$\hat{G}_{xx}(f) = \frac{2}{n_d T} \sum_{i=1}^{n_d} |X_i(f, T)|^2 \quad 0 \leq f < \infty$$

In processing, the distinct records of length T may be windowed in the time domain to reduce spectral leakage, and the processing may be “overlapped” to restore degrees of freedom lost in the windowing process. Other processing options include the estimate processing in the frequency domain convolving basic frequency domain estimates with a selected window function defined in the frequency domain.

- d. **Classical pulse.** A short duration transient time history defined by $p(t)$ for $0 \leq t \leq T < \infty$, having the form of a half-sine, a square wave, a triangular wave, a ramp with a terminal peak amplitude, a ramp with an initial peak amplitude, or a general trapezoid.
- e. **Combination control.** A form of vibration system control that combines response control and force limit control in order to ensure measured or specified test spectra levels are met without inputs that provide for substantial overttest or undertest. Combination control requirements arise as a result of impedance mismatches between measured in-service materiel configuration response and laboratory test materiel configuration response. Use of response control alone may result in severe overttest spectra levels or undertest spectra levels at various frequencies.

¹ In this Annex, the symbol “T” represents a finite time and is such that $0 < T < \infty$, and the symbol “F” represents a finite frequency and is such that $0 < F < \infty$ unless otherwise specified.

MIL-STD-810H
PART ONE ANNEX D

- f. **Cross-correlation function.** For $x(t)$ and $y(t)$ functions of time, the cross correlation function, $R_{xy}(\tau)$, is defined to be the following average over an averaging time, T :

$$R_{xy}(\tau) = \frac{1}{T} \int_0^T x(t)y(t + \tau)dt$$

If the average $R_{xy}(\tau)$ is also a function of time, t , ($R_{xy}(\tau, t)$) such that

$$R_{xy}(\tau, t) = \frac{1}{T} \int_0^T x(t + u)y(t + u + \tau)du$$

then, this is a form of nonstationary cross correlation function.

- g. **Cross-spectral density function.** For stationary (ergodic) random processes $\{x(t)\}$ and $\{y(t)\}$ for which finite Fourier transforms of $x(t)$ and $y(t)$ are respectively,

$$X(f, T) = \int_0^T x(t) e^{-j2\pi ft} dt \quad -\infty < f < \infty$$

$$Y(f, T) = \int_0^T y(t) e^{-j2\pi ft} dt \quad -\infty < f < \infty$$

the two-sided cross-spectral density function of $x(t)$ and $y(t)$ is defined by:

$$S_{xy}(f) = \lim_{T \rightarrow \infty} \frac{1}{T} E \left\{ \left| X^*(f, T) Y(f, T) \right| \right\} \quad -\infty < f < \infty$$

An estimate of the one-sided cross-spectral density function of $x(t)$ and $y(t)$ over n_d distinct records, each of length T , is given by the following average of finite Fourier transforms:

$$\hat{G}_{xy}(f) = \frac{2}{n_d T} \sum_{i=1}^{n_d} X_i^*(f, T) Y_i(f, T) \quad 0 \leq f < \infty$$

In processing, the distinct records of length “ T ” may be windowed in the time domain to reduce spectral leakage, and the processing may be “overlapped” to restore degrees of freedom lost in the windowing process. Other processing options include the estimate processing in the frequency domain convolving basic frequency domain estimates with a selected window function defined in the frequency domain.

- h. **Decibel (dB).** The decibel (one tenth of a bel) is the logarithm of a ratio of two values. Generally the value in the denominator is termed the reference value. The reference value represents the power or amplitude level to which the decibel computation is referenced and must accompany any plot with an axis labeled decibels. For power quantities (e.g. noise, pressure, PSD, etc) it is given by:

$$dB = 10 \log_{10} (P_1/P_0) \quad \text{for reference power level } P_0$$

For linear quantities (e.g. acceleration, velocity, etc) it is given by:

$$dB = 20 \log_{10} (L_1/L_0) \quad \text{for reference linear level } L_0$$

- i. **DC-coupling.** In signal processing, this term implies the retention of all zero frequency information in a time history trace. In digitizing a signal, the analog-to-digital converter is said to be DC-coupled if there is no high pass filter in the digitizing process. Typically, piezoresistive devices are DC-coupled because of their ability to retain the magnitude of static voltages.

- j. **Energy autospectral density function.** For a time limited history $x(t)$ defined for $0 \leq t \leq T < \infty$ with finite Fourier transform

$$X(f, T) = \int_0^T x(t) e^{-j2\pi ft} dt \quad -\infty < f < \infty$$

the two-sided energy autospectral density function of $x(t)$ is given by:

$$L_{xx}(f, T) = E \left[\left| X(f, T) \right|^2 \right] \quad -\infty < f < \infty$$

MIL-STD-810H
PART ONE ANNEX D

for E, an ensemble average over n_d available single records. A one-sided estimate of this function is given by:

$$\hat{L}_{xx}(f, T) = 2|X(f, T)|^2 \quad 0 \leq f < \infty$$

To reduce the variance in the estimate $\hat{L}_{xx}(f, T)$, a direct average of n_d independent “equivalent” time limited events, $x(t)$, may be computed. The events generally will be replications of a given experiment, and will be considered as a time history ensemble. In processing, $x(t)$ will not be windowed in the time domain, but include all significant energy in the experiment.

- k. **Energy cross-spectral density function.** For time and band limited time histories $x(t)$ and $y(t)$ defined for $0 \leq t \leq T < \infty$ with finite Fourier transforms.

$$X(f, T) = \int_0^T x(t) e^{-j2\pi ft} dt \quad -\infty < f < \infty$$

$$Y(f, T) = \int_0^T y(t) e^{-j2\pi ft} dt \quad -\infty < f < \infty$$

the two-sided energy cross-spectral density function of $x(t)$ and $y(t)$ is given by:

$$L_{xy}(f, T) = E \left\{ \left| X^*(f, T) Y(f, T) \right| \right\} \quad -\infty < f < \infty$$

for E, an ensemble average over n_d available single records. A one-sided estimate of this function is given by:

$$\hat{L}_{xy}(f, T) = 2 \left| X^*(f, T) Y(f, T) \right| \quad 0 \leq f < \infty$$

To reduce the variance in the estimate $\hat{L}_{xy}(f, T)$, a direct average of n_d independent “equivalent” time limited events, $x(t)$, $y(t)$, may be computed. The events generally will be replications of a given experiment, and will be considered as a time history ensemble. In processing, neither $x(t)$, $y(t)$ will be windowed in the time domain.

- l. **Energy frequency response function.** For time limited histories $x(t)$ and $y(t)$ defined for $0 \leq t \leq T < \infty$ with energy cross-spectral density function $L_{xy}(f, T)$ and energy autospectral density function $L_{xx}(f, T)$, the energy frequency response function is defined as:

$$H_{xy}(f, T) = \frac{L_{xy}(f, T)}{L_{xx}(f, T)} \quad -\infty < f < \infty$$

A one-sided estimate of this function is given by:

$$\hat{H}_{xy}(f, T) = \frac{\hat{L}_{xy}(f, T)}{\hat{L}_{xx}(f, T)} \quad 0 \leq f < \infty$$

where $\hat{L}_{xy}(f, T)$ and $\hat{L}_{xx}(f, T)$ may represent averages over a given ensemble of n_d independent equivalent time limited events, $x(t)$ and $y(t)$. Averaging may reduce the variance in the estimate $\hat{H}_{xy}(f, T)$ that is taken as the quotient of two stable averages $\hat{L}_{xy}(f, T)$ and $\hat{L}_{xx}(f, T)$.

Note: The term “frequency response function” is used here preserving the term “transfer function” for the Laplace transform of the unit impulse response function.

- m. **Ensemble.** A collection of sample time history records from a single random process where each of the time history records is defined over the same duration time interval. The notation for an ensemble

MIL-STD-810H
PART ONE ANNEX D

representing a random process $x(t)$ is $\{x(t)\}$. If the ensemble has N members over time $0 \leq t \leq T < \infty$, the notation is $\{x_i(t) : 0 \leq t \leq T, i = 1, 2, \dots, N\}$.

- n. **Ergodic (nonergodic) process.** A random process that may be represented by an ensemble of time history records for which the time averaged parameters of any one time history record from the ensemble is representative of the time averaged parameters of the ensemble of time history records. An ergodic random process is a stationary random process. A random process that does not satisfy the above definition is termed nonergodic. Procedures for the determination of nonergodicity of a random process may take a number of forms. A stationary process may be also ergodic, whereas an ergodic process is always stationary.
- o. **Filter.** Fourier spectrum transformation of a given input time history, $x(t)$, in order to produce a desired effect. Such filtering may be through band limiting the time history spectra through lowpass, highpass, bandpass, or bandstop forms of filtering. Filtering may be performed equivalently in either the time domain or the frequency domain. If the filtering transformation preserves the phase relationships between the input and output frequency components, the filter is referred to as a linear phase filter. If the filtering transformation distorts the phase relationships between input and output frequency components, the filter is referred to as a nonlinear phase filter. Further terminology related to filtering is provided in Method 516.5 and Method 517.
- p. **Force limit control.** A form of vibration system control that attempts to limit the input interface test levels to those levels measured or specified at the interface. In general, the levels measured or specified at the interface are in terms of force input to the test item interface or the test item interface mount.
- q. **Fourier transform and finite Fourier transform.** For a time history, $x(t)$, defined for $-\infty < t < \infty$, the Fourier transform of $x(t)$ is defined as a complex-valued function of frequency, f , when the integral exists. $X(f)$ is termed the direct Fourier transform of $x(t)$ and $x(t)$ is termed the inverse Fourier transform of $X(f)$.

$$X(f) = \int_{-\infty}^{\infty} x(t) e^{-j2\pi ft} dt \quad -\infty < t < \infty$$

For a time history $x(t)$, defined for $0 \leq t \leq T < \infty$, the finite Fourier transform of $x(t)$ is defined as a complex-valued function of frequency f .

$$X(f, T) = \int_0^T x(t) e^{-j2\pi ft} dt \quad -\infty < t < \infty$$

$X(f, T)$ is termed the direct finite Fourier transform of $x(t)$; and $x(t)$ is termed the inverse finite Fourier transform of $X(f, T)$. The finite Fourier transform always exists for well defined $x(t)$, $0 \leq t \leq T < \infty$. ($X^*(f, T)$ represents the complex conjugate of $X(f, T)$.)

- r. **Gaussian (non-Gaussian) process.** For $x(t)$, a stationary random process that obeys the following probability density function at any time t for μ_x and σ_x constants:

$$p(x) = (\sigma_x \sqrt{2\pi})^{-1} \exp \left[-\frac{(x - \mu_x)^2}{2\sigma_x^2} \right] \quad -\infty < x < \infty$$

then $x(t)$ will be considered to be a Gaussian stationary random process. Conversely, for $x(t)$ a random process that does not obey the probability density function at some time, t , will be considered to be non-Gaussian. This definition is not restricted to ergodic random processes.

- s. **Inverse Fourier transform and inverse finite Fourier transform.** For the Fourier transform $X(f)$, defined for $-\infty < f < \infty$, the inverse Fourier transform of $X(f)$ is defined as a real valued function of time, t :

$$x(t) = \frac{1}{2\pi} \int_{-\infty}^{\infty} X(f) e^{j2\pi ft} df \quad -\infty < t < \infty$$

when the integral exists. $x(t)$ is termed the inverse Fourier transform of $X(f)$, and $X(f)$ is termed the Fourier transform of $x(t)$.

MIL-STD-810H
PART ONE ANNEX D

For the finite Fourier transform $X(f, T)$ defined over a frequency band of $-F \leq f \leq F$, the inverse finite Fourier transform of $X(f, T)$ is defined as a real-valued function of time, t :

$$x(t) = \frac{1}{2\pi} \int_{-F}^F X(f, T) e^{j2\pi ft} df \quad -\infty < t < \infty$$

$x(t)$ is termed the inverse finite Fourier transform of $X(f, T)$ and $X(f, T)$ is termed the finite Fourier transform of $x(t)$, $0 \leq t \leq T < \infty$. The inverse finite Fourier transform always exists for well defined $X(f, T)$, $-F < f < F$ and is periodic in t .

- t. **Linear system.** A system in which scaled and additive inputs result in scaled and additive outputs. That is, for $y = h(x)$ representation of a linear system, h , then for c , a constant, and x, x_1, x_2 inputs the following input/output relationships are defined:

System homogeneity: $cy = ch(x) = h(cx)$

System superposition: $y_1 + y_2 = h(x_1) + h(x_2) = h(x_1 + x_2)$

- u. **Mean (ensemble).** For an ensemble $\{x_i(t): 0 \leq t \leq T < \infty, i = 1, 2, \dots, N\}$ of N time history records, $x_i(t)$, with a mean $\mu(t)$, $0 \leq t \leq T$, an unbiased estimate of the mean of the ensemble at time t is given by:

$$\hat{m}(t) = \frac{1}{N} \sum_{i=1}^N x_i(t) \quad 0 \leq t \leq T$$

$\mu(t)$ is the first moment of the random process $\{x(t)\}$.

- v. **Mean-square (ensemble).** For an ensemble $\{x_i(t): 0 \leq t \leq T < \infty, i = 1, 2, \dots, N\}$ of N time history records with a mean square $p(t)$, $0 \leq t \leq T$, an unbiased estimate of the mean-square for the ensemble at time t is given by:

$$\hat{p}(t) = \frac{1}{N} \sum_{i=1}^N x_i^2(t)$$

$p(t)$ is the second moment of the random process $\{x(t)\}$.

- w. **Nonlinear system.** A system that is not linear in that either the system homogeneity requirement or the system superposition requirement or both are violated. For $y = h(x)$ representation of system h , then for c , a constant, and x_1, x_2 inputs, either

$$cy = ch(x) \neq h(cx)$$

or

$$y_1 + y_2 = h(x_1) + h(x_2) \neq h(x_1 + x_2)$$

or both.

- x. **Non-stationary process.** A nonstationary random process is an ensemble of time history records that cannot be defined to be stationary. In general, the statistical properties of a nonstationary process are a function of time and not invariant with respect to time translations. In this Standard, if either the mean (first moment) estimate or mean-square (second moment) estimate, or both from a random process ensemble vary with time over the ensemble, the random process is considered nonstationary. If the ensemble has a deterministic component that varies in time, the ensemble may or may not be considered nonstationary depending on whether the random part of the ensemble is nonstationary or stationary.
- y. **Power spectral density function.** See "autospectral density function", in subparagraph "c.", above.
- z. **Pulse.** For purpose of this Standard, a pulse is a finite duration deterministic or random time history. In cases in which the pulse is related to the response in testing of materiel, the duration is generally no longer than five times the period of the lowest natural frequency of the materiel under consideration, and may be substantially shorter.
- aa. **Random process.** A random process is represented by an ensemble of time history records that have properties described in terms of parameters estimated from statistical computations at selected times. In this standard it will be assumed that one or more sample records from the random process are related to a repeatable experiment that completely describes the phenomenon under consideration.

MIL-STD-810H
PART ONE ANNEX D

- bb. **Response control.** A form of vibration system control that attempts to match the response of materiel at one or more points with measured or specified vibration data at one or more points on the materiel. Vibration control system operational procedures provide for a variety of response matching options, e.g., single point control, multipoint control, average control, extreme control, etc.
- cc. **Root-mean-square (ensemble).** For an ensemble $\{x_i(t): 0 \leq t \leq T < \infty, i = 1, 2, \dots, N\}$ of N time history records with a mean square $p(t)$, $0 \leq t \leq T$, (estimated by $\hat{p}(t)$), an estimate of the root-mean-square for the ensemble at time t is given by:

$$\hat{r}(t) = \sqrt{\hat{p}(t)} = \sqrt{\frac{1}{N} \sum_{i=1}^N x_i^2(t)}$$

- dd. **Sample function.** One particular realization of a random process that may be used to form an ensemble representation for the random process.
- ee. **Single degree of freedom (SDOF).** A single degree-of-freedom system is one for which only one coordinate is required to define completely the configuration of the system at any instant.
- ff. **Spectrum.** The representation of a time history in terms of a function of frequency. The representation, in general, will occur as a result of analyzing the time history with the Fourier transform and may be real or complex. (In the case of time history data analyzed by way of the shock response spectrum engineering tool, the representation is in terms of real amplitude and the natural frequency of a single degree of freedom system.)
- gg. **Standard deviation (ensemble).** For an ensemble $\{x_i(t): 0 \leq t \leq T < \infty, i = 1, 2, \dots, N\}$ of N time history records with a mean, $\mu(t)$, and a standard deviation, $\sigma(t)$, $0 \leq t \leq T$, where the mean $\mu(t)$ is estimated by $\hat{m}(t)$, an unbiased estimate of the standard deviation of the ensemble at time t is given by:

$$\hat{s}(t) = \sqrt{\frac{1}{N-1} \sum_{i=1}^N (x_i(t) - \hat{m}(t))^2} \quad 0 \leq t \leq T$$

- hh. **Stationary process.** A stationary random process is an ensemble of time history records that has statistical properties that are not a function of time and, hence, are invariant with respect to time translations. The stationary random process may be ergodic or nonergodic.
- ii. **Statistical degrees of freedom (Statistical DOF).** The number of values in the final calculation of a statistic that are free to vary. The number of degrees-of-freedom determines the statistical confidence of an estimate. When time-averaging is used in the analysis of the variance of random data, the effective number of statistical degrees of freedom is $n = 2BT$, where B is the effective filter bandwidth (analysis bandwidth) and T is the overall effective averaging time. For exponential spectral averaging it can be demonstrated that $n = 2n_d(2k - 1)$, where n_d = the number of distinct data blocks in the linear average and k = the number of distinct data blocks in the exponential average. Setting $k=1$ implies linear spectral averaging yielding $n = 2n_d$.

MIL-STD-810H
PART ONE ANNEX D

- jj. **Transient vibration.** A form of nonstationary random vibration time history that has a positive time-varying envelope that begins at zero and ends at zero over a certain period of time, $T < \infty$. In general, for $a(t)$, $0 \leq t \leq T$, the time-varying deterministic envelope function with frequency content below significant frequency content in the stationary random vibration time history, $x(t)$, the transient vibration may be modeled in terms of the product model

$$y(t) = a(t)x(t) \quad 0 \leq t \leq T$$

A condition for application of this model to random data is

$$|A(f, T)| \ll |X(f, T)| \quad f_0 < f$$

for some f_0 and $f_0 < f$ where $f_0 \approx \frac{1}{T}$. This condition helps ensure $a(t)$ does not significantly modulate $x(t)$.

- kk. **Variance (ensemble).** For an ensemble $\{x_i(t): 0 \leq t \leq T < \infty, i = 1, 2, \dots, N\}$ of N time history records with a mean $\mu(t)$ and a variance $\sigma^2(t)$, $0 \leq t \leq T$, where $\mu(t)$ is estimated by $\hat{m}(t)$, an unbiased estimate of the variance of the ensemble at time t is given by:

$$\hat{v}(t) = \frac{1}{N-1} \sum_{i=1}^N (x_i(t) - \hat{m}(t))^2 \quad 0 \leq t \leq T$$

- ll. **Waveform control.** A form of vibration system control in which the system replicates a properly compensated time history, $x(t)$, in an open loop (no feedback) mode of control. In this Standard, waveform control will refer to the replication of measured materiel response in laboratory testing based upon determining the input voltage time history to the vibration control system that will nearly exactly reproduce the measured materiel response when applied to the vibration system.

MIL-STD-810H
PART ONE ANNEX D

(This page is intentionally blank.)

MIL-STD-810H
PART TWO**PART TWO -- LABORATORY TEST METHODS****TABLE OF CONTENTS**

No.	Title	Pages	No. of pages
500	Low Pressure (Altitude)	500.6-i – 500.6-8	10
501	High Temperature	501.7-i – 501.7-14	16
502	Low Temperature	502.7-i – 502.7-10	12
503	Temperature Shock	503.7-i – 503.7-14	16
504	Contamination by Fluids	504.3-i – 504.3C-2	20
505	Solar Radiation (Sunshine)	505.7-i – 505.7C-8	36
506	Rain	506.6-i – 506.6-14	16
507	Humidity	507.6-i – 507.6A-2	24
508	Fungus	508.8-i – 508.8B-2	20
509	Salt Fog	509.7-i – 509.7-10	12
510	Sand and Dust	510.7-i – 510.7-14	16
511	Explosive Atmosphere	511.7-i – 511.7-10	12
512	Immersion	512.6-i – 512.6-8	10
513	Acceleration	513.8-i – 513.8A-8	24
514	Vibration	514.8-i – 514.8F-F2	180
515	Acoustic Noise	515.8-i – 515.8B-4	26
516	Shock	516.8-i – 516.8B-8	79
517	Pyroshock	517.3-i – 517.3A-10	44
518	Acidic Atmosphere	518.2-1 – 518.2-8	10
519	Gunfire Shock	519.8-i – 519.8E-8	86
520	Temperature, Humidity, Vibration, and Altitude	520.5-i – 520.5-24	26
521	Icing/Freezing Rain	521.4-i – 521.4-8	10
522	Ballistic Shock	522.2-i – 522.2-20	22
523	Vibro-Acoustic/Temperature	523.4-i – 523.4A-8	30
524	Freeze-Thaw	524.1-i – 524.1-6	8
525	Time Waveform Replication	525.2-i – 525.2B-10	58
526	Rail Impact	526.2-i – 526.2-10	12
527	Multi-Exciter Testing	527.2-i – 527.2E-38	80
528	Mechanical Vibrations Of Shipboard Materiel (Type I – Environmental And Type II – Internally Excited)	528.1-i – 528.1B-4	32
Part One	Environmental Engineering Program Guidelines	PART ONE-i – PART ONE D-8	80
Part Two	Laboratory Test Methods	PART TWO-1 – 528.1B-4	949
Part Three	World Climatic Regions – Guidance	PART THREE-i – PART THREE C-2	57

MIL-STD-810H
PART TWO

(This page is intentionally blank.)

MIL-STD-810H
METHOD 500.6

METHOD 500.6
LOW PRESSURE (ALTITUDE)
CONTENTS

1.	SCOPE	1
1.1	PURPOSE	1
1.2	APPLICATION	1
1.3	LIMITATIONS	1
2.	TAILORING GUIDANCE	1
2.1	SELECTING THE LOW PRESSURE (ALTITUDE) METHOD	1
2.1.1	EFFECTS OF LOW PRESSURE ENVIRONMENTS	1
2.1.1.1	PHYSICAL/CHEMICAL	1
2.1.1.2	ELECTRICAL	2
2.1.2	SEQUENCE AMONG OTHER METHODS	2
2.2	SELECTING PROCEDURES	2
2.2.1	PROCEDURE SELECTION CONSIDERATIONS	2
2.2.2	DIFFERENCE AMONG PROCEDURES	2
2.3	DETERMINE TEST LEVELS AND CONDITIONS	3
2.3.1	TEST PRESSURE (ALTITUDE) AND TEMPERATURE	3
2.3.2	ALTITUDE CHANGE RATE	4
2.3.3	DECOMPRESSION RATE	4
2.3.4	TEST DURATION	4
2.3.5	TEST ITEM CONFIGURATION	4
2.3.6	HUMIDITY	4
3.	INFORMATION REQUIRED	4
3.1	PRETEST	4
3.2	DURING TEST	5
3.3	POST TEST	5
4.	TEST PROCESS	5
4.1	TEST FACILITY	5
4.2	CONTROLS	5
4.3	TEST INTERRUPTION	5
4.3.1	INTERRUPTION DUE TO CHAMBER MALFUNCTION	6
4.3.2	INTERRUPTION DUE TO TEST ITEM OPERATION FAILURE	6
4.4	TEST SETUP	6
4.5	TEST EXECUTION	6
4.5.1	PREPARATION FOR TEST	6
4.5.1.1	PRELIMINARY STEPS	6
4.5.1.2	PRETEST STANDARD AMBIENT CHECKOUT	6
4.5.2	PROCEDURE I – STORAGE / AIR TRANSPORT	6
4.5.3	PROCEDURE II – OPERATION / AIR CARRIAGE	7
4.5.4	PROCEDURE III – RAPID DECOMPRESSION	7
4.5.5	PROCEDURE IV – EXPLOSIVE DECOMPRESSION	7
5.	ANALYSIS OF RESULTS	8
6.	REFERENCE/RELATED DOCUMENTS	8
6.1	REFERENCED DOCUMENTS	8
6.2	RELATED DOCUMENTS	8

MIL-STD-810H
METHOD 500.6

(This page is intentionally blank.)

MIL-STD-810H
METHOD 500.6**METHOD 500.6****LOW PRESSURE (ALTITUDE)**

NOTE: Tailoring is essential. Select methods, procedures and parameter levels based on the tailoring process described in Part One, paragraph 4.2.2, and Annex C. Apply the general guidelines for laboratory test methods described in Part One, paragraph 5 of this standard.

1. SCOPE.**1.1 Purpose.**

Use low pressure (altitude) tests to determine if materiel can withstand and/or operate in a low pressure environment and/or withstand rapid pressure changes.

1.2 Application.

Use this method to evaluate materiel likely to be:

- a. stored and/or operated at high ground elevation sites.
- b. transported or operated in pressurized or unpressurized areas of aircraft (also consider Method 520.5 for actively-powered materiel operated at altitude).
- c. exposed to a rapid or explosive decompression and, if so, to determine if its failure will damage the aircraft or present a hazard to personnel.
- d. carried externally on aircraft.

1.3 Limitations.

This Method is not intended to be used to test materiel to be installed or operated in space vehicles, aircraft or missiles that fly at altitudes above 21,300 m (70,000 ft). Recommend the test be to the maximum altitude (minimum pressure) normally reached by the appropriate mode of transportation.

Procedure IV is not intended to be used for materiel transported in a cargo bay. For example, analysis for a C-5 aircraft indicates that to go from a cabin altitude of 2438 m (8,000 ft) to an ambient altitude of 12192m (40,000 ft) in 1 second would require a hole of approximately 33.4 m² (360 ft²). Instantaneous creation of a hole that large in the side of the airplane would be catastrophic to the airplane. Please note that the 33.4 m² (360 ft²) hole is for a 1-second depressurization. To depressurize in one tenth of a second would require a hole ten times as large.

2. TAILORING GUIDANCE.**2.1 Selecting the Low Pressure (Altitude) Method.**

After examining the requirements documents, and applying the tailoring process in Part One of this Standard to determine where low pressure is foreseen in the life cycle of the materiel, use the following to aid in selecting this Method and placing it in sequence with other methods. Based upon the LCEP, there may be a requirement to conduct this Method in combination with other Methods within this standard (i.e., high temperature, low temperature, or vibration).

2.1.1 Effects of Low Pressure Environments.

In addition to thermal effects (see Methods 501.7 and 502.7), consider the following typical problems to help determine if this Method is appropriate for the materiel being tested. This list is not intended to be all-inclusive and some of the examples may overlap the categories.

2.1.1.1 Physical/Chemical.

- a. Leakage of gases or fluids from gasket-sealed enclosures.
- b. Deformation, rupture or explosion of sealed containers.
- c. Change in physical and chemical properties of low-density materials.

MIL-STD-810H
METHOD 500.6

- d. Overheating of materiel due to reduced heat transfer.
- e. Evaporation of lubricants.
- f. Erratic starting and operation of engines.
- g. Failure of hermetic seals.

2.1.1.2 Electrical.

Erratic operation or malfunction of materiel resulting from arcing or corona.

2.1.2 Sequence among other methods.

- a. General. Use the anticipated life cycle sequence of events as a general sequence guide (see Part One, paragraph 5.5).
- b. Unique to this Method. Normally, this Method is performed early in a test sequence because of both its limited damage potential, and its generally early occurrence in the life cycle. However, other testing may contribute significantly to the effects of low pressure on the test item (see paragraph 2.1.1), and may have to be conducted before this Method. For example:
 - (1) Low temperature and high temperature testing may affect seals.
 - (2) Dynamic tests may affect the structural integrity of the test item.
 - (3) Aging of non-metallic components may reduce their strength.

2.2 Selecting Procedures.

This Method includes four low pressure tests: Procedure I (Storage); Procedure II (Operation); Procedure III (Rapid Decompression), and Procedure IV (Explosive Decompression). Based on the test data requirements, determine which of the test procedures or combination of procedures is applicable.

NOTE: For Procedure II, Method 520.5 may be used in addition to this Method when considering the potential synergistic and/or flight safety effects. However, Method 520 is NOT a substitute for Method 500.

2.2.1 Procedure selection considerations.

Differences among the low pressure test procedures are explained below. Select the procedure that represents the most severe exposure anticipated. When selecting a procedure, consider:

- a. The materiel configuration.
- b. The logistical and operational requirements (purpose) of the materiel.
- c. The operational purpose of the materiel.
- d. The test data required to determine if the operational purpose of the materiel has been met.
- e. Procedure sequence.
- f. Whether the cargo compartment is pressurized.

2.2.2 Difference among procedures.

- a. Procedure I - Storage/Air Transport. Procedure I is appropriate if the materiel is to be transported or stored at high ground elevations or transported by air in its shipping/storage configuration. Evaluate the materiel with respect to known effects of low pressure (paragraph 2.1.1) and the LCEP (Part One, paragraph 4.2.2.3.1) to determine if this procedure is appropriate.
- b. Procedure II - Operation/Air Carriage. Use Procedure II to determine the performance of the materiel under low pressure conditions. It may be preceded by Procedure I. If there are no low pressure storage, rapid, or explosive decompression requirements, this procedure can stand alone.

MIL-STD-810H
METHOD 500.6

- c. Procedure III - Rapid Decompression. Use Procedure III to determine if a rapid decrease in pressure of the surrounding environment will cause a materiel reaction that would endanger nearby personnel or the platform (ground vehicle or aircraft) in which it is being transported. This procedure may be preceded by Procedure I and/or Procedure II.
- d. Procedure IV - Explosive Decompression. (See paragraph 1.3.) Procedure IV is similar to Procedure III except that it involves an "instantaneous" decrease in the pressure of the surrounding environment. NOTE: This procedure is more appropriate for items such as sealed cockpit equipment whose failure could endanger cockpit personnel. Since one purpose of this test is to ensure failure of the materiel does not endanger personnel, and a catastrophic failure severe enough to cause an explosive decompression of the cargo compartment would, most likely, bring down the aircraft, carefully consider the appropriateness of application of this procedure for large cargo items. This procedure may be preceded by Procedure I and/or Procedure II.

NOTE: After either decompression test, a potential safety problem could exist that is not obvious. Exercise caution during the post-test operational check.

2.3 Determine Test Levels and Conditions.

Having selected this Method and relevant procedures (based on the materiel's requirements documents and the tailoring process), it is necessary to complete the tailoring process by selecting specific parameter levels and special test conditions/techniques for these procedures based on requirements documents and Life Cycle Environmental Profile (LCEP), (see Part One, Figure 1-1), and information provided with this procedure. From these sources of information, determine the functions to be performed by the materiel in low pressure environments or following storage in low pressure environments. Determine the test parameters such as test pressure and temperature, rate of change of pressure (and temperature if appropriate), duration of exposure, and test item configuration.

2.3.1 Test Pressure (Altitude) and Temperature.

Base determination of the specific test pressures (altitude) and temperatures on the anticipated deployment or flight profile of the test item. See Method 520.5, Table 520.5-2, for pressure versus altitude conversion equations.

- a. Ground areas. If measured data are not available, temperatures may be obtained for appropriate ground elevations and geographical locations from STANAG 4370, AECTP 230 (paragraph 6.1, reference b). The highest elevation currently contemplated for ground military operations (materiel operating and non-operating) is 4,572 m (15,000 ft), with an equivalent air pressure of 57.2 kPa (8.3 psia) (see paragraph 6.1, reference c).
- b. Transport aircraft cargo compartment pressure conditions. The test pressure used for each of the four procedures in this Method will vary greatly for each test item. Compartments normally pressurized may not be in certain situations. There are many different types of cargo transport aircraft on which materiel could be transported, and many different types of pressurization systems. Most pressurization systems provide outside atmospheric pressure in the cargo compartment (no pressure differential between the inside and outside of the aircraft) up to a particular altitude, and then maintain a specific pressure above that altitude. The pressure inside the cargo department is known as "cabin altitude." Subject the test item to the most likely anticipated conditions. Unless the materiel has been designed for transport on a particular aircraft with unique cabin altitude requirements, use the following guidance:
- (1) For Procedures I and II, unless otherwise identified, use 4,572 m (15,000 ft) for the cabin altitude (corresponding pressure in a standard atmosphere: 57.2 kPa or 8.3 psia).
 - (2) For Procedures III and IV, use 2,438m (8,000 ft) for the initial cabin altitude (75.2 kPa or 10.9 psia), and 12,192 m (40,000 ft) for the final cabin altitude after decompression (18.8 kPa or 2.73 psia).

NOTE: Cargo aircraft may transport cargo in either pressurized or un-pressurized conditions for various reasons including fuel economy

MIL-STD-810H
METHOD 500.6

- c. Transport aircraft cargo compartment temperature conditions. The range of temperatures associated with the various low pressure situations varies widely, primarily depending on the capabilities of the environmental control system within the cargo compartment of the various aircraft. Obtain the test temperatures from measured data or from appropriate national sources.
- d. Transport aircraft cargo compartment humidity conditions. The humidity exposure associated with the various low pressure situations will also vary widely. If humidity has been identified as an environment of concern in the LCEP, humidity levels should come from measured data or from appropriate national sources.

2.3.2 Altitude Change Rate.

If a specific rate of altitude change (climb/descent rate) is not known or specified in the requirements document, the following guidance is offered: In general, and with the exception of the explosive decompression test, do not use a rate of altitude change that exceeds 10 m/s (32.8 ft/sec.) unless justified by the anticipated deployment platform. In a full military power takeoff, military transport aircraft normally have an average altitude change rate of 7.6 m/s (25 ft/sec.). Use the value of 10 m/s (32.8 ft/sec.) for ground deployment tests (for standardization purposes) unless otherwise specified.

2.3.3 Decompression Rate.

There are several conditions for which the rapid rate of decompression may vary. These include:

- a. Sufficient damage to the aircraft cockpit or other critical small compartments causing virtually instantaneous decompression (explosive decompression -- to be accomplished in 0.1 second or less). This procedure is not intended to be used for materiel transported in the cargo bay.
- b. Relatively minor damage caused by foreign objects through which decompression could occur at a slower rate than above (rapid decompression -- not more than 15 seconds).

2.3.4 Test Duration.

For Procedure I, use a test duration representative of the anticipated service environment but, if this is extensive, use a test duration of at least one hour that has historically been considered adequate for most materiel. Once the test pressure has been reached and any required functions performed, Procedures II, III, and IV do not require extended periods at the test pressure. In some cases, there may be a need to tailor Procedure II to account for test item stabilization (see Part One, paragraph 5.4.1).

2.3.5 Test Item Configuration.

Determine the test item configuration based on the realistic configuration(s) of the materiel as anticipated for transportation, storage, or operation. As a minimum, consider the following configurations:

- a. In a shipping/storage container or transit case.
- b. In its normal operating configuration (realistic or with restraints, such as with openings that are normally covered).

2.3.6 Humidity.

Although various levels of humidity commonly exist in the natural environment, there is no requirement to include it in this Method because of the complexities involved in controlling combinations of temperature, air pressure, and relative humidity. However, this Method may be tailored to accommodate temperature and humidity if so identified in the LCEP as a non-operational environment of concern. Method 520.5 does include this combination for an operational environment and which requires the development of a tailored test profile. MIL-HDBK-310 (paragraph 6.1, reference a) includes data on humidity at altitude.

3. INFORMATION REQUIRED.

3.1 Pretest.

The following information is required to conduct the low pressure tests adequately.

- a. General. Information listed in Part One, paragraphs 5.7 and 5.9, and Annex A, Task 405 of this Standard.
- b. Specific to this Method.

MIL-STD-810H
METHOD 500.6

- (1) Test altitude and corresponding pressure.
 - (2) Altitude change rates (or pressurization schedule if a particular aircraft and flight environment are known).
 - (3) Test temperature and/or humidity (if controlled).
 - (4) Test item configuration.
 - (5) Test duration.
 - (6) Test item sensor location(s) if applicable
- c. Tailoring. Necessary variations in the basic test procedures to accommodate environments identified in the LCEP.

3.2 During Test.

Collect the following information during conduct of the test:

- a. See Part One, paragraph 5.10, and Annex A, Tasks 405 and 406 of this Standard.
- b. Record of the chamber pressure (altitude)-versus-time data for the duration of the test.
- c. Record of the chamber and test item temperature versus time conditions (if applicable).
- d. Record of the chamber humidity versus time conditions (if applicable).

3.3 Post Test.

The following post test data shall be included in the test report.

- a. General. Information listed in Part One, paragraph 5.13, and in Annex A, Task 406 of this Standard.
- b. Specific to this Method.
 - (1) Previous test methods to which the specific test item has been subjected.
 - (2) Time-versus pressure data.
 - (3) Any deviations from the original test plan.
 - (4) Time versus temperature and humidity (if applicable).

4. TEST PROCESS.**4.1 Test Facility.**

- a. The required apparatus consists of a chamber or cabinet together with auxiliary instrumentation capable of maintaining and monitoring (see Part One, paragraph 5.18) the required environmental condition(s).
- b. Record chamber pressure and, if required, temperature and/or humidity at a sufficient rate to capture data necessary for post-test analysis (see Part One, paragraph 5.18).

4.2 Controls.

For standardization purposes:

- a. Altitude change rate. Unless otherwise specified (as in the explosive decompression procedure), do not use an altitude change rate in excess of 10 m/s (32.8 ft/sec.). (See paragraph 2.3.2.)
- b. Charts. When using a chart recorder, ensure charts can be read with a resolution within two percent of full scale.

4.3 Test Interruption.

Test interruptions can result from two or more situations, one being from failure or malfunction of test chambers or associated test laboratory equipment. The second type of test interruption results from failure or malfunction of the test item itself during operational checks.

4.3.1 Interruption Due to Chamber Malfunction.

MIL-STD-810H
METHOD 500.6

- a. General. See Part One, paragraph 5.11, of this Standard.
- b. Specific to this Method. To achieve the desired effects, subject the test item to the full duration of the low pressure test without interruption; i.e., for either overtest or undertest interruptions, restart the test from the beginning. See paragraph 4.3.2 for test item operational failure guidance.

4.3.2 Interruption Due to Test Item Operation Failure.

Failure of the test item(s) to function as required during operational checks presents a situation with several possible options.

- a. The preferable option is to replace the test item with a “new” one and restart from step 1.
- b. A second option is to replace / repair the failed or non-functioning component or assembly with one that functions as intended, and restart the entire test from step 1.

NOTE: When evaluating failure interruptions, consider prior testing on the same test item and consequences of such.

4.4 Test Setup.

See Part One, paragraph 5.8.

4.5 Test Execution

The following steps, alone or in combination, provide the basis for collecting necessary information concerning the materiel in a low pressure environment. Unless otherwise specified, maintain the chamber temperature at standard ambient.

4.5.1 Preparation for test.

4.5.1.1 Preliminary steps.

Before starting the test, review pretest information in the test plan to determine test details (e.g., procedures, test item configuration, test altitude, altitude change rate, duration, parameter levels for storage/operation, etc.).

4.5.1.2 Pretest standard ambient checkout.

All test items require a pretest standard ambient checkout to provide baseline data. Conduct the checkout as follows:

- Step 1 Conduct a visual examination of the test item with special attention to stress areas, such as corners of molded cases, and document the results.
- Step 2 If required, install temperature sensors in or on the test item as described in the test plan. If required, install humidity sensor(s) in the chamber.
- Step 3 Conduct an operational checkout (Part One, paragraph 5.8.2) at standard ambient conditions (Part One, paragraph 5.1) and as described in the test plan, and record the results.
- Step 4 If the test item operates satisfactorily, proceed to the appropriate test procedure. If not, resolve the problems and repeat Steps 3 and 4. If resolution requires replacement of the item or removal of sensors in order to repair, then repeat Steps 1 through 3 above.

4.5.2 Procedure I - Storage/Air Transport.

- Step 1 Adjust the test item to its storage or transport configuration and install it in the test chamber.
- Step 2 If required, stabilize the test item to the required temperature and humidity (see paragraph 2.3.1). Ensure the temperature rate of change does not exceed 3°C/min (5°F/min).
- Step 3 Adjust the chamber air pressure to that which corresponds to the required test altitude, at an altitude change rate as specified in the test plan.
- Step 4 Maintain the conditions for a minimum of one hour unless otherwise specified in the test plan.

MIL-STD-810H
METHOD 500.6

- Step 5 If required, adjust the chamber air to standard ambient conditions at a rate not to exceed 3°C/min (5°F/min).
- Step 6 Visually examine the test item to the extent possible and conduct an operational check. Document the results, and see paragraph 5 for further guidance.

4.5.3 Procedure II - Operation/Air Carriage.

- Step 1 With the test item in its operational configuration, install it in the chamber and adjust the chamber air pressure (and temperature, if required – see paragraph 2.3.1) to that which corresponds to the required operational altitude at a rate not to exceed that specified in the test plan.
- Step 2 With the test item operating, maintain the conditions until the equipment reaches thermal stabilization (in accordance with Part One paragraph 5.4.1) unless otherwise specified in the test plan.
- Step 3 Conduct an operational check of the test item in accordance with the requirements documents, and document the results. If the test item does not operate satisfactorily, follow the guidance in paragraph 4.3.2 for test item failure.
- Step 4 If required, adjust the chamber air to standard ambient conditions at a rate not to exceed 3°C/min (5°F/min).
- Step 5 Visually examine the test item to the extent possible and conduct an operational check. Document the results, and see paragraph 5 for further guidance.

4.5.4 Procedure III - Rapid Decompression.

- Step 1 With the test item in the storage or transit configuration, install it in the chamber and adjust the chamber air pressure (and temperature if appropriate – see paragraph 2.3.1) at a rate not to exceed 3°C/min (5°F/min) or as otherwise specified in the test plan, to the cabin altitude (2,438 m (8,000 ft)) (see paragraph 2.3.1b).
- Step 2 Reduce the chamber air pressure to that which corresponds to the required test altitude of 12,192 m (40,000 ft) (18.8 kPa (2.73 psi)), or as otherwise specified in the test plan for the maximum flight altitude, in not more than 15 seconds. Maintain this stabilized reduced pressure for at least 10 minutes.
- Step 3 Adjust the chamber air to standard ambient conditions using a pressure change rate not greater than 10 m/s (32.8 ft/sec.), and if required a temperature change rate not to exceed 3°C/min (5°F/min).
- Step 4 Visually examine the test item to the extent possible. Document the results. Be alert for potential safety problems (see paragraph 5).

4.5.5 Procedure IV - Explosive Decompression.

- Step 1 With the test item in the configuration in which it is intended to function when installed, install it in the chamber and adjust the chamber air pressure (and temperature if required—see paragraph 2.3.1) at the rate specified in the test plan to the cabin altitude of 2,438 m (8,000 ft) (see paragraph 2.3.1b).
- Step 2 Reduce the chamber air pressure to that which corresponds to the required test altitude of 12,192 m (40,000 ft) or as otherwise specified in the test program, in not more than 0.1 seconds. Maintain this stabilized reduced pressure for at least 10 minutes.
- Step 3 Adjust the chamber air to standard ambient conditions using a pressure change rate not greater than 10 m/s (32.8 ft/sec.), and a temperature change rate not to exceed 3°C/min (5°F/min) if controlled.
- Step 4 Visually examine the test item to the extent possible. Document the results, and be alert for potential safety problems (see paragraph 5)

5. ANALYSIS OF RESULTS.

In addition to the guidance provided in Part One, paragraph 5.14, the following information may assist in the evaluation of the test results. For Procedures III and IV, the test item fails only if rapid or explosive decompression

MIL-STD-810H
METHOD 500.6

causes a hazard to the aircraft or to personnel; the test item need not show satisfactory post-test performance unless otherwise specified.

6. REFERENCE/RELATED DOCUMENTS.

6.1 Referenced Documents.

- a. MIL-HDBK-310, Global Climatic Data for Developing Military Products.
- b. NATO STANAG 4370, Allied Environmental Conditions and Test Publication (AECTP) 230.
- c. AR 70-38, Research, Development, Test and Evaluation of Materiel for Extreme Climatic Conditions; September 1979.

6.2 Related Documents.

- a. STANAG 4044, Adoption of a Standard Atmosphere, 10 April 1969, (ICAO Standard Atmosphere).
- b. STANAG 4370, Environmental Testing.
- c. Allied Environmental Conditions and Test Publication (AECTP) 300, Climatic Environmental Testing (Edition 3) (under STANAG 4370), Method 312.
- d. Synopsis of Background Material for MIL-STD-210B, Climatic Extremes for Military Equipment. Bedford, MA. US Air Force Cambridge Research Laboratories, 1974. DTIC number AD-780-508.
- e. Handbook of Geophysics and Space Environments. Bedford, MA. US Air Force Cambridge Research Laboratories, Office of Aerospace Research, 1965.
- f. US Standard Atmosphere, 1976. NOAA/NASA/USAF, 1976.
- g. Egbert, Herbert W. "The History and Rationale of MIL-STD-810, (Edition 2)," January 2010; Institute of Environmental Sciences and Technology, Arlington Place One, 2340 S. Arlington Heights Road, Suite 100, Arlington Heights, IL 60005-4516.

(Copies of Department of Defense Specifications, Standards, and Handbooks, and International Standardization Agreements are available online at <https://assist.dla.mil>.)

Requests for other defense-related technical publications may be directed to the Defense Technical Information Center (DTIC), ATTN: DTIC-BR, Suite 0944, 8725 John J. Kingman Road, Fort Belvoir VA 22060-6218, 1-800-225-3842 (Assistance--selection 3, option 2), <http://www.dtic.mil/dtic/> and the National Technical Information Service (NTIS), Springfield VA 22161, 1-800-553-NTIS (6847), <http://www.ntis.gov/>.

MIL-STD-810H
METHOD 501.7**METHOD 501.7**
HIGH TEMPERATURE**CONTENTS**

<u>Paragraph</u>	<u>Page</u>
1. SCOPE	1
1.1 PURPOSE	1
1.2 APPLICATION	1
1.3 LIMITATIONS.....	1
2. TAILORING GUIDANCE	1
2.1 SELECTING THIS METHOD.....	1
2.1.1 EFFECTS OF HIGH TEMPERATURE ENVIRONMENTS	1
2.1.2 SEQUENCE AMONG OTHER METHODS.....	2
2.2 SELECTING PROCEDURES	2
2.2.1 PROCEDURE SELECTION CONSIDERATIONS	2
2.2.2 DIFFERENCE AMONG PROCEDURES.....	3
2.3 DETERMINE TEST LEVELS AND CONDITIONS	3
2.3.1 CLIMATIC CONDITIONS	4
2.3.2 EXPOSURE CONDITIONS.....	6
2.3.3 EXPOSURE DURATION.....	7
2.3.3.1 CONSTANT TEMPERATURE EXPOSURE	7
2.3.3.2 CYCLIC TEMPERATURE EXPOSURE	8
2.3.4 TEST ITEM CONFIGURATION	8
2.3.5 HUMIDITY	8
2.4 TEST ITEM OPERATION	8
2.5 ADDITIONAL GUIDELINES.....	9
3. INFORMATION REQUIRED.....	9
3.1 PRETEST.....	9
3.2 DURING TEST.....	9
3.3 POST-TEST	9
4. TEST PROCESS	10
4.1 TEST FACILITY	10
4.2 CONTROLS	10
4.3 TEST INTERRUPTION	10
4.3.1 INTERRUPTION DUE TO CHAMBER MALFUNCTION.....	10
4.3.2 INTERRUPTION DUE TO TEST ITEM OPERATION FAILURE.....	11
4.4 TEST SETUP.....	11
4.5 TEST EXECUTION	11
4.5.1 PREPARATION FOR TEST.....	11
4.5.1.1 PRELIMINARY STEPS	11
4.5.1.2 PRETEST STANDARD AMBIENT CHECKOUT.....	11
4.5.2 PROCEDURE I - STORAGE	11
4.5.3 PROCEDURE II - OPERATION	12
4.5.4 PROCEDURE III - TACTICAL-STANDBY TO OPERATIONAL	13

MIL-STD-810H
METHOD 501.7**CONTENTS - Continued**

<u>Paragraph</u>	<u>Page</u>
5. ANALYSIS OF RESULTS	13
6. REFERENCE/RELATED DOCUMENTS	13
6.1 REFERENCED DOCUMENTS.....	13
6.2 RELATED DOCUMENTS.....	14

TABLES

TABLE 501.7-I SUMMARY OF HIGH TEMPERATURE DIURNAL CYCLE RANGES	4
TABLE 501.7-II HIGH TEMPERATURE CYCLES, CLIMATIC CATEGORY A2 - BASIC HOT	5
TABLE 501.7-III HIGH TEMPERATURE CYCLES, CLIMATIC CATEGORY A1 - BASIC DRY	6

MIL-STD-810H
METHOD 501.7**METHOD 501.7**
HIGH TEMPERATURE

NOTE: Tailoring is essential. Select methods, procedures, and parameter levels based on the tailoring process described in Part One, paragraph 4.2.2, and Annex C. Apply the general guidelines for laboratory test methods described in Part One, paragraph 5 of this Standard.

1. SCOPE.**1.1 Purpose.**

Use high temperature tests to obtain data to help evaluate effects of high temperature conditions on materiel safety, integrity, and performance.

1.2 Application.

Use this method to evaluate materiel likely to be deployed in areas where temperatures (ambient or induced) are higher than standard ambient.

1.3 Limitations.

Limit use of this Method to evaluating the effects of relatively short-term (months, as opposed to years), even, distributions of heat throughout the test item. This Method is not generally practical for:

- a. Evaluating time-dependent performance degradation (aging) effects that occur during continuous long-term exposure to high temperatures (under storage or operational modes) where synergetic effects may be involved. For such high temperature aging effects, test in the natural environment.
- b. Evaluating materiel in a high temperature environment where solar radiation produces significant thermal gradients in the materiel. For simulating direct solar impingement, use Method 505.7, Procedure I.
- c. Evaluating actinic (photochemical) effects (use Method 505.7, Procedure II).
- d. Evaluating the effects of aerodynamic heating without considerable tailoring.

2. TAILORING GUIDANCE.**2.1 Selecting This Method.**

After examining requirements documents and applying the tailoring process in Part One of this standard to determine where high temperatures are foreseen in the life cycle of the materiel, use the following to confirm the need for this Method, and to place it in sequence with other Methods. It is preferable to conduct Method 505.6, Procedure I prior to Method 501.7, in order to obtain maximum response and stabilization temperatures for items exposed to direct solar radiation.

2.1.1 Effects of High Temperature Environments.

High temperatures may temporarily or permanently impair performance of materiel by changing physical properties or dimensions of the material(s) of which it is composed. The following are examples of problems that could result from high temperature exposure that may relate to the materiel being tested. Consider the following typical problems to help determine if this Method is appropriate for the materiel being tested. This list is not intended to be all-inclusive.

- a. Parts bind from differential expansion of dissimilar materials.
- b. Lubricants become less viscous; joints lose lubrication by outward flow of lubricants.
- c. Materials change in dimension, either totally or selectively.
- d. Packing, gaskets, seals, bearings and shafts become distorted, bind, and fail causing mechanical or integrity failures.
- e. Gaskets display permanent set.
- f. Closure and sealing strips deteriorate.

MIL-STD-810H
METHOD 501.7

- g. Fixed-resistance resistors change in values.
- h. Electronic circuit stability varies with differences in temperature gradients and differential expansion of dissimilar materials.
- i. Transformers and electromechanical components overheat.
- j. Operating/release margins of relays and magnetic or thermally activated devices alter.
- k. Shortened operating lifetime.
- l. Solid pellets or grains separate.
- m. High pressures created within sealed cases (projectiles, bombs, etc.).
- n. Accelerated burning of explosives or propellants.
- o. Expansion of cast explosives within their cases.
- p. Explosives melt and exude.
- q. Discoloration, cracking, or crazing of organic materials.
- r. Out-gassing of composite materials or coatings (i.e. VOCs, CO, and Phthalates).
- s. Failure of adhesives.

2.1.2 Sequence Among Other Methods.

- a. General. Use the anticipated life cycle sequence of events as a general sequence guide (see Part One, paragraph 5.5).
- b. Unique to this Method. There are at least two philosophies related to test sequence. One approach is to conserve test item life by applying what are perceived to be the least damaging environments first. For this approach, generally apply the high temperature test early in the test sequence. Another approach is to apply environments to maximize the likelihood of disclosing synergetic effects. This test may be used in combination with shock and vibration tests to evaluate the effect of dynamic events (i.e., shipping, handling, and shock) on hot materials. Also, this test may contribute significantly to the results of low pressure testing of seals, e.g., see paragraphs 2.1.1d, e, and f.

2.2 Selecting Procedures.

This Method includes three test procedures, Procedure I (Storage), Procedure II (Operation), and Procedure III (Tactical-Standby to Operational). Determine the procedure(s) to be used.

NOTE: The materiel's anticipated Life Cycle Environmental Profile (LCEP) may reveal other high temperature scenarios that are not specifically addressed in the procedures. Tailor the procedures as necessary to capture the LCEP variations, but do not reduce the basic test requirements reflected in the below procedures. (See paragraph 2.3 below.) **NOTE: Consider the potential synergistic effects of temperature, humidity and altitude, and the use of Method 520.5 in addition to this method. However, Method 520 is NOT a substitute for Method 501.**

2.2.1 Procedure Selection Considerations.

When selecting procedures, consider:

- a. The operational purpose of the materiel.
- b. The natural exposure circumstances (ambient or induced).
- c. The test data required to determine whether the operational purpose of the materiel has been met.
- d. Procedure sequence. If both the storage and operation procedures are to be applied, perform Procedure I before Procedure II. Consider using Procedure III in lieu of Procedure II for unique cases in which materiel in its operational configuration is non-operational (awaiting use) and is exposed to solar heating, e.g., aircraft cockpits, ground vehicle passenger compartments, etc.

MIL-STD-810H
METHOD 501.7

- e. Other significant adjacent heat sources that could affect the materiel such as motors, engines, power supplies, other electronics, or exhaust air.
- f. Combining of Procedures I and II when using constant temperature. When attempting to combine procedures it is preferable to conduct Procedure II followed by Procedure I and then a repeat of Procedure II. Testing should be conducted in series with no return to ambient conditions until test completion.

2.2.2 Difference Among Procedures.

While all three procedures involve temperature conditioning and performance testing, they differ on the basis of the temperature load prior to and during performance tests. The storage procedure assesses the effects of high temperature storage on subsequent materiel performance. The operation procedure assesses the effects of high temperatures during performance. The tactical-standby to operational procedure evaluates the ability of materiel (usually enclosed by transparent or translucent material) that has soaked in the sun in a high temperature environment to become operational in a relatively short period of time.

- a. Procedure I - Storage. Use Procedure I to investigate how high temperatures during storage affect the materiel (integrity of materials, and safety/performance of the materiel). This test procedure includes exposing the test item to high temperatures (and low humidity where applicable) that may be encountered in the materiel's storage situation, followed by an operational test at ambient conditions. For materiel inside an enclosure that is, in turn, exposed to solar heating, consider using Method 505.7, Procedure I to determine the actual level of heating of the test materiel caused by solar loading.
- b. Procedure II - Operation. Use Procedure II to investigate how high ambient temperatures may affect materiel performance while it is operating. There are two ways to perform Procedure II:
 - (1) Expose the test item to cyclic chamber conditions with the test item operating either continuously or during the period of maximum response (highest item temperature).
 - (2) Expose the test item to a constant temperature and operate the test item when its temperature stabilizes. (To be used only for items situated in close proximity to heat-producing equipment or when it is necessary to verify operation of an item at a specified constant temperature.)
- c. Procedure III - Tactical-Standby to Operational. This procedure is not a substitute for solar radiation (Method 505.7). This procedure evaluates the materiel's performance at the operating temperatures after being presoaked at non-operational temperatures. Since actinic effects and directional heating are not applicable in this method, consider applying this procedure when materiel is in an enclosed environment, (e.g., aircraft and ground vehicles with closed transparent or translucent areas can develop high internal temperatures prior to equipment operation due to solar heating; enclosures such as communications shelters may require immediate operation after being exposed to solar heating). These are not items in storage or transit situation, but rather items in the operational configuration (ready-to-go as needed) that must be operational in a relatively short period of time. Usually, the "cooling" option refers to merely opening the enclosed areas and allowing the ambient air to begin cooling the interior areas so normal operation can begin.

The term "tactical" is used here to identify materiel that is not in storage, but is in a standby operational configuration, and as such is subjected to extended non-operational conditions immediately prior to operation.

2.3 Determine Test Levels and Conditions.

Having selected this method and relevant procedures (based on the test item's requirements documents and the tailoring process), complete the tailoring process by identifying appropriate parameter levels and applicable test conditions and techniques for these procedures. Base these selections on the requirements documents and the Life Cycle Environmental Profile, and information provided with this procedure. Consider the following when selecting test levels.

MIL-STD-810H
METHOD 501.7

2.3.1 Climatic Conditions.

Identify the appropriate climatic conditions for the geographic areas in which the materiel will be operated and stored. There are two climatic categories where high temperatures are typically encountered: Hot Dry and Basic Hot (Part One, Annex C, Figure C-1). Data for these areas are shown in Tables 501.7-I, -II, and -III. Determine high temperature levels with respect to:

- a. Climatic area of concern.
- b. Exposure to solar radiation: Is this exposure directly on the materiel, shipping container, protective package shelter, etc.?
- c. Analysis of the path of heat transfer from the ambient air and solar radiation to the materiel.

Table 501.7-I. Summary of high temperature diurnal cycle ranges.^{1/}

Design Type	Location	Ambient Air °C (°F)	Induced ^{2/} °C (°F)
Basic Hot (A2)	Many parts of the world, extending outward from the hot dry category of the southwestern United States, northwestern Mexico, central and western Australia, Saharan Africa, South America, southern Spain, and southwest and south central Asia.	30 - 43 (86 - 110)	30 - 63 (86 - 145)
Hot Dry (A1)	Southwest and south central Asia, southwestern United States, Saharan Africa, central and western Australia, and northwestern Mexico.	32 - 49 (90 - 120)	33 - 71 (91 - 160)

^{1/} The diurnal cycles for temperature and humidity are given in tables 501.7-II and -III.

^{2/} Induced conditions are air temperature levels to which materiel may be exposed during extreme storage or transit situations, or non-operational but in the operational configuration without containerization.

MIL-STD-810H
METHOD 501.7**Table 501.7-II. High temperature cycles, climatic category A2 - Basic Hot.^{1/}**

Time of Day	Ambient Air Conditions		Induced (Storage and Transit) Conditions		
	Temperature ^{3/}		Temperature ^{3/}		Humidity ^{2/}
	°C	(°F)	°C	(°F)	% RH
0100	33	(91)	33	(91)	36
0200	32	(90)	32	(90)	38
0300	32	(90)	32	(90)	41
0400	31	(88)	31	(88)	44
0500	30	(86)	30	(86)	44
0600	30	(86)	31	(88)	43
0700	31	(88)	34	(93)	32
0800	34	(93)	38	(101)	30
0900	37	(99)	42	(107)	23
1000	39	(102)	45	(113)	17
1100	41	(106)	51	(124)	14
1200	42	(107)	57	(134)	8
1300	43	(109)	61	(142)	6
1400	43	(110)	63	(145)	6
1500	43	(110)	63	(145)	5
1600	43	(110)	62	(144)	6
1700	43	(109)	60	(140)	6
1800	42	(107)	57	(134)	6
1900	40	(104)	50	(122)	10
2000	38	(100)	44	(111)	14
2100	36	(97)	38	(101)	19
2200	35	(95)	35	(95)	25
2300	34	(93)	34	(93)	28
2400	33	(91)	33	(91)	33

^{1/} These cycles were obtained from AR 70-38, 1 August 1979 (see paragraph 6.1, reference c), and essentially conform to those in MIL-HDBK-310 and NATO STANAG 4370, AECTP 230 (paragraph 6.1, references a and b). These values represent typical conditions throughout a typical day in this climatic category. "Induced Conditions" are air temperature levels to which materiel may be exposed during storage or transit situations that are aggravated by solar loading, or during non-operating situations but in an operational configuration and not containerized.

^{2/} Humidity control during high temperature testing is generally not necessary. Use these values only in special cases where, for instance, it is known that high levels of temperature and low humidity may adversely affect your items.

^{3/} Data were originally recorded in °F and converted to °C. Hence, table data conversion may not be consistent.

MIL-STD-810H
METHOD 501.7**Table 501.7-III. High temperature cycles, climatic category A1 – Hot Dry.^{1/}**

Time of Day	Ambient Air Conditions		Induced (Storage and Transit) Conditions		
	Temperature ^{3/}		Temperature ^{3/}		Humidity ^{2/} % RH
	°C	(°F)	°C	(°F)	
0100	35	(95)	35	(95)	6
0200	34	(94)	34	(94)	7
0300	34	(93)	34	(94)	7
0400	33	(92)	33	(92)	7
0500	33	(91)	33	(92)	7
0600	32	(90)	33	(91)	7
0700	33	(91)	36	(97)	5
0800	35	(95)	40	(104)	4
0900	38	(101)	44	(111)	4
1000	41	(106)	51	(124)	3
1100	43	(110)	56	(133)	2
1200	44	(112)	63	(145)	2
1300	47	(116)	69	(156)	1
1400	48	(118)	70	(158)	1
1500	48	(119)	71	(160)	1
1600	49	(120)	70	(158)	1
1700	48	(119)	67	(153)	1
1800	48	(118)	63	(145)	2
1900	46	(114)	55	(131)	2
2000	42	(108)	48	(118)	3
2100	41	(105)	41	(105)	5
2200	39	(102)	39	(103)	6
2300	38	(100)	37	(99)	6
2400	37	(98)	35	(95)	6

^{1/} These cycles were obtained from AR 70-38, 1 August 1979 (see paragraph 6.1, reference c), and essentially conform to those in MIL-HDBK-310 and NATO STANAG 4370, AECTP 230 (paragraph 6.1, references a and b). These values represent typical conditions throughout a typical day in this climatic category. "Induced Conditions" are air temperature levels to which materiel may be exposed during storage or transit situations that are aggravated by solar loading, or during non-operating situations but in an operational configuration and not containerized.

^{2/} Humidity control during high temperature testing is generally not necessary. Use these values only in special cases where, for instance, it is known that high levels of temperature and low humidity may adversely affect your item.

^{3/} Data were originally recorded in °F and converted to °C. Hence, table data conversion may not be consistent.

2.3.2 Exposure Conditions.

Before determining the levels at which to set test temperatures, determine the way in which the materiel is exposed to heat in normal storage and operational circumstances. Review the Life Cycle Environmental Profile (LCEP) to help make this determination (see Part Three for additional guidance). Consider at least the following exposure conditions, and the possible alternative of using Method 505.7, Procedure I:

MIL-STD-810H
METHOD 501.7

- a. Deployment configuration.
- (1) Exposed. Of interest are the most severe conditions that materiel would experience when deployed in any climatic area of the world without the benefit of a protective cover or sheltering enclosure.
 - (2) Sheltered. Of interest are the most severe conditions that materiel would experience when deployed in any climatic area of the world when under cover or inside a sheltering enclosure. The amount of ventilation available and the presence of adjacent shade can significantly affect the temperature of the air surrounding sheltered materiel. Examples of these situations are provided below. (Note: If field data are not available, the conditions for this exposure may be approximated using Part Three of this document, MIL-HDBK-310 and/or NATO STANAG 4370, AECTP 230 (paragraph 6.1, references a and b)). The outdoor ambient air temperature and humidity conditions described in these references are those measured in standard meteorological shelters at a height of 1.2 to 1.8 m (4 to 6 ft) above the ground.
 - (a) Inside unventilated enclosures.
 - (b) Within enclosed vehicle bodies.
 - (c) Within aircraft sections having surfaces exposed to solar heating.
 - (d) Inside of tents.
 - (e) Under closed tarpaulins.
 - (f) Located above, on, or below the surface of the Earth.
- b. Special conditions. Although high temperature testing is generally based on the average temperature of the air envelope surrounding the materiel, significant localized heating can occur because of special heating conditions. This localized heating can be well above the average surrounding air and therefore can significantly affect the evaluation of the materiel's thermal behavior and performance. When these conditions exist (as described below), include or simulate them in the high temperature test setup to the extent practical. These extreme conditions would be applied by extending the levels of the temperatures given in Tables 501.7-I and 501.7-II based on actual field measurements.
- (1) Aggravated solar. These conditions are induced but involve temperatures as high as 71 to 85 °C (160 to 185 °F), making greater allowance for the effects of solar radiation. Applicable conditions for such testing include materiel that is employed in enclosed compartments having glazed or transparent panels (aircraft cockpits, vehicle compartments, etc.); consider applying Method 505.7.
 - (2) Man-made sources. Man-made heat-producing devices (motors, engines, power supplies, high-density electronic packages, etc.) may significantly raise the local air temperature near the materiel, either by radiation, convection, or impingement of exhaust air. This near constant temperature environment may negate the effects of the diurnal cycle.

2.3.3 Exposure Duration.

Determine the duration of exposure that the materiel will experience for each of the exposure conditions identified. Exposure may be constant or cyclic, in which case, also identify the number of times that the exposure occurs.

Caution: When temperature conditioning, ensure the total test time at the most severe temperature does not exceed the life expectancy of any material (see Part One, paragraph 5.19).

2.3.3.1 Constant Temperature Exposure.

For constant temperature exposure (used only for items situated in close proximity to heat-producing equipment or when it is necessary to verify operation of an item at a specified constant temperature), soak the test item until its temperature has stabilized, and maintain the test temperature at least two hours following test item stabilization.

NOTE: This is not a substitute for situations in which diurnal cycling is typical.

MIL-STD-810H
METHOD 501.7

2.3.3.2 Cyclic Temperature Exposure.

For cyclic exposure, determine the test duration based on an estimate of the number of cycles required to satisfy the design requirements and the guidance below. The duration of high temperature exposure may be as significant as the temperature itself. Because Procedures I and II could expose the test items to cyclic temperatures, the number of cycles is critical. (Cycles are 24-hour periods unless otherwise specified.)

- a. Procedure I - Storage. The number of cycles for the storage test is set at a minimum of seven to coincide with the one percent frequency of occurrence of the hours of extreme temperatures during the most severe month in an average year at the most severe location. (The maximum temperature occurs for approximately one hour in each cycle.) When considering extended storage, critical materials, or materials determined to be very sensitive to high temperature, increase the number of cycles to assure the design requirements are met.
- b. Procedure II - Operation. The minimum number of cycles for the operational exposure test is three. This number is normally sufficient for the test item to reach its maximum response temperature. A maximum of seven cycles is suggested when repeated temperature response is difficult to obtain.

2.3.4 Test Item Configuration.

Determine the test item configuration based on realistic configuration(s) of the materiel anticipated for storage and operation. As a minimum, consider the following configurations:

- a. In a shipping/storage container or transit case.
- b. Protected or unprotected (under canopy, enclosed, etc.).
- c. In its normal operating configuration (realistic or with restraints, such as with openings that are normally covered).
- d. Modified with kits for special applications.
- e. Stacked or palletized configurations.

2.3.5 Humidity.

Generally, relative humidity (RH) control during high temperature tests is not necessary. In special cases, extremely low RH may have a significant effect on some materiel during high temperature testing. If the materiel has special characteristics that could be affected by extremely low RH, use the values for RH shown in Tables 501.7-II and -III.

2.4 Test Item Operation.

When it is necessary to operate the test item, use the following guidelines for establishing test operating procedures.

CAUTION: If the sheltered environment is intended to be occupied during exposure to high temperature, it is recommended that sensors are installed to detect VOCs, CO, and Phthalates due to potential out-gassing.

- a. General. See Part One, paragraph 5.8.2.
- b. Unique to this method.
 - (1) Include operating modes that consume the most power (generate the most heat).
 - (2) Include the required range of input voltage conditions if changes in voltage could affect the test item thermal dissipation or response (e.g., power generation or fan speed).
 - (3) Introduce the cooling media that normally would be applied during service use (e.g., forced air or liquid coolant). Consider using cooling medium inlet temperatures and flow rates that represent both typical and worst-case degraded temperature and flow conditions.
 - (4) For steady-state temperature testing, consider thermal stabilization to be achieved when the temperatures of critical internal operating components are relatively constant (as described in Part One, paragraph 5.4.1). (Because of test item duty cycling or the operating characteristics, a constant operating temperature may never be achieved.)

MIL-STD-810H
METHOD 501.7

- (5) For cyclic temperature testing, and depending on the cycle and test item characteristics, the thermal responses of the test item will also be cyclic.
- (6) Consider non-operational conditions similar to those of storage & transit, and the need for immediate operation without cooling - other than that of the surrounding ambient air.

2.5 Additional Guidelines.

Review the materiel specifications and requirements documents. Apply any additional guidelines necessary. Part Three of this document includes further information on the high temperature environment (e.g., paragraphs 2.1 and 4.1).

3. INFORMATION REQUIRED.**3.1 Pretest.**

The following information is required to conduct high temperature tests adequately.

- a. General. Information listed in Part One, paragraphs 5.7 and 5.9; and Annex A, Task 405 of this Standard.
- b. Specific to this Method.
 - (1) Relative humidity control requirements (if necessary). (See paragraph 2.3.5 of this Method.)
 - (2) Thermocouple locations. The component/assembly/structure to be used for thermal response and temperature stabilization purposes. (See Part One, paragraph 5.4.)
 - (3) For Procedure III, based on the LCEP, identify the anticipated maximum non-operational temperature (exposure to high temperatures and solar loading) for the materiel, as well as the accompanying high ambient temperature. The LCEP should define whether or not the item will be operated at the maximum operational temperature immediately following the storage environment.
- c. Tailoring. Necessary variations in the basic test procedures to accommodate environments identified in the LCEP.

3.2 During Test.

Collect the following information during conduct of the test:

- a. General. Information listed in Part One, paragraph 5.10; and in Annex A, Tasks 405 and 406 of this Standard.
- b. Specific to this Method.
 - (1) Record of chamber temperature-versus-time data (and humidity, if controlled) for the duration of the test.
 - (2) Record of the test item temperature-versus-time data for the duration of the test.

3.3 Post-Test.

The following post test data shall be included in the test report.

- a. General. Information listed in Part One, paragraph 5.13; and in Annex A, Task 406 of this Standard.
- b. Specific to this Method.
 - (1) Length of time required for each performance check.
 - (2) Temperature versus time data (test item and chamber).
 - (3) Any deviations from the original test plan.

MIL-STD-810H
METHOD 501.7**4. TEST PROCESS.****4.1 Test Facility.**

- a. The required apparatus consists of a chamber or cabinet together with auxiliary instrumentation capable of maintaining and monitoring the required conditions of high temperature (and humidity, where required) throughout an envelope of air surrounding the test item(s) (see Part One, paragraph 5.18).
- b. Unless justified by the materiel platform environment and to prevent unrealistic heat transfer in the materiel, maintain the air velocity in the vicinity of the test item so as to not exceed 1.7 m/s (335 ft/min).
- c. Continuously record chamber conditions and, if required, test item temperatures.

4.2 Controls.

- a. Temperature. Unless otherwise specified in the test plan, if any action other than test item operation (such as opening the chamber door) results in a significant change of the test item temperature (more than 2 °C (3.6 °F)) or chamber air temperature, re-stabilize the test item at the required temperature before continuing the test. For Procedure II, if the operational check is not completed within 15 minutes, reestablish test item temperature/RH conditions before continuing.
- b. Rate of temperature change. Unless otherwise specified or documented in the LCEP, use a rate of temperature change not exceeding 3 °C (5 °F) per minute to prevent thermal shock.
- c. Temperature measurement. Install temperature sensor instrumentation on or in the test item to measure temperature stabilization data (see Part One, paragraph 5.4).
- d. Data recording. Record chamber temperature (and humidity if controlled) in accordance with Part One, paragraphs 5.2 and 5.18, and at a sufficient rate to satisfy the post-test analysis (see Part One, paragraph 5.18)

4.3 Test Interruption.

Test interruptions can result from two or more situations, one being from failure or malfunction of test chambers or associated test laboratory equipment. The second type of test interruption results from failure or malfunction of the test item itself during required or optional performance checks.

4.3.1 Interruption Due to Chamber Malfunction.

- a. General. See Part One, paragraph 5.11, of this Standard.
- b. Specific to this Method.
 - (1) Undertest interruption.
 - (a) Cycling. If a cyclic high temperature test is being conducted and an unscheduled interruption occurs that causes the test conditions to fall out of allowable tolerances toward standard ambient temperatures, continue the test from the end of the last successfully-completed cycle.
 - (b) Steady state. If a steady state (non-cyclic) test is being conducted (only for items near constant-heat-producing sources), and an unscheduled interruption occurs that causes the test conditions to fall out of allowable tolerances toward standard ambient conditions, re-stabilize the test item at the required test temperature and continue the test from the point where test conditions were interrupted.
 - (2) Overtest interruption (e.g., loss of chamber control).
 - (a) Inspection and performance check. If an interruption in a cyclic or steady state test results in more extreme exposure of the test item than required by the materiel specifications, follow the interruption by a complete physical inspection and an operational check (where possible) before continuing the test.
 - (b) Safety, performance, materials problems. When these types of problems are discovered after an overtest, the preferable course of action is to terminate the test and re-initiate testing with a new test item. If this is not done and a test item failure occurs during the remainder of the test, the test

MIL-STD-810H
METHOD 501.7

results could be considered invalid because of the overttest conditions. If no problem has been encountered, reestablish pre-interruption conditions and continue from the point where the test tolerances were exceeded.

4.3.2 Interruption Due to Test Item Operation Failure.

Failure of the test item(s) to function as required during mandatory or optional performance checks during testing presents a situation with several possible options.

- a. The preferable option is to replace the test item with a “new” one and restart from Step 1.
- b. A second option is to replace / repair the failed or non-functioning component or assembly with one that functions as intended, and restart the entire test from Step 1.

NOTE: When evaluating failure interruption, consider prior testing on the same test item and consequences of such.

4.4 Test Setup.

- a. General. See Part One, paragraph 5.8.
- b. Unique to this Method. Include in the test setup any additional heat sources or an appropriate simulation (see paragraph 2.3.2b).

4.5 Test Execution.

The following steps, alone or in combination, provide the basis for collecting necessary information concerning the materiel in a high temperature environment.

4.5.1 Preparation for Test.

4.5.1.1 Preliminary Steps.

Before starting the test, review pretest information in the test plan to determine test details (e.g., procedures, test item configuration, cycles, durations, parameter levels for storage/operation, etc.). (See paragraph 3.1, above.)

4.5.1.2 Pretest Standard Ambient Checkout.

All test items require a pretest standard ambient checkout to provide baseline data. Conduct the checkout as follows:

- Step 1 Conduct a visual examination of the test item with special attention to stress areas, such as corners of molded cases, and document the results.
- Step 2 In order to determine thermal response (paragraph 3.1c), install temperature sensors in, on, or around the test item as described in the test plan.
- Step 3 Conduct an operational checkout (Part One, paragraph 5.8.2) at standard ambient conditions (Part One, paragraph 5.1) as described in the plan and record the results.
- Step 4 If the test item operates satisfactorily, proceed to paragraph 4.5.2, 4.5.3, or 4.5.4 as appropriate. If not, resolve the problems and repeat Step 3 above. If resolution requires replacement of the item or removal of sensors in order to repair, then repeat Steps 1 through 3 above.

4.5.2 Procedure I - Storage.

NOTE: If the LCEP has defined the need to operate the test item at the high operational temperature immediately following storage, consider using Procedure III.

- Step 1 Place the test item in its storage configuration and install it in the chamber.
- Step 2 Adjust the chamber environment to the required test conditions, either cyclic exposure (Tables 501.7-II or 501.7-III) or constant exposure (see paragraph 2.3.3.1), for the start of the test period at a rate not to exceed 3 °C/min (5 °F/min). Maintain for the specified time following temperature stabilization of the test item.

MIL-STD-810H
METHOD 501.7

- Step 3 a. For cyclic storage, expose the test item to the temperature (and humidity, if applicable) conditions of the storage cycle for a minimum of seven continuous 24-hour cycles, or as specified in the LCEP and the test plan. Record the thermal response of the test item.
- b. For constant temperature storage (to be used only for items situated in close proximity to equipment producing constant high temperatures; see paragraph 2.3.2b(2)), maintain the test temperature at least two hours following test item temperature stabilization (see Part One, paragraph 5.4). The additional two hours will help ensure unmeasured internal components actually reach stabilization. If not possible to instrument internal components, base any additional soak time on thermal analysis to ensure temperature stabilization throughout the test item.
- Step 4 At the completion of the constant temperature soak or the last cycle, adjust the chamber air temperature to standard ambient conditions and maintain until the test item temperature is stabilized.
- Step 5 Conduct a visual examination and operational checkout of the test item, and record the results for comparison with pretest data. See paragraph 5 for analysis of results.

4.5.3 Procedure II - Operation.

- Step 1 With the test item in the chamber in its operational configuration, install any additional temperature sensors necessary to measure the maximum temperature response of the test item, ensuring the functioning components are included.
- Step 2 If performing the constant temperature exposure, go to Step 3. For cycling temperature exposure, go to Step 8.
- Step 3 Constant temperature exposure. Adjust the chamber air conditions to the required temperature (and humidity, if applicable) at which the materiel must operate at rate not to exceed 3 °C/min (5 °F/min).
- Step 4 Maintain the chamber conditions at least two hours following test item temperature stabilization (see Part One, paragraph 5.4). If not possible to instrument internal components, base the additional soak time on thermal analysis or previously measured data to ensure temperature stabilization throughout the test item.
- Step 5 Conduct as thorough a visual examination of the test item as possible considering chamber access limitations, and document the results for comparison with pretest data.
- Step 6 Operate the test item and allow its temperature to re-stabilize. Conduct an operational checkout of the test item in accordance with the test plan and document the results for comparison with pretest data. If the test item fails to operate as intended, follow the guidance in paragraph 4.3.2 for test item failure.
- Step 7 Skip Steps 8 through 10 and proceed directly to Step 11.
- Step 8 Cycling temperature exposure. Adjust the chamber air temperature (and humidity, if applicable) to the initial conditions, of the operational cycle appropriate for materiel deployment, at a rate not to exceed 3 °C/min (5 °F/min). Maintain until the test item's temperature has stabilized.
- Step 9 Expose the test item to at least three cycles or the number of cycles necessary to assure repeated test item response. Document the maximum test item response temperature. Conduct as complete a visual examination of the test item as possible considering chamber access limitations. Document the results.
- Step 10 Operate the test item during the maximum test item temperature response period of the exposure cycle. If the test item fails to operate as intended, follow the guidance in paragraph 4.3.2 for test item failure. The maximum test item temperature response period may not coincide with the maximum temperature cycle conditions because of the thermal lag of the test item. Repeat until a successful operational checkout of the test item has been accomplished in accordance with the approved test plan, and the results have been documented.
- Step 11 With the test item not operating, adjust the chamber air temperature to standard ambient conditions and maintain until the test item temperature has stabilized.

MIL-STD-810H
METHOD 501.7

Step 12 Conduct a complete visual examination and operational checkout in accordance with the approved test plan and document the results for comparison with pretest data. See paragraph 5 for analysis of results.

4.5.4 Procedure III - Tactical-Standby to Operational.

- Step 1 With the test item in the chamber and in its tactical configuration, install any additional temperature sensors necessary to measure the temperature response of the test item, ensuring the functioning components are included.
- Step 2 Adjust the chamber air temperature to the anticipated maximum non-operating temperature, and maintain this temperature until the test item temperature has stabilized, plus a minimum of two additional hours to ensure complete stabilization.
- Step 3 Adjust the chamber air temperature to the high operational temperature identified in the LCEP as quickly as possible (at a rate no less than 2 °C (3.6 °F) per-minute). As soon as the chamber instrumentation indicates this temperature has been reached, operate the test item in accordance with the approved test plan and document the results for comparison with pretest data. If the test item fails to operate as intended, follow the guidance in paragraph 4.3.2 for test item failure. If identified in the LCEP that the item will be subjected to multiple exposures of this environment, repeat Steps 2 and 3 as required by the test plan.
- Step 4 With the test item not operating, adjust the chamber air temperature to standard ambient conditions and maintain until the test item temperature has stabilized.
- Step 5 Conduct a complete visual examination and operational checkout in accordance with the approved test plan, and document the results for comparison with pretest data. See paragraph 5 for analysis of results.

5. ANALYSIS OF RESULTS.

In addition to the guidance provided in Part One, paragraphs 5.14 and 5.17, the following information is provided to assist in the evaluation of the test results. Apply any data relative to failure of a test item to meet the requirements of the materiel specifications to the test analysis, and consider related information such as:

- a. Results of nondestructive examinations (if any) of materiel at the temperature extreme.
- b. Degradation or changes in operating characteristics allowed at the high extreme temperatures.
- c. Necessity for special kits or special operating procedures for high temperature exposure.
- d. Evidence of improper lubrication and assurance that the lubricants specified for the environmental condition were used.
- e. For Procedure III, the amount of time required for the test item to become operational.

6. REFERENCE/RELATED DOCUMENTS.

6.1 Referenced Documents.

- a. MIL-HDBK-310, Global Climatic Data for Developing Military Products.
- b. NATO STANAG 4370, Allied Environmental Conditions and Test Publication (AECTP) 230; Climatic Conditions.
- c. AR 70-38, Research, Development, Test and Evaluation of Materiel for Extreme Climatic Conditions.
- d. MIL-STD-2105C, Test Method Standard – Hazard Assessment Tests for Non-Nuclear Munitions.

MIL-STD-810H
METHOD 501.7

6.2 Related Documents.

- a. Synopsis of Background Material for MIL-STD-210B, Climatic Extremes for Military Equipment. Bedford, MA: Air Force Cambridge Research Laboratories, 24 January 1974. DTIC number AD-780-508.
- b. NATO STANAG 4370, Environmental Testing.
- c. Allied Environmental Conditions and Test Publication (AECTP) 300, Climatic Environmental Tests (under STANAG 4370), Method 302.
- d. Egbert, Herbert W. "The History and Rationale of MIL-STD-810 (Edition 2)" January 2010," Institute of Environmental Sciences and Technology, Arlington Place One, 2340 S. Arlington Heights Road, Suite 100, Arlington Heights, IL 60005-4516.

(Copies of Department of Defense Specifications, Standards, and Handbooks, and International Standardization Agreements are available online at <https://assist.dla.mil>.)

Requests for other defense-related technical publications may be directed to the Defense Technical Information Center (DTIC), ATTN: DTIC-BR, Suite 0944, 8725 John J. Kingman Road, Fort Belvoir VA 22060-6218, 1-800-225-3842 (Assistance--selection 3, option 2), <http://www.dtic.mil/dtic/> and the National Technical Information Service (NTIS), Springfield VA 22161, 1-800-553-NTIS (6847), <http://www.ntis.gov/>.

MIL-STD-810H
METHOD 502.7**METHOD 502.7**
LOW TEMPERATURE**CONTENTS**

<u>Paragraph</u>	<u>Page</u>
1. SCOPE	1
1.1 PURPOSE	1
1.2 APPLICATION	1
1.3 LIMITATIONS.....	1
2. TAILORING GUIDANCE	1
2.1 SELECTING THE LOW TEMPERATURE METHOD	1
2.1.1 EFFECTS OF LOW TEMPERATURE ENVIRONMENTS	1
2.1.2 SEQUENCE AMONG OTHER METHODS.....	2
2.2 SELECTING PROCEDURES	2
2.2.1 PROCEDURE SELECTION CONSIDERATIONS	2
2.2.2 DIFFERENCE AMONG PROCEDURES.....	2
2.3 DETERMINE TEST LEVELS AND CONDITIONS	3
2.3.1 CLIMATIC CONDITIONS	3
2.3.2 EXPOSURE DURATION.....	5
2.3.3 TEST ITEM CONFIGURATION	5
2.3.4 ADDITIONAL GUIDELINES	5
3. INFORMATION REQUIRED.....	5
3.1 PRETEST.....	5
3.2 DURING TEST.....	6
3.3 POST-TEST	6
4. TEST PROCESS	6
4.1 TEST FACILITY	6
4.2 CONTROLS	6
4.3 TEST INTERRUPTION	6
4.3.1 INTERRUPTION DUE TO CHAMBER MALFUNCTION.....	7
4.3.2 INTERRUPTION DUE TO TEST ITEM OPERATION FAILURE.....	7
4.4 TEST SETUP.....	7
4.5 TEST EXECUTION	7
4.5.1 PREPARATION FOR TEST.....	7
4.5.1.1 PRELIMINARY STEPS	7
4.5.1.2 PRETEST STANDARD AMBIENT CHECKOUT.....	7
4.5.2 PROCEDURE I - STORAGE	8
4.5.3 PROCEDURE II - OPERATION	8
4.5.4 PROCEDURE III - MANIPULATION.....	9
5. ANALYSIS OF RESULTS	9
6. REFERENCE/RELATED DOCUMENTS	10
6.1 REFERENCED DOCUMENTS.....	10
6.2 RELATED DOCUMENTS.....	10

MIL-STD-810H
METHOD 502.7

TABLES

TABLE 502.7-I SUMMARY OF LOW TEMPERATURE CYCLE RANGES	4
TABLE 502.7-II FREQUENCIES OF OCCURRENCE OF EXTREME LOW TEMPERATURES	4

MIL-STD-810H
METHOD 502.7**METHOD 502.7**
LOW TEMPERATURE

NOTE: Tailoring is essential. Select methods, procedures, and parameter levels based on the tailoring process described in Part One, paragraph 4.2.2, and Annex C. Apply the general guidelines for laboratory test methods described in Part One, paragraph 5 of this Standard.

1. SCOPE.**1.1 Purpose.**

Use low temperature tests to obtain data to help evaluate effects of low temperature conditions on materiel safety, integrity, and performance during storage, operation, and manipulation.

1.2 Application.

Use this Method to evaluate materiel likely to be exposed to a low temperature environment during its life cycle.

1.3 Limitations.

This Method is not intended to simulate the high altitude, low temperature environment associated with an unpressurized aircraft at altitude. However, this method may be used in conjunction with Method 500.6 to simulate the high altitude, low temperature environment.

2. TAILORING GUIDANCE.**2.1 Selecting the Low Temperature Method.**

After examining requirements documents and applying the tailoring process in Part One of this Standard to determine where low temperatures are foreseen in the life cycle of the materiel, use the following to confirm the need for this Method and to place it in sequence with other methods.

2.1.1 Effects of Low Temperature Environments.

Low temperatures have adverse effects on almost all basic material. As a result, exposure of materiel to low temperatures may either temporarily or permanently impair the operation of the materiel by changing the physical properties of the material(s) of which it is composed. Consider low temperature tests whenever the materiel will be exposed to temperatures below standard ambient, and consider the following typical problems to help determine if this Method is appropriate for the materiel being tested. This list is not intended to be all-inclusive.

- a. Hardening and embrittlement of materials.
- b. Binding of parts from differential contraction of dissimilar materials and the different rates of expansion of different parts in response to temperature transients.
- c. Loss of lubrication and lubricant flow due to increased viscosity. In addition, fuels may gel at low temperature.
- d. Changes in electronic components (resistors, capacitors, etc.).
- e. Changes in performance of transformers and electromechanical components.
- f. Stiffening of shock mounts.
- g. Cracking of explosive solid pellets or grains, such as ammonium nitrate.
- h. Cracking and crazing, change in impact strength, and reduced strength.
- i. Static fatigue of restrained glass.
- j. Effects due to condensation and freezing of water in or on the materiel.
- k. Decrease in dexterity, hearing, and vision of personnel wearing protective clothing.
- l. Change of burning rates.

MIL-STD-810H
METHOD 502.7

2.1.2 Sequence Among Other Methods.

- a. General. Use the anticipated life cycle sequence of events as a general sequence guide (see Part One, paragraph 5.5).
- b. Unique to this Method. There are at least two philosophies related to test sequence. One approach is to conserve test item life by applying what are perceived to be the least damaging environments first. For this approach, generally apply the low temperature test early in the test sequence. Another approach is to apply environments to maximize the likelihood of disclosing synergetic effects. This test may also be used in combination with shock and vibration tests to evaluate the effect of dynamic events (i.e., shipping, handling, and shock) on cold materials. Also, this test may significantly alter the performance of seals during the low pressure testing of Method 500.6.

2.2 Selecting Procedures.

This Method includes three test procedures, Procedure I (Storage), Procedure II (Operation), and Procedure III (Manipulation). Based on the test data requirements, determine which test procedure, combination, or sequence of procedures is applicable. In most cases, all three procedures will apply.

NOTE: The materiel's anticipated Life Cycle Environmental Profile (LCEP) may reveal other low temperature scenarios that are not specifically addressed in the procedures. Tailor the procedures as necessary to capture the LCEP variations, but do not reduce the basic test requirements reflected in the below procedures. (See paragraph 2.3 below.) **NOTE: Consider the potential synergistic effects of temperature, humidity and altitude, and the use of Method 520.5 in addition to this method. However, Method 520 is NOT a substitute for Method 502.**

2.2.1 Procedure Selection Considerations.

When selecting procedures, consider:

- a. The operational purpose of the materiel. From the requirements documents, determine the functions to be performed by the materiel in a low temperature environment and any limiting conditions, such as storage.
- b. The natural exposure circumstances.
- c. The test data required to determine whether the operational purpose of the materiel has been met.
 - (1) The expected temperature at the deployment location.
 - (2) The expected duration at the deployment location.
 - (3) The test item configuration.
- d. Procedure sequence.
 - (1) If the materiel is not intended to be stored at low temperature or manipulated before use, Procedure II is conducted as a standalone test.
 - (2) Combining of Procedures I and II when using constant temperature. When attempting to combine procedures it is preferable to conduct Procedure II followed by Procedure I and then a repeat of Procedure II. Testing should be conducted in series with no return to ambient conditions until test completion. If manipulation test is required, Procedure III can precede one or both operational tests.

2.2.2 Difference Among Procedures.

While all procedures involve low temperatures, they differ on the basis of the timing and nature of performance tests.

- a. Procedure I - Storage. Use Procedure I to investigate how low temperatures during storage affect materiel safety during and after storage, and performance after storage.
- b. Procedure II - Operation. Use Procedure II to investigate how well the materiel operates in low temperature environments. For the purpose of this document, operation is defined as excitation of the materiel with a minimum of contact by personnel. It does not exclude handling (manipulation).

MIL-STD-810H
METHOD 502.7

- c. Procedure III - Manipulation. Use Procedure III to investigate the ease with which the materiel can be set up or assembled, operated, and disassembled by personnel wearing heavy, cold-weather clothing. In addition, this could also include maintenance procedures.

2.3 Determine Test Levels and Conditions.

Having selected this Method and relevant procedures (based on the test item's requirements documents and the tailoring process), complete the tailoring process by identifying appropriate parameter levels and applicable test conditions and techniques for these procedures. Base these selections on the requirements documents, the Life Cycle Environmental Profile (LCEP), and information provided with this procedure. Consider the following when selecting test levels.

2.3.1 Climatic Conditions.

Select the specific test temperatures, preferably from the requirements documents. If this information is not available, determine the test temperature(s) based on the world areas in which the materiel will be used, plus any additional considerations. Although the natural low temperature environment is normally cyclic, the effect of solar loading is minimal, if not absent, so in most instances it is acceptable to use a constant low temperature test. Only in those instances where design assessment suggests that exposure to varying low temperatures may be important are the appropriate cold cycles from MIL-HDBK-310, AR 70-38, or STANAG 4370, AECTP 230 (paragraph 6.1, references a, b, and c) recommended. The information below provides guidance for choosing the test temperatures for selected regions (climatic categories), for worldwide use without extended storage (two years or longer), and for worldwide use with extended storage periods.

- a. Selected regions. Table 502.7-I in this Method, and Figure C-3 and Table C-I in Part One, Annex C, Part One of this Standard can be used to determine the test temperature when the test item is to be used within specific regions only. Except for severe cold, that is based on a 20 percent frequency of occurrence, air temperature criteria shown in Table 502.7-I are based on a one percent frequency of occurrence of the hours during an average year at the most severe location within the geographical area encompassed by the climatic region. The values shown in Table 502.7-I represent the range of the diurnal cycles. The diurnal cycles can be found in Part Three, Tables 9 and 11. For this Method, the lowest value in each range is usually considered.
- b. Worldwide use. When the materiel is to be stored or operated worldwide, temperature selection must not only include consideration of the absolute cold, but also of the frequency of a given cold condition. Unless frequency is considered, it is possible to create an unrealistic overtest condition. In terms of frequency, the frequency-of-occurrence values shown in Table 502.7.I refer to the percent of total hours, in the most extreme month and area in the world, during which the given cold temperature is equaled or exceeded. For example, the 20 percent frequency of occurrence of a temperature of -51 °C (-60 °F) means that during an average year, a temperature of -51 °C (-60 °F) or lower may be expected to occur 20 percent of the hours during the most extreme month in the cold area of the world. A 20 percent frequency of occurrence is used for most applications with normal development cost considerations. However, to satisfy specific applications or test requirements, other more extreme values may be appropriate. (See Table 502.7-II.)

NOTE: Antarctica is excluded from consideration by international treaty restrictions.
--

MIL-STD-810H
METHOD 502.7**Table 502.7-I. Summary of Low Temperature Cycle Ranges.**

DESIGN TYPE	LOCATION	TEMPERATURE ¹	
		Ambient Air °C (°F)	Induced Environment (Storage & Transit) °C (°F)
Basic Cold (C1)	Most of Europe; Northern contiguous US; Coastal Canada; High-latitude coasts (e.g., southern coast of Alaska); High elevations in lower latitudes	-21 to -32 (-5 to -25)	-25 to -33 (-13 to -28)
Cold (C2)	Canada, Alaska (excluding the interior); Greenland (excluding the "cold pole"); Northern Scandinavia; Northern Asia (some areas), High Elevations (Northern and Southern Hemispheres); Alps; Himalayas; Andes	-37 to -46 (-35 to -50)	-37 to -46 (-35 to -50)
Severe Cold (C3)	Interior of Alaska; Yukon (Canada); Interior of Northern Canadian Islands; Greenland ice cap; Northern Asia	-51 (-60)	-51 (-60)

¹These cycles were derived from AR 70-38, 1 August 1979, and essentially conform to those in MIL-HDBK-310 and NATO STANAG 4370, AECTP 230 (except for category C0). These values represent typical conditions. Induced conditions are extreme levels to which materiel may be exposed during storage or transit situations. Do not use these levels carte blanche, but tailor them to the anticipated storage or transit situation.

NOTE: See Part Three Tables IX and XI for low-temperature diurnal temperatures.

Table 502.7-II. Frequencies of Occurrence of Extreme Low Temperatures.

Low Temperature	Frequency of Occurrence
-51 °C ¹ (-60 °F)	20 percent
-54 °C (-65 °F)	10 percent
-57 °C (-71 °F)	5 percent
-61 °C (-78 °F)	1 percent

¹Corresponds to the "Severe Cold" condition.

- c. Worldwide use with extended storage periods. If materiel is to be stored for extended periods (years) without shelter or protection in areas that experience extreme low temperatures such as the "cold pole" of northeast Siberia or central Greenland, there is an increased chance that the materiel may experience much lower temperatures (approaching -65 °C (-85 °F)). Such prolonged exposure to extreme low temperatures can affect the safety of items such as munitions, life support equipment, etc.

MIL-STD-810H
METHOD 502.7**2.3.2 Exposure Duration.**

The duration of exposure to low temperature may be a factor in materiel safety, integrity and performance.

- a. Nonhazardous or non-safety-related (non-life-support type) materiel. Most materiel in this category (in a non-operating mode), with the possible exception of rubber and plastics, will not experience deterioration following temperature stabilization of the materiel at low temperatures. Following temperature stabilization of the test item, use a storage period of four hours for this materiel if no other value is available.
- b. Explosives, munitions, rubber and plastics, etc. These items may continue to deteriorate following temperature stabilization; consequently, it is necessary to test them at low temperatures for long periods of time. Use a minimum storage period of 72 hours following temperature stabilization of the test item.
- c. Restrained glass. Glass, ceramics, and glass-type products (such as those used in optical systems, laser systems, and electronic systems) that require mounting or restraining in specific positions may experience static fatigue. A more extended period of low temperature may be required to induce this phenomenon. Use a minimum storage period of 24 hours following temperature stabilization of the test item. In some cases, glass will only reveal static fatigue to low temperature after previously being subjected to other environments.

2.3.3 Test Item Configuration.

The configuration of the materiel is an important factor in how it may be affected by temperature. Therefore, use the anticipated configuration of the materiel during storage or use during the test. As a minimum, consider the following configurations:

- a. In a shipping/storage container or transit case.
- b. Protected or unprotected.
- c. Deployed (realistically or with restraints, such as with openings that are normally covered).
- d. Modified with kits for special applications.

2.3.4 Additional Guidelines.

Review the materiel specifications and requirements documents. Apply any additional guidelines necessary. Part Three of this document includes further information on the low temperature environment (e.g., paragraphs 2.2, 2.3, 4.2.6, and 4.3).

3. INFORMATION REQUIRED.**3.1 Pretest.**

The following information is required to conduct low temperature tests adequately.

- a. General. Information listed in Part One, paragraphs 5.7 and 5.9, and Part One, Annex A, Task 405 of this Standard.
- b. Specific to this Method.
 - (1) Test temperatures, type of protective clothing required, and any additional guidelines.
 - (2) Temperature sensor locations. The component/assembly/structure to be used for thermal response and temperature stabilization purposes. (See Part One, paragraph 5.4.)
- c. Tailoring. Necessary variations in the basic test procedures to accommodate environments identified in the LCEP.

MIL-STD-810H
METHOD 502.7**3.2 During Test.**

Collect the following information during conduct of the test:

- a. General. Information listed in Part One, paragraph 5.10, and in Annex A, Tasks 405 and 406 of this Standard.
- b. Specific to this Method.
 - (1) Record of chamber temperature versus time conditions.
 - (2) Test item temperatures (measurement locations).
 - (3) Protective clothing used during manipulation tests.

3.3 Post-Test.

The following post test data shall be included in the test report.

- a. General. Information listed in Part One, paragraph 5.13, and in Annex A, Task 406 of this Standard.
- b. Specific to this Method.
 - (1) Length of time required for each performance check.
 - (2) Temperature versus time data (test item and chamber).
 - (3) Clothing and special equipment used to set up or disassemble the test item.
 - (4) Appropriate anthropometric measurements of personnel performing manipulation tests.
 - (5) Any deviations from the original test plan.

4. TEST PROCESS.**4.1 Test Facility.**

- a. The required apparatus consists of a chamber or cabinet and auxiliary instrumentation capable of maintaining and monitoring (see Part One, paragraph 5.18) the required conditions of low temperature throughout an envelope of air surrounding the test item.
- b. Unless otherwise justified by the materiel platform environment and to prevent unrealistic heat transfer in the materiel, maintain the air velocity in the vicinity of the test item so as to not exceed 1.7 m/s (335 ft/min).

4.2 Controls.

- a. Temperature. Unless otherwise specified in the test plan, if any action other than test item operation (such as opening the chamber door) results in a significant change of the test item temperature (more than 2 °C (3.6 °F)), restabilize the test item at the required temperature before continuing. If the operational check is not completed within 15 minutes, reestablish the test item temperature conditions before continuing.
- b. Rate of temperature change. Unless otherwise specified, control the rate of temperature change to not exceed 3 °C (5 °F) per minute to prevent thermal shock.
- c. Temperature measurement. Install temperature sensor(s) on or in the test item to measure temperature stabilization data (see Part One, paragraph 5.4).
- d. Temperature recording. Record chamber temperature at a sufficient rate to capture data necessary for post-test analysis (see Part One, paragraph 5.18).

4.3 Test Interruption.

Test interruptions can result from two or more situations, one being from failure or malfunction of test chambers or associated test laboratory equipment. The second type of test interruption results from failure or malfunction of the test item itself during operational checks.

MIL-STD-810H
METHOD 502.7**4.3.1 Interruption Due to Chamber Malfunction.**

- a. General. See Part One, paragraph 5.11 of this Standard.
- b. Specific to this Method.
 - (1) Undertest interruption. Follow an interruption that allows test temperatures to fluctuate outside allowable tolerances toward ambient conditions by a complete physical inspection and operational check (where possible). If no problems are encountered, restabilize the test item at the test temperature and continue from the point of the interruption. Since no extreme conditions were encountered, consider any problems as a test item failure.
 - (2) Overtest interruption. Follow any interruption (loss of chamber control) that results in more extreme exposure of the test item than required by the materiel specification by a complete physical examination and operational check (where possible) before any continuation of testing. This is especially true where a safety problem could exist, such as with munitions. If a problem is discovered, the preferable course of action is to terminate the test and reinitiate testing with a new test item. If this is not done and test item failure occurs during the remainder of the test, the test results could be considered invalid because of the overtest condition. If no problem has been encountered, reestablish pre-interruption conditions and continue from the point where the test tolerances were exceeded. See paragraph 4.3.2 for test item operational failure guidance.

4.3.2 Interruption Due to Test Item Operation Failure.

Failure of the test item(s) to function as required during operational checks presents a situation with several possible options.

- a. The preferable option is to replace the test item with a “new” one and restart from Step 1 of the pretest requirements.
- b. A second option is to replace / repair the failed or non-functioning component or assembly within the test item with one that functions as intended, and restart the entire test from Step 1 of the pretest requirements.

<p>NOTE: When evaluating failure interruptions, consider prior testing on the same test item, and consequences of such.</p>
--

4.4 Test Setup.

- a. See Part One, paragraph 5.8.
- b. Unique to this Method. There is no guidance unique to this Method.

4.5 Test Execution.

The following steps, alone or in combination, provide the basis for collecting necessary information concerning the test item in a low temperature environment. Conduct pretest and post test operational checkouts after storage and after manipulation to verify successful completion of both procedures.

4.5.1 Preparation for Test.**4.5.1.1 Preliminary Steps.**

Before starting the test, review pretest information in the test plan to determine test details (e.g., procedures, test item configuration, cycles, durations, parameter levels for storage/operation, etc.).

4.5.1.2 Pretest Standard Ambient Checkout.

All test items require a pretest standard checkout at standard ambient conditions to provide baseline data. Conduct the checkout as follows (change of step sequence may be required for large test items):

- Step 1 Conduct a complete visual examination of the test item, with special attention to stress areas such as corners of molded cases, and document the results.

MIL-STD-810H
METHOD 502.7

- Step 2 Install temperature sensors in or on the test item as required to determine the test item temperature(s). If not possible to instrument internal components, base any additional soak time on thermal analysis to ensure temperature stabilization throughout the test item.
- Step 3 Conduct an operational checkout at standard ambient conditions (See Part One, paragraph 5.1), and in accordance with the approved test plan and record the results.
- Step 4 If the test item operates satisfactorily; proceed to the first test procedure as determined from the test plan. If not, resolve the problems and repeat Steps 3 and 4. If resolution requires replacement of the item or removal of sensors in order to repair, then repeat Steps 1 through 3 above.

4.5.2 Procedure I - Storage.

- Step 1 Place the test item in its storage configuration and install it in the test chamber.
- Step 2 Adjust the chamber air temperature to that specified in the test plan for storage at a rate not to exceed 3 °C/min (5 °F/min).
- Step 3 Stabilize the test item at the storage temperature (Part One, paragraph 5.4) and maintain for the duration as specified in the test plan. If not possible to instrument internal components, base any additional soak time on thermal analysis to ensure temperature stabilization throughout the test item.
- Step 4 Conduct a visual examination of the test item and compare the results with the pretest data. Record any pertinent physical changes or the fact that there were no obvious changes.
- Step 5 Adjust the chamber air temperature to standard ambient conditions (at a rate not to exceed 3 °C/min (5 °F/min)), and maintain it until the test item has achieved temperature stabilization.
- Step 6 Conduct a complete visual examination of the test item and document the results.
- Step 7 If appropriate, conduct an operational checkout of the test item and document the results. See paragraph 5 for analysis of results.
- Step 8 Compare these data with the pretest data.

4.5.3 Procedure II - Operation.

- Step 1 With the test item in its operational configuration and installed in the test chamber, adjust the chamber air temperature to the low operating temperature of the test item as specified in the test plan at a rate not to exceed 3°C/min (5°F/min). Maintain this for at least two hours following temperature stabilization of the test item. If not possible to instrument internal components, base any additional soak time on thermal analysis to ensure temperature stabilization throughout the test item.
- Step 2 Conduct as complete a visual examination of the test item as chamber access limitations will allow, and document the results.
- Step 3 Conduct an operational checkout of the test item and record results for comparison with data obtained in paragraph 4.5.1.2. If the test item fails to operate as intended, see paragraph 5 for analysis of results, and follow the guidance in paragraph 4.3.2 for test item failure.
- Step 4 If manipulation of the test item is required at low temperature; proceed to Step 2 of paragraph 4.5.4. If not, proceed to Step 5 of this procedure.
- Step 5 Adjust the chamber air temperature to standard ambient conditions at a rate not to exceed 3 °C/min (5 °F/min), and maintain it until temperature stabilization of the test item has been achieved.
- Step 6 Conduct a complete visual examination of the test item, and document the results.
- Step 7 If appropriate; conduct an operational checkout and record results for comparison with data obtained in paragraph 4.5.1.2. If the test item fails to operate as intended, see paragraph 5 for analysis of results, and follow the guidance in paragraph 4.3.2 for test item failure.

MIL-STD-810H
METHOD 502.7

4.5.4 Procedure III - Manipulation.

- Step 1 With the test item in the test chamber and in its storage configuration, adjust the chamber air temperature to the low operating temperature of the test item as determined from the test plan at a rate not to exceed 3°C/min (5°F/min). Maintain it for two hours following temperature stabilization of the test item.
- Step 2 While maintaining the low operating temperature, place the test item in its normal operating configuration. Based on the type of test chamber available, select one of the two following options:
- Option 1 - To be used when a "walk-in" type chamber is available: With personnel clothed and equipped as they would be in a low temperature tactical situation, disassemble the test item as would be done in the field, and repack it in its normal shipping/storage container(s), transit case, or other mode and configuration.
- Option 2 - To be used when small chambers (non-walk-in) are used: Perform the option 1 procedure, except the disassembly and packing will be performed by personnel reaching through chamber access holes or the open door while they are wearing heavy gloves such as would be required in the natural environment.

NOTE: Opening of the chamber door may cause frost to form on the test item in addition to a gradual warming of the test item. Limit manipulation necessary to perform the required setup or teardown to 15-minute intervals, between which reestablish the temperature of Step 1 above.

- Step 3 Reestablish the temperature to that used in Step 1, above and maintain it for two hours following temperature stabilization of the test item.
- Step 4 If operation of the test item is required at low temperatures; proceed to Step 1 of paragraph 4.5.3. If not, proceed to Step 5 of this procedure.
- Step 5 Conduct a complete visual examination of the test item, and document the results for comparison with the pretest data.
- Step 6 Adjust the chamber air temperature to standard ambient conditions (at a rate not to exceed 3 °C/min (5 °F/min)), and maintain it until the test item has reached temperature stabilization.
- Step 7 Conduct a complete visual examination of the test item, and document the results.
- Step 8 If appropriate; conduct an operational checkout of the test item and record results for comparison with data obtained in paragraph 4.5.1.2. If the test item fails to operate as intended, see paragraph 5 for analysis of results, and follow the guidance in paragraph 4.3.2 for test item failure.

5. ANALYSIS OF RESULTS.

In addition to the guidance provided in Part One, paragraph 5.14, the following information is provided to assist in the evaluation of the test results. Apply any data relative to failure of a test item to meet the requirements of the materiel specifications to the test analysis, and consider related information such as:

- a. Nondestructive test/examination following exposure to low temperature may be conducted at the low test temperature.
- b. Degradation allowed in operating characteristics when at low temperatures.
- c. Necessity for special kits or special cold weather procedures.
- d. Evidence of improper lubrication and assurance that lubricants specified for the environmental condition were used.
- e. For starting failure on internal combustion engines, assurance of the presence of proper fuels and deicers, if appropriate.
- f. Condition and adequacy of the power source.

MIL-STD-810H
METHOD 502.7

6. REFERENCE/RELATED DOCUMENTS.

6.1 Referenced Documents.

- a. MIL-HDBK-310, Global Climatic Data for Developing Military Products.
- b. AR 70-38, Research, Development, Test and Evaluation of Materiel for Extreme Climatic Conditions.
- c. NATO STANAG 4370, Allied Environmental Conditions and Test Publication (AECTP) 230; Climatic Conditions.
- d. MIL-STD-2105C, Test Method Standard - Hazard Assessment Tests for Non-Nuclear Munitions.

6.2 Related Documents.

- a. Synopsis of Background Material for MIL-STD-210B, Climatic Extreme for Military Equipment. Bedford, MA: Air Force Cambridge Research Laboratories, January 1974. DTIC number AD-780-508.
- b. STANAG 4370, Environmental Testing.
- c. Allied Environmental Conditions and Test Publication (AECTP) 300, Climatic Environmental Tests (under STANAG 4370), Method 303.
- d. Egbert, Herbert W. "The History and Rationale of MIL-STD-810 (Edition 2)", January 2010; Institute of Environmental Sciences and Technology, Arlington Place One, 2340 S. Arlington Heights Road, Suite 100, Arlington Heights, IL 60005-4516.

(Copies of Department of Defense Specifications, Standards, and Handbooks, and International Standardization Agreements are available online at <https://assist.dla.mil>.)

Requests for other defense-related technical publications may be directed to the Defense Technical Information Center (DTIC), ATTN: DTIC-BR, Suite 0944, 8725 John J. Kingman Road, Fort Belvoir VA 22060-6218, 1-800-225-3842 (Assistance--selection 3, option 2), <http://www.dtic.mil/dtic/>; and the National Technical Information Service (NTIS), Springfield VA 22161, 1-800-553-NTIS (6847), <http://www.ntis.gov/>.

MIL-STD-810H
METHOD 503.7**METHOD 503.7**
TEMPERATURE SHOCK**CONTENTS**

<u>Paragraph</u>	<u>Page</u>
1. SCOPE	1
1.1 PURPOSE	1
1.2 APPLICATION	1
1.3 LIMITATIONS.....	1
2. TAILORING GUIDANCE	2
2.1 SELECTING THIS METHOD.....	2
2.1.1 EFFECTS OF THERMAL SHOCK ENVIRONMENTS	2
2.1.2 SEQUENCE AMONG OTHER METHODS.....	2
2.2 SELECTING PROCEDURES	2
2.2.1 PROCEDURE SELECTION CONSIDERATIONS	3
2.2.2 PROCEDURE VARIATIONS.....	3
2.3 DETERMINE TEST LEVELS AND CONDITIONS	3
2.3.1 CLIMATIC CONDITIONS	3
2.3.2 EXPOSURE CONDITIONS	3
2.3.3 TEST DURATION (NUMBER OF SHOCKS)	4
2.3.4 TEST ITEM CONFIGURATION	4
2.3.5 TEMPERATURE STABILIZATION.....	5
2.3.6 RELATIVE HUMIDITY	5
2.3.7 TRANSFER TIME	5
2.4 SPECIAL CONSIDERATIONS.....	5
3. INFORMATION REQUIRED.....	5
3.1 PRETEST	5
3.2 DURING TEST	6
3.3 POST-TEST	6
4. TEST PROCESS	6
4.1 TEST FACILITY	6
4.1.1 APPARATUS.....	6
4.1.2 INSTRUMENTATION	6
4.2 CONTROLS	6
4.2.1 TEMPERATURE	7
4.2.2 AIR-VELOCITY	7
4.2.3 TRANSFER TIME	7
4.3 TEST INTERRUPTION	7
4.3.1 INTERRUPTION DUE TO CHAMBER MALFUNCTION.....	7
4.3.2 INTERRUPTION DUE TO TEST ITEM OPERATION FAILURE.....	7
4.4 TEST EXECUTION	8
4.4.1 PREPARATION FOR TEST.....	8
4.4.2 PROCEDURE I - SHOCK FROM CONSTANT EXTREME TEMPERATURE	8
4.4.2.1 PROCEDURE I-A - ONE-WAY SHOCK(S) FROM CONSTANT EXTREME TEMPERATURE	9
4.4.2.2 PROCEDURE I-B - SINGLE SHOCK FROM CONSTANT EXTREME TEMPERATURE	9
4.4.2.3 PROCEDURE I-C - MULTI-CYCLE SHOCK FROM CONSTANT EXTREME TEMPERATURE	10
4.4.2.4 PROCEDURE I-D - SHOCKS TO OR FROM CONTROLLED AMBIENT TEMPERATURE	11

MIL-STD-810H
METHOD 503.7**CONTENTS - Continued**

<u>Paragraph</u>	<u>Page</u>
5. ANALYSIS OF RESULTS	12
6. REFERENCE/RELATED DOCUMENTS	12
6.1 REFERENCED DOCUMENTS.....	12
6.2 RELATED DOCUMENTS.....	12

FIGURES

FIGURE 503.7-1 SINGLE SHOCK (1/2 CYCLE).....	9
FIGURE 503.7-2 SINGLE CYCLE SHOCKS.....	10
FIGURE 503.7-3 MULTI-CYCLE SHOCKS.....	11
FIGURE 503.7-4 SHOCKS TO & FROM CONTROLLED AMBIENT	12

MIL-STD-810H
METHOD 503.7

METHOD 503.7
TEMPERATURE SHOCK

NOTE: Tailoring is essential. Select methods, procedures, and parameter levels based on the tailoring process described in Part One, paragraph 4.2.2, and Annex C. Apply the general guidelines for laboratory test methods described in Part One, paragraph 5 of this standard.

1. SCOPE.

1.1 Purpose.

Use the temperature shock test to determine if materiel can withstand sudden changes in the temperature of the surrounding atmosphere without experiencing physical damage or deterioration in performance. For the purpose of this document, "sudden changes" is defined as "an air temperature change greater than 10°C (18°F) within one minute".

1.2 Application.

1.2.1 Normal Environment.

Use this Method when the requirements documents specify the materiel is likely to be deployed where it may experience sudden changes of air temperature. This Method is intended to evaluate the effects of sudden temperature changes of the outer surfaces of materiel, items mounted on the outer surfaces, or internal items situated near the external surfaces. This Method, essentially, focuses on test item surface-levels. Typically, this addresses:

- a. The transfer of materiel between climate-controlled environment areas and extreme external ambient conditions or vice versa, e.g., between an air conditioned enclosure and desert high temperatures, or from a heated enclosure in the cold regions to outside cold temperatures.
- b. Ascent from a high temperature ground environment to high altitude via a high performance vehicle (hot to cold only).
- c. Air delivery/air drop at high altitude/low temperature from aircraft enclosures when only the external material (packaging or materiel surface) is to be tested.

1.2.2 Safety and Screening.

Except as noted in paragraph 1.3, use this Method to reveal safety problems and potential flaws in materiel normally exposed to less extreme rates of temperature change (as long as the test conditions do not exceed the design limitations of the materiel).

1.3 Limitations.

This method does not specifically address the following, but it may, in some cases, be applied through tailoring:

- a. Materiel that will not experience sudden extreme temperature changes to internal components because of its mass, configuration, packaging, installed location, etc.
- b. Replacement of the assessment of performance characteristics after lengthy exposure to extreme temperatures, such as with Methods 501.7 and 502.7.
- c. Temperature shock experienced by materiel transferred between air and liquid or two liquids, the thermal shock caused by rapid transient warmup by engine compressor bleed air, or aerodynamic loading.
- d. The actual transfer time in a service environment will not produce a significant thermal shock.
- e. Materiel that has been exposed to heat from a fire and subsequently cooled with water.
- f. Thermal shock testing that may be considered for safety or hazard assessment of munitions.

MIL-STD-810H
METHOD 503.7**2. TAILORING GUIDANCE.****2.1 Selecting This Method.**

After examining requirements documents and applying the tailoring process in Part One of this Standard to determine where thermal shocks are foreseen in the life cycle of the materiel, use the following to confirm the need for this method and to place it in sequence with other methods.

2.1.1 Effects of Thermal Shock Environments.

Effects of thermal shocks are usually more severe near the outer portions of materiel. The further from the surface (depending, of course, on the properties of the material involved), the slower and less significant are the thermal changes. Transit cases, packaging, etc., will lessen the effects of thermal shock on the enclosed materiel even more. Sudden temperature changes may either temporarily or permanently affect operation of materiel. The following are examples of problems that could result from thermal shock exposure that may relate to the materiel being tested. Consider the following typical problems to help determine if this method is appropriate for the materiel being tested. This list is not intended to be all-inclusive.

- a. Physical.
 - (1) Shattering of glass vials and optical materiel.
 - (2) Binding or slackening of moving parts.
 - (3) Cracking of solid pellets or grains in explosives.
 - (4) Differential contraction or expansion rates or induced strain rates of dissimilar materials.
 - (5) Deformation or fracture of components.
 - (6) Cracking of surface coatings.
 - (7) Leaking of sealed compartments.
 - (8) Failure of insulation protection.
- b. Chemical.
 - (1) Separation of constituents.
 - (2) Failure of chemical agent protection.
- c. Electrical.
 - (1) Changes in electrical and electronic components.
 - (2) Electronic or mechanical failures due to rapid water or frost formation.

2.1.2 Sequence Among Other Methods.

- a. General. Use the anticipated life cycle sequence of events as a general sequence guide (see Part One, paragraph 5.5).
- b. Unique to this method. Use test item response characteristics and performance determination information obtained from the high and low temperature tests to better define the test conditions to be used for this procedure.

2.2 Selecting Procedure Variations.

This method includes one test procedure with four variations – essentially in the length of the test and the shock itself. It employs constant temperature at each of the extreme shock conditions because, in many instances, the thermal shock itself so outweighs the other thermal effects that the test may be performed using two constant temperatures. This is particularly the case when more severe shocks are desired, such as for evaluation of safety or initial design, and when extreme values will be used. The four variations are:

- a. Procedure I-A - One-way Shock(s) from Constant Extreme Temperature.
- b. Procedure I-B - Single Cycle Shock from Constant Extreme Temperature.

MIL-STD-810H
METHOD 503.7

- c. Procedure I-C - Multi-Cycle Shocks from Constant Extreme Temperature.
- d. Procedure I-D - Shocks To or From Controlled Ambient Temperature.

2.2.1 Procedure Selection Considerations.

When selecting this procedure, consider:

- a. The expected exposure temperatures in service.
- b. The materiel's logistic or deployment configuration.

2.2.2 Procedure Variations.

The four procedure variations all involve temperature conditioning and performance testing. They differ on the number of shocks that, based on the LCEP, can vary from one shock (1/2 cycle) to six or more shocks (three or more cycles). Paragraph 2.3 includes five possible options, but only use 2.3c and d for cyclic situations.

2.3 Determine Test Levels and Conditions.

Having selected this method (based on the test item's requirements documents and the tailoring process), complete the tailoring process by identifying appropriate parameter levels and applicable test conditions and techniques for the procedure. Base these selections on the requirements documents, the Life Cycle Environmental Profile (LCEP), requirements documents (see Part One, Figure 1-1), and information provided with this method. Consider tailoring known service extreme temperatures if the intent of the test is to reproduce induced strain rates found in service. Use values other than those suggested if realistic. This method addresses several exposure situations: aircraft flight exposure, air delivery - desert, and ground transfer – ambient to either cold regions or desert. Based on the anticipated deployment, determine which test variation is applicable. Rather than focusing solely on shocks from low to high temperatures or vice-versa, exposure temperatures could reflect shocks from controlled ambient temperature conditions to high or low temperatures. Base the exposure range on the expected service conditions, but extend the test levels as necessary to detect design flaws. Stabilize the whole test item temperature or, if known, the point of interest prior to transfer. However, if the LCEP indicates a duration less than that required to achieve stabilization, the duration from the LCEP should be used. The critical point of interest may be near the surface of the item. In such cases, a considerably shorter duration may apply rather than complete stabilization of the item. Justify any duration less than complete stabilization. Consider the following when selecting test levels.

- a. Aircraft flight exposure. This is appropriate if the materiel is to be exposed to desert or tropical ground heat and possible direct solar heating and, immediately afterwards, exposed to the extreme low temperatures associated with high altitude (see paragraph 1.2.1b). If not expended, the test item could subsequently be exposed to a potential thermal shock when the platform aircraft returns to a hot ambient environment. In addition, if not expended, the item could also be subjected to multiple thermal shocks.
- b. Air delivery - desert. This is appropriate for materiel that is delivered over desert terrain from unheated, high altitude aircraft, but use the ambient air temperature (no solar loading).
- c. Ground transfer - ambient to or from either cold regions or desert. This is intended to test materiel for the effects of movement to and from ambient conditions and cold regions or desert environments.
- d. Engineering design. This is used to detect issues related to marginal design.

2.3.1 Climatic Conditions.

Identify the appropriate climatic conditions for the geographic areas in which the materiel will be operated and stored. Actual response temperatures achieved when materiel is exposed to the climatic conditions of the various ground climatic categories could be obtained from the test results of high and low temperature exposure (Methods 501.7, 502.7, and 505.6) for either the operational, or storage configuration. The latter assumption must take into account the induced effects of solar radiation during storage and transit in various climates.

2.3.2 Exposure Conditions.

Select the test temperatures from field data or from the requirements documents, if available. If not available, determine the test temperatures from the anticipated deployment application or world areas in which the materiel will be deployed, or from the most extreme non-operating temperature requirements. Recommend using a range of temperatures that reflects that anticipated in-service, rather than some arbitrary extreme range.

MIL-STD-810H
METHOD 503.7

- a. Deployment application (aircraft flight exposure). The thermal stresses and rates that materiel will experience during exposure to the air flight operational environment are dependent on the ambient conditions, flight conditions, and performance of the onboard environmental control systems. The temperature and humidity at various altitudes can be found in MIL-HDBK-310 (paragraph 6.1, reference a).
- b. Air delivery/air drop. The test conditions for this exposure are based upon the probable conditions in the cargo compartment of the aircraft (or other transport location), and on the ground at the point of impact. Use a lower temperature extreme that assumes an unheated, unpressurized aircraft cargo compartment with the aircraft at an altitude of 8 kilometers (26,200 ft). This is the limiting altitude for cargo aircraft because of oxygen pressure requirements when the aircraft cargo compartment is unpressurized immediately before air drop operations. The temperature at this altitude can be found in MIL-HDBK-310. Determine the high temperature surface extremes from the appropriate tables in Method 501.7.

NOTE: Materiel packaging will normally mitigate thermal shocks to the packaged item. The air delivery/air drop scenario of packaged items may not involve significant thermal shock to the contents. However, the packaging may experience adverse effects due to the thermal shock.

- c. Ground transfer – ambient to or from cold regions or desert. In some regions of the world, materiel could experience thermal shocks during movement to and from environmentally conditioned buildings (enclosures) to extreme exterior ambient temperature conditions. Base selection of the outside ambient conditions upon the climatic categories or areas listed in the appropriate tables in Methods 501.7 or 502.7.
 - (1) Cold regions. Typically, conditions for cold regions enclosures are indoor air at 18 °C to 24 °C (65 °F to 75 °F), with an accompanying RH of 30 to 50% (paragraph 6.1, reference d). These conditions roughly correspond to normal heating practices in cold regions.
 - (2) Desert. For transfer from a desert environment to an air conditioned enclosure, determine if solar heating of the materiel will occur prior to the transfer.
- d. Engineering design. Use test conditions that reflect the extreme anticipated storage conditions.

2.3.3 Test Duration (number of shocks).

- a. Procedure I-A One-way shock(s) from constant extreme temperature. For materiel that is likely to be exposed only rarely to thermal shock in one direction, perform at least one shock for each appropriate condition, i.e., low to high temperature, or vice-versa (Figure 503.7-1 and paragraph 4.4.2.1a).
- b. Procedure I-B Single cycle shock from constant extreme temperature. For materiel that is likely to be exposed to only one thermal shock cycle (one in each direction), perform one shock for each appropriate condition, i.e., low-to-high temperature, and one in the opposite direction (Figure 503.7-2 and paragraph 4.4.2.1b).
- c. Procedure I-C Multi-cycle shocks from constant extreme temperature. There is little available data to substantiate a specific number of shocks when more frequent exposure is expected. In lieu of better information, apply a minimum of three shocks at each condition, i.e., three transfers from cold to hot, three transfers from hot to cold, and a stabilization period after each transfer. The number of shocks depends primarily on the anticipated service events (paragraph 503.7-3 and paragraph 4.4.2.1c). The objective of this test is to determine the effect of rapid temperature changes to the materiel. Therefore, expose the test item to the temperature extremes for a duration equal to either the actual operation, or to that required to achieve temperature stabilization within the limitations shown in paragraphs 1.2.1, 1.3, 2.1.1, and 2.3.5.
- d. Procedure I-D Shocks to or from controlled ambient temperature. This procedure essentially follows the durations of Procedures I-A to I-C, except all shocks are to and/or from controlled ambient conditions (Figure 503.7-4 and paragraph 4.4.2.1d).

2.3.4 Test Item Configuration.

The configuration of the test item strongly affects test results. Therefore, use the anticipated configuration of the item during storage, shipment, or use. For small test items (e.g., radios), the test configuration should be representative of the in-Service condition, and provide a similar mounting platform thermal mass. As a minimum, consider the following configurations:

MIL-STD-810H
METHOD 503.7

- a. In a shipping/storage container or transit case, and installation of a thermally conditioned item into a container conditioned at another temperature.
- b. Protected or unprotected.
- c. Deployed (realistically or with restraints).
- d. Modified with kits for special applications.
- e. Packaged for airdrop.
- f. The installed environment and the effect upon the test item thermal response.

2.3.5 Temperature Stabilization.

Stabilize the test item temperature (prior to transfer, and within the limitations shown in paragraphs 1.2.1, 1.3, and 2.1.1) or, if known, the point of interest prior to transfer, for as long as necessary to ensure a uniform temperature throughout at least the outer portions of the test item. However, if the LCEP indicates a duration less than that required to achieve stabilization, the duration from the LCEP should be used. The critical point of interest may be near the surface of the item. In such cases, a considerably shorter duration may apply rather than complete stabilization of the item. Justify any duration less than complete stabilization.

2.3.6 Relative Humidity.

For most test programs, the relative humidity (RH) is not controlled. During the thermal shock test it may, however, have a significant effect on some materiel, e.g., cellulosic materials that are typically porous, into which moisture can migrate and then expand upon freezing. Do not attempt to control relative humidity unless specifically required.

2.3.7 Transfer Time.

Ensure the transfer time reflects the time associated with the actual thermal shock in the life cycle profile. Make the transfer as rapidly as possible, but if the transfer takes more than one minute, justify the extra time.

2.4 Special Considerations.

The test conditions as presented in this method are intended to be in general agreement with other extremes described in this document. The primary purpose in establishing these levels is to provide realistic conditions for the traverse between the two temperature extremes. Therefore, before transfer, stabilize the test item (within the limitations shown in paragraphs 1.2.1, 1.3, 2.1.1, and 2.3.5) at the most realistic temperature that would be encountered during the specific operation, or possibly the most extreme test item stabilization temperature if appropriate. Consider tailoring known service extreme temperatures if the intent of the test is to reproduce induced strain or heat transfer rates found in service.

3. INFORMATION REQUIRED.

3.1 Pretest.

The following information is required to conduct temperature shock tests adequately.

- a. General. Information listed in Part One, paragraphs 5.7 and 5.9, and Annex A, Task 405 of this standard.
- b. Specific to this method.
 - (1) Test item configuration.
 - (2) Test temperature extremes or test item thermal rates of change.
 - (3) Duration of exposure at each temperature.
 - (4) Test item response temperature (from either Method 501.7 or 505.7).
 - (5) The component/assembly/structure to be used for thermal response and temperature stabilization purposes (if required). (See Part One, paragraph 5.4.)
 - (6) The number and type of shocks, i.e., shocks from low temperature to high temperature or vice-versa, or a combination of these.

MIL-STD-810H
METHOD 503.7

- c. Tailoring. Necessary variations in the basic test procedures to accommodate environments identified in the LCEP.

3.2 During Test.

Collect the following information during conduct of the test:

- a. General. Information listed in Part One, paragraph 5.10, and in Annex A, Task 406 of this Standard.
- b. Specific to this method.
 - (1) Record of chamber temperature versus time conditions.
 - (2) Test item temperatures (measured locations).
 - (3) Transfer times (e.g., "door open" to "door closed").
 - (4) Duration of each exposure.
 - (5) Transfer method (single or multi-chamber).

For test validation purposes, record deviations from planned or pre-test procedures or parameter levels, including any procedural anomalies that may occur.

3.3 Post-Test.

The following post-test data shall be included in the test report:

- a. General. Information listed in Part One, paragraph 5.13, and in Annex A, Tasks 405 and 406 of this Standard.
- b. Specific to this method.
 - (1) Test temperatures.
 - (2) Duration of each exposure.
 - (3) Number of cycles.
 - (4) Transfer times (e.g., "door open" to "door closed").
 - (5) Results of operational checks.
 - (6) Status of the test item for each visual examination.
 - (7) Previous test methods, if any, to which the specific test item has been exposed.
 - (8) Any deviations from the original test plan.

4. TEST PROCESS.**4.1 Test Facility.****4.1.1 Apparatus.**

The required apparatus consists of two chambers or cabinets, or a two-celled chamber in which the test conditions can be established and maintained. Unless otherwise specified, use chambers equipped so that after the transfer of the test item, the test conditions within the chamber can be stabilized within five minutes. Use materiel handling equipment, if necessary, for transfer of the test item between chambers.

4.1.2 Instrumentation.

Use chambers equipped with auxiliary instrumentation capable of monitoring (see Part One, paragraph 5.18) the test conditions throughout an envelope of air surrounding the test item(s). (See Part One, paragraphs 5.2a and 5.3.) Quick-disconnect thermocouples may be necessary for monitoring test item conditions following transfers.

4.2 Controls.

Record chamber temperature, and if required humidity, at a sufficient rate to capture data necessary for post-test analysis (see Part One, paragraph 5.18).

MIL-STD-810H
METHOD 503.7**4.2.1 Temperature.**

Unless otherwise specified in the test plan, if any action other than test item operation (such as opening of the chamber door, except at transfer time) results in a significant change (more than 2 °C (3.6 °F)) of the test item temperature or chamber air temperature, stabilize the test item at the required temperature in accordance with paragraph 2.3.5 before continuation.

4.2.2 Air Velocity.

Unless justified by the materiel's platform environment or logistic scenario, and to provide standard testing conditions, use an air velocity that does not exceed 1.7 m/s (335 ft/min) in the vicinity of the test item. A test tailored to meet a specific air velocity or platform environment may require the specification of the air velocity, temperature change rate, or transfer time.

4.2.3 Transfer Time.

Transfer the test item between the two environments within one minute. If the item is large and requires materiel handling equipment, justify the additional time required to move the item.

4.3 Test Interruption.

Test interruptions can result from two or more situations, one being from malfunction of test chambers or associated test laboratory equipment. The second type of test interruption results from failure or malfunction of the test item itself during performance checks (required or optional).

4.3.1 Interruption Due to Chamber Malfunction.

- a. General. See Part One, paragraph 5.11 of this standard.
- b. Specific to this method.
 - (1) Undertest interruption. If, during the temperature dwell, an unscheduled test interruption occurs that causes the test conditions to exceed allowable tolerances toward controlled ambient temperatures, reinitiate the test at the point of interruption and stabilize the test item in accordance with paragraph 2.3.5 at the pre-transfer test condition. If the interruption occurs during the transfer, stabilize the test item at the previous temperature and then transfer.
 - (2) Overtest interruption. Following any interruption that results in more extreme exposure of the test item than that required by the materiel specification, conduct a complete physical examination and operational check of the test item (where possible), before any continuation of testing. This is especially true where a safety problem could exist, such as with munitions. If no problem is discovered, reestablish pre-interruption conditions and continue from the point where the test tolerances were exceeded. If the test item fails to operate or a visual defect is noted:
 - (a) Follow the guidance in paragraph 4.3.2, or
 - (b) Replace / repair the failed or non-functioning component or assembly with one that functions as intended, reestablish pre-failure test conditions, and continue the test from the point of interruption.

4.3.2 Interruption Due to Test Item Operation Failure.

Failure of the test item(s) to function as required during required or optional performance checks during testing presents a situation with several possible options. See Part One, paragraph 5.11 of this standard.

- a. The preferable option is to replace the test item with a "new" one and restart from Step 1.
- b. A second option is to replace / repair the failed or non-functioning component or assembly with one that functions as intended, and restart the entire test from Step 1.

If a failure occurs near the end of a sequential test, consider repairing the test item and then re-starting the temperature shock test from beginning. One must consider that prior testing using the same test item may have induced effects that surface during these or subsequent methods. Repeating the sequential environmental tests previously performed, but with a new test item, must be considered. If this is not done and test item failure occurs during the remainder of the test, the test results could be invalid due to the overtest condition.

MIL-STD-810H
METHOD 503.7

NOTE: When evaluating failure interruptions, consider prior testing on the same test item and consequences of such.

4.4 Test Execution.

The following steps, alone or in combination, provide the basis for collecting necessary information concerning the materiel's susceptibility to temperature shock.

4.4.1 Preparation for Test.

4.4.1.1 Preliminary Steps.

Before starting the test, review pretest information in the test plan to determine test details (e.g., procedures, test item configuration, temperature levels, cycles, temperature stabilization determination, durations, etc.). (See paragraph 3.1 above.)

4.4.1.2 Pretest Standard Ambient Checkout.

All test items require a pretest standard ambient checkout to provide baseline data. Examine munitions and other appropriate materiel by nondestructive examination methods. Conduct the checkout as follows:

- Step 1 Conduct a complete visual examination of the test item (evaluate against paragraph 2.1.1) with special attention to stress areas such as corners of molded areas and interfaces between different materials (e.g., component lead/ceramic interfaces of visible electronic parts), and document the results for comparison with post test data.
- Step 2 In order to determine thermal response (paragraph 3.1b), install temperature sensors in, on, or around the test item as described in the test plan. This step can be conducted before or after Step 3.
- Step 3 Conduct an operational checkout at standard ambient conditions (Part One, paragraph 5.1), and in accordance with the approved test plan, and record the results.
- Step 4 If the test item operates satisfactorily, proceed to the next step. If not, resolve the problems and restart at Step 1, above.
- Step 5 With the test item in the chamber in its appropriate configuration, adjust the chamber air temperature to controlled ambient temperature conditions and stabilize the test item prior to proceeding to the appropriate procedure.

4.4.2 Procedure I - Shock from Constant Extreme Temperatures. (Figures 503.7-1 to -3)

The following procedure and its variations provide the basis for collecting the necessary information concerning materiel experiencing a severe temperature shock environment. The procedures depicted in figures 503.7-1 through 503.7-4 arbitrarily begin with the lower temperature, but could be reversed to begin with the higher temperature if it is more realistic.

NOTE: Unless the requirements documents indicate otherwise, if either of the following test procedure variations is interrupted because of work schedules, etc., maintaining the test item at the test temperature for the time required will facilitate completion of the test when resumed. If the temperature is changed, before continuing the test, restabilize the test item at the temperature of the last successfully completed period before the interruption. **Caution: When soaking at high temperature, e.g., overnight, ensure the total test time at the most severe temperature does not exceed the life expectancy of any material** (see Part One, paragraph 5.19).

The term "Cycle" means one shock in each direction, followed by temperature stabilization periods. T1 and T2 can be reversed based on the LCEP and application. Procedures I-A to I-D can be tailored to reflect one or more shocks to and from controlled ambient temperature conditions to hot or cold conditions. (See Procedure I-D and Figure 503.7-4.)

MIL-STD-810H
METHOD 503.7**4.4.2.1 Procedure I-A - One-way Shock(s) from Constant Extreme Temperature.**

- Step 1 With the test item in the chamber in its appropriate logistic configuration, adjust the chamber air temperature to the high or low temperature extreme specified in the test plan (T1) at a rate not to exceed 3 °C/min (5 °F/min). Stabilize the temperature for a period as determined in accordance with paragraph 2.3.5.
- Step 2 Transfer the test item in no more than one minute to an atmosphere at temperature (T2) that will produce the thermal shock specified in the test plan, and stabilize the temperature for a period as determined in accordance with paragraph 2.3.5.
- Step 3 If required in the test plan, evaluate the effects of the thermal shock on the test item to the extent practical.
- Step 4 If other one-way shocks are required, repeat Steps 1-3. Otherwise, return the test item to standard ambient conditions at a rate not to exceed 3 °C/min (5 °F/min).
- Step 5 Examine the test item and, if appropriate, perform an operational check. Record the results for comparison with pretest data. If the test item fails to operate as intended, see paragraph 5 for analysis of results.

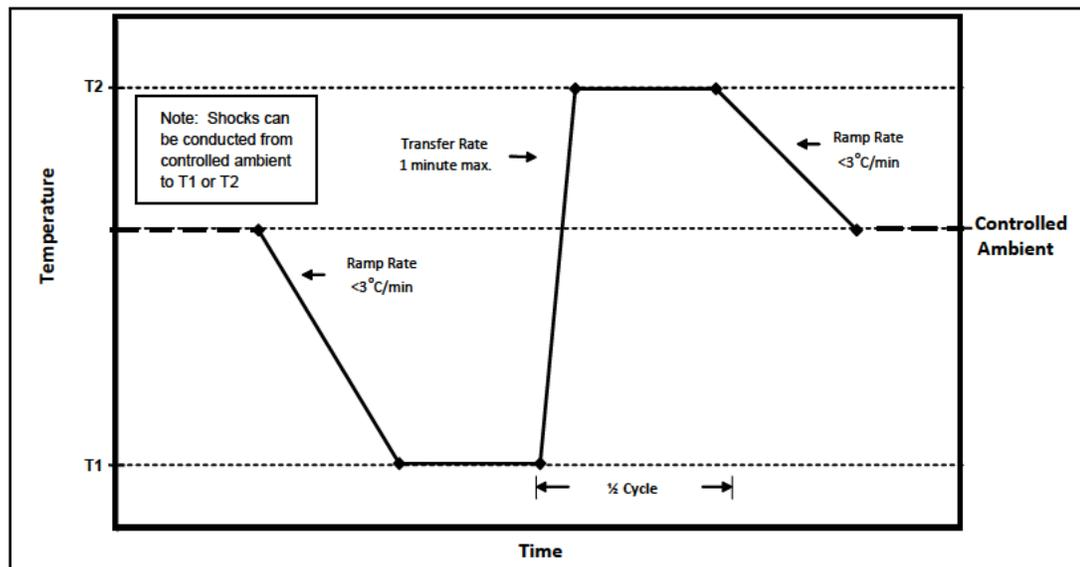


Figure 503.7-1. Single Shocks (1/2 cycle).

4.4.2.2 Procedure I-B - Single Cycle Shock from Constant Extreme Temperature.

- Step 1 With the test item in the chamber in its appropriate logistic configuration, adjust the chamber air temperature to the high or low temperature extreme specified in the test plan (T1) at a rate not to exceed 3 °C/min (5 °F/min). Stabilize the temperature for a period as determined in accordance with paragraph 2.3.5.
- Step 2 Transfer the test item in no more than one minute to an atmosphere at temperature (T2) that will produce the thermal shock specified in the test plan, and stabilize the temperature for a period as determined in accordance with paragraph 2.3.5.
- Step 3 If required in the test plan, evaluate the effects of the thermal shock on the test item to the extent practical.
- Step 4 Transfer the test item back to the T1 environment in no more than one minute. Stabilize the temperature for a period as determined in accordance with paragraph 2.3.5, and evaluate the thermal shock effects (if required).

MIL-STD-810H
METHOD 503.7

- Step 5 Return the test item to controlled ambient temperature conditions.
- Step 6 Examine the test item and, if appropriate, perform an operational check. Record the results for comparison with pretest data. If the test item fails to operate as intended, see paragraph 5 for analysis of results.

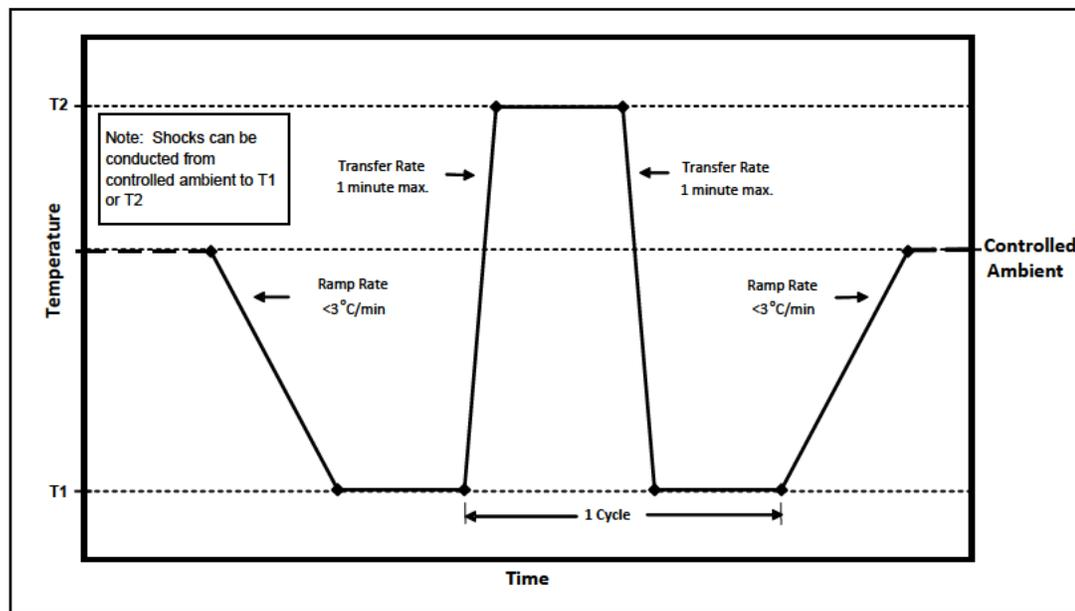


Figure 503.7-2. Single Cycle Shocks.

4.4.2.3 Procedure I-C - Multi-Cycle Shocks from Constant Extreme Temperature.

- Step 1 With the test item in the chamber in its appropriate logistic configuration, adjust the chamber air temperature to the high or low temperature extreme specified in the test plan (T1) at a rate not to exceed $3^{\circ}\text{C}/\text{min}$ ($5^{\circ}\text{F}/\text{min}$). Stabilize the temperature for a period as determined in accordance with paragraph 2.3.5.
- Step 2 Transfer the test item in no more than one minute to an atmosphere at temperature (T2) that will produce the thermal shock specified in the test plan, and stabilize the temperature for a period as determined in accordance with paragraph 2.3.5.
- Step 3 If required in the test plan, evaluate the effects of the thermal shock on the test item to the extent practical.
- Step 4 Transfer the test item back to the T1 environment in less than one minute. Stabilize the temperature for a period as determined in accordance with paragraph 2.3.5, and evaluate the thermal shock effects (if required).
- Step 5 Repeat steps 2-4 at least twice for a minimum of three cycles.
- Step 6 Return the test item to controlled ambient temperature conditions.
- Step 7 Examine the test item and, if appropriate, perform an operational check. Record the results for comparison with pretest data. If the test item fails to operate as intended, see paragraph 5 for failure analysis and follow the guidance in paragraph 4.3.2 for test item failure.

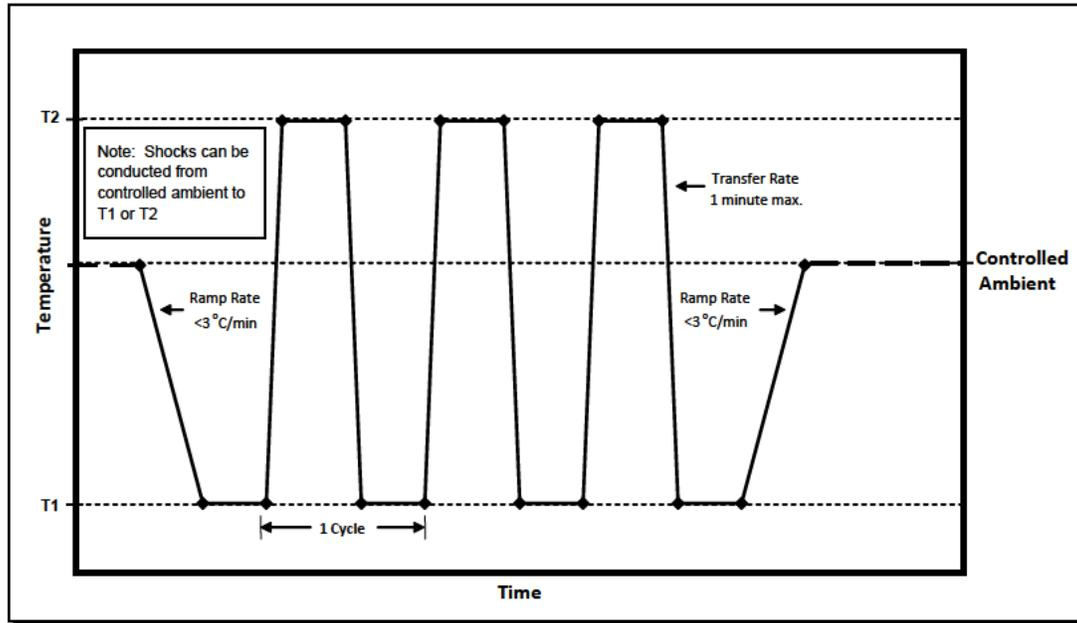
MIL-STD-810H
METHOD 503.7

Figure 503.7-3. Multi-cycle Shocks.

4.4.2.4 Procedure I-D - Shocks To or From Controlled Ambient Temperature. (Figure 503.7-4)

NOTE: This procedural variation always starts at controlled ambient temperature conditions, but can be tailored to follow any of the three above variations, i.e., a single shock, a single cycle, or multiple cycles.

- Step 1 With the test item in its appropriate logistic configuration, stabilize the test item at controlled ambient temperature conditions. (Part One, paragraph 5.1).
- Step 2 Transfer the test item in no more than one minute to an atmosphere at temperature T1 or T2 that will produce the thermal shock specified in the test plan, and stabilize the temperature for a period as determined in accordance with paragraph 2.3.5.
- Step 3 Transfer the test item to controlled ambient temperature conditions in no more than one minute, and stabilize the temperature for a period as determined in accordance with paragraph 2.3.5.
- Step 4 If required in the test plan, evaluate the effects of the thermal shock on the test item to the extent practical.
- Step 5 Either tailor additional shocks by repeating steps 1-4, or proceed to Step 6.
- Step 6 After all required shocks are completed, examine the test item and, if appropriate, perform an operational check. Record the results for comparison with pretest data. If the test item fails to operate as intended, see paragraph 5 for analysis of results.

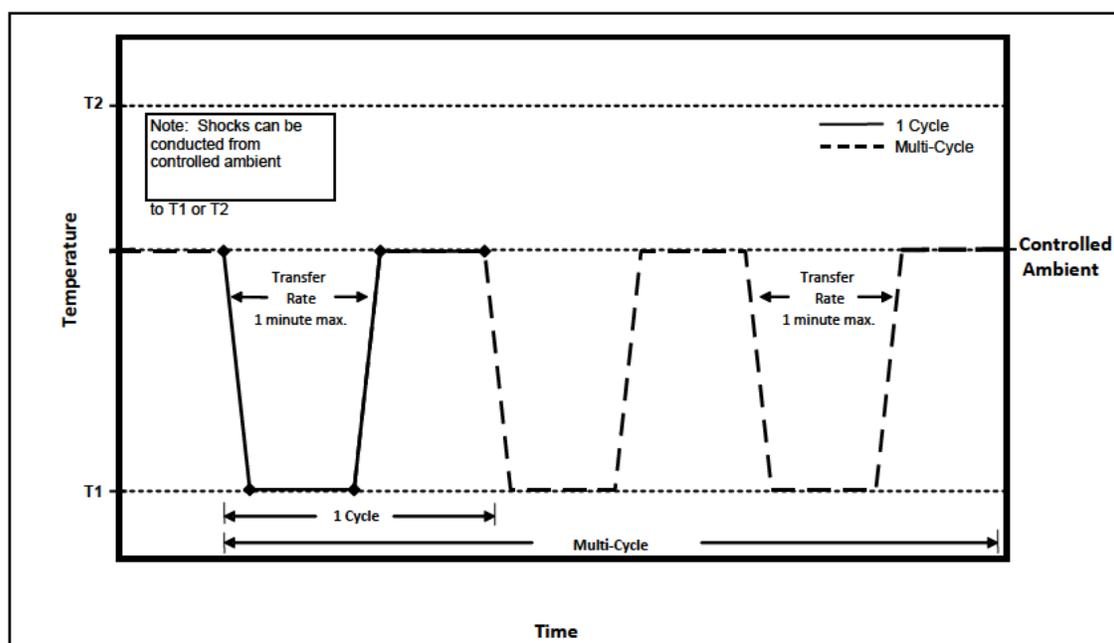
MIL-STD-810H
METHOD 503.7

Figure 503.7-4. Shocks to & from Controlled Ambient.

5. ANALYSIS OF RESULTS.

Follow the guidance provided in Part One, paragraph 5.14 and 5.17 to assist in the evaluation of the test results. Analyze any failure of a test item to meet the requirements of the materiel specifications. For premature failures other than those described in paragraph 4.3 above, see Part One, paragraph 4.2.2.5 and Task 406 (Environmental Test Report), paragraph 406.2.2.

6. REFERENCE/RELATED DOCUMENTS.

6.1 Referenced Documents.

- a. MIL-HDBK-310, Global Climatic Data for Developing Military Products.
- b. AR 70-38, Research, Development, Test and Evaluation of Materiel for Extreme Climatic Conditions.
- c. MIL-STD-2105C, Test Method Standard – Hazard Assessment Tests for Non-Nuclear Munitions.
- d. Krause, P.F. (1980). Natural Environmental Testing Criteria and Recommended Test Methodologies for a Proposed Standard for National Weather Service Equipment. (Work Unit No. 10R01MGIS12). Contract performed for the National Weather Service. Fort Belvoir, VA: US Army Engineer Topographic Laboratories.

6.2 Related Documents.

- a. NATO STANAG 4370, Environmental Testing.
- b. Allied Environmental Conditions and Test Publication (AECTP) 300, Climatic Environmental Tests (under STANAG 4370), Method 304.
- c. NATO STANAG 4370, Allied Environmental Conditions and Test Publication (AECTP) 230, Climatic Conditions.
- d. Synopsis of Background Material for MIL-STD-210B, Climatic Extreme for Military Equipment. Bedford, MA: Air Force Cambridge Research Laboratories, January 1974. DTIC number AD-780-508.

MIL-STD-810H
METHOD 503.7

- e. Egbert, Herbert W. "The History and Rationale of MIL-STD-810 (Edition 2)," January 2010; Institute of Environmental Sciences and Technology, Arlington Place One, 2340 S. Arlington Heights Road, Suite 100, Arlington Heights, IL 60005-4516.

(Copies of Department of Defense Specifications, Standards, and Handbooks, and International Standardization Agreements are available online at <https://assist.dla.mil>.)

Requests for other defense-related technical publications may be directed to the Defense Technical Information Center (DTIC), ATTN: DTIC-BR, Suite 0944, 8725 John J. Kingman Road, Fort Belvoir VA 22060-6218, 1-800-225-3842 (Assistance--selection 3, option 2), <http://www.dtic.mil/dtic/>; and the National Technical Information Service (NTIS), Springfield VA 22161, 1-800-553-NTIS (6847), <http://www.ntis.gov/>.

MIL-STD-810H
METHOD 503.7

(This page is intentionally blank.)

MIL-STD-810H
METHOD 504.3

METHOD 504.3
CONTAMINATION BY FLUIDS
CONTENTS

1. SCOPE.....	1
1.1 PURPOSE.....	1
1.2 APPLICATION.....	1
1.3 LIMITATIONS.....	1
2. TAILORING GUIDANCE.....	1
2.1 SELECTING THE CONTAMINATION BY FLUIDS METHOD.....	1
2.1.1 EFFECTS OF THE CONTAMINATING FLUIDS ENVIRONMENT.....	1
2.1.2 SEQUENCE AMONG OTHER METHODS.....	2
2.2 DIFFERENCE BETWEEN PROCEDURES.....	2
2.2.1 LENGTH OF EXPOSURE.....	2
2.2.2 CONTAMINANT FLUID GROUPS.....	2
2.2.3 TEST FLUID(S).....	4
2.2.4 COMBINATION OF TEST FLUIDS.....	4
2.2.5 TEST TEMPERATURE.....	4
2.2.6 FLUID EXPOSURE DURATION.....	5
2.2.7 METHODS OF APPLICATION.....	5
3. INFORMATION REQUIRED.....	5
3.1 PRETEST.....	5
3.2 DURING TEST.....	6
3.3 POST TEST.....	6
4. TEST PROCESS.....	6
4.1 TEST FACILITY.....	6
4.2 CONTROLS.....	6
4.3 TEST INTERRUPTION.....	6
4.3.1 INTERRUPTION DUE TO CHAMBER MALFUNCTION.....	6
4.3.2 INTERRUPTION DUE TO TEST ITEM OPERATION FAILURE.....	7
4.4 TEST SETUP.....	7
4.5 TEST EXECUTION.....	7
4.5.1 PRELIMINARY STEPS.....	7
4.5.2 PRETEST STANDARD AMBIENT CHECKOUT.....	7
4.5.3 CLEANING.....	7
4.5.4 MULTIPLE FLUIDS.....	7
4.5.5 PROCEDURE I.....	8
5. ANALYSIS OF RESULTS.....	9
6. REFERENCE/RELATED DOCUMENTS.....	9
6.1 REFERENCED DOCUMENTS.....	9
6.2 RELATED DOCUMENTS.....	10

MIL-STD-810H
METHOD 504.3

CONTENTS - Continued

TABLES

TABLE 504.3-I GENERAL TEST FLUIDS.....3

**METHOD 504.3 ANNEX A
ENVIRONMENTAL AND TOXICOLOGICAL CONSIDERATIONS**

1. GASOLINE FUELS AND MINERAL/SYNTHETIC OILS..... A-1
2. SOLVENTS AND CLEANING FLUIDS..... A-1
3. DEICING AND ANTIFREEZE FLUIDS..... A-1
4. DISINFECTANT. A-1
5. COOLANT DIELECTRIC FLUID..... A-1
6. INSECTICIDES..... A-1

**METHOD 504.3 ANNEX B
GENERAL FLUID INFORMATION**

CONTAMINANT FLUID GROUPS.B-1

**METHOD 504.3 ANNEX C
HANDLING, DISPOSAL OF CHEMICALS, AND THE DECONTAMINATION OF TEST EQUIPMENT
AND TEST ITEMS AFTER EXPOSURE TO CHEMICALS**

GUIDANCE. C-1

MIL-STD-810H
METHOD 504.3

METHOD 504.3 CONTAMINATION BY FLUIDS

NOTE: Tailoring is essential. Select methods, procedures, and parameter levels based on the tailoring process described in Part One, Paragraph 4.2.2, and Annex C. Apply the general guidelines for laboratory test methods described in Part One, paragraph 5 of this standard.

1. SCOPE.

1.1 Purpose.

Use contamination by fluids tests to determine if materiel (or material samples) is affected by temporary exposure to contaminating fluids (liquids) such as may be encountered and applied during its life cycle, either occasionally^{1/}, intermittently^{2/}, or over extended periods^{3/}.

1.2 Application.

The procedure described in this Method is used when there is a high probability of fluid contamination during the life cycle of the materiel. Contamination may arise from exposure to, but not limited to fuels, hydraulic fluids, lubricating oils, solvents and cleaning fluids, de-icing and anti-freeze fluids, runway deicers, insecticides, disinfectants, coolant dielectric fluid, and fire extinguishants.

WARNING: THIS METHOD REQUIRES THE USE OF SUBSTANCES AND/OR TEST PROCEDURES THAT MAY HAVE AN ENVIRONMENTAL IMPACT OR BE INJURIOUS TO HEALTH, IF ADEQUATE PRECAUTIONS ARE NOT TAKEN. ADDITIONAL INFORMATION IS PROVIDED IN ANNEX A. REFER TO THE SUPPLIER'S SAFETY DATA SHEET (SDS) OR EQUIVALENT FOR CHEMICAL COMPATIBILITY AND HEALTH HAZARD DATA ON THE VARIOUS CHEMICALS USED, AND COORDINATE WITH LOCAL ENVIRONMENTAL AUTHORITIES. ENSURE ALL POST-TEST MATERIALS ARE DISPOSED OF IN ACCORDANCE WITH LOCAL, STATE AND FEDERAL REGULATIONS.

1.3 Limitations.

This test is not intended to demonstrate the suitability of materiel to perform during continuous contact with a fluid; e.g., an immersed fuel pump, nor should it be used to demonstrate resistance to electrolytic corrosion or corrosion due to human perspiration.

2. TAILORING GUIDANCE.

2.1 Selecting the Contamination by Fluids Method.

After examining requirements documents and applying the tailoring process in Part One of this Standard to determine where exposure to contaminating fluids is foreseen in the life cycle of the test item, use the following to confirm the need for this Method and to place it in sequence with other methods.

2.1.1 Effects of the Contaminating Fluids Environment.

During its life cycle, materiel may be accidentally or intentionally exposed to one or more fluids that could have an adverse effect on the materiel. As a result, exposure of materiel to contaminating fluids may either temporarily or permanently impair the operation of the materiel by changing the physical properties of the material(s) composing it. Consider the following typical examples of problems to help determine if this Method is appropriate for the materiel being tested. The list is not intended to be all-inclusive and some of the examples may overlap.

a. Physical.

- (1) Shattering of glass vials and optical materiel.
- (2) Binding or slackening of moving parts.
- (3) Cracking of solid pellets or grains in explosives.
- (4) Differential contraction or expansion rates or induced strain rates of dissimilar materials.

^{1/} Extraordinary/unusual circumstances occurring once or twice a year.

^{2/} Regular basis under normal operation; possibly seasonally over the life of the materiel.

^{3/} Long periods such that materiel is thoroughly exposed.

MIL-STD-810H
METHOD 504.3

- (5) Deformation or fracture of components. (Solder reflow is the worst case.)
 - (6) Cracking of surface coatings.
 - (7) Seal or gasket failures (leaking of sealed compartments).
 - (8) Failure of insulation protection.
 - (9) Condensation of water onto cold surfaces suddenly exposed to higher ambient temperatures at "high relative humidity" - can cause frosting on optical surfaces - can cause corrosion on vulnerable surfaces.
 - (10) Differential contraction or expansion rates or induced strain rates between surface and interior portions of thermally massive constructs.
 - (11) Packaging failure.
 - (12) Crazeing or swelling of plastics and rubbers.
 - (13) Adhesion failures (delamination).
 - (14) Paint/legend removal.
- b. Chemical.
- (1) Separation of constituents.
 - (2) Failure of chemical agent protection.
 - (3) Leeching of antioxidants and other soluble materials.
 - (4) Corrosion.
 - (5) Melting or decomposition.
- c. Electrical.
- (1) Changes in electrical and electronic components.
 - (2) Electronic or mechanical failures due to rapid water or frost formation.
 - (3) Excessive static electricity.
 - (4) Interruption of electrical continuity (such as "grounding" fingers on EMI strips).
 - (5) Increase in electrical resistance due to thermo-mechanical "fretting corrosion."

2.1.2 Sequence Among Other Methods.

- a. General. Use the anticipated life cycle sequence of events as a general sequence guide (see Part One, paragraph 5.5).
- b. Unique to this Method. Do not perform these tests prior to other climatic environmental tests because of potential effect of the contaminants or their removal by decontaminants.

2.2 Difference Between Exposures.

This Method has one procedure, three exposures.

- a. Occasional Contamination
- b. Intermittent Contamination
- c. Extended Contamination

2.2.1 Duration of Exposure.

There are three options provided in Procedure I; occasional, intermittent, and extended contamination (paragraph 1.1). From the requirements document, determine the option to be used based on the anticipated life cycle scenario, along with the order of application of the test fluids if more than one is required.

2.2.2 Contaminant Fluid Groups.

The groups of fluids are listed in Table 504.3-I (see paragraph 6.1, reference s), (see paragraph 6.1, reference t) and described in Annex B. These lists are not all inclusive and allow the addition of other fluids as called out in the test requirements.

MIL-STD-810H
METHOD 504.3

Table 504.3-I. General test fluids.

CHEMICAL ¹	SOURCE DOCUMENT	POSSIBLE USES
1. Cleaning compound, solvent (Rifle bore cleaner)	MIL-PRF-372	Small arms, textiles, general
2. Degreasing Solvent Naphtha or Stoddard, dry cleaning, or D-Limonene solvent	MIL-PRF-680 (NATO #S-752, S-753, S-760)	Small arms, textiles, general, helicopters (parts)
3. Engine oil	MIL-PRF-2104, (NATO #O-1236/15W40), 40, 30 (NATO O-238), 10W, 10W (NATO O-237, SCPL (equipment specific)	Small arms, textiles, general
4. Lubricant, semi-fluid, automatic weapons	MIL-L-46000 (NATO #O-158)	Small arms, textiles, general
5. Lubricating oil, general purpose, preservative (water displacing, low temperature)	MIL-PRF-32033 (NATO #O-190)	Small arms, textiles, general
6. Lubricant, cleaner, and preservative	MIL-L-63460 (CLP), (NATO #S-758)	Small arms, textiles, general
7. Gasoline, commercial, or combat	ASTM D910, Aviation Gasoline; ASTM D4814, Automotive spark ignition engine (Commercial and MOGAS) and others as indicated by test requirements.	Small arms, textiles, general
8. Aviation Turbine fuels, kerosene types	Aviation turbine fuel JP-8 (NATO F-34); NATO Grade F-24, ASTM D1655; Commercial fuel, Jet A, Jet A-1 and others as indicated by test requirements.	Small arms, textiles, general, helicopters (parts)
9. Diesel Fuel, (DL-1, DL-2, other Grades)	A-A-52557, /ASTM D975, (NATO #F-54)	Small arms, textiles, general
10. Insect repellent, personal application	NSN 6840-01-284-3982, Crème, approx 32% Deet	Small arms, textiles, general
11. Dexron III [®]	NSN 9150-00-698-2382, Automatic Transmission Fluid, Commercial	Small arms, textiles, general
12. Antifreeze, Multi Engine Type, ethylene (I) or propylene glycol (II)	A-A-52624, /ASTM D6210 Type I, ASTM D6211 Type II) (NATO #S-750)	Small arms, textiles, general
13. Water	Water (distilled). Used as baseline where applicable.	Small arms, textiles, general
14. Simulated sea water or 5% NaCl	ASTM D1141 or ASTM B117	Small arms, textiles, general
15. Decontaminating agent STB	MIL-DTL-12468	Small arms, textiles, general
16. Lubricating oil, weapons, low temperature	MIL-PRF-14107 (LAW), (NATO #O-157)	Small arms, textiles, general
17. Hydraulic fluid, synthetic hydrocarbon base, aircraft, missile, & ordnance (OHA), others as indicated by test requirements.	MIL-PRF-87257 (NATO #H-538) or MIL-PRF-83282 (NATO #H-537)	Small arms, textiles, general, helicopters (parts)
18. Hydraulic fluid, rust inhibited, phosphate based synthetic hydrocarbon, fire-resistant	MIL-PRF-46170 (FRH, (NATO #H-544)	Small arms, textiles, general
19. Hydraulic fluid, petroleum based for preservation and operation (OHT)	MIL-PRF-6083, (NATO # C635)	Small arms, textiles, general
20. DS-200 Decontaminating Agent	NSN 6850-01-501-1044, Peroxide based	Small arms, textiles, general
21. Lubricating Oils Synthetic, Aircraft turbine engines, transmissions	MIL-PRF-23699, NATO # O-156; MIL-PRF-7808 (NATO O-152, O-154, O-156, O-167)	Aircraft (parts)
22. De-icers, Anti-Icing	Deicers-Aircraft: Ethylene or propylene glycol mixtures; US antifreeze: AA-52624A (NATO S-750), and others as indicated by test requirements.	Aircraft
23. Silicone based damping fluid (various viscosities, cSts)	Dimethyl silicone (NATO S-1714)	

MIL-STD-810H
METHOD 504.3**Table 504.3-I. General test fluids.**

CHEMICAL ¹	SOURCE DOCUMENT	POSSIBLE USES
24. Aircraft Cleaners, Aerospace, Ground Equipment/Aircraft Interior/Exterior	MIL-PRF 87937, /MIL-PRF-85570, MIL-C-87936, MIL-PRF-85704 or others as indicated	Aircraft (parts)
25. Other Solvents	Denatured or Isopropyl alcohol (2-propanol), acetone, etc.	Small arms, textiles, general, Aircraft (parts)
26. Deicing & antifreeze fluids	Deicers-Aircraft: Ethylene or propylene glycol mixtures; US antifreeze: AA-52624 (NATO S-750), and others as indicated by test requirements.	Aircraft (parts)
27. Runway deicers	Potassium-acetate based solution (i.e., Cryotech E-36 or other as indicated by test requirements).	Aircraft (parts)
28. Insecticides	Insecticides (i.e., Malathion or pyrethrin) as indicated by test requirements).	Aircraft (parts)
29. Disinfectant (Heavy duty phenolics)	Clear, soluble phenolics, e.g., phenol or its derivatives dissolved in a surfactant and diluted with water to give a clear solution; Parachlorometaxylenol (i.e., EcoTru-1453, Aircraft Disinfectant or others as indicated by test requirements.	Aircraft (parts)
30. Coolant dielectric fluid	Polyalphaolefin (PAO) dielectric	Aircraft (parts)

¹ **NOTE:** The chemical list shows the more common chemicals used in Military applications and is not all inclusive. Some chemicals may not be readily available and therefore, substitutions may be made through agreement of Test Proponent and the laboratory performing the test. Also, new chemicals may be introduced after publication of this document or are specific to the test item. In this case, these can be added by the Test Proponent

2.2.3 Test Fluid(s).

Select the test fluid(s) from those listed in Tables 504.3-I, (as determined by tailoring procedures), that are representative of those commonly encountered during the life cycle. In the requirements document, list all other fluids identified during the tailoring process as possible contaminants (see 504.3-I, Note 1). Service grades of fluids may be changed or modified with development formulations and materiel demands. Some may subsequently be found undesirable because of environmental or health and safety problems.

2.2.4 Combination of Test Fluids^{4/}.

When more than one test fluid is to be applied, consider the following:

- the need to assess the effect of the fluids individually, combined, or in succession.
- the potential problem of identifying which fluid or combination of fluids affected the test item.
- if the order of exposure to fluids in service is known, or if the order of exposure to fluids recognized as having synergistic effects is known and is realistic in service, specify this order.
- if there is a requirement to clean the test item between or after tests, or if a new test item is to be used for each test fluid. Do not use a cleaning fluid that results in further contamination. Some of the specified test fluids may be used as cleaning fluids (e.g., aviation fuel, solvents, etc...), otherwise use a fluid known to be used in normal cleaning procedures.

2.2.5 Test Temperature.

Unless otherwise required by the customer, this test is performed with both the fluids and the test item at standard ambient conditions. Where appropriate, use temperatures representative of the actual conditions under which fluid contamination can occur, either intentionally or accidentally (see paragraphs 2.2.5.1 – 2.2.5.3). The application of

^{4/} When mixing two or more fluids, ensure they are compatible and will not produce hazardous reactions.

MIL-STD-810H
METHOD 504.3

contaminating fluids could result in thermal shock as well as contamination effects. Ensure the temperatures used do not exceed the operation/storage temperatures of the test item, therefore incurring possible damage from over temperatures.

2.2.5.1 Test Item Temperature.

Unless otherwise required by the customer, the test fluids are stabilized at standard ambient conditions. Where appropriate, use a test item temperature representative of the materiel temperature when exposed to the contaminating fluid. For example, materiel to be de-iced will most likely be at or below freezing; materiel exposed to hydraulic leaks while on the tarmac may have surface temperatures higher than 50 °C (122 °F).

2.2.5.2 Test Fluid Temperature.

Unless otherwise required by the customer, the test items are stabilized at standard ambient conditions. Where appropriate, use the temperature of the test fluid equal to its temperature during its most extreme operating condition. Design assessment may prove that other temperatures provide a more severe environment, e.g., longer exposure at lower temperatures because of slower evaporation.

2.2.5.3 Soak Temperature.

If testing at other than standard ambient conditions and in order for contamination effects to mature, a temperature soak of the test item following contamination may be necessary. The temperature of both the contaminating fluid and the materiel will, most likely, change during actual contamination situations. The post-contamination temperature soak will not necessarily reflect the exposure scenario, but rather the worst-case effect(s) on the materiel. Accordingly, for the soak temperature, use the materiel's maximum life cycle temperature for the anticipated exposure situation.

2.2.6 Fluid Exposure Duration.

- a. Occasional Exposure. Item is exposed to chemical for 5 to 10 minutes. If other than standard ambient temperature is used for the item temperature, maintain this temperature for 8 hours and then bring the item to standard ambient temperature.
- b. Intermittent Exposure. Item is exposed to chemical for 8 hours continuous contact and then left to air dry for 16 +1 hr at standard ambient conditions.
- c. Extended Contamination. Item is exposed to chemical for at least 24 hours (unless otherwise specified in test document) continuous contact. If other than standard ambient temperature is used for the item temperature, maintain this temperature for 8 hours and then bring the item to standard ambient temperature.

2.2.7 Methods of Application.

The solutions/chemicals can be applied by immersing, spraying, brushing, or as stated in the test requirements.

3. INFORMATION REQUIRED.

3.1 Pretest.

The following information is required to conduct contamination by fluid tests adequately.

- a. General. Information listed in Part One, paragraphs 5.7 and 5.9, and Annex A, Task 405 of this Standard.
- b. Specific to this Method.
 - (1) List of the test fluid(s) to be used
 - (2) The method of test fluid application. (See paragraph 4.1.)
 - (3) The soak (post-wetting) temperature and duration.
 - (4) The cleaning/decontaminating fluids.
 - (5) The sequence of test fluid applications and post-test cleaning instructions.
 - (6) The type of exposure, i.e., occasional, intermittent, or extended.
 - (7) Any requirement for long term surveillance and inspections.
 - (8) Material properties, e.g., tensile strength, hardness, weight, dimensions, protective finish, etc., of the material likely to be affected by the contaminating fluids.
 - (9) Record of initial baseline information with digital photography.
 - (10) Record of test item and test fluid temperature.

MIL-STD-810H
METHOD 504.3

- c. Tailoring. Necessary variations in the basic test procedures to accommodate environments identified in the LCEP.

3.2 During Test.

Collect the following information as appropriate during conduct of the test:

- a. General. Information listed in Part One, paragraph 5.10, and in Annex A, Tasks 405 and 406 of this Standard.
- b. Specific to this Method.
- (1) Record of chamber and test item temperature versus time conditions.
 - (2) Test fluid(s) and the corresponding temperature.
 - (3) Any deterioration noted during visual checks.

3.3 Post Test.

The following post test data shall be included in the test report.

- a. General. Information listed in Part One, paragraph 5.13, and in Annex A, Task 406 of this Standard.
- b. Specific to this Method.
- (1) Results of each functional check after each exposure to each of the specified fluids.
 - (2) Any degradation of materials, protective finishes, etc. (see paragraph 3.1b(8)).
 - (3) Exposure durations and types.
 - (4) Any deviation from the original test plan.
 - (5) Record degradation with digital photography.

4. TEST PROCESS.

4.1 Test Facility.

Use a test facility that includes an enclosure and a temperature control mechanism designed to maintain the test item at a specified temperature, as well as a means of monitoring the prescribed conditions (see Part One, paragraph 5.18). The contamination facility is a tank or other container within the test enclosure (non-reactive with the contaminant) in which the test item is exposed to the selected contaminant by immersion, spraying, or brushing. When the flash point of the test fluid is lower than the test temperature, design the test facility in accordance with fire and explosion standards.

4.2 Controls.

Record chamber and, if required, test item and test fluid temperatures in accordance with Part One, paragraphs 5.2 and 5.18, at a sufficient rate to satisfy the post-test analysis (see Part One, paragraph 5.18).

Ensure the test and cleaning (decontaminating) fluids are handled and disposed of as required by local environmental and safety requirements. Some test fluid specifications are referenced in Table 504.3-I.

4.3 Test Interruption.

Test interruptions can result from two or more situations, one being from malfunction of test chambers or associated test laboratory equipment. The second type of test interruption results from failure or malfunction of the test item itself during performance checks (required or optional).

4.3.1 Interruption Due to Chamber Malfunction.

- a. General. See Part One, paragraph 5.11 of this Standard.
- b. Specific to this Method.
- (1) Undertest interruption. If an unscheduled test interruption occurs that causes the test conditions to exceed allowable tolerances toward standard ambient conditions, give the test item a complete visual examination and develop a technical evaluation of the impact of the interruption on the test results. Restart the test at the point of interruption and re-stabilize the test item at the test conditions.
 - (2) Overtest interruption. If an unscheduled test interruption occurs that causes the test conditions to exceed allowable tolerances away from standard ambient conditions, stabilize the test conditions to within tolerances and hold them at that level until a complete visual examination and technical evaluation can be made to determine the impact of the interruption on test results. If the visual examination or technical evaluation results in a conclusion that the test interruption did not adversely affect the final test results, or if the effects of the interruption can be nullified with confidence, re-

MIL-STD-810H
METHOD 504.3

stabilize the pre-interruption conditions and continue the test from the point where the test tolerances were exceeded. Otherwise, see paragraph 4.3.2 for test item operational failure guidance.

4.3.2 Interruption Due to Test Item Operation Failure.

Failure of the test item(s) to function as required during required or optional performance checks during testing presents a situation with several possible options. See Part One, paragraph 5.11 of this Standard.

- a. The preferable option is to replace the test item with a “new” one and restart from Step 1.
- b. A second option is to replace / repair the failed or non-functioning component or assembly with one that functions as intended, and restart the entire test from Step 1.

NOTE: When evaluating failure interruptions, consider prior testing on the same test item and consequences of such.

4.4 Test Setup.

- a. General. See Part One, paragraph 5.8.
- b. Unique to this Method. Ensure collection containers are available for each test fluid and waste fluids.

4.5 Test Execution.

The following test procedure may be used to determine the resistance or compatibility of the materiel to contaminating fluids. Conduct the functional checks after each exposure to each of the specified fluids.

4.5.1 Preliminary Steps.

Before starting any of the test procedures, determine the test details (e.g., procedure variations, test item configuration, contaminating fluids, durations, parameter levels, etc.) from the test plan. (See paragraph 3.1 above.)

4.5.2 Pretest Standard Ambient Checkout.

All test items require a pretest standard ambient checkout to provide baseline data. Examine munitions and other appropriate materiel by nondestructive examination methods. Conduct the checkout as follows:

- Step 1. Stabilize the test item at standard ambient conditions (Part One, paragraph 5.1).
- Step 2. Conduct a complete visual examination of the test item (evaluate against paragraph 2.1.1) with special attention to surface coatings and stress areas such as corners of molded areas and interfaces between different materials (e.g., component lead/ceramic interfaces of visible electronic parts), and document the results for comparison with post test data.
- Step 3. Conduct an operational checkout, where applicable, in accordance with the approved test plan and record the results for comparison with post test data. If the test item operates satisfactorily, proceed to the next Step. If not, resolve the problems and restart at Step 1, above. Where only parts are available, cut the part into appropriate sizes to accommodate all of the test fluids. Record any weight, hardness, or other physical data for each piece where appropriate.
- Step 4. Where applicable, prepare the test item in accordance with Part One, paragraph 5.8, and in the required test item configuration. Record initial baseline information with digital photography if available.

4.5.3 Cleaning.

If necessary and, unless otherwise specified, clean the test item to remove unrepresentative coatings or deposits of grease. Be careful to ensure the cleaning compound will not interfere with the test, i.e., by leaving a residue to interact with test chemicals.

4.5.4 Multiple Fluids.

If more than one contaminating fluid has been identified per test item, determine if each is to be evaluated simultaneously or sequentially. Where small items are used such as small arms ammunition, non-metallic materials, or pieces from a larger test item, use one test piece for each chemical. If sequential testing is required, specify in the requirements document any necessary cleaning method between tests for different contaminants. Check the supplier's material safety data sheet for chemical compatibility. Since contamination normally occurs with one fluid at a time, apply test fluids singly with appropriate cleaning of the specimen before applying subsequent fluids. If desired, clean the test item using a fluid listed as a 'contaminant' if its effect has been shown to be neutral, e.g., aviation fuel detergent.

MIL-STD-810H
METHOD 504.3

Consider the possibility of simultaneous contamination by two or more fluids, especially if the result is expected to be synergistically more severe. Also consider the possibility of synergistic action resulting from consecutive contamination. In these cases, do not clean the test item between the applications of test fluids.

WARNING: READ ALL PERTINENT SDS INFORMATION ON ANY CHEMICAL PRIOR TO ITS USE. ADDITIONALLY, USE APPROPRIATE PERSONAL PROTECTIVE EQUIPMENT.

4.5.5 Procedure

- Step 1. Select the appropriate chemicals/solutions as per the test directive (chemicals may or may not be listed in Table 504.3. Prepare the test items.⁵ If etching will not affect the test item, number the parts to help with identification. Record the test item nomenclature, serial or lot numbers, manufacturer, chemicals/solutions, and any other pertinent test data.
- Step 2. Stabilize the test item at the appropriate temperature for the identified contamination scenario (see paragraph 2.2.5).
- Step 3. Stabilize the temperature of the specified fluid(s) to that determined from paragraph 2.2.5.2. If simultaneous application of more than one fluid is required, apply the fluid with the highest application temperature first, then the next highest, and so on until all required fluids have been applied.⁶
- a. Occasional Contamination.
- (1) Apply the specified fluid(s) (e.g., immerse, dip, spray, etc.) to the entire surface of the test item that is likely to be exposed.
 - (2) Allow the test item to drain naturally for 5 to 10 minutes. Shaking or wiping is not permitted but, if representative of service conditions, it may be rotated about any axis to allow for drainage from different positions.
 - (3) Where applicable, maintain the test item at the temperature determined in paragraph 2.2.5.1 for eight hours (paragraph 2.2.6). Ramp the chamber to standard ambient temperature at a rate not to exceed 3°C/min (5°F/min) prior to removal of test item(s).
 - (4) Visually examine the test item for degradation of materials and surface finishes. Record any physical characteristics for comparison with previous results or if appropriate, conduct an operational check of the test item similar to that in paragraph 4.5.2, step 3, and document the results for comparison with the pretest data.
 - (5) Clean the test item with a known fluid that will not cause any changes to the test item (Annex C).

If testing sequentially, repeat steps a (1) through (4) for each specified fluid without cleaning between each chemical application.

- b. Intermittent Contamination^{7, 8}.
- (1) Apply the specified fluid(s) (e.g., immerse, dip, spray, etc.) to the entire surface of the test item that is likely to be exposed. After one hour, visually inspect the test item/s for deterioration including softening, color changes, cracking, or dissolving of the material into the solution. If deterioration is observed, remove that item from the fluid and report

^{5/} Items can be cut to size. The integrity of the samples must be taken into account. If using one test item, use different sections of the test item for each chemical unless stated otherwise in the test requirements document.

^{6/} When mixing two or more fluids, ensure they are compatible and will not produce hazardous reactions.

^{7/} Intermittent contamination is tailorable to any test item. The exposure times can be shortened or lengthened according to the test plan. Also, if required, temperatures of the solution and/or test item can be changed to meet the requirements.

^{8/} Intermittent contamination, see TOP 03-2-609 for additional details.

MIL-STD-810H
METHOD 504.3

the results after one hour. If no deterioration is observed, maintain surfaces in a wetted condition for a total of 8 hours followed by a drying period of 16 hours at the temperature specified in paragraph 2.2.5.1. If tested at other than standards ambient conditions, ramp the chamber to standard ambient temperature at a rate not to exceed 3C/min (5F/min) prior to removal of test item(s).

- (2) After 8 hrs of exposure to fluids, blot excess chemicals from the item, and inspect again for any type of chemical degradation of materials, surface finishes, and physical changes. After the drying period, record final measurements and weights, if any, and record final visual observations. Where applicable, maintain the test item at the temperature determined in paragraph 2.2.5.1 for eight hours (paragraph 2.2.6). Ramp the chamber to standard ambient temperature at a rate not to exceed 3C/min (5F/min) prior to removal of test item(s).
 - (3) If appropriate, conduct an operational check of the test item similar to that in paragraph 4.5.2, step 3, and document the results for comparison with the pretest data.
 - (4) Clean the test item with a known fluid that will not cause any changes to the test item. If testing sequentially, repeat steps b(1) through (4) for each specified fluid.
- c. Extended Contamination.
- (1) Immerse the test item in the specified fluid and maintain for the period specified in the requirements document. If not specified, immerse the test item for at least 24 hours.
 - (2) Remove the test item from the chemical and allow it to drain naturally for 5 to 10 minutes.
 - (3) Where applicable, place the test item in a chamber set at the temperature determined in paragraph 2.2.5.1 for eight hours (paragraph 2.2.6). Ramp the chamber to standard ambient temperature at a rate not to exceed 3C/min (5F/min) prior to removal of test item(s). Steps c (1) through (3) can be repeated if long term analysis is needed as per the test plan (record number of cycles performed).
 - (4) After all cycles have been performed, visually examine the test item for degradation of materials, protective finishes, and physical changes and if appropriate, conduct an operational check of the test item similar to that in paragraph 4.5.2, step 3, and document the results for comparison with the pretest data record results.
 - (5) If testing sequentially, repeat steps c (1) through (4) for each specified fluid.

5. ANALYSIS OF RESULTS.

In addition to the guidance provided in Part One, paragraphs 5.14 and 5.17, any contamination effects must be analyzed for their immediate or potential (long-term) effects on the proper functioning of the test item or safety during its life cycle. Satisfactory functioning immediately following this test is not the sole criterion for pass/fail.

6. REFERENCE/RELATED DOCUMENTS.

6.1 Referenced Documents.

- a. MIL-PRF-372, Cleaning Compound, Solvent (For Bore of Small Arms and Automatic Aircraft Weapons).
- b. MIL-PRF-680, Degreasing Solvent.
- c. MIL-PRF-2104, Lubricating Oil, Internal Combustion Engine, Combat/Tactical Service.
- d. MIL-L-46000-C, Lubricant, Semi-Fluid (Automatic Weapons).
- e. MIL-PRF-32033, Notice 1, Lubricating Oil, General Purpose, Preservative (Water-Displacing, Low Temperature);
- f. MIL-PRF-63460E, Amendment 3, Lubricant, Cleaner and Preservative for Weapons and Weapons Systems (Metric).
- g. ASTM D4814-13, Fuel, Automotive Spark-Ignition Engine.
- h. MIL-DTL-83133, Turbine Fuels, Aviation, Kerosene Types, NATO F-34(JP-8), NATO F-35, and NATO F-37 (JP-8 + 100).

MIL-STD-810H
METHOD 504.3

- i. A-A-52557A, Notice 1, Fuel Oil, Diesel; For Posts, Camps and Stations.
- j. ASTM D975, Oils, Diesel Fuel.
- k. A-A-52624A, Notice 1, Antifreeze, Multi Engine Type.
- l. ASTM D1141, Ocean Water, Substitute.
- m. MIL-DTL-12468, Decontaminating Agent, STB.
- n. MIL-PRF-14107, Lubricating Oil, Weapons, Low Temperature.
- o. MIL-PRF-5606H, Notice 1, Hydraulic Fluid, Petroleum Base, Aircraft; Missile and Ordnance; remain inactive for new design; however, documents valid for use.
- p. MIL-PRF-46170, Hydraulic Fluid, Rust Inhibited, Fire Resistant, Synthetic Hydrocarbon Base, NATO Code No. H-544.
- q. MIL-PRF-6083, Hydraulic Fluid, Petroleum Base, for Preservation and Operation.
- r. ASTM D910, Gasoline, Aviation.
- s. NATO STANAG 4370, Allied Environmental Conditions and Test Publication (AECTP) 300, Climatic Environmental Tests Method 314.
- t. Test Operations Procedure (TOP) 03-2-609, Chemical Compatibility of Non-metallic Materials Used in Small Arms Systems; USATEC, APG, MD 21005-5001. DTIC Acquisition No. A359425.
- u. MIL-PRF-23699F, Lubricating Oil, Aircraft Turbine Engine, Synthetic Base, NATO Code No. O-156.
- v. MIL-PRF-87937, Cleaning Compound, Aerospace Equipment.
- w. MIL-PRF-85570, Cleaning Compounds, Aircraft, Exterior.
- x. MIL-PRF-85704, Cleaning Compound, Turbine Engine Gas Path.

6.2 Related Documents.

- a. NATO STANAG 4370, Environmental Testing.
- b. Egbert, Herbert W. "The History and Rationale of MIL-STD-810 (Edition 2)," January 2010; Institute of Environmental Sciences and Technology, Arlington Place One, 2340 S. Arlington Heights Road, Suite 100, Arlington Heights, IL 60005-4516.
- c. Defence Standard 42-40, Foam Liquids, Fire Extinguishing (Concentrates, Foam, Fire Extinguishing), (UK Ministry of Defence).
- d. Defence Standard 68-161, Dispensers, Insecticide Aerosol Flying Insect Killer, (UK Ministry of Defence).
- e. BS 6580: 1992, Specification for Corrosion Inhibiting, Engine Coolant Concentrate ('Antifreeze'), British Standards Institute.
- f. Defence Standard 79-17, Compound, Cleaning, Foaming, for Aircraft Surfaces, (UK Ministry of Defence).

MIL-STD-810H
METHOD 504.3, ANNEX A

METHOD 504.3, ANNEX A
ENVIRONMENTAL AND TOXICOLOGICAL CONSIDERATIONS

1. GASOLINE FUELS AND MINERAL/SYNTHETIC OILS.

- a. Open burning will produce environmental pollution.
- b. Contact with the skin will promote de-fatting.
 - (1) Ignition under certain circumstances will cause explosion.
 - (2) Low flash point of gasoline (piston engine): -40 °C (-40 °F).
 - (3) Spillage can cause contamination of waterways and underground water supplies. Three hundred liters of gasoline has the capacity to produce a surface film over one square kilometer of still water.
 - (4) Carcinogenic chemicals such as benzene are present in fuels; oils often contain other toxic ingredients.
 - (5) Tri alkyl phosphate is a typical synthetic hydraulic oil. Spillage can cause toxic pollution of waterways and underground water supplies.

2. SOLVENTS AND CLEANING FLUIDS.

- a. Propan-2-ol is flammable.
 - (1) 1.1.1 Trichloroethane has been withdrawn from use because of its environmental impact when reacting with ozone. It is also believed to have mutagenic properties.
 - (2) Denatured alcohol is both toxic and flammable. It is a mixture containing approximately 95 percent ethyl alcohol, 5 percent methyl alcohol, and minor ingredients such as pyridine.
 - (3) Detergent made from biodegradable phosphates sodium sulfate and sodium carboxy methyl cellulose is a conventional laundry substance. Untreated discharge into waterways must be avoided.

3. DEICING AND ANTIFREEZE FLUIDS.

50 percent inhibited aqueous potassium acetate solution is commercially marketed and reputed to be a completely safe new alternative to the ethylene glycols. However, its interaction with aluminum alloys is less than satisfactory.

4. DISINFECTANT.

Phenol based disinfectants can blister the skin; if toxic, they may cause poisoning by absorption through the skin or by inhalation of the vapors. Undiluted forms of certain disinfectants may be flammable. Use expert commercial disposal companies to manage disposal of detergents. Small quantities may be flushed down the drain with copious quantities of water.

5. COOLANT DIELECTRIC FLUID.

The most recent coolants are based on polymerised alpha olefins that are both non-toxic and generally inert.

WARNING: READ ALL PERTINENT SDS INFORMATION ON ANY CHEMICAL PRIOR TO ITS USE. ADDITIONALLY, USE APPROPRIATE PERSONAL PROTECTIVE EQUIPMENT.

6. INSECTICIDES.

Most insecticides may be regarded as toxic to man. If the delivery vehicle for the insecticide is a kerosene-type (fuel/oil) spray or mist, many of the features identified under paragraph 1 above will also apply.

MIL-STD-810H
METHOD 504.3, ANNEX A

(This page is intentionally blank.)

MIL-STD-810H
METHOD 504.3, ANNEX B**METHOD 504.3, ANNEX B****GENERAL FLUID INFORMATION****CONTAMINANT FLUID GROUPS.** (See paragraph 2.2.3)

The following groups of fluids are listed in Table 504.3-I for Procedure I, and Table 504.3-II for Procedure II. These lists are not all inclusive, and allow the addition of other fluids as called out in the test requirements.

- a. **Fuels.** Fuels will, for the most part, be of the gasoline, diesel or kerosene type, and whereas the former may be expected to evaporate rapidly - possibly with few permanently harmful effects, the latter two - being more persistent - can be damaging to many elastomers, particularly at elevated temperatures. Paints and most plastics are normally not affected by fuels, but silicone resin bonded boards may tend to de-laminate after prolonged exposure. Some fuels may have additives to inhibit icing or to dissipate static charges. Where there is reason to believe that these additives may increase the severity of the test, include them in the test fluids.
- b. **Hydraulic Fluids.** Commonly used hydraulic fluids may be of the mineral oil or ester-based synthetic type. The latter are damaging to most elastomers and to plastics; phosphate esters are especially damaging to these materials and to paint finishes.
- c. **Lubricating Oils.** Mineral or synthetic-based lubricating oils may be at elevated temperatures in their working states. Mineral oil is damaging to natural rubber but less so to synthetics such as polychloroprene, chloro-sulphonated polyethylene, and silicone rubber. Synthetic lubricants are extremely damaging to plastics such as PVC, as well as to many elastomers.
- d. **Solvents and Cleaning Fluids.** Many areas of aircraft or vehicles may require dirt or grease removal before servicing can begin. The fluids given in Table 504.3-I are representative of those presently in use.
- e. **Deicing and Antifreeze Fluids.** These fluids may be applied, often at elevated temperatures, to the leading edges, intakes, etc., of aircraft and may penetrate areas where they can contaminate components and materiel. These fluids are based, typically, on inhibited ethylene glycols.
- f. **Runaway Deicers.** These fluids are used on runways and other areas to lower the freezing point of water. They may penetrate the undercarriage and equipment bays of aircraft as a fine mist.
- g. **Insecticides.** Aircraft flying in and through the tropics may be treated with insecticide sprays as a routine precaution. While it is unlikely that these will have a direct adverse effect on materiel, it may be necessary to make exploratory tests using a proprietary insecticide.
- h. **Disinfectants.** The primary contaminating agent is likely to be the disinfectant used, that will be a formaldehyde/phenol preparation, and its use on waste liquid in/from galleys and toilet compartments, where a leak may permit contamination of materiel below the leak.
- i. **Coolant Dielectric Fluids.** These are used as thermal transfer liquids to assist cooling of certain equipment. They are usually based on silicate ester materials, and their effects on materials may be considered to be similar to the phosphate ester hydraulic fluids, although not quite as severe.
- j. **Fire Extinguishants.** Many HALON extinguishing agents have been or are being banned in many countries. Although HALON 1301 is still in some legacy systems, the extinguishing agents replacing some older chemical compounds are FE25, FM200, CO₂ ABC extinguishers, and newer types such as FE13. Fire fighting aqueous foams such as FFFP (Protein/Fluorprotein foams) have been replaced with AFFF (Aqueous Film-Forming Foam). The necessity for testing with these products is based on the need to maintain equipment functioning after release of the extinguishant.

MIL-STD-810H
METHOD 504.3, ANNEX B

(This page is intentionally blank.)

MIL-STD-810H
METHOD 504.3, ANNEX C

METHOD 504.3, ANNEX C

**HANDLING, DISPOSAL OF CHEMICALS, AND THE DECONTAMINATION OF TEST EQUIPMENT
AND TEST ITEMS AFTER EXPOSURE TO CHEMICALS**

Decontamination of test equipment, materials, and test items that have been subjected to a contamination by fluids (chemical compatibility) test is paramount when the test items are to be sent back to the users, manufacturer, or material management office for further evaluation or reuse. Many test items are too expensive to scrap and must be decontaminated.

- a. Always read the related SDS information for each chemical before use and during disposal. Personal protective equipment (PPE) such as gloves and safety glasses should be worn during handling of the chemicals and be familiar with the information found in the test site Chemical Hygiene Plan where applicable.
- b. Follow all Federal, State, and Local regulations for disposing of the chemicals after testing.
- c. Removing excess chemicals is necessary for safety to the user. Any residual chemical can be wiped with paper towels, rags or other soft cloth. The rags should be rung free of excess chemicals before being placed in a plastic bag and disposed of in accordance with Federal, State, and Local regulations.

MIL-STD-810H
METHOD 504.3, ANNEX C

(This page is intentionally blank.)

MIL-STD-810H
METHOD 505.7**METHOD 505.7**
SOLAR RADIATION (SUNSHINE)**CONTENTS**

<u>Paragraph</u>	<u>Page</u>
1. SCOPE.....	1
1.1 PURPOSE.....	1
1.2 APPLICATION.....	1
1.3 LIMITATIONS.....	1
2. TAILORING GUIDANCE.....	1
2.1 SELECTING THIS METHOD.....	1
2.1.1 EFFECTS OF SOLAR RADIATION ENVIRONMENTS.....	1
2.1.1.1 HEATING EFFECTS.....	1
2.1.1.2 ACTINIC EFFECTS.....	2
2.1.2 SEQUENCE AMONG OTHER METHODS.....	2
2.2 SELECTING PROCEDURES.....	2
2.2.1 PROCEDURE SELECTION CONSIDERATIONS.....	2
2.2.2 DIFFERENCE BETWEEN PROCEDURES.....	3
2.3 DETERMINE TEST LEVELS AND CONDITIONS.....	6
2.3.1 CLIMATIC CONDITIONS.....	6
2.3.2 TEST DURATION.....	6
2.3.3 HUMIDITY.....	6
2.3.4 CONFIGURATION.....	7
2.3.5 SPECTRAL POWER DISTRIBUTION - SEA LEVEL VERSUS HIGH GROUND ELEVATIONS.....	7
2.3.6 TEMPERATURE.....	7
2.3.7 AIRFLOW.....	7
2.4 TEST ITEM OPERATION.....	8
3. INFORMATION REQUIRED.....	8
3.1 PRETEST.....	8
3.2 DURING TEST.....	8
3.3 POST-TEST.....	9
4. TEST PROCESS.....	9
4.1 TEST FACILITY.....	9
4.1.1 SUBSTRATE.....	9
4.1.2 SOLAR RADIATION SOURCE.....	10
4.2 CONTROLS.....	11
4.3 TEST INTERRUPTION.....	12
4.3.1 INTERRUPTION DUE TO CHAMBER MALFUNCTION.....	12
4.3.2 INTERRUPTION DUE TO TEST ITEM OPERATION FAILURE.....	13
4.4 TEST EXECUTION.....	13
4.4.1 PREPARATION FOR TEST.....	13
4.4.1.1 PRELIMINARY STEPS.....	13
4.4.1.2 PRETEST STANDARD AMBIENT CHECKOUT.....	13
4.4.2 PROCEDURE I - CYCLING.....	14
4.4.3 PROCEDURE II - STEADY STATE.....	14
5. ANALYSIS OF RESULTS.....	15

MIL-STD-810H
METHOD 505.7

CONTENTS - Continued

<u>Paragraph</u>	<u>Page</u>
6. REFERENCE/RELATED DOCUMENTS	15
6.1 REFERENCED DOCUMENTS.....	15
6.2 RELATED DOCUMENTS.....	15

TABLES

TABLE 505.7-I SPECTRAL POWER DISTRIBUTION.....	7
TABLE 505.7-II TEST PARAMETER TOLERANCES	12

FIGURES

FIGURE 505.7-1 PROCEDURE I - CYCLING TEST	4
FIGURE 505.7-2 PROCEDURE II - STEADY STATE TEST	5

**METHOD 505.7, ANNEX A
DETAILED GUIDANCE ON SOLAR RADIATION TESTING**

1. INTRODUCTION	A-1
2. IRRADIANCE AND SPECTRAL DISTRIBUTION	A-1
2.1 IRRADIANCE	A-1
2.2 SPECTRAL DISTRIBUTION - SEA LEVEL VERSUS HIGH ALTITUDE	A-1
3. OTHER ENVIRONMENTAL FACTORS TO BE CONSIDERED	A-1
4. RADIATION SOURCES	A-1
4.1 GENERAL	A-1
4.2 FILTERS.....	A-2
4.3 UNIFORMITY OF IRRADIANCE.....	A-2
5. MEASUREMENTS.....	A-2
5.1 MEASUREMENT OF SPECTRAL DISTRIBUTION	A-2
5.2 MEASUREMENT OF TEMPERATURE.....	A-2
6. PREPARATION OF TEST FACILITY AND MATERIEL UNDER TEST	A-3
6.1 TEST FACILITY	A-3
6.2 MATERIEL UNDER TEST.....	A-3
6.3 GROUND REFLECTED RADIATION	A-3
7. INTERPRETATION OF RESULTS	A-3
7.1 COMPARISON WITH FIELD EXPERIENCE	A-3
7.2 THERMAL EFFECTS	A-4
7.3 DEGRADATION OF MATERIALS.....	A-4
8. HAZARDS AND PERSONNEL SAFETY.....	A-5
8.1 GENERAL	A-5
8.2 ULTRAVIOLET RADIATION	A-5
8.3 OZONE AND HARMFUL FUMES	A-5
8.4 RISK OF LAMP EXPLOSIONS	A-5
8.5 ELECTRIC SHOCK	A-5

MIL-STD-810H
METHOD 505.7

CONTENTS - Continued

<u>Paragraph</u>		<u>Page</u>
ANNEX A TABLE		
TABLE 505.7A-I	TEST PARAMETER TOLERANCES.....	A-3
METHOD 505.7, ANNEX B INSTRUMENTATION INSTALLATION, PLACEMENT AND GUIDANCE		
INSTRUMENTATION		B-1
ANNEX B TABLE		
TABLE 505.7B-I	INSTRUMENT ACCURACY.....	B-2
METHOD 505.7, ANNEX C GUIDANCE ON TABLES AND FIGURES		
EXAMPLES		C-1
ANNEX C TABLES		
TABLE 505.7C-I	SPECTRAL ENERGY DISTRIBUTION AND PERMITTED TOLERANCE	C-1
TABLE 505.7C-II	EXAMPLE CALCULATION OF SPECTRAL ENERGY DISTRIBUTION AND PERMITTED TOLERANCE	C-6
ANNEX C FIGURES		
FIGURE 505.7C-1	EXAMPLE OF ESTABLISHING TARGET AND UNIFORMITY LEVELS OVER SURFACE TARGET PLANE.....	C-2
FIGURE 505.7C-2	EXAMPLE 1 - FLAT SURFACE EXPOSURE	C-3
FIGURE 505.7C-3	EXAMPLE 2 - TEST ITEM SURFACE SHAPE EXPOSURE.....	C-4
FIGURE 505.7C-4	EXAMPLE 3 - MULTIPLE SOLAR SURFACE TARGET PLANES	C-5
FIGURE 505.7C-5	METHOD FOR CONDUCTING PROCEDURE I WITH SOLAR RADIATION CONTROLLED IN ONE- HOUR STEPS	C-7
FIGURE 505.7C-6	METHOD FOR CONDUCTING PROCEDURE I WITH SOLAR RADIATION CONTROLLED IN HALF- HOUR STEPS	C-8

MIL-STD-810H
METHOD 505.7

(This page is intentionally blank.)

MIL-STD-810H
METHOD 505.7**METHOD 505.7**
SOLAR RADIATION (SUNSHINE)

NOTE: Tailoring is essential. Select methods, procedures, and parameter levels based on the tailoring process described in Part One, paragraph 4.2.2, and Annex C. Apply the general guidelines for laboratory test methods described in Part One, paragraph 5 of this standard.

1. SCOPE.**1.1 Purpose.**

This method has two purposes:

- a. To determine the heating effects of solar radiation on materiel.
- b. To help identify the actinic (photo degradation) effects of exposure to solar radiation.

1.2 Application.

Use this method to evaluate materiel likely to be exposed to solar radiation during its life cycle in the open in hot climates, and when heating or actinic effects are of concern. This Method is valuable in evaluating the effects of direct exposure to sunlight (solar spectrum and energy levels at sea level). Procedure I is useful in determining the temperature increase (over ambient) of materiel caused by solar loading. Although not intended for such, Procedure II may be used to simulate the ultraviolet effect of solar radiation at different locations and altitudes by using various radiation sources that allow reasonable comparison to measurements of these natural solar radiation conditions.

In addition to using Procedure I to evaluate the effects of direct sunlight (actinic effects as well as directional and non-uniform heating for exposed materiel), use Procedure I for determining the heating effects (response temperature) for materiel enclosed within an outer container.

Use Procedure II to evaluate the actinic effects on materiel exposed to long periods of sunshine. The spectrum of the solar array must be measured and conform to the spectrum identified in Table 505.7-I. Deviations from this table may be justified if the test requirements are based on the tailoring process, or if a specific frequency band is of concern. Detail and justify any deviation.

1.3 Limitations.

- a. This test Method does not consider all of the effects related to the natural environment (see Annex A, paragraph 7.2) and, therefore, it is preferable to test materiel at appropriate natural sites.
- b. If the installed environment for an item is within an enclosure, the enclosure must be provided in order to characterize the environment and properly address the heating effects. Once the enclosed environment has been characterized, further testing could be done using Method 501.7.
- c. This Method is not intended to be used for space applications due to the change in irradiance.

2. TAILORING GUIDANCE.**2.1 Selecting this Method.**

After examining requirements documents, review of the LCEP, and applying the tailoring process in Part One of this Standard to determine where solar radiation effects are foreseen in the life cycle of the test item, use the following to confirm the need for this Method and to place it in sequence with other methods.

2.1.1 Effects of Solar Radiation Environments.**2.1.1.1 Heating Effects.**

The heating effects of solar radiation differ from those of high air temperature alone in that solar radiation generates directional heating and thermal gradients. In the solar radiation test, the amount of heat absorbed or reflected depends primarily on the absorptive or reflective surface properties (e.g., roughness, color, etc.) on which the radiation is incident. If a glazing system (glass, clear plastic, or translucent media, e.g., windshield) is part of the test item configuration, and the component of concern is exposed to solar energy that has passed through the glazing system, use a full spectrum source. In addition to the differential expansion between dissimilar materials, changes in the

MIL-STD-810H
METHOD 505.7

intensity of solar radiation may cause components to expand or contract at different rates that can lead to severe stresses and loss of structural integrity. In addition to those identified in Method 501.7, consider the following typical problems to help determine if this Method is appropriate for the materiel being tested. This list is not intended to be all-inclusive.

- a. Jamming or loosening of moving parts.
- b. Weakening of solder joints and glued parts.
- c. Changes in strength and elasticity.
- d. Loss of calibration or malfunction of linkage devices.
- e. Loss of seal integrity.
- f. Changes in electrical or electronic components.
- g. Premature actuation of electrical contacts.
- h. Changes in characteristics of elastomers and polymers.
- i. Blistering, peeling, and de-lamination of paints, composites, and surface laminates applied with adhesives such as radar absorbent material (RAM).
- j. Softening of potting compounds.
- k. Pressure variations.
- l. Sweating of composite materials and explosives.
- m. Difficulty in handling.

2.1.1.2 Actinic Effects.

In addition to the heating effects of paragraph 2.1.1.1, certain degradation from solar energy may be attributable to other portions of the spectrum, particularly the ultraviolet. Since the rate at which these reactions will occur generally increases as the temperature rises, use the full spectrum to adequately simulate the actinic effects of solar radiation. The following are examples of deterioration caused by actinic effects. The list is not intended to be comprehensive.

- a. Fading of fabric and plastic color.
- b. Checking, chalking, and fading of paints.
- c. Deterioration of natural and synthetic elastomers and polymers through photochemical reactions initiated by shorter wavelength radiation. (High strength polymers such as Kevlar are noticeably affected by the visible spectrum. Deterioration and loss of strength can be driven by breakage of high-order bonds (such as pi and sigma bonds existing in carbon chain polymers) by radiation exposure.)

2.1.2 Sequence Among Other Methods.

- a. General. Use the anticipated life cycle sequence of events as a general sequence guide (see Part One, paragraph 5.5).
- b. Unique to this Method. Generally, consider applying the solar radiation test at any stage in the test program. However, high temperatures or actinic effects could affect material's strength or dimensions that could affect the results of subsequent tests such as vibration.

2.2 Selecting Procedures.

This Method includes two test procedures: Procedure I (Cycling for heating effects) and Procedure II (Steady State for actinic effects). Determine the procedure(s) to be used.

2.2.1 Procedure Selection Considerations.

When selecting procedures, consider:

- a. The operational purpose of the test item. Physical degradation that occurs during exposure may produce adverse effects on materiel performance or reliability. Based on the purpose of the materiel, determine functional modes and test data needed to evaluate the performance of the test item during and after exposure to solar radiation.

MIL-STD-810H
METHOD 505.7

- b. The anticipated areas of deployment.
- c. The test item configuration.
- d. The anticipated exposure circumstances (use, transportation, storage, etc.).
- e. The expected duration of exposure to solar radiation.
- f. The expected problem areas within the test item.

Caution: When temperature conditioning, ensure the total test time at the most severe temperature does not exceed the life expectancy of any material (see Part One, paragraph 5.19).

2.2.2 Difference Between Procedures.

While both procedures involve exposing test items to simulated solar radiation, they differ on the basis of timing and level of solar loads. Procedure I is designed to determine the heat produced by solar radiation, and effects of that heat by exposing materiel to continuous 24-hour cycles of simulated solar radiation (or thermal loading) at realistic maximum levels typical throughout the world. Procedure II (Steady State (actinic effects)) is designed to accelerate photo degradation effects produced by solar radiation. This procedure exposes materiel to cycles of intensified solar loads (approximately 2.5 times normal levels) interspersed with dark periods to accelerate actinic effects that would be accumulated over a longer period of time under normal solar loads. Actual acceleration ratios are material dependent, and 2.5 times the natural solar exposure may not provide equal acceleration. This could, however, provide a more rapid test provided the failure mechanisms follow the path expected in the real environment. The key to using either procedure successfully is maintaining enough airflow to prevent the test item from exceeding temperatures that would be attained under natural conditions. Therefore, prior to conducting Procedure II, the maximum response temperature from procedure I or field/fleet data must be known. However, do not use so much airflow that it produces unrealistic cooling.

- a. Procedure I – Cycling (heating and/or minimal actinic effects). Use Procedure I to investigate response temperatures when materiel is exposed in the open in realistically hot climates, and is expected to perform without degradation during and after exposure. Although Procedure I can be performed using simple heat-generating lamps (providing the guidance in paragraph 4.1.2 is followed), limited evaluation of actinic effects is possible if full spectrum lamps are used instead. It is preferable to use the solar radiation test (as opposed to the High Temperature test, Method 501.7) when the materiel could be affected by differential heating (see paragraph 2.1.1.1), or when the levels or mechanisms of heating caused by solar radiation are unknown (this encompasses almost all materiel).
- b. Procedure II – Steady State (actinic effects). Use Procedure II to investigate the effects on materiel of long periods of exposure to sunshine. Actinic effects usually do not occur until materiel surfaces receive large amounts of sunlight (as well as heat and moisture). Therefore, it is inefficient to use the repeated, long cycles of normal levels of solar radiation (as in Procedure I) to generate actinic effects. Using Procedure I for this purpose could take months. The approach, therefore, is to use an accelerated test that is designed to reduce the time to reproduce cumulative effects of long periods of exposure. The 4-hour "lights-off" period of each 24-hour cycle allows for test item conditions (physical and chemical) to return toward "normal" and provide some degree of thermal stress exercising. The key to using Procedure II successfully is maintaining enough cooling air to prevent the test item from exceeding peak response temperatures that would be attained under natural conditions or Procedure I.

MIL-STD-810H
METHOD 505.7

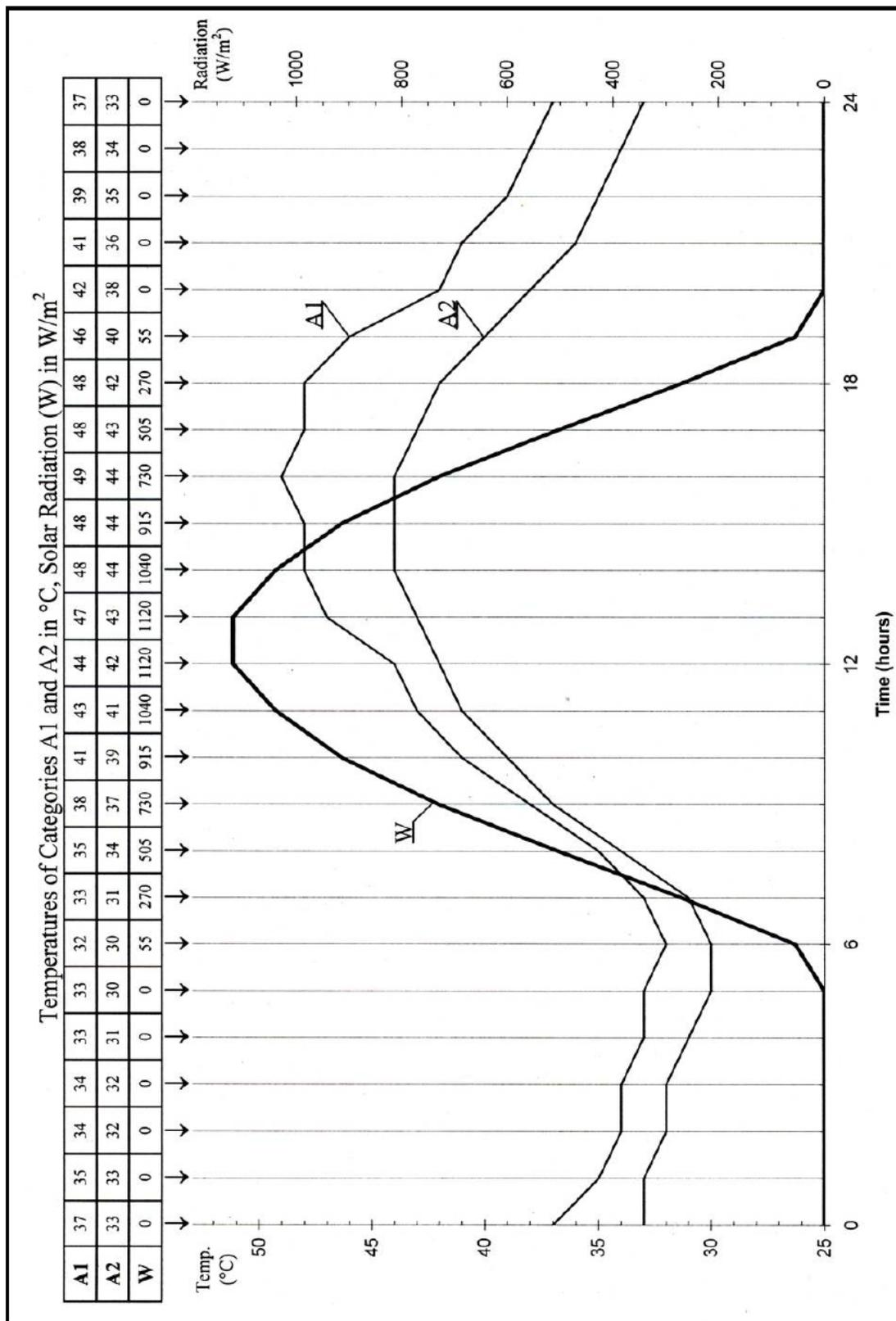


Figure 505.7-1. Procedure I – Cycling test.

MIL-STD-810H
METHOD 505.7

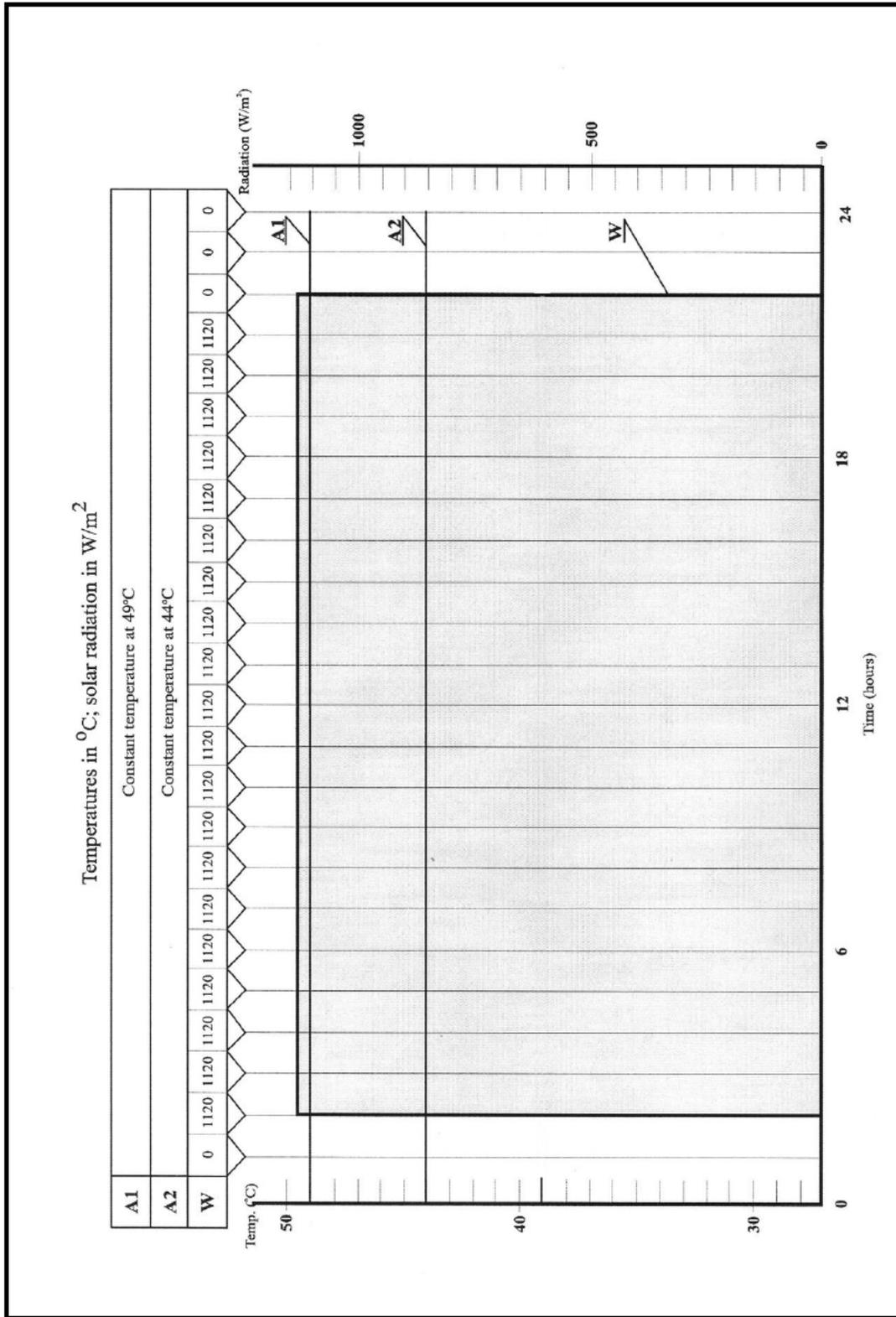


Figure 505.7-2. Procedure II – Steady state test.

MIL-STD-810H
METHOD 505.7

2.3 Determine Test Levels and Conditions.

Having selected this Method and relevant procedures (based on the materiel's requirements documents and the tailoring process), complete the tailoring process by identifying appropriate parameter levels, special test conditions and techniques for these procedures such as the diurnal cycle, test duration, test item configuration, relative humidity, and any additional appropriate conditions. Base these test parameter levels on the Life Cycle Environmental Profile (LCEP – Part One Task 402), requirements documents (see Part One, Figure 1-1), and information provided with this Method. Consider the following in light of the operational purpose and life cycle of the materiel.

2.3.1 Climatic Conditions.

For Procedure I, there are two high temperature diurnal cycles included that correspond to the maximum meteorological conditions in the two climatic categories, A1 and A2 of MIL-HDBK-310 (paragraph 6.1, reference a). Figure 505.7-1 shows the daily cycles of temperature and solar radiation corresponding to categories A1 and A2 for Procedure I. Choose the conditions for the test according to the planned climatic categories for use of the materiel:

- a. Worldwide deployment. Cycle A1 has peak conditions of 1120 W/m² (355 BTU/ft²/hr) and 49 °C (120 °F) (but not occurring at the same time of day), and is normally accompanied by some degree of naturally occurring winds. It represents the hottest conditions exceeded not more than one percent of the hours in the most extreme month at the most severe locations that experience very high temperatures accompanied by high levels of solar radiation, namely, hot, dry deserts of north Africa, southwest and south central Asia, central and western Australia, northwestern Mexico, and the southwestern USA.
- b. Cycle A2 has peak conditions of 1120 W/m² and 43 °C (110 °F) (but not occurring at the same time of day) and represents less severe conditions at locations that experience high temperatures accompanied by high levels of solar radiation, winds, and moderately low humidity, namely, the most southerly parts of Europe, most of the Australian continent, south central Asia, northern and eastern Africa, coastal regions of north Africa, southern parts of the US, and most of Mexico. Use this cycle when the materiel is to be used only in geographical locations described in category A2, but not in category A1.
- c. Figure 505.7-2 shows the corresponding temperature and solar radiation levels for Procedure II.

2.3.2 Test Duration.

- a. Procedure I. Expose the test item to continuous 24-hour cycles of controlled simulated solar radiation and temperature as indicated on Figure 505.7-1 or as identified in the requirements documents. A goal of this test is to establish the highest temperature that the test item will reach during repeated cycles. Perform at least three continuous cycles. If the maximum of the peak response temperature of the previous 24-hour cycle) is not reached (± 2 °C (± 3.6 °F)) during three cycles, continue the cycles until repeated peak temperatures are reached, or for seven cycles, whichever comes first. In the absence of other guidance, the maximum test duration of seven cycles was chosen because the peak high temperature for the selected climatic region occurs approximately one hour in each of seven cycles in the most extreme month. If more exact simulation is required, consult meteorological data for the particular areas under consideration. This may include adjustment of solar energy, if appropriate, to account for latitude, altitude, month of anticipated exposure, or other factors (for example, a product exclusively used in northern areas, or exclusively used in winter months). Any deviation from the standard conditions must be detailed and justified in the test report.
- b. Procedure II. Procedure II produces an acceleration factor of approximately 2.5 as far as the total energy received by the test item is concerned, i.e., one 24-hour cycle as shown on Figure 505.7-2 provides approximately 2.5 times the solar energy experienced in one 24-hour (natural) diurnal cycle plus a 4-hour lights-off period to allow for alternating thermal stressing and for the so-called "dark" processes to occur. To simulate 10 days of natural exposure, for instance, perform four 24-hour cycles as shown on Figure 505.7-2. Recommend ten 24-hour cycles (as on Figure 505.7-2) for materiel that is occasionally used outdoors, such as portable test items, etc. For materiel continuously exposed to outdoor conditions, recommend 56 or more 24-hour cycles. Do not increase the irradiance above the identified level. Presently there is no indication that attempting to accelerate the test in this way gives results that correlate with materiel response under natural solar radiation conditions.

2.3.3 Humidity.

Various levels of relative humidity occur naturally, and humidity combined with temperature and solar radiation can, in many cases, have deleterious effects on materiel. If the materiel is known or suspected to be sensitive to RH,

MIL-STD-810H
METHOD 505.7

include it in the Procedure I test requirements. MIL-HDBK-310 and NATO STANAG 4370, AECTP 230, (paragraph 6.1, references a and b) have temperature-humidity data for various regions of the Earth.

2.3.4 Configuration.

- a. Use the same test item configuration as during exposure to natural solar radiation. The orientation of the test item relative to the direction of radiation will have a significant impact on the heating effects. In cases where several test item components are already known to be sensitive to solar effects, consider adjusting the relative test item/solar radiation source orientation to simulate a natural diurnal cycle. Whenever possible, mount the test item so that its configuration is representative of actual deployment, as provided in the requirements document. This mounting may include supports or a substrate of specified properties (e.g., a layer of concrete of specified thickness or a sand bed of certain reflectivity). (See paragraph 4.1.1.)
- b. Surface contamination. Dust and other surface contamination may significantly change the absorption characteristics of irradiated surfaces. Unless otherwise required, ensure the test items are clean when tested. However, if the effects of surface contamination are to be assessed, include in the relevant requirements document the necessary information on preparation of surfaces.

2.3.5 Spectral Power Distribution - Sea Level versus High Ground Elevations.

At high ground elevations solar radiation contains a greater proportion of damaging UV radiation than at sea level. Although the internationally agreed spectrum shown in Table 505.7-I is recommended for general testing, it is a closer representation of the real environment at sea level. This standard spectrum may be used (unless other data are available) for both sea level and high ground elevations.

Table 505.7-I. Spectral power distribution.

Spectral Region	Bandwidth (nm)	Natural Radiation (% of total)	Tolerance (% of total)		Irradiance (W/m ²)	Spectral Region Irradiance (W/m ²)
			Min	Max		
Ultraviolet - B	280-320	0.5	0.3	0.7	5.6	5.6
Ultraviolet - A	320-360	2.4	1.8	3	26.9	62.7
	360-400	3.2	2.4	4.4	35.8	
Visible	400-520	17.9	16.1	19.7	200.5	580.2
	520-640	16.6	14.9	18.3	185.9	
	640-800	17.3	12.8	19	193.8	
Infrared	800-3000	42.1	33.7	50.5	471.5	471.5
Totals					1120	1120

NOTE: The amount of radiation wavelength shorter than 300 nm reaching the Earth's surface is small but the effect on the degradation of material can be significant. Short wavelength energy below 300 nm can cause materials to fail unnecessarily (if not present in the natural exposure). In reverse, if energy below 300 nm is present in the natural environment and not present in the accelerated exposure, material that should fail may pass the test. This is entirely material dependent because it relates to the end use in natural exposure. Values in the above table have been taken from DIN 75220. (See Annex A, paragraph 2.2.)

2.3.6 Temperature.

In addition to the temperature guidance given elsewhere in this Method, it is essential to maintain the air temperature in the vicinity of the test item to that in the respective profile (A1 or A2) or as specified in the test plan. To do so requires necessary airflow and air temperature measurement (sensors shielded from radiation) in the immediate vicinity of the test item. See Annex A, paragraph 5.2 for temperature measurement guidance.

2.3.7 Airflow.

The key to using this Method successfully is maintaining enough airflow to obtain the test item peak response temperatures that would be attained under natural conditions.

For Procedure I, use an airspeed of 1.5 to 3.0 m/sec (300 to 600 ft/min) unless otherwise specified. If the deployed environment will subject the item to either limited or no wind speed (shielded from natural wind), then use a minimum air speed, no less than 0.25 m/sec (50 ft/min), when conducting Procedure I. Generally, an airflow of as little as 1 m/s

MIL-STD-810H
METHOD 505.7

(200 ft/min) can cause a reduction in temperature rise of over 20 percent as compared to still air. To ensure test repeatability, the air speed must be measured and recorded in the test report.

For Procedure II, use the minimum required airspeed required to maintain the thermal response as measured in the natural environment or Procedure I. This implies that before this test can be performed, the maximum temperature response the materiel would experience under natural conditions (by using field/fleet data or as determined by running Procedure I) must be known. However, do not use so much cooling air that it produces unrealistic cooling. Similarly, if multiple and identical test items are to be tested, use one or more of the items for the preliminary test to determine the maximum temperature response. Since actinic effects are highly dependent upon the solar radiation spectrum (as well as intensity and duration), the spectrum must be as close as possible to that of natural sunlight (see Table 505.7-I).

2.4 Test Item Operation.

When it is necessary to operate the test item, use the following guidelines for establishing test operating procedures.

WARNING: If the sheltered environment is intended to be occupied by personnel during exposure to high temperature, it is recommended that sensors are installed to detect VOCs, CO, and Phthalates due to potential out-gassing.

- a. General. See Part One, paragraph 5.8.2.
- b. Unique to this Method.
 - (1) Include operating modes that consume the most power (generate the most heat).
 - (2) Include the required range of input voltage conditions, if changes in voltage could affect the test item thermal dissipation or response (e.g., power generation or fan speed).
 - (3) Introduce any cooling media that normally would be applied during service use (e.g., forced air or liquid coolant). Consider using cooling medium inlet temperatures and flow rates that represent both typical and worst-case degraded temperature and flow conditions.

3. INFORMATION REQUIRED.

3.1 Pretest.

The following information is required to conduct solar radiation tests adequately.

- a. General. Information listed in Part One, paragraphs 5.7 and 5.9, and Annex A, Task 405 of this Standard.
- b. Specific to this Method.
 - (1) Appropriate diurnal cycle (for Procedure I) to include humidity if appropriate.
 - (2) Test item operational requirements.
 - (3) Spectral power distribution of the source lighting (e.g., to reproduce conditions of a previous test).
 - (4) Any additional guidelines.
 - (5) Temperature/radiation measurement techniques and locations.
 - (6) Substrate or method of test item mounting.
 - (7) Wind speed.
 - (8) Identify sensor location(s) for determination of peak response temperature stabilization.
 - (9) Location and mounting configuration for the pyranometer (see Annex B, paragraph 1.3)
- c. Tailoring. Necessary variations in the basic test procedures to accommodate environments identified in the LCEP.

3.2 During Test.

Collect the following information during conduct of the test:

- a. General. Information listed in Part One, paragraph 5.10, and in Annex A, Tasks 405 and 406 of this Standard.

MIL-STD-810H
METHOD 505.7

b. Specific to this Method.

- (1) Record of chamber temperatures (and humidity if required) and light intensity versus time conditions.
- (2) Record of the test item temperature-versus-time data for the duration of the test.
- (3) Record of test wind speed.

3.3 Post-Test.

The following post-test data shall be included in the test report.

- a. General. Information listed in Part One, paragraph 5.13, and in Annex A, Task 406 of this Standard.
- b. Specific to this Method.
 - (1) Location of temperature sensors on the test item.
 - (2) Test item response temperatures (and humidity if required), and number of diurnal cycles or exposure periods.
 - (3) Record of test wind speed.
 - (4) Spectral power distribution of the source lighting (e.g., to reproduce conditions of a previous test).
 - (5) Solar lamp bank identification.
 - (6) Any additional data required.
 - (7) Any deviations from the original test plan – to include wind speed (if necessary to adjust it).
 - (8) Any deviation from the required spectral power distribution as stated in Table 505.7-I, and justification.
 - (9) Location and mounting configuration for the pyranometer

4. TEST PROCESS.

4.1 Test Facility.

- a. The facility requirements consist of a chamber or cabinet, auxiliary instrumentation, and a solar lamp bank. This apparatus must be capable of maintaining and monitoring (see Part One, paragraph 5.18) the required conditions of temperature, airflow, and irradiation.
- b. Full spectrum lamps are recommended for both procedures, however Procedure I can be performed using lamps that do not meet the spectral energy distribution of Table 505.7-I, provided the guidance in paragraph 4.1.2 is followed.
- c. For both procedures consider the possible cooling effects of airflow over the test specimens. Caution is advised on the use of the low airspeed; rarely do high solar and high temperature events occur in nature without accompanying winds.
 - (1) Procedure I: Unless otherwise justified, use an airspeed between 1.5 to 3.0 m/sec (300 to 600 ft/min). See paragraph 2.3.7 for additional details.
 - (2) Procedure II: Unless otherwise justified, use an airflow rate sufficient enough to maintain the test item response temperature that was either determined from Procedure I or obtained from field data.
- d. To minimize or eliminate re-radiation from chamber surfaces, experience has shown that the best method is when the volume of the test chamber is a minimum of 10 times that of the envelope volume of the test item. (Consider the beam angles of the light source hitting the walls of the test chamber.)
- e. It is recommended that the solar radiation source area be such that the length and width of the target area of the test item are no more than one-half the dimensions of the lamp bank.

4.1.1 Substrate.

Mount the test item either on raised supports or on a substrate of specified properties, e.g., a layer of concrete of specified thickness or a sand bed of a thermal conductivity and reflectivity representative of actual deployment, as provided in the requirements documents.

MIL-STD-810H
METHOD 505.7**4.1.2 Solar Radiation Source.**

- a. Full spectrum lamps are recommended for both procedures.
- b. Use a maximum irradiance intensity of 1120 W/m^2 (± 4 percent or 15 W/m^2 , whichever is greater) and ensure the radiation across the upper surface of the test item area of concern is uniform to within 10 percent of the desired value.
- c. The diurnal variation in solar energy may be applied continuously (see Figure 505.7-I) or incrementally (see Figures 505.7C-5 and -6), with a minimum of eight levels, provided that the total energy of the cycle is maintained.
- d. Where only thermal effects, Procedure I, are being assessed, it is essential to maintain at least the visible and infrared portions of the spectrum as in Table 505.7-I. However, if not feasible, deviate from the spectral distribution as necessary, but adjust the irradiance to give an equivalent heating effect. Document any deviation from the solar power distribution (Table 505.7-I), and record it in the test report. If using infrared lamps, exercise caution because infrared-reflecting/absorbing coatings will reflect or absorb energy based on spectrum and an infrared light system may not produce realistic thermal effects when various material colors and structures are under evaluation. If a glazing system is incorporated in the materiel (see paragraph 2.1.1.1), verify that the infrared transmission is not affected when using an infrared source. Use a full spectrum source if attenuating coatings, glazing, or other systems that may affect spectral reflection/absorption are used in/on the test item. In order to determine the amount of adjustment necessary, employ either of two methods below, and document it in the test report:
 - (1) Mathematically calculate the adjustment using the spectral reflectance or transmittance of the irradiated surfaces, and the spectral energy distribution of the particular lamps being used (and also the effect of any associated reflectors or glasses).
 - (2) Empirically determine the adjustment by conducting a pre-test on samples that are representative of the materiel (the most important characteristics are material composition, color, and surface roughness). Measure the temperature rise above ambient air temperature of test samples under natural solar radiation conditions (the climatic category identified in the LCEP as the most extreme), and compare the results with the temperature rise above ambient (chamber) air temperature of test samples under simulated solar radiation. Gather an adequate amount of data under the natural condition portion of the test to account for the cooling effects of airflow over the samples (i.e., outdoor conditions rarely provide zero wind), and extrapolate the temperature rise at zero wind conditions to be comparable to results from chamber samples. This process requires the use of extensive multi-year stable data sets to establish a statistically viable analysis.
- e. Where actinic effects are to be assessed, (Procedure II), ensure the spectral distribution of the light source adheres to the distribution given in Table 505.7-I (within the given tolerances).
- f. Direct the radiation onto the test item and irradiate the entire surface of the test item facing the solar radiation source. To provide the highest degree of confidence in the measurements, the value of 1120 W/m^2 theoretically includes all radiation received by the test item, including any radiation reflected from the chamber walls and any long-wave infrared radiation (but not greater than $3 \mu\text{m}$) emitted by the chamber walls. Radiation reflected or emitted from the chamber walls is generally substantially lower than the radiation emitted directly from the light source, and a measurement device that has a measurement range of 285-2800 nm should be sufficient to measure direct and reflected radiation. Additionally, if the intent of the test is to determine thermal heat loading (see paragraph 4.1.2h(2)), use a radiation measuring device that has the capability to measure infrared energy, and calibrate the radiation measuring device in the full wavelength range it is designed to measure.
- g. To prevent localized effects such as unintentional heating from individual bulbs, locate the radiation source at least 76 cm (30 inches) away from any surface of the test item. Spot lamps (as opposed to flood lamps) may produce a non-uniform exposure.
- h. Light source. The following lists are not intended to exclude new lamps made available by advanced technology. It may be necessary to use filters to make the spectrum comply with that specified in Table 505.7-I. Further guidance is given in Annex A.

MIL-STD-810H
METHOD 505.7

- (1) Tests conducted for degradation and deterioration of materials due to actinic effects as well as heat buildup within the test items must satisfy the full spectrum of Table 505.7-I and may use one of the following acceptable radiation sources:
- (a) Metal halide lamps (designed for full spectrum application).
 - (b) Xenon arc or mercury xenon arc (used singularly) with suitable reflector.
 - (c) Combination of high pressure sodium vapor and improved mercury vapor with suitable reflectors.
 - (d) High-intensity multi-vapor, mercury vapor (with suitable reflectors), and incandescent spot lamps.

NOTE: Use other combinations of the lamps listed above and below if it is proven that the combination produces the spectrum of Table 505.7-I.

- (2) Use the appropriate lamps from the following list for tests conducted to assess heating effects alone (and not actinic effects).
- (a) Mercury vapor lamps (internal reflector type only).
 - (b) Combination of incandescent spot and tubular-type mercury vapor lamps w/ external reflectors.
 - (c) Combination of incandescent spot lamps and mercury vapor lamps with internal reflectors.
 - (d) Metal halide.
 - (e) Xenon arc or mercury xenon arc lamps with suitable reflectors.
 - (f) Multi-vapor (clear or coated bulb) with suitable reflectors.
 - (g) Tungsten filament lamps.
 - (h) Any other heat producing lamp.

4.2 Controls.

- a. Temperature. Maintain the chamber air temperature (as specified in the test plan) in accordance with Part One, paragraph 5.2a. In order to adequately measure the temperature of the air surrounding the test item, measure it (with adequate shielding from radiated heat - see Annex A, paragraph 5.2) at a point or points in a horizontal reference plane at the approximate elevation of the upper surface of the test item, and as close as possible to the test item, making adequate provision for shielding from the effects of radiant heat from the test item. This is one way to ensure reasonable control of the envelope of air surrounding the test item. The temperature sensors used to measure the thermal response of the test item will also be affected by direct radiation of the light source. When practical, mount these sensors to the inside surface of the external case (upper surface) of the test item.
- b. Test Sensors and Measurements. Use a pyranometer, pyrhelimeter or other suitable device to measure the total radiated energy imposed on the test item. Use a pyranometer with suitable filters or a spectroradiometer to measure the spectral distribution of the radiation imposed on the test item. A filtered pyranometer can only provide an approximate measurement of the spectral distribution. However, a spectroradiometer, although more delicate to employ, can provide a precise measurement of the spectral distribution. Use other measuring instruments only if they can satisfy the required specifications. See Annex B for the required measurement accuracy of these commonly used instruments. Test parameter tolerances appear in Table 505.7-II.

MIL-STD-810H
METHOD 505.7**Table 505.7-II. Test parameter tolerances.**

Test Parameter	Description	Tolerance
Total Spectral Irradiance	Sum of energy for all spectral bandwidths at a target irradiance level on the test profile (diurnal curve or constant irradiance).	± 4 percent or ± 15 W/m ² (whichever is greater) of the target irradiance.
Spectral energy Distribution	Energy within each spectral bandwidth at a single measurement point.	See Table 505.7-I tolerance for each bandwidth.
Irradiance Uniformity	Deviation between the measured and target irradiance at all measurement points on the target plane. The number of points shall be adequate to define irradiance variation across the target plane(s) to meet the specific test requirement.	± 10 percent deviation from the target irradiance
Instrumentation	Pyranometer, pyrheliometer, or radiometer	See Annex B
Temperature	Chamber control	± 2 °C (± 3.6 °F)
Air Speed	Across the test item	1.5 to 3.0 m/sec (300 to 600 ft/min)

Note: When performing Procedure I, it is not required to provide a total irradiance energy level below a minimum level of 55 W/m² (280-3000 nm). If the diurnal curve calculated energy value is below 55 W/m² (280-3000 nm), a target value of 55 W/m² (280-3000 nm) may be used for the specified time period.

- c. Calibration of chamber. Because of the variety of permissible lamps and chamber designs, it is particularly important that the chamber be calibrated to assure the proper levels of radiant infrared energy are impacting the test area when heat alone is of concern, and that the proper intensity and spectral distribution of solar radiation are impacting the test area when actinic effects are of concern. See Table 505.7-I for spectral distribution and permitted tolerances.

If the test item is not available at the time the chamber is being calibrated, ensure the radiation uniformity is within 10 percent of the desired value when measured over the area covered by the test item, at a horizontal reference plane at the approximate elevation of the upper surface position of the test item. If the test item is available at the time the chamber is being calibrated, ensure the radiation uniformity is within 10 percent of the desired value when measured over the upper surface of the test item. As most types of lamps age, their spectral outputs change. To ensure that solar radiation chambers meet established specifications, perform a thorough check on spectral distribution, intensity, and uniformity at intervals not exceeding 500 hours of operation. Conduct a check of the overall intensity and uniformity before and after every test.

- d. Record chamber temperature, solar radiation intensity, spectral distribution, wind speed, and humidity (if required) at a sufficient rate to capture data necessary for post-test analysis (see Part One, paragraph 5.18).

4.3 Test Interruption.

Test interruptions can result from two or more situations, one being from failure or malfunction of test chambers or associated test laboratory equipment. The second type of test interruption results from failure or malfunction of the test item itself during required or optional performance checks.

4.3.1 Interruption Due to Chamber Malfunction.

- a. General. See Part One, paragraph 5.11, of this Standard.
- b. Specific to this Method.
- (1) Undertest interruption.
 - (a) Procedures I and II. The test rationale is based on the total cumulative effect of the solar environment. Except as noted in (b) below, follow any undertest interruption by re-stabilization at the identified levels and continuation of the test from the point of the interruption.
 - (b) Procedure I. The test is considered complete if an interruption occurs after 19 hours of the last cycle of Procedure I. (At least 92 percent of the test would have been completed, and the probability of a failure is low during the remaining reduced levels of temperature and solar radiation.)

MIL-STD-810H
METHOD 505.7

- (2) Overtest interruption. Follow any overtest conditions by a thorough examination and checkout of the test item to verify the effect of the overtest. Since any failure following continuation of testing will be difficult to defend as unrelated to the overtest, use a new test item and restart the test at the beginning.

4.3.2 Interruption Due to Test Item Operation Failure.

Failure of the test item(s) to function as required during mandatory or optional performance checks during testing presents a situation with several possible options.

- a. The preferable option is to replace the test item with a “new” one and restart from Step 1.
- b. A second option is to replace / repair the failed or non-functioning component or assembly with one that functions as intended, and restart the entire test from Step 1.

NOTE: When evaluating failure interruptions, consider prior testing on the same test item and consequences of such.

4.4 Test Execution.

The following steps, alone or in combination, provide the basis for collecting necessary information concerning the test item in a solar radiation environment.

4.4.1 Preparation for Test.

4.4.1.1 Preliminary Steps.

Before starting the test, review pretest information in the test plan to determine test details (e.g., procedures, item configuration, cycles, durations, parameter levels for storage/operation, etc.). (See paragraph 3.1 above.)

- a. The required test procedures.
- b. The diurnal cycle to be used.
- c. Other variables, such as number of cycles, etc.
- d. Degree of removal of surface contamination necessary (see paragraph 4.2b). If the effects of surface contamination are to be assessed, include in the relevant requirements document the necessary information on preparation of surfaces.
- e. Comparative information. For eventual comparison between pre- and post-test items, photograph the test item and take material samples (if required).

4.4.1.2 Pretest Standard Ambient Checkout.

All items require a pretest standard ambient checkout to provide baseline data. Conduct the checkout as follows:

- Step 1. In order to determine thermal response (paragraph 3.3b(2)), install temperature sensors in, on, or around the test item as described in the test plan.
- Step 2. Install the test item in the chamber (Part One, paragraph 5.8) and stabilize it at standard ambient conditions (Part One, paragraph 5.1) and in a manner that will simulate service use, unless the storage configuration is specified (see paragraph 2.3.4). Position the test item in accordance with the following:
 - a. As near the center of the test chamber as practical and so that the surface of the item is not closer than 30 cm (12 in.) to any wall or 76 cm (30 in.) to the radiation source when the source is adjusted to the closest position it will assume during the test
 - b. Oriented, within realistic limits, to expose its most vulnerable parts to the solar radiation, unless a prescribed orientation sequence is to be followed.
 - c. Separated from other items that are being tested simultaneously, to ensure that there is no mutual shading or blocking of airflow unless this, also, is representative of the materiel's field use.

MIL-STD-810H
METHOD 505.7

- Step 3. Conduct a visual examination of the test item with special attention to stress areas, such as corners of molded cases, and document the findings.
- Step 4. Conduct an operational checkout in accordance with the test plan and record the results.
- Step 5. If the test item operates satisfactorily, place it in its test configuration (if other than operational) and proceed to the first test as identified in the test plan. If not, resolve the problem and restart the checkout procedure.

4.4.2 Procedure I - Cycling.

- Step 1. Adjust the chamber temperature and stabilize the test item to the conditions shown in the appropriate climatic category (zone A1 or A2) for time 0000.
- Step 2. Expose the test item to continuous 24-hour cycles of controlled simulated solar radiation and dry-bulb temperature as indicated on Figure 505.7-1 or as identified in the requirements document, measuring and recording test item temperatures throughout the exposure period. If the test facility is unable to perform the continuous curve of Figure 505.7-1, increase and decrease the solar radiation intensity in a minimum of eight levels (see Annex C, Figures 505.7C-5 and C-6 for the stepped levels) for each side of the cycle, provided the total energy of the cycle as well as the spectral power distribution is maintained. Perform at least three continuous cycles. If the maximum of the peak response temperature of the previous 24-hour cycle is not reached (± 2 °C (± 3.6 °F)) during three cycles, continue the cycles until repeated peak temperatures are reached, or for seven cycles, whichever comes first.
- Step 3. Based on the requirements document, the test item may or may not be operated continuously throughout the test. If operation is required, operate the test item when the peak response temperature occurs. For some single-use items (e.g., rockets), use thermocouples affixed to critical portions of the test item to determine the time and value of peak temperature. Conduct the operational checkout of the test item as in paragraph 4.4.1.2, Step 5. Document the results as well as the peak temperature. If the test item fails to operate as intended, follow the guidance in paragraph 4.3.2 for test item failure.
- Step 4. Adjust the chamber air temperature to standard ambient conditions and maintain until temperature stabilization of the test item has been achieved.
- Step 5. Conduct a complete visual examination of the test item and document the results. For comparison between pre- and post test items, photograph the test item and take material samples (if required).
- Step 6. Conduct an operational checkout of the test item as in paragraph 4.4.1.2, Step 5. See paragraph 5 for analysis of results.
- Step 7. Compare these data with the pretest data.

4.4.3 Procedure II - Steady State.

NOTE: If Procedure I has not been previously performed and no field/fleet data are available, conduct a preliminary test carried out in accordance with Procedure I (absolute minimum of three complete cycles) to determine the approximate maximum response temperature of the test item.

- Step 1. Adjust the chamber air temperature to the max temperature shown in the appropriate climatic zone (zone A1 or A2) as indicated on Figure 505.7-2 or the temperature identified in the test plan.
- Step 2. Adjust the solar radiation source to a radiant energy rate of 1120 ± 47 W/m² or as identified in the test plan. Use sufficient air speed to maintain the test item temperature to the peak response temperature obtained in procedure I or obtained from field data.
- Step 3. Maintain these conditions for 20 hours, measuring and recording the test item temperatures. If required, conduct operational checks during the last four hours of each 20-hour exposure when test temperatures are maximized. If the test item fails to operate as intended, follow the guidance in paragraph 4.3.2 for test item failure.
- Step 4. Turn off the solar radiation source for four hours.
- Step 5. Repeat Steps 1 through 4 for the number of cycles identified in the test plan.

MIL-STD-810H
METHOD 505.7

- Step 6. At the end of the last radiation cycle, allow the test item to return to standard ambient conditions.
- Step 7. Conduct a visual examination and an operational check as in Steps 3 and 5 of paragraph 4.4.1.2, and document the results. Take photographs of the test item and material samples (if required) for comparison between pre- and post-test items. See paragraph 5 for analysis of results.

5. ANALYSIS OF RESULTS.

In addition to the guidance provided in Part One, paragraphs 5.14 and 5.17, the following information is provided to assist in the evaluation of the test results. Analyze any failure of a test item to meet the requirements of the materiel specifications.

- a. Procedure I. Do not alter the performance characteristics either at the peak temperature or after return to standard ambient conditions to the extent that the test item does not meet its requirements. Record as observations only those actinic effects that do not affect performance, durability, or required characteristics.
- b. Procedure II. Do not alter the performance and characteristics (such as color or other surface conditions) of the test item to the extent that the test item does not meet requirements. Record actinic effects that do not affect performance, durability, or required characteristics as observations only. The fading of colors could result in higher heating levels within the test item.

6. REFERENCE/RELATED DOCUMENTS.

6.1 Referenced Documents.

- a. MIL-HDBK-310, Global Climatic Data for Developing Military Products.
- b. NATO STANAG 4370, Allied Environmental Conditions and Test Publication (AECTP) 230; Climatic Conditions.
- c. "Ultraviolet Radiation," L.R. Koller; Wiley, 2nd Edition, 1965.
- d. ISO 9060, "Solar Energy – Specification and Classification of Instruments for Measuring Hemispherical Solar and Direct Solar Radiation," 1990-11-01.
- e. ISO-9847 "Solar Energy – Calibration of Field Pyranometers by Comparison to a Reference Pyranometer," 1992.
- f. ASTM E824-05, Standard Test Method for Transfer of Calibration from Reference to Field Radiometers, 2005
- g. The Photonics Dictionary, 2002 48th edition; Laurin Publishing.

6.2 Related Documents.

- a. AR 70-38, Research, Development, Test and Evaluation of Materiel for Extreme Climatic Conditions.
- b. Synopsis of Background Material for MIL-STD-210B, Climatic Extremes for Military Equipment. Bedford, MA: AF Cambridge Research Laboratories, January 1974. DTIC number AD-780-508.
- c. Egbert, Herbert W. "The History and Rationale of MIL-STD-810 (Edition 2)," January 2010; Institute of Environmental Sciences and Technology, Arlington Place One, 2340 S. Arlington Heights Road, Suite 100, Arlington Heights, IL 60005-4516.
- d. NATO STANAG 4370, Allied Environmental Conditions and Test Publication (AECTP) 300, Climatic Test Methods, Method 305, Solar Radiation.
- e. "Ultraviolet Spectral Energy Distribution of Natural Sunlight and Accelerated Test Light Sources," R.C. Hirt, R.G. Schmitt, N.D. Searle and A.P. Sullivan; Journal of the Optical Society of America, July 1960, vol. 50, p. 706.
- f. "Studies of Spectral Energy Distribution of Different Light Sources in Connection with Solar Simulation," D.W. Gibson and J. Weinard; Institute of Environmental Sciences 1962 Proceedings, p. 453. Institute of Environmental Sciences and Technology, Arlington Place One, 2340 S. Arlington Heights Road, Suite 100, Arlington Heights, IL 60005-4516.
- g. "An Artificial Sunshine Solarium," G.F. Prideaux, Illuminating Engineering, 1946, Vol. 12, p.762.

MIL-STD-810H
METHOD 505.7

- h. "Project Assess - a Report of a Long Term Solar Simulation Test," R. Kruger, Institute of Environmental Sciences 1966 Proceedings, p. 271. Institute of Environmental Sciences and Technology, Arlington Place One, 2340 S. Arlington Heights Road, Suite 100, Arlington Heights, IL 60005-4516.
- i. "Spectral Distribution of Typical Daylight as a Function of Correlated Color Temperature," D.B. Judd, D.L. MacAdam and G. Wyszecki; Journal of the Optical Society of America, August 1964, vol. 54, p. 1031.
- j. "Simulating the Solar Spectrum with a Filtered High-pressure Xenon Lamp," E.A. Boettner and L.J. Miedler, Applied Optics, 1963, vol. 2, p. 105.
- k. "Modular Xenon Solar Simulation of Large Area Application," J.A. Castle, Institute of Environmental Sciences, 1967 Proceedings, p. 687. Institute of Environmental Sciences and Technology, Arlington Place One, 2340 S. Arlington Heights Road, Suite 100, Arlington Heights, IL 60005-4516.
- l. "Four-foot Solar Simulation System," R.N. Harmon, Institute of Environmental Sciences 1966 Proceedings p. 531. Institute of Environmental Sciences and Technology, Arlington Place One, 2340 S. Arlington Heights Road, Suite 100, Arlington Heights, IL 60005-4516.
- m. "Radiation Instruments and Measurements," International Geophysical Year Manual, Part VI, 1958, Pergamon Press.
- n. "Deterioration of Materials," G.A. Greathouse and C.J. Wassel, Reinhold, New York, 1954.
- o. "The Simulation of Solar Radiant Energy," P.W. Baker, Environmental Engineering Quarterly June 1963, p. 17-19 and Sept 1963, p. 14-17.
- p. "Measurement of Spectral Irradiance," J. Arveson, Handbook of Solar Simulation for Thermal Vacuum Testing, Section 9B Institute of Environmental Sciences, 1968. Institute of Environmental Sciences and Technology, Arlington Place One, 2340 S. Arlington Heights Road, Suite 100, Arlington Heights, IL 60005-4516.
- q. "The Solar Constant and the Solar Spectrum Measured from a Research Aircraft," M.P. Thekaekara, NASA TR R-351, Washington, DC, Oct 1970.

(Copies of Department of Defense Specifications, Standards, and Handbooks, and International Standardization Agreements are available online at <https://assist.dla.mil>.)

ASTM documents are available from the ASTM International Website.

Requests for other defense-related technical publications may be directed to the Defense Technical Information Center (DTIC), ATTN: DTIC-BR, Suite 0944, 8725 John J. Kingman Road, Fort Belvoir VA 22060-6218, 1-800-225-3842 (Assistance--selection 3, option 2), <http://www.dtic.mil> and the National Technical Information Service (NTIS), Springfield VA 22161, 1-800-553-NTIS (6847), <http://www.ntis.gov/>.

MIL-STD-810H
METHOD 505.7, ANNEX A**METHOD 505.7, ANNEX A****DETAILED GUIDANCE ON SOLAR RADIATION TESTING****1. INTRODUCTION.**

This Annex describes methods of simulation designed to examine the effects of solar radiation on materiel. The main quantities to be simulated are the spectral energy distribution of the sun as observed at the Earth's surface and the intensity of received energy, in combination with controlled temperature conditions. However, it may be necessary to consider a combination of solar radiation - including sky radiation - with other environments, e.g., humidity, air velocity, etc.

2. IRRADIANCE AND SPECTRAL DISTRIBUTION.

The effect of radiation on the materiel will depend mainly on the level of irradiance and its spectral distribution.

2.1 Irradiance.

The irradiance by the sun on a plane perpendicular to the incident radiation outside the Earth's atmosphere at the mean Earth-Sun distance is known as the solar constant "I₀." The irradiance at the surface of the Earth is the result of the solar constant and the influence of attenuation and scattering of radiation in the atmosphere. For test purposes, a maximum intensity of 1120 W/m² is specified to simulate the global (total) radiation at the surface of the Earth from the Sun and the sky with the Sun at zenith, based on a solar constant I₀ = 1350 W/m². The true solar constant is thought to be about 1365-1370 W/m².

2.2 Spectral Distribution - Sea Level versus High Altitude.

At high altitude, solar radiation contains a greater proportion of damaging UV radiation than at sea level. The internationally-agreed spectrum (see Table 505.7-I) recommended for general testing is a representation of the real environment at sea level. This spectrum is recommended for use at both sea level and at high altitude.

3. OTHER ENVIRONMENTAL FACTORS TO BE CONSIDERED.

Attention is drawn to the possible cooling effects of air flow over materiel. In practice, high solar radiation conditions are rarely accompanied by complete absence of wind. It may be necessary, therefore, to assess the effect of different air velocities over materiel under test. The materiel specification should state any special requirements in this respect. It is essential, therefore, to measure and control the rate of air flow in order to maintain the required air temperature at the test item. Excessive or un-controlled air flow can also result in misleading errors in open-type thermopiles used to monitor radiation intensity; ventilation of pyranometers may be necessary to keep the glass dome cool.

4. RADIATION SOURCES.**4.1 General.**

The radiation source may comprise one or more lamps and their associated optical components, e.g., reflectors, filters, etc., to provide the required spectral distribution and irradiance. The high pressure xenon arc lamp with filters can provide the best spectral match. Mercury vapor and xenon-mercury lamps have considerable deficiencies in matching that would lead to error. If not already covered in test method characteristics of these sources, features of filters, optical arrangements, etc., are covered in the following paragraphs. The following general information about several light sources may be helpful.

- a. Xenon lamps. The configuration and size of the lamp(s) used will depend on the test required. The relative spectral distribution of the xenon arc radiation has been found to be substantially independent of lamp power. However, variation of lamp power will change the temperature of the electrodes and hence the spectral distribution of their radiation. With long arc lamps, it is relatively simple to mask off the electrode radiation. The form of construction of the short arc lamp leads to considerably wider manufacturing variation compared with the long arc, a point particularly important when replacement becomes necessary. Routine replacement of either type of lamp will be needed, since the emission will change continuously with life, and there may be wide variations of the life characteristic from lamp to lamp.
- b. Metal Halide (HMI). Metal Halide lamps that are properly filtered and using proper electrical power supply to the lamp can meet the defined spectral requirements. Care must be taken regarding lamp age and lamp power adjustment as spectral shifting can occur leading to changes in spectrum (critical for Procedure II testing).

MIL-STD-810H
METHOD 505.7, ANNEX A

4.2 Filters.

Liquid filters have certain disadvantages such as the possibility of boiling, the temperature coefficient of spectral transmission, and long term drift in spectral characteristics. The present preference is for glass filters to be used, although the characteristics of glass filters are not as accurately reproduced as those of a chemical solution filter. Some trial and error may be necessary to compensate for different optical densities by using different plate thicknesses. Glass filters are proprietary articles and manufacturers should be consulted concerning the choice of filters suitable for particular purposes. The choice will depend on the source and its methods of use. For example, a xenon source may be test-compensated by a combination of infrared and ultraviolet absorbing filters. Some glass infrared filters may be prone to rapid changes in spectral characteristics when exposed to excessive ultraviolet radiation. This deterioration may be largely prevented by interposing the ultraviolet filter between the source and the infrared filter. Interference type filters, that function by reflecting instead of absorbing the unwanted radiation, (thus resulting in reduced heating of the glass), are generally more stable than absorption filters.

4.3 Uniformity of Irradiance.

Owing to the distance of the sun from the Earth, solar radiation appears at the Earth's surface as an essentially parallel beam. Artificial sources are relatively close to the working surface and means of directing and focusing the beam must be provided with the aim of achieving a uniform irradiance at the measurement plane within specification limits (i.e., 1120 W/m² (see Table 505.7-1)). This is difficult to achieve with a short-arc xenon lamp with a parabolic reflector because of shadows from the lamp electrodes and supports. Also, the incandescence of the anode can produce considerable radiation at a much lower color temperature, slightly displaced from the main beam, if only the arc itself is at the focus of the reflector. Uniform irradiation is more readily achieved with a long arc lamp mounted in a parabolic 'trough' type reflector. However, by employing very elaborate mounting techniques, it is possible to irradiate, with some degree of uniformity, a large surface by a number of short arc xenon lamps. It is generally advisable to locate radiation source(s) outside the test enclosure or chamber. This avoids possible degradation of the optical components, e.g., by high humidity conditions, and contamination of test items by ozone that has been generated by xenon and other types of arc lamps. Precise collimation of the radiation beam is not normally required except for testing special materiel such as solar cells, solar tracking devices, etc. However, some of the simulation techniques developed for space research purposes could be adapted for Earth surface solar radiation studies.

5. MEASUREMENTS.

5.1 Measurement of Spectral Distribution.

Total intensity checks are readily made, but detailed checks on spectral characteristics are more difficult. Major spectral changes can be checked by inexpensive routine measurements, using a pyranometer in conjunction with selective filters. For checking the detail spectral distribution characteristics of the facility, it would be necessary to employ sophisticated spectroradiometric instrumentation. However, there seems to be no practical instrumentation obstacle to prevent this calibration being done either as a service by the facility manufacturer or by a visit from a national calibration center. Achieve correlation between the filter/pyranometer and spectroradiometric methods at regular intervals. Changes in the spectral characteristics of lamps, reflectors and filters may occur over a period of time that could result in the spectral distribution being seriously outside the permitted tolerances. Manufacturing tolerances may mean that lamp replacement could result in unacceptable changes in both the level of irradiation and spectral distribution compared with that initially set up. Regular monitoring is therefore essential, but monitoring of the detailed spectral distribution within the test facility may not be possible while an item is undergoing test. A method of measuring the intensity of radiation below 320 nm based on the exposure of polysulphone film and that would permit the monitoring of this wavelength range within the test facility is now established. Lower cost commercially available spectrometers provide reasonable results, however extreme care must be taken when measuring the ultraviolet range. Unless properly calibrated and evaluated, values in the ultraviolet range may be unreliable.

5.2 Measurement of Temperature.

Because of the high level of radiation, it is essential that temperature sensors are adequately shielded from radiant heating effects. This applies both to measuring air temperatures within the test enclosure, and monitoring test item temperatures. When monitoring test item temperatures, sensors, e.g., thermocouples, should be located on the inside surfaces of the external case and should not be attached to the outside surfaces, unless the surface temperature is of concern. Temperature-indicating paints and waxes are unsuitable for monitoring the temperature of irradiated surfaces, since their absorption characteristics will not be the same. Commercially available self-adhesive surface mount thermocouples can be used if properly insulated from the source radiation.

MIL-STD-810H
METHOD 505.7, ANNEX A

Table 505.7A-I. Test parameter tolerances.

Test Parameter	Description	Tolerance
Total Spectral Irradiance	Sum of energy for all spectral bandwidths at a target irradiance level on the test profile (diurnal curve or constant irradiance).	± 4 percent or ± 15 W/m ² (whichever is greater) of the target irradiance.
Spectral energy Distribution	Energy within each spectral bandwidth at a single measurement point.	See Table 505.7-I tolerance for each bandwidth.
Irradiance Uniformity	Deviation between the measured and target irradiance at all measurement points on the target plane. The number of points shall be adequate to define irradiance variation across the target plane(s) to meet the specific test requirement.	± 10 percent deviation from the target irradiance
Instrumentation	Pyranometer, pyrheliometer, or radiometer	See Annex B
Temperature	Chamber control	$+2$ °C ($+3.6$ °F)
Air Speed	Across the test item	1.5 to 3.0 m/sec (300 to 600 ft/min)

6. PREPARATION OF TEST FACILITY AND MATERIEL UNDER TEST.

6.1 Test Facility.

Ensure that the optical parts of the facility, lamps, reflectors, and filters, etc., are clean. The level of irradiation over the specified measurement plane must be measured immediately prior to each test. Throughout the test continually monitor any ancillary environmental conditions, and other parameters as specified in the main body of this Method, paragraphs 4.1 and 4.2d.

6.2 Materiel Under Test.

The method of mounting and the orientation of the test item relative to the direction of radiation will have marked influences on the heating effects. The test item will probably be required to be mounted either on raised supports or on a substrate of specified properties, e.g., a layer of concrete of specified thickness or a sand bed of certain thermal conductivity and reflectivity. Include all this and the attitude of the test item in the relevant specification. Special attention must be paid to the surface conditions of the test item to see that its finish is clean or in accordance with the relevant requirements. The heating effect on the test item will be largely affected by the condition of its external surfaces. Care must therefore be exercised in handling the test item, especially in avoiding oil films and in ensuring that the surface finish and its underlay are fully representative of production standards. Attach temperature sensors to the test item as required (but see also paragraph 5.3 of this Annex).

6.3 Ground Reflected Radiation.

In some cases, such as with a white sand or snow ground cover, and the test item in close association with this surface, significant reflected radiation can be applied to the test item. This effect can be measured using a radiometer designed to measure the "albedo" radiation. This sensor is primarily consists of a upward-facing radiometer and a downward facing radiometer. If the test item is to be substantially used in an environment where ground reflected radiation is a concern, consider the albedo radiation in the test design with radiation provided to the lower surface of the test item by auxiliary lighting, or the use of similar reflective material in the test set up.

7. INTERPRETATION OF RESULTS.

The materiel specification should indicate the permitted changes in the external conditions and/or performance of the test item after exposure to the required level of irradiation for certain durations. In addition, the following aspects of interpretation may be considered:

7.1 Comparison with Field Experience.

The effects of exposing material to solar radiation are well documented (see also paragraphs 7.2 and 7.3 below). Investigate any marked differences between the expected effects and the behavior under test conditions, and the basic cause established, i.e., whether caused by the test equipment or procedure, or by some peculiarity in the test item.

MIL-STD-810H
METHOD 505.7, ANNEX A**7.2 Thermal Effects.**

- a. The maximum surface and internal temperatures attained by materiel will depend on:
 - (1) the temperature of the ambient air.
 - (2) the intensity of radiation.
 - (3) the air velocity.
 - (4) the duration of exposure.
 - (5) the thermal properties of the materiel itself, e.g., surface reflectance, size and shape, thermal conductance, and specific heat.
- b. Materiel can attain temperatures in excess of 60 °C (140 °F) if fully exposed to solar radiation in an ambient temperature as low as 35 to 40 °C (95-104 °F). The surface reflectance of an object affects its temperature rise from solar heating to a major extent; changing the finish from a dark color, for example, to a gloss white will effect a considerable reduction in temperature. Conversely, a pristine finish designed to reduce temperature can be expected to deteriorate in time resulting in an increase in temperature. Most materials are selective reflectors, i.e., their spectral reflectance changes with wavelength. For instance, paints, in general, are poor infrared reflectors although they may be very efficient in the visible region. Furthermore, the spectral reflectance of many materials changes sharply in the visible (producing a color sensation to the human eye) and in the near infrared. It is important, therefore, that the spectral energy distribution of the radiation source(s) used in any simulated test should closely duplicate that of natural radiation.

7.3 Degradation of Materials.

The combined effects of solar radiation, atmospheric gases, temperature, humidity changes, etc., are often collectively termed “weathering,” and result in the “ageing” and ultimate destruction of most organic materials (e.g., plastics, rubbers, paints, timber, etc.). Many materials that give satisfactory service in temperate regions have been found to be completely unsuitable for use under more adverse conditions. Typical effects are the rapid deterioration and breakdown of paints, the cracking and disintegration of cable sheathing, and the fading of pigments. The breakdown of a material under weathering usually results not from a single reaction, but from several individual reactions of different types occurring simultaneously, often with interacting effects. Although solar radiation, principally the ultraviolet portion, resulting in photodegradation is often the major factor, its effects can seldom be separated, in practice, from those of other weathering factors. An example is the effect of ultraviolet radiation on polyvinyl chloride, where the apparent effects of ultraviolet radiation alone are small, but its susceptibility to thermal breakdown, in which oxygen probably plays a major role, is markedly increased. Unfortunately, artificial tests occasionally produce abnormal defects that do not occur under weathering. This can be often attributed to one or more of the following causes:

- a. Many laboratory sources of ultraviolet radiation differ considerably from natural solar radiation in spectral energy distribution.
- b. When the intensity of ultraviolet, temperature, humidity, etc., are increased to obtain accelerated effects, the rate of the individual reactions (that occur under normal exposure conditions), are not necessarily increased to the same extent. In some cases, e.g., fluorescent lamps, the infrared energy of the source is significantly less than that of true solar loading, resulting in a surface test temperature that is lower than would be experienced out-of-doors.
- c. The artificial tests, in general, do not simulate all the natural weathering factors.

MIL-STD-810H
METHOD 505.7, ANNEX A**8. HAZARDS AND PERSONNEL SAFETY.****8.1 General.**

The complex equipment employed for solar radiation testing purposes will necessarily call for operation and maintenance by a skilled test staff, not only to ensure the prescribed performance of the test, but also because of the various health and safety hazards that have to be considered.

8.2 Ultraviolet Radiation.

The most obvious dangers that have to be guarded against are those associated with the harmful effects of high intensity radiation in the near ultraviolet region. In natural sunlight, the eyes are protected in two ways: the brightness of the sun makes it almost impossible to look directly at it and the ultraviolet radiation is considerably attenuated by the atmosphere. These protections may not apply to artificial sources. Due to the point sources and high UV component of these sources, the eyes must be protected by filtered goggles or viewing apertures, particularly when setting up the equipment. Warn all testing personnel that severe eye damage can result from only short exposure to unfiltered radiation from arc-type lamps. Serious erythema (sunburn) of exposed skin will also occur. Koller (paragraph 6.1, reference c) states the ultraviolet radiation of sunlight is a major causal factor in cancer of the skin in the white population of the US. The use of suitable protective clothing including protection of the head and hands is highly recommended, even when working in test enclosures irradiated by filtered sources.

8.3 Ozone and Harmful Fumes.

Another serious health hazard arising from the use of xenon and other arc lamps is the possible buildup of local toxic concentrations of ozone during the testing period. However, the maximum production of ozone occurs at the initial switching on of the lamp, and thereafter the hot envelope of the lamp tends to degrade the ozone back to oxygen. Where forced-air cooling is employed, this cooling air should be removed from the building and not blown into the lamp housing. In this way, the ozone hazard can be largely eliminated. Suitable detecting and measuring equipment is commercially available. The combined effects of heat and ultraviolet radiation on certain plastics (e.g., melamine laminates) may also produce toxic fumes. Take particular care in the choice of materials used in the construction of a test facility.

8.4 Risk of Lamp Explosions.

The use of high pressure xenon discharge lamps as the primary radiation source can also result in serious accidents unless a well planned code of practice for the handling of these arc discharge tubes has been specified and is adhered to. All such lamps (whether hot or cold, used or new) have a liability to explode violently by reason of the considerable internal pressure (two to three atmospheres when cold, but up to twenty atmospheres when hot). There should be no visible dirt or oil on the envelope, so regular cleaning with detergent and alcohol is necessary using cotton gloves and face protection during such cleaning. When cold lamps are to be stored, the effects of explosion may be limited by two layers of 0.25 mm thick polycarbonate sheet. Particular care must be taken to limit the spread of chain reaction breakdowns in multi-lamp equipment. It is possible to use armor plate glass for the dual purpose of protection against lamp explosions and as a corrective filter. Individual lamp records should be kept as a matter of routine so as to be able to detect abnormal voltage/current behavior.

8.5 Electric Shock.

Normal electric shock preventive measures must, of course, be adopted, particularly in the case of the high voltage igniter systems used with arc lamps. In some xenon lamps, the arc ignition pulse exceeds 60 kV, and an interlock system is therefore essential.

MIL-STD-810H
METHOD 505.7, ANNEX A

(This page is intentionally blank.)

MIL-STD-810H
METHOD 505.7, ANNEX B**METHOD 505.7 ANNEX B****INSTRUMENTATION INSTALLATION, PLACEMENT AND GUIDANCE****INSTRUMENTATION.**

- a. Measurement of Irradiance. The type of instrument considered most suitable for measuring/monitoring the irradiance during test set up and test operation is the pyranometer. The pyranometer is designed for measuring the irradiance (radiant-flux, watts/m²) on a plane surface that results from direct solar radiation and from the diffuse radiation incident from the hemisphere above. ISO-9060 (paragraph 6.1, reference d), provides additional information regarding definitions, design criteria, and proper use.
- b. Pyranometer Classifications.
 - (1) Referring to ISO-9060, the pyranometer used for testing should be critically selected based on the specific internal requirements for internal tractability/calibration certification, and the ability of the selected pyranometer to meet the requirements of the test and test process (see ISO 9060, Table 1 for classification details, paragraph 4.3.2, "Classification Criteria").
 - (2) In tests where a direct traceability chain is required, recommend a pyranometer meeting the classification of "secondary standard." For typical test set-up and operation, a classification of "First Class Instrument" is generally sufficient. As a minimum, calibrate all instruments on an annual basis.
- c. Pyranometer Use Guidelines.
 - (1) Pyranometers are used for validating irradiance values during test set-up, for pre-test, during the test, and post test to confirm the specified radiant energy values are maintained. Recommended the interval used for radiant energy level verification during a test be once per day, OR as required based on historical statistical charting showing test compliance for longer periods. For Procedure I, in addition to recording the pretest calibration, it is recommended to record the intensity level at a sufficient interval to verify the proper radiation intensity is achieved throughout the cycle. For Procedure II, in addition to recording the pretest calibration, it is recommended to record the intensity once per-cycle and verify the UVa and UVb portions of the spectrum every seventh cycle.
 - (2) If pyranometers are continuously exposed to the solar radiation source, consider thermal drift of the radiant energy values provided by the pyranometer. Some pyranometers require a thermal offset value based on temperature, while others have internal offset characteristics that minimize thermal drift.
 - (3) Periodic calibration certification of pyranometers is required, typically once per-year or as specified by the pyranometer manufacturer. The pyranometer calibration is to be certified in accordance to ISO-9847, paragraph 6.1, reference e, or ASTM E-824, paragraph 6.1, reference f.
 - (4) Proper mounting, mounting location, and horizontal placement of the pyranometer are critical to achieving proper evaluation of the test item. The testing parties must agree to the mounting of the pyranometer for the test, with mounting location and method recorded as part of the permanent test record.
- d. Evaluation of Spectral Power Distribution (SPD). Measuring and monitoring spectral power distribution of the lamp demonstrates compliance with Table 505.7-I. Ensure the SPD measurement system is calibrated and operating properly for accuracy, especially in the ultraviolet range. Instrument accuracy can be found in Table 505.7B-I. Spectral power distribution evaluation guidelines:
 - (1) SPD measurements are critical for simulated solar testing. The pre and post test results should be documented in the final test report.
 - (2) Often SPD measurement devices are limited to a maximum range of 800 nm or 1100 nm, and the pyranometer reading is used to algebraically calculate the energy in the infrared range (780 nm-3000 nm).

MIL-STD-810H
METHOD 505.7, ANNEX B**Table 505.7B-I. Instrument accuracy.**

Measurement Instrument	Parameter Measured	Tolerance
Pyranometer/Pyrheliometer	Total irradiation (direct and scattered)	Secondary Standard in accordance with ISO 9060
Spectroradiometer or Filtered Pyranometer	Spectral distribution	± 4 percent over the specified radiometric band

NOTE: A filtered pyranometer may not provide a satisfactory resolution in the ultraviolet range.

MIL-STD-810H
METHOD 505.7, ANNEX C

METHOD 505.7 ANNEX C
GUIDANCE ON TABLES AND FIGURES

The following is a copy of Table 505.7-I in the main body of this Method. Inserting it here facilitates discussion on its use in calculating points on the curve in Figure 505.7-1.

Table 505.7C-I. Spectral energy distribution and permitted tolerance.

Spectral Region	Bandwidth (nm)	Natural Radiation (% of total)	Tolerance (% of total)		Irradiance (W/m ²)	Spectral Region Irradiance (W/m ²)
			Min	Max		
Ultraviolet - B	280-320	0.5	0.3	0.7	5.6	5.6
Ultraviolet - A	320-360	2.4	1.8	3	26.9	62.7
	360-400	3.2	2.4	4.4	35.8	
Visible	400-520	17.9	16.1	19.7	200.5	580.2
	520-640	16.6	14.9	18.3	185.9	
	640-800	17.3	12.8	19	193.8	
Infrared	800-3000	42.1	33.7	50.5	471.5	471.5
Totals					1120	1120

Compliance to solar radiation requirements covers two main elements, providing the recommended spectral power distribution of the light source, and providing the correct irradiance levels over the specified surface of the test item.

The information in Table 505.7-I is used to determine the capability of the artificial light source to produce a satisfactory spectrum for use in solar simulation testing.

Table 505.7A-I provides guidance for on-sample test level simulated solar radiation intensity and uniformity target values.

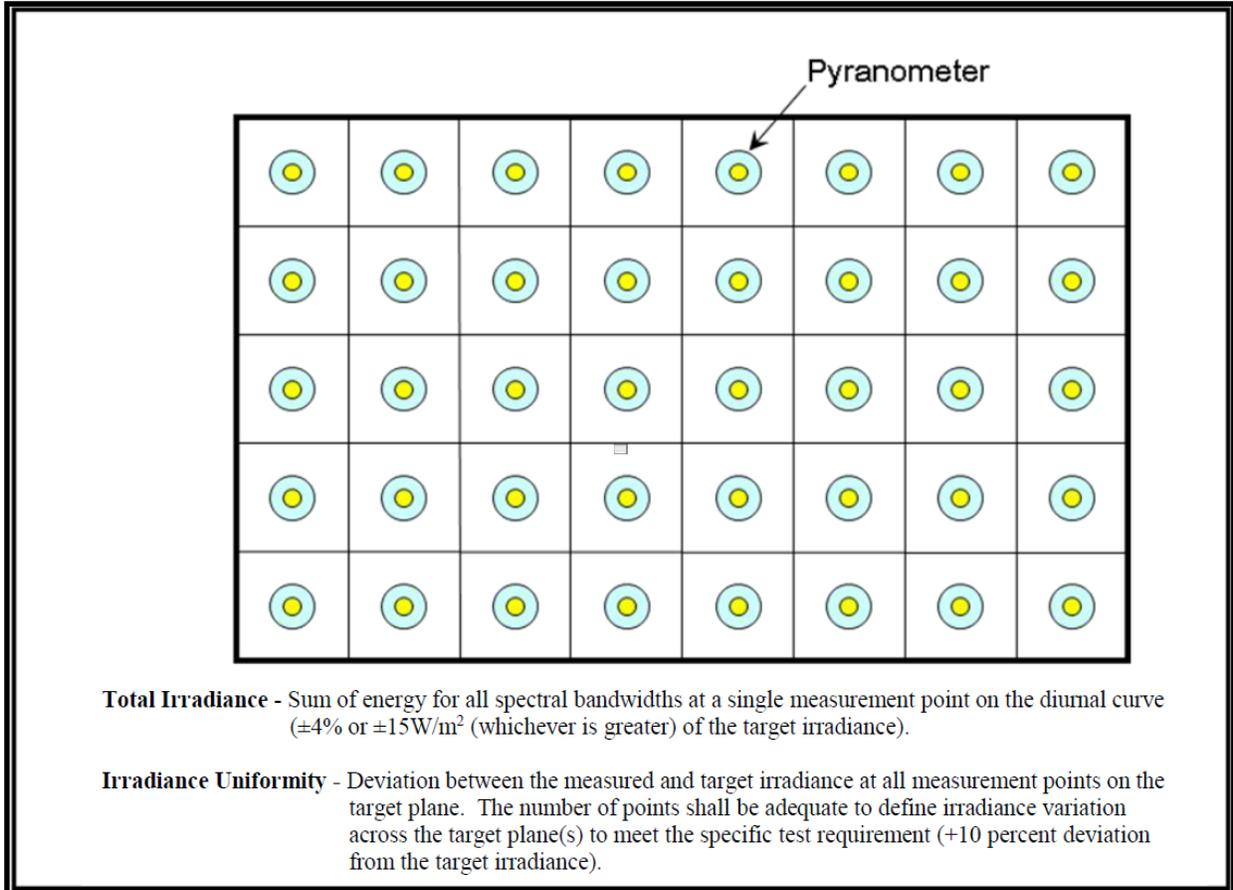
Definition: Spectral Power Distribution: The relative power emitted by a source as a function of wavelength. (See paragraph 6.1, reference g.)

EXAMPLES.

The following examples are to illustrate possible test configurations and instrument placement. As each test is performed to accomplish specific evaluations and address specific system performance criteria, these examples is for illustration only with actual test configuration to be performed according to the test plan and as agreed between the contractual parties.

- a. When setting up a solar radiation test the following steps can be employed:
 - (1) Establish a ± 10 percent uniformity value over an established test plane appropriate for the test item. A grid pattern appropriate for the size of the test item is established, and the solar radiation system is adjusted to provide a uniform exposure over the test plane. During this process, either multiple radiometers or a single radiometer is used and moved to positions required for solar radiation uniformity verification.

MIL-STD-810H
METHOD 505.7, ANNEX C



NOTE: Grid size is typically unique to the chamber dimensions and solar simulator design.

Figure 505.7C-1. Example of establishing target and uniformity levels over surface target plane.

MIL-STD-810H
METHOD 505.7, ANNEX C

- (2) If the test item is available, the test can be run using an established test plane or the actual surface of the test item. The test plane approach is best if the test item surfaces are in a reasonably horizontal plane with minimal height differences.

When the actual test surface is used for test set-up, a grid pattern is applied to the primary surfaces to establish solar radiation uniformity and, if desired, radiometers are placed at reference locations during the test to record and monitor radiation levels during the test.

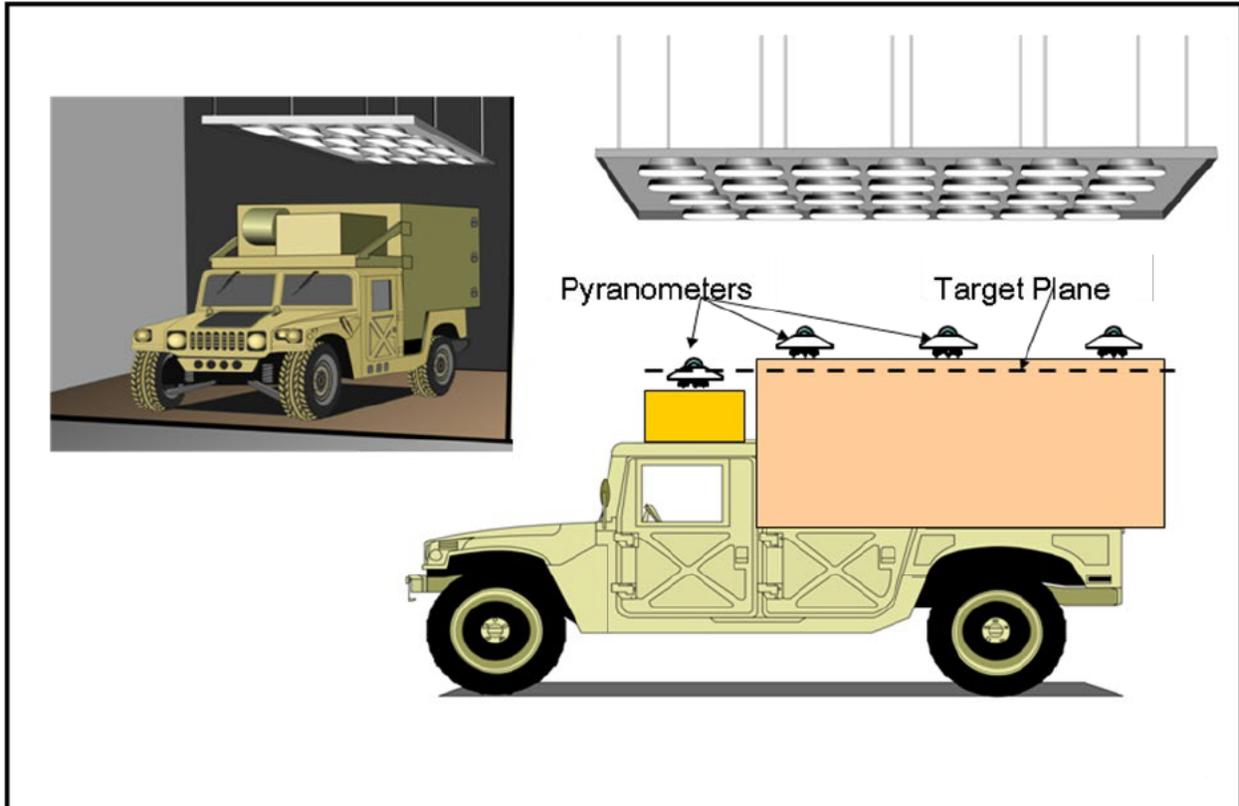


Figure 505.7C-2. Example 1 – Flat surface exposure.

MIL-STD-810H
METHOD 505.7, ANNEX C

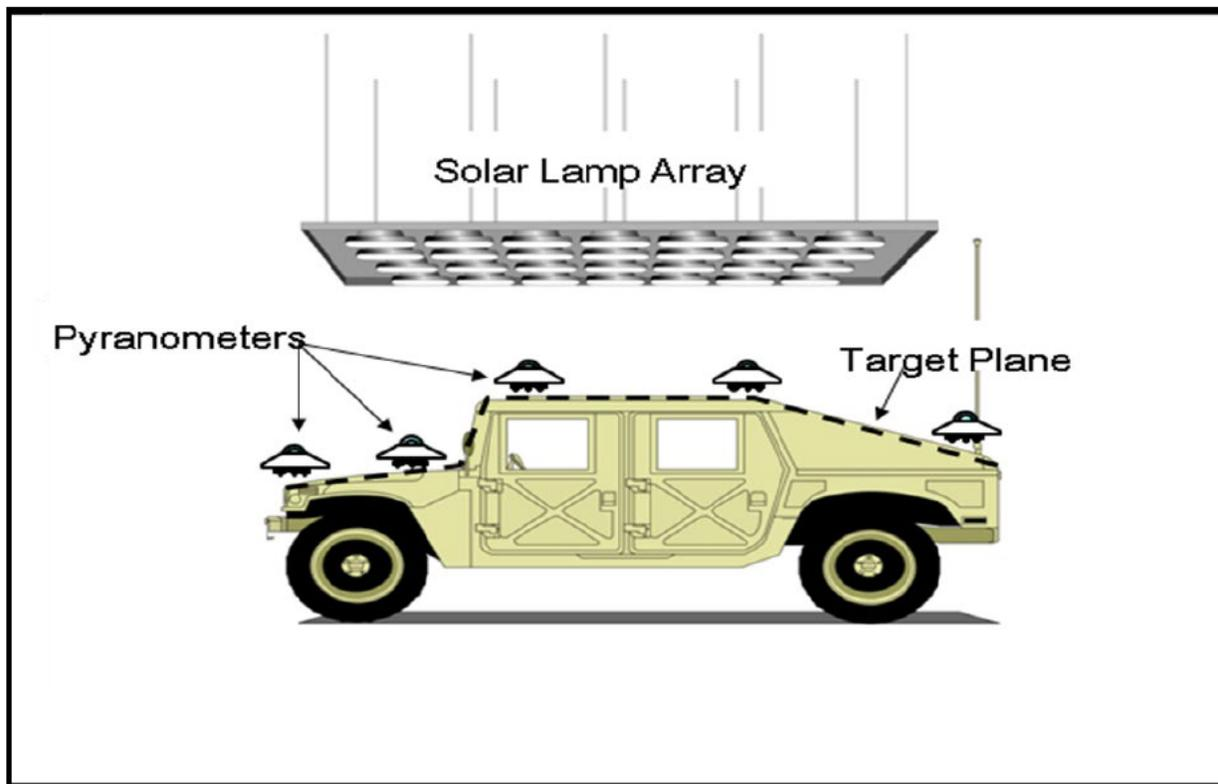


Figure 505.7C-3. Example 2 - Test item surface shape exposure.

MIL-STD-810H
METHOD 505.7, ANNEX C

- (3) Test items with extreme height differences may require multiple test planes. For example, if a system has a raised antenna and an electronics enclosure at a lower height, a multiple test plane configuration would allow the best test results. In this case the upper test plane will receive the proper radiation by the main overhead simulated solar source, and an auxiliary simulated solar source is needed to provide the correct radiation level to the secondary test plane.

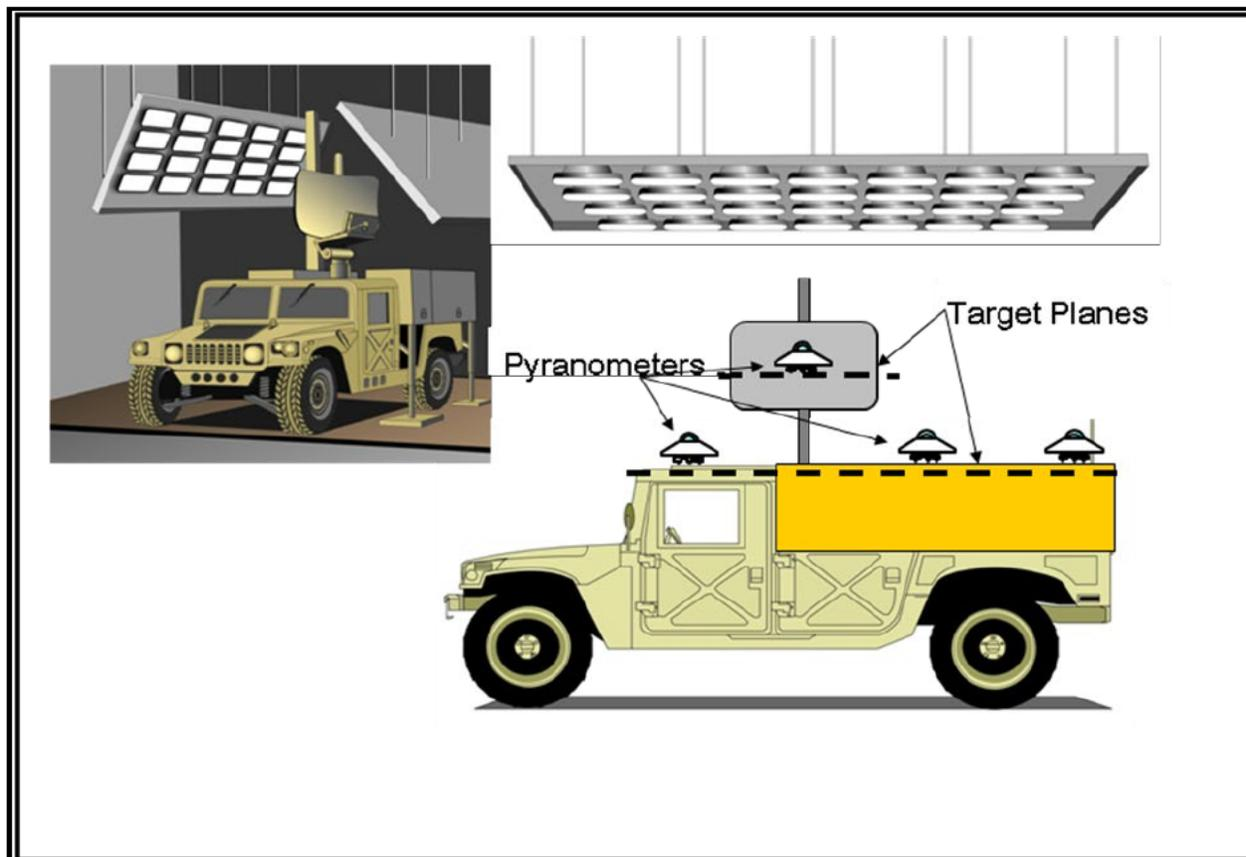


Figure 505.7C-4. Example 3 - Multiple solar surface target planes.

- (4) Example of how to calculate the Spectral Power Distribution at a given total irradiance level with reference to Table 505.7-I.

MIL-STD-810H
METHOD 505.7, ANNEX C

Table 505.7C-II. Example calculation of spectral energy distribution and permitted tolerance.

Spectral Region	Bandwidth (nm) ²	Natural Radiation (% of total) ²	Tolerance (% of total) ²		Calculated Irradiance Tolerances For a Given Total Irradiance (W/m ²) → 822.5¹				
			Min	Max	Nominal	Min		Max	
Ultraviolet - B	280-320	0.5	0.3	0.7	4.1	2.5	2.5	5.8	5.8
Ultraviolet - A	320-360	2.4	1.8	3	19.7	14.8	34.5	24.7	60.9
	360-400	3.2	2.4	4.4	26.3	19.7		36.2	
Visible	400-520	17.9	16.1	19.7	147.2	132.4	360.3	162	468.8
	520-640	16.6	14.9	18.3	136.5	122.6		150.5	
	640-800	17.3	12.8	19	142.3	105.3		156.3	
Infrared	800-3000	42.1	33.7	50.5	346.3	277.2	277.2	415.4	415.4

Note: 1. The sum of energy in all spectral bands shall not exceed $\pm 4\%$ of total irradiance or ± 15 W/m² (whichever is greater)

2. The values in columns 2 through 5 were obtained from CIE-85 and DIN 75220, Table 1.

Spectral compliance is determined by measurement of individual bandwidth energy. The Table 505.7C-II right side provides calculated maximum and minimum bandwidth energy for the fifth step of Figure 505.7C-5 with a total energy of 822.5 W/m². Individual bandwidth energy may be greater or less than the nominal value, however the irradiance sum must also be within $\pm 4\%$ of the total nominal irradiance. Application of the $\pm 4\%$ tolerance to the target irradiance of 822.5 W/m² results in the required product between 789.6 to 855.4 W/m². Spectral compliance must be evaluated based on a single measurement point, not an average or composite of multiple points. The natural radiation energy/bandwidth percentage is the same for each diurnal cycle step as shown by comparison with Table 505.7C-I. The equations below are applicable to calculate energy in a partial bandwidth region for any total irradiance. The individual bandwidth energy minimum and maximum can be used to evaluate lamp degradation or the influence of multiple lamp types on spectral compliance.

For each bandwidth:

$$\text{Nominal Irradiance} = \text{Total Irradiance} \times \frac{\text{Natural Radiation (\% of total)}}{100\%}$$

$$\text{Min Irradiance} = \text{Total Irradiance} \times \frac{\text{Tolerance (\% of total) Min}}{100\%}$$

$$\text{Max Irradiance} = \text{Total Irradiance} \times \frac{\text{Tolerance (\% of total) Max}}{100\%}$$

Therefore, for a total irradiance of 822.5 W/m² the tolerances for the Ultraviolet-B (UVB) band would be:

$$\text{Nominal Irradiance} = 822.5 \frac{\text{W}}{\text{m}^2} \times \frac{0.5\%}{100\%} = 4.1125 \frac{\text{W}}{\text{m}^2} \cong 4.1 \frac{\text{W}}{\text{m}^2}$$

$$\text{Min Irradiance} = 822.5 \frac{\text{W}}{\text{m}^2} \times \frac{0.3\%}{100\%} = 2.4675 \frac{\text{W}}{\text{m}^2} \cong 2.5 \frac{\text{W}}{\text{m}^2}$$

$$\text{Max Irradiance} = 822.5 \frac{\text{W}}{\text{m}^2} \times \frac{0.7\%}{100\%} = 5.7575 \frac{\text{W}}{\text{m}^2} \cong 5.8 \frac{\text{W}}{\text{m}^2}$$

MIL-STD-810H
METHOD 505.7, ANNEX C

The second criteria is a uniform irradiance across a test item surface area (target plane). Method 505 uses the term “uniformity”, other documents may reference “non-uniformity”. Both terms define a deviation between measured and desired irradiance across positions on a measurement grid. A test item may have multiple grids or intensity requirements, but the basic evaluation is the same. The uniformity evaluation can be performed with an imaginary surface prior to placement of the test item in the chamber. Alternatively, measurements can be performed on the test item if pre-test irradiance exposure is acceptable. In either case, documentation of measurement grid points and irradiance is required to validate the test setup uniformity.

The central 3 x 4 target plane in Figure 505.7C-1 represents the Figure 505.7C-2 vehicle top surface. Each pyranometer represents one portion of the target plane area, additional pyranometers are distributed around the target plane. Figures 505.7C-3 and 505.7C-4 illustrate additional test configurations and target planes. Accurate uniformity for the vehicle antenna and lower electronics enclosure is best represented by a multiple target plane configuration. The upper plane receives irradiance from the main overhead array, and an auxiliary array is needed to provide irradiance to the lower plane. Screen mesh or other material above higher components can also be used to attenuate irradiance. The test configurations are for illustration only, actual testing must be performed according to the test plan and as agreed between the contractual parties.

MIL-STD-810H
METHOD 505.7, ANNEX C

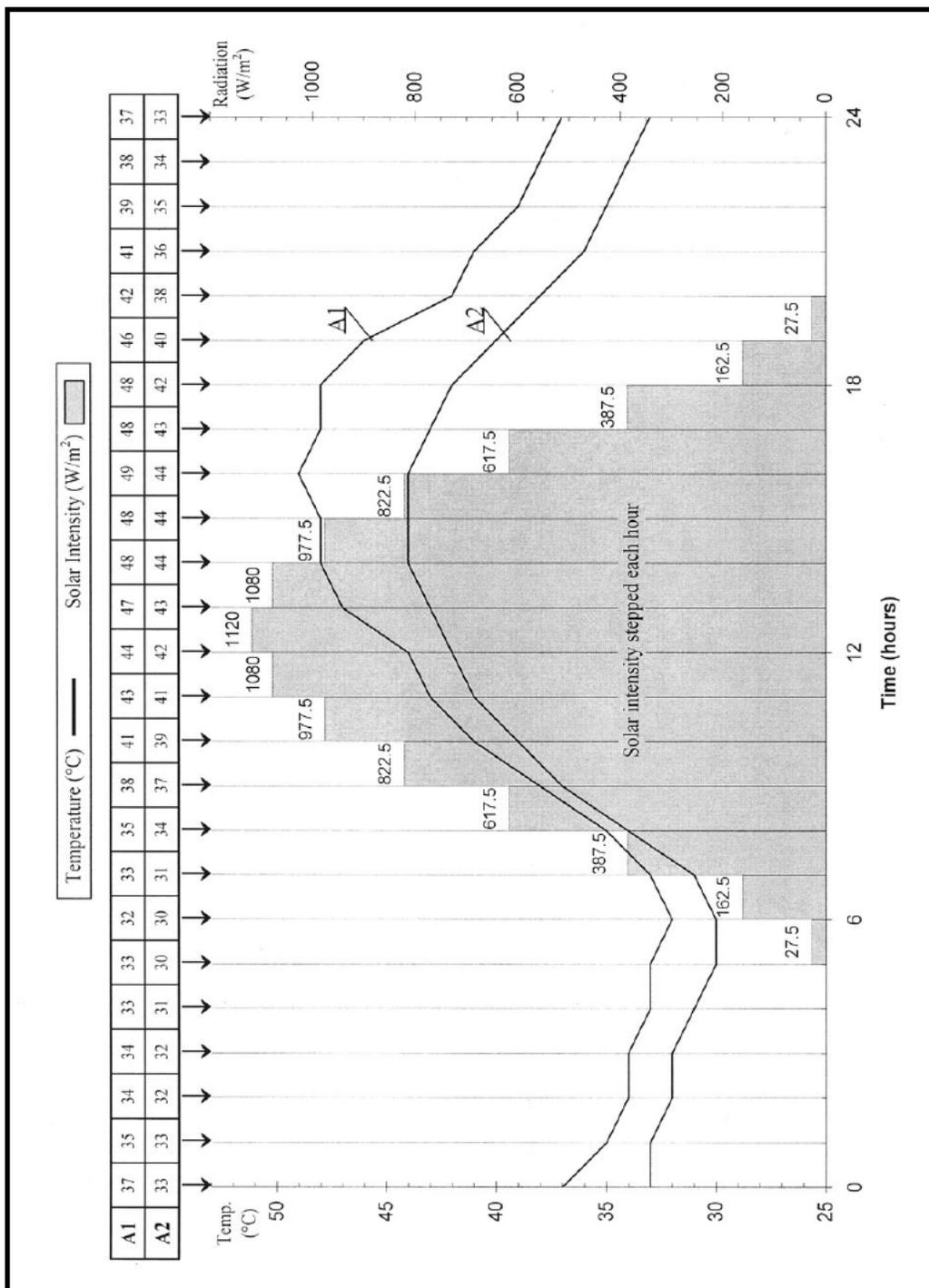


Figure 505.7C-5. Method for conducting Procedure I with solar radiation controlled in one-hour steps.

MIL-STD-810H
METHOD 505.7, ANNEX C

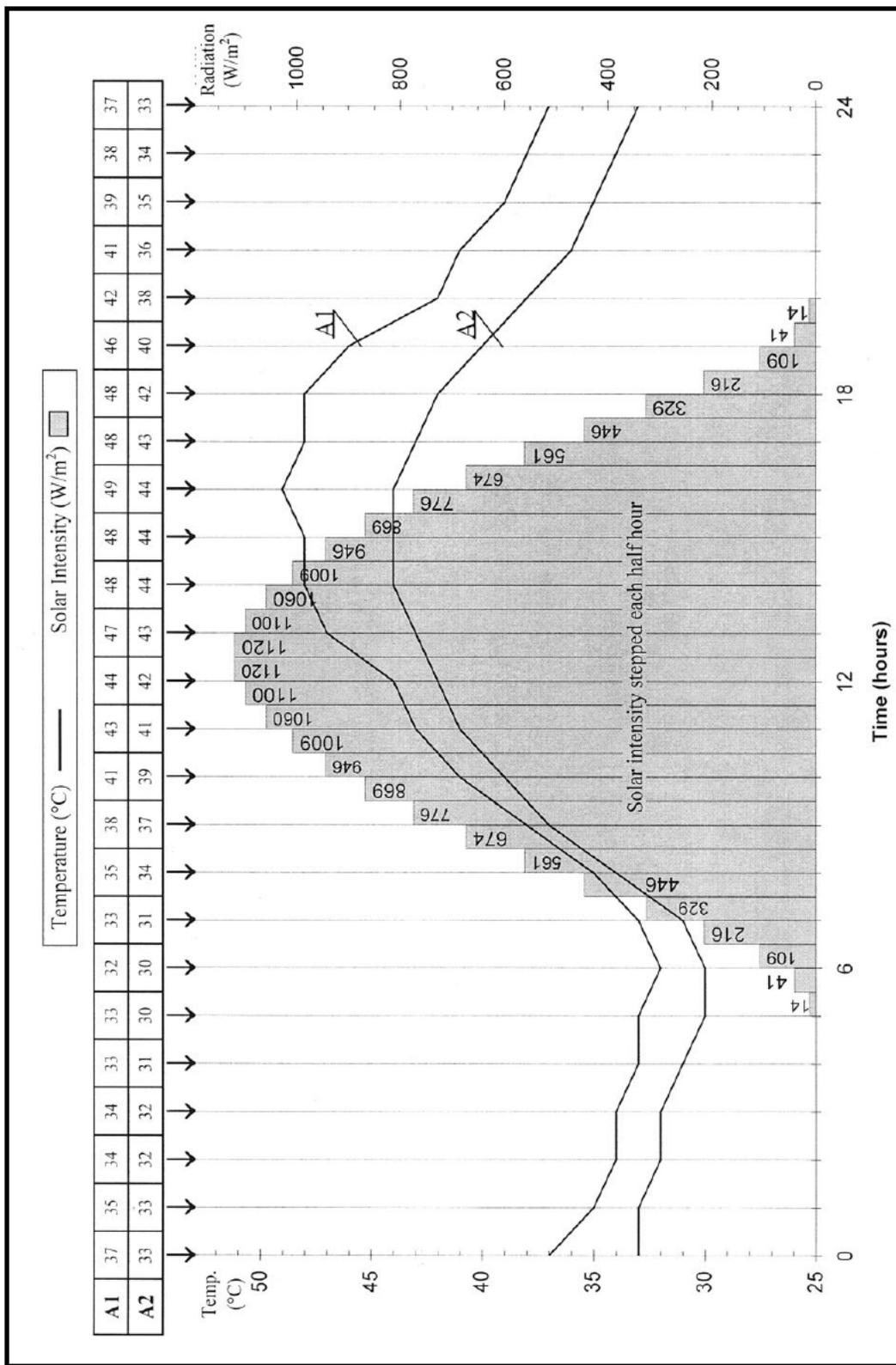


Figure 505.7C-6. Method for conducting Procedure I with solar radiation controlled in half-hour steps.

MIL-STD-810H
METHOD 506.6

METHOD 506.6

RAIN

CONTENTS

<u>Paragraph</u>	<u>Page</u>
1. SCOPE	1
1.1 PURPOSE	1
1.2 APPLICATION	1
1.3 LIMITATIONS	1
2. TAILORING GUIDANCE	2
2.1 SELECTING THE RAIN METHOD	2
2.1.1 EFFECTS OF RAIN ENVIRONMENTS	2
2.1.1.1 IN THE ATMOSPHERE	2
2.1.1.2 ON IMPACT	2
2.1.1.3 AFTER DEPOSITION AND/OR PENETRATION	2
2.1.2 SEQUENCE AMONG OTHER METHODS	2
2.2 SELECTING PROCEDURES	3
2.2.1 PROCEDURE SELECTION CONSIDERATIONS	3
2.2.2 DIFFERENCE AMONG PROCEDURES	3
2.3 DETERMINE TEST LEVELS AND CONDITIONS	3
2.3.1 TEST ITEM CONFIGURATION	3
2.3.2 RAINFALL / DRIP RATE	4
2.3.3 DROPLET SIZE	4
2.3.4 WIND VELOCITY	4
2.3.5 TEST ITEM EXPOSURE SURFACE (ORIENTATION)	5
2.3.6 WATER PRESSURE	5
2.3.7 PREHEAT TEMPERATURE	5
2.3.8 EXPOSURE DURATION	5
3. INFORMATION REQUIRED	5
3.1 PRETEST	5
3.2 DURING TEST	5
3.3 POST-TEST	6
4. TEST PROCESS	6
4.1 TEST FACILITY	6
4.1.1 PROCEDURE I - RAIN AND BLOWING RAIN	6
4.1.2 PROCEDURE II - EXAGGERATED	7
4.1.3 PROCEDURE III - DRIP	8
4.2 CONTROLS	9
4.3 TEST INTERRUPTION	10
4.3.1 INTERRUPTION DUE TO CHAMBER MALFUNCTION	10
4.3.2 INTERRUPTION DUE TO TEST ITEM OPERATION FAILURE	10
4.4 TEST EXECUTION	10
4.4.1 PREPARATION FOR TEST	10
4.4.1.1 PRELIMINARY STEPS	10
4.4.1.2 PRETEST STANDARD AMBIENT CHECKOUT	10
4.4.2 PROCEDURE I - RAIN AND BLOWING RAIN	10
4.4.3 PROCEDURE II - EXAGGERATED	11
4.4.4 PROCEDURE III - DRIP	11

MIL-STD-810H
METHOD 506.6

<u>Paragraph</u>	<u>Page</u>
5. ANALYSIS OF RESULTS	11
5.1 OPERATIONAL FAILURE	12
5.2 WATER PENETRATION.....	12
6. REFERENCE/RELATED DOCUMENTS	12
6.1 REFERENCED DOCUMENTS.....	12
6.2 RELATED DOCUMENTS.....	12

FIGURES

FIGURE 506.6-1 SAMPLE FACILITY FOR STEADY STATE RAIN OR DRIP TEST	7
FIGURE 506.6-2 TYPICAL NOZZLE SETUP FOR EXAGGERATED TEST, PROCEDURE II (NOT INTENDED FOR USE WHEN CONDUCTING PROCEDURE I TESTING).....	8
FIGURE 506.6-3 DETAILS OF DISPENSER FOR DRIP TEST, PROCEDURE III	9

MIL-STD-810H
METHOD 506.6**METHOD 506.6****RAIN**

NOTE: Tailoring is essential. Select methods, procedures and parameter levels based on the tailoring process described in Part One, paragraph 4.2.2, and Annex C. Apply the general guidelines for laboratory test methods described in Part One, paragraph 5 of this standard.

1. SCOPE.**1.1 Purpose.**

The purpose of this Method is to help determine the following with respect to rain, water spray, or dripping water:

- a. The effectiveness of protective covers, cases, and seals in preventing the penetration of water into the materiel.
- b. The capability of the materiel to satisfy its performance requirements during and after exposure to water.
- c. Any physical deterioration of the materiel caused by the rain.
- d. The effectiveness of any water removal system.
- e. The effectiveness of protection offered to a packaged materiel.

1.2 Application.

Use this Method to evaluate materiel likely to be exposed to rain, water spray, or dripping water during storage, transit, or operation. If the materiel configuration is the same, the immersion (leakage) test (Method 512.6) is normally considered to be a more severe test for determining if water will penetrate materiel. There is generally no need to subject materiel to a rain test if it has previously passed the immersion test and the configuration does not change. However, there are documented situations in which rain tests revealed problems not observed during immersion tests due to differential pressure. Additionally, the immersion test may be more appropriate if the materiel is likely to be placed on surfaces with significant amounts of standing water. In most cases, perform both tests if appropriately identified in the life cycle profile.

1.3 Limitations.

- a. When a requirement exists for weapon system components such as seeker windows/radomes, nose cones, airframes, leading edges, control surfaces, thermal protection systems, and fuzes to operate during weather encounter to include high speed flight through hydrometeors, a tailored test approach must be utilized based on the system configuration, trajectories, and system specific statistically based weather occurrence. Traceability must be addressed between realistic flight through weather and ground test methods to ensure adequate performance characterization is achieved. Ground test methods include the use of nylon bead impact, single water drop impact, whirling-arm impact, ballistic gun ranges, and sled track facilities with rain field simulation capability to induce high speed/hypersonic integrated rain impact/erosion effects on flight components. For hypersonic item testing consider utilizing the methods described in Technical Report AMR-PS-08-01.
- b. Because of the finite size of the test facilities, it may be difficult to determine atmospheric rain effects such as on electromagnetic radiation and propagation.
- c. This Method is not intended for use in evaluating the adequacy of aircraft windshield rain removal provisions.
- d. This Method doesn't address pressure washers or decontamination devices.
- e. This Method may not be adequate for determining the effects of extended periods of exposure to rain, or for evaluating materiel exposed to only light condensation drip rates (lower than 140 L/m²/hr) caused by an overhead surface. For this latter case, the aggravated humidity cycle of Method 507 will induce a significant amount of free water on both inside and outside surfaces.

MIL-STD-810H
METHOD 506.6**2. TAILORING GUIDANCE.****2.1 Selecting the Rain Method.**

After examining the requirements documents and applying the tailoring process in Part One of this Standard to determine where rain is foreseen in the life cycle of the materiel, use the following to aid in selecting this Method and placing it in sequence with other methods. The term "rain" encompasses the full range of "free water" (blowing, steady state, drip) tests included in this Method.

2.1.1 Effects of Rain Environments.

Rain (when falling, upon impact, and as deposited as pooled water) has a variety of effects on materiel. Consider the following typical problems to help determine if this Method is appropriate for the materiel being tested. This list is not intended to be all-inclusive, and some of the examples may overlap the categories.

2.1.1.1 In the Atmosphere.

In the atmosphere the effects resulting from exposure to these environments include:

- a. Interference with or degradation of radio communication.
- b. Limited radar effectiveness.
- c. Limited aircraft operations due to restricted visibility and decreased lift from wing surfaces (excessive rain rates only).
- d. Damage to aircraft in flight.
- e. Affect on munitions launch and flight.
- f. Degradation or negation of optical surveillance.
- g. Decreased effectiveness of personnel in exposed activities.
- h. Premature functioning of some fuses.
- i. Inhibited visibility through optical devices.

2.1.1.2 On Impact.

On impact it erodes surfaces.

2.1.1.3 After Deposition and/or Penetration.

After deposition and/or penetration, the effects resulting from exposure to these environments include:

- a. Degraded strength/swelling of some materials.
- b. Increased corrosion potential, erosion, or even fungal growth.
- c. Increased weight.
- d. Electrical or electronic apparatus become inoperative or unsafe.
- e. Malfunction of electrical materiel.
- f. Freezing inside materiel that may cause delayed deterioration and malfunction by swelling or cracking of parts.
- g. Modified thermal exchange.
- h. Slower burning of propellants.

2.1.2 Sequence Among Other Methods.

- a. General. Use the anticipated life cycle sequence of events as a general sequence guide (see Part One, paragraph 5.5).
- b. Unique to this Method. This Method is applicable at any stage in the test program, but its effectiveness in determining the integrity of an enclosure is maximized if it is performed after the dynamic tests.

MIL-STD-810H
METHOD 506.6**2.2 Selecting Procedures.**

This Method includes three rain-related test procedures: Procedure I (Rain and Blowing Rain), Procedure II (Exaggerated), and Procedure III (Drip). Before conducting the test, determine which test procedure(s) and test conditions are appropriate.

2.2.1 Procedure Selection Considerations.

Differences among rain test procedures are explained below. Select the procedure that represents the most severe exposure anticipated for the materiel commensurate with materiel size. When selecting a procedure, consider:

- a. The materiel configuration.
- b. The logistical and operational requirements (purpose) of the materiel.
- c. The operational purpose of the materiel and data to verify it has been met.
- d. The natural exposure circumstances.
- e. Procedure sequence.

2.2.2 Difference Among Procedures.

- a. Procedure I - Rain and Blowing Rain. Procedure I is applicable for materiel that will be deployed out-of-doors and that will be unprotected from rain or blowing rain. The accompanying wind velocity can vary from almost calm to extremely high. Consider using Procedure II for materiel that cannot be adequately tested with this procedure because of its (large) size.
- b. Procedure II - Exaggerated. Consider Procedure II when large (shelter-size) materiel is to be tested and a blowing-rain facility is not available or practical. This procedure is not intended to simulate natural rainfall but will provide a high degree of confidence in the watertightness of materiel.
- c. Procedure III - Drip. Procedure III is appropriate when materiel is normally protected from rain but may be exposed to falling water from condensation or leakage from upper surfaces. There are two variations to the drip test:
 - (1) for materiel that may experience falling water (generally from condensation), and
 - (2) for materiel that may be subjected to heavy condensation or leaks from above.

2.3 Determine Test Levels and Conditions.

Having selected this Method and relevant procedures (based on the materiel's requirements documents and the tailoring process), it is necessary to complete the tailoring process by selecting specific parameter levels and special test conditions/techniques for these procedures based on requirements documents or Life Cycle Environmental Profile (LCEP) (see Part One, Figure 1-1), and information provided with this procedure. From these sources of information, determine the functions to be performed by the materiel in rain environments or following storage in rain environments. Then determine the rainfall levels of the geographical areas and micro-environments in which the materiel is designed to be employed. Variables under each test procedure include the test item configuration, rainfall rate, wind velocity, test item exposure surfaces, water pressure, and any additional appropriate guidelines in accordance with the requirements document.

2.3.1 Test Item Configuration.

Perform the test using all the configurations in which the materiel may be placed during its life cycle. As a minimum, consider the following configurations:

- a. In a shipping/storage container or transit case.
- b. Protected or not protected.
- c. In its operational configuration.
- d. Modified with kits for special applications.

MIL-STD-810H
METHOD 506.6

NOTE: Do not use any sealing, taping, caulking, etc., except as required by the design specification for the materiel. Unless otherwise specified, do not use test items that have surface contamination such as oil, grease, or dirt that could prevent wetting.

2.3.2 Rainfall / Drip Rate.

- a. **Procedure I – Rain and Blowing Rain:** The rainfall rate used in Procedure I may be tailored to the anticipated deployment locale and duration. Although various rainfall intensities have been measured in areas of heavy rainfall, recommend a minimum rate of 1.7 mm/min (4 in/hr) since it is not an uncommon occurrence, and would provide a reasonable degree of confidence in the materiel. MIL-HDBK-310 (paragraph 6.1, reference a) contains further information. During the pretest set-up, rain fall measurements should be taken at a minimum of 5 random locations. The average of these rain rate measurements should be within 10% or +/- 0.1 mm/min (0.25 in/hr) of the specified value, whichever is less. To ensure a uniform distribution of simulated rain on the test item each measurement should be within 25% or +/- 0.2 mm/min (0.5 in/hr) of the specified rain rate whichever is less.
- b. **Procedure II - Exaggerated:** This procedure uses (as a guideline) a 276 kPa (40 psig) nozzle pressure with a flow rate of 20.8 L/min (5.5 gal/min) that should produce water droplets traveling at approximately 64 km/h (40 mph) when using a nozzle such as specified in paragraph 4.1.2.
- c. **Procedure III - Drip:** The drip test has a requirement for a volume of water greater than 280 L/m²/hr (7 gal/ft²/hr) dripping through a pre-determined hole pattern. An alternative requirement is for items exposed only to 140 L/m²/hr (3.5 gal/ ft²/hr): Appropriately reduce the drip rate as long as the duration of the test is extended to 30 minutes to ensure the equivalent volume of water falls on the test item.

2.3.3 Droplet Size.

Nominal drop-size spectra exist for instantaneous rainfall rates but for the long-term rainfall rates they are meaningless since rates are made up of many different instantaneous rates possessing different spectra (paragraph 6.1, reference a). For Procedures I and II, use droplet sizes predominantly in the range of approximately 500 μm in diameter^{1/} (that is considered to be mist or drizzle rather than rain (paragraph 6.1, reference b), to 4500 μm in diameter (paragraph 6.1, reference c). For lower rain rates, it may be difficult to achieve specified droplet size. For drip tests using dispensing tubes (Figure 506.6-1), polyethylene tubing sleeves added to the dispensing tubes will increase the droplet size to its maximum. Procedure III is not meant to simulate rain but rather droplets of condensation or overhead leakage, and therefore droplets may be larger than 4500 μm in diameter. Since the drip test is not to simulate rain, the droplets do not need to reach terminal velocity. It is possible to achieve larger droplet sizes, since the air resistance may not be sufficient to cause them to break up. The largest drop size that can be achieved without coalescence is recommended.

NOTE: Observations have shown that water droplets introduced into a high velocity air stream tend to break up over distance (paragraph 6.1, references d and e). Accordingly, recommend introducing the droplets as close as possible to the test item while assuring the droplets achieve the required velocity prior to impact with the test item.

2.3.4 Wind Velocity.

High rainfall intensities accompanied by winds of 18 m/s (40 mph) are not uncommon during storms. Unless otherwise specified or when steady state conditions are specified, recommend this velocity. Where facility limitations preclude the use of wind, use Procedure II.

NOTE: Without straightening vanes, fans may not produce the required wind velocity near the center of the wind stream.

^{1/}Observations show there are no drops of less than roughly 500 μm diameter during intense rains (paragraph 6.1, reference b).

MIL-STD-810H
METHOD 506.6**2.3.5 Test Item Exposure Surface (Orientation).**

Wind-blown rain will usually have more of an effect on vertical surfaces than on horizontal surfaces, and vice versa for vertical or near-vertical rain. Expose all surfaces onto which the rain could fall or be driven to the test conditions. Rotate the item as required to expose all vulnerable surfaces.

2.3.6 Water Pressure.

Procedure II relies on pressurized water. Vary the pressure as necessary to comply with the requirements documents, but a minimum value of 276 kPa (40 psig) nozzle pressure is given as a guideline based on past experience. This value will produce water droplets traveling at approximately 64 km/h (40 mph) when using a nozzle as specified in paragraph 4.1.2.

2.3.7 Preheat Temperature.

Experience has shown that a temperature differential between the test item and the rainwater can affect the results of a rain test. When specified for nominally sealed items, increasing the test item temperature to about 10 °C (18 °F) higher than the rain temperature at the beginning of each exposure period to subsequently produce a negative pressure inside the test item will provide a more reliable verification of its watertightness. Ensure the heating time is the minimum required to stabilize the test item temperature, and not sufficient to dry the test item when not opened between exposures.

2.3.8 Exposure Duration.

Determine the exposure duration from the life cycle profile, but do not use a duration less than that specified in the individual procedures. For items made of material that may absorb moisture, the duration may have to be significantly extended to reflect real life cycle circumstances and, for drip tests, the drip rate appropriately reduced. With certain materials, the water penetration and thus the degradation is more a function of time (length of exposure) than the volume or rain/drip rate exposure.

3. INFORMATION REQUIRED.**3.1 Pretest.**

The following information is required to conduct rain tests adequately.

- a. General. Information listed in Part One, paragraphs 5.7 and 5.9, and Annex A, Task 405 of this Standard.
- b. Specific to this Method.
 - (1) Rainfall rate.
 - (2) Exposure surfaces/duration.
 - (3) Test item preheat temperature.
 - (4) Initial water temperature.
 - (5) Wind velocity.
 - (6) Water pressure (if appropriate).
 - (7) Photographs as appropriate.
 - (8) Test item weight, if required. This may be useful for detecting moisture intrusion in small test items where an internal visual inspection may not be feasible. In large test items, the precision of the scale limits ability to detect small amounts of water intrusion, so weighing of large items is not typically performed.
- c. Tailoring. Necessary variations in the basic test procedures to accommodate environments identified in the LCEP.

3.2 During Test.

Collect the following information during conduct of the test:

MIL-STD-810H
METHOD 506.6

- a. General. Information listed in Part One, paragraph 5.10, and in Annex A, Tasks 405 and 406 of this Standard.
- b. Specific to this Method. For test validation purposes, record deviations from planned or pre-test procedures or parameter levels, including any procedural anomalies that may occur.

3.3 Post-Test.

The following post test data shall be included in the test report.

- a. General. Information listed in Part One, paragraph 5.13, and in Annex A, Task 406 of this Standard.
- b. Specific to this Method.
 - (1) Surfaces of the test item subjected to rainfall.
 - (2) Duration of exposure per face.
 - (3) Results of inspection for water penetration (amount and probable point of entry).
 - (4) Results of operational checks.
 - (5) Length of time for each performance check.
 - (6) Any modifications from the test plan.
 - (7) Photographs as appropriate.
 - (8) If required, test item weights prior to and following exposures.

4. TEST PROCESS.**4.1 Test Facility.****4.1.1 Procedure I - Rain and Blowing Rain.**

- a. Use a rain facility capable of producing falling rain at the rate specified herein. To produce the rain, use a water distribution device that produces droplets having a diameter range predominantly between 500 μm and 4500 μm . Ensure the rain is dispersed completely over the test item when accompanied by the prescribed wind. A water-soluble dye such as fluorescein may be added to the rainwater to aid in locating and analyzing water leaks. For steady state rain, use either spray nozzles or the apparatus shown in Figure 506.6-1 (with the polyethylene tubing removed), and position the dispenser at a height sufficient to ensure the drops approach terminal velocity (about 9 m/s (29.5 ft/sec.)). It is not necessary to use de-ionized or distilled water for this test. Do not allow rust or corrosive contaminants from the facility infrastructure to impact the test item.
- b. Position the wind source with respect to the test item so that it will cause the rain to beat directly, with variations up to 45° from the horizontal, and uniformly against one side of the test item. Use a wind source that can produce horizontal wind velocities equal to and exceeding 18 m/s (59.1 ft/sec.). Measure the wind velocity at the position of the test item before placement of the test item in the facility.

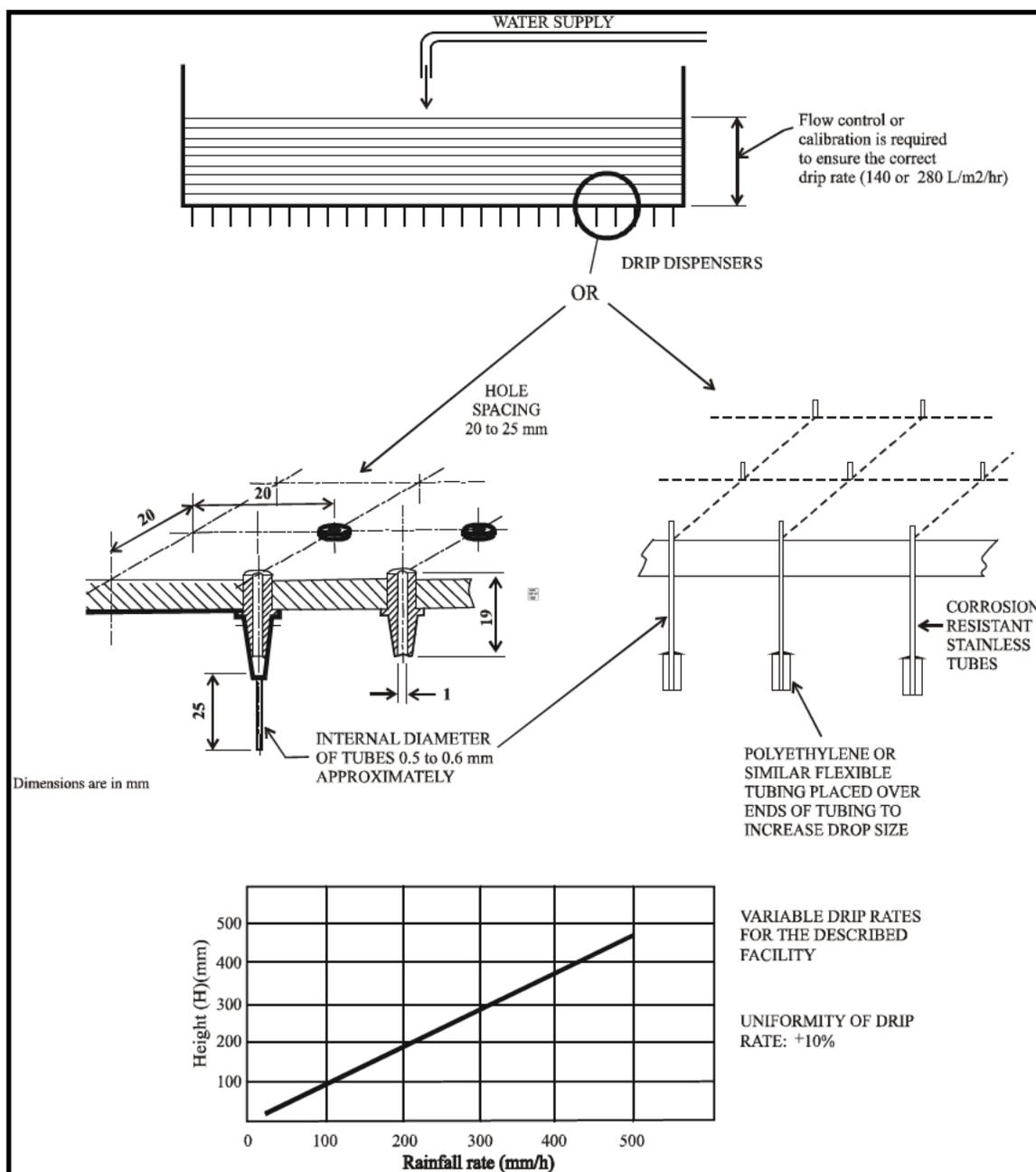
MIL-STD-810H
METHOD 506.6

Figure 506.6-1. Sample facility for steady state rain or drip test.

4.1.2 Procedure II - Exaggerated.

Use nozzles that produce a square spray pattern or other overlapping pattern (for maximum surface coverage) and with a droplet size predominantly in the 500 to 4500 μm range at approximately 276 kPa (40 psig). Use at least one nozzle for each 0.56 m² (6 ft²) of surface area and position each about 48 cm (19 in.) from the test surface. Adjust this distance as necessary to achieve overlap of the spray patterns. A water-soluble dye such as fluorescein added to the rainwater may aid in locating and analyzing any water leaks. For Procedure II, position the nozzles as required by the test plan or as depicted on Figure 506.6-2. Although Figure 506.6-2 shows an S-280 shelter, the nozzle configuration is typical for larger test items. In general, ensure the sides and top of the test item are subjected to overlapping water spray patterns.

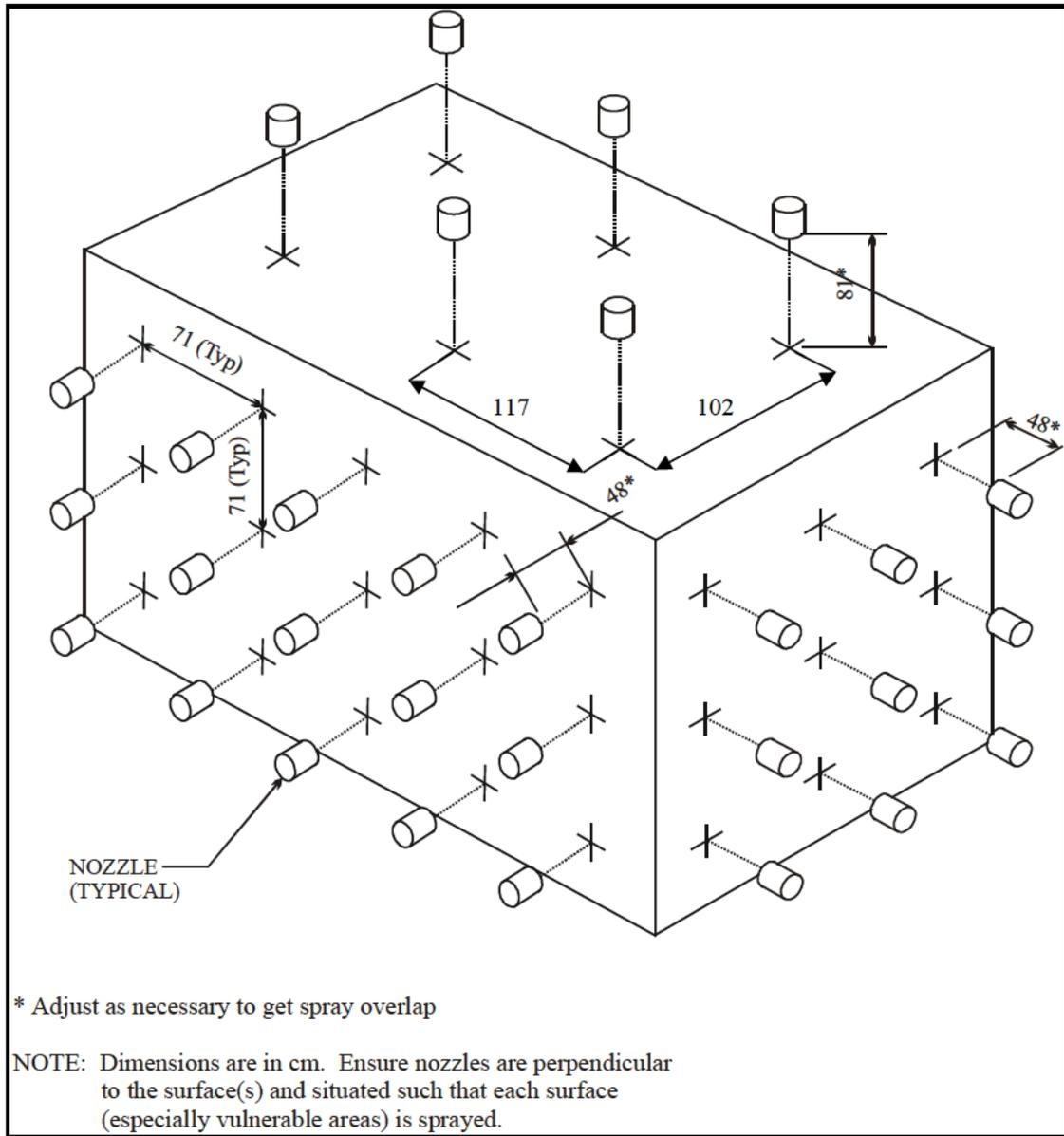
MIL-STD-810H
METHOD 506.6

Figure 506.6-2. Typical nozzle setup for exaggerated test, Procedure II (not intended for use when conducting Procedure I testing).

4.1.3 Procedure III - Drip.

Use a test setup that provides a volume of water greater than $280 \text{ l/m}^2/\text{hr}$ ($7 \text{ gal/ft}^2/\text{hr}$) dripping from a dispenser with drip holes on a 20 to 25.4 mm (0.79 – 1.0 inch) pattern (depending on which dispenser is used) but without coalescence of the drips into a stream. Figures 506.6-1 and 506.4-3 provide possible dispenser designs. Either arrangement shown on Figure 506.6-1 is recommended over that of Figure 506.6-3 due to its simplicity of construction, maintenance, cost, and reproducibility of tests. The polyethylene tubing is optional, but it ensures maximum droplet size. Use a drip height from a specified height (no less than 1 meter (3 feet)) as measured from the upper main surface of the test item. Use a dispenser with a drip area large enough to cover the entire top surface of the test item. For known conditions where a $280 \text{ L/m}^2/\text{hr}$ ($7 \text{ gal/ft}^2/\text{hr}$) drip rate cannot occur, test the item by reducing the drip rate and increasing the test duration. For example, for an item exposed only to $140 \text{ L/m}^2/\text{hr}$ ($3.5 \text{ gal/ft}^2/\text{hr}$), appropriately reduce the drip rate as long as the duration of the test is extended to 30 minutes to ensure the equivalent volume of water falls on the test item. A water-soluble dye such as fluorescein added to the rainwater may aid in locating and analyzing water leaks. Recommend the water be filtered using a fine sediment filter to ensure particulate buildup does not block the tubing.

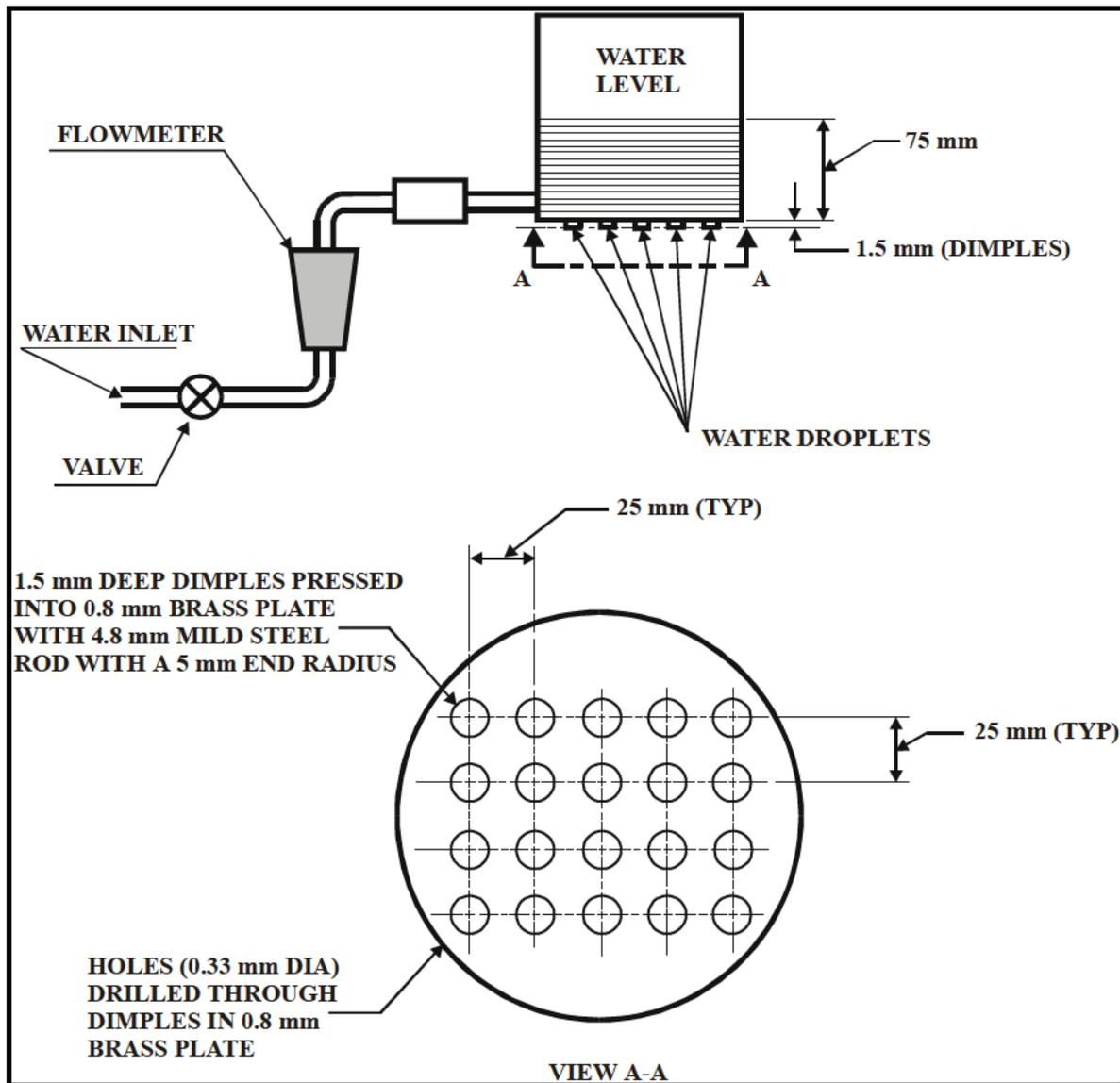
MIL-STD-810H
METHOD 506.6

Figure 506.6-3. Details of dispenser for drip test, Procedure III.

4.2 Controls.

- For Procedures I and II, verify the rainfall rate immediately before each test.
- For Procedure I, verify the wind velocity immediately before each test.
- For Procedures I and II, verify the nozzle spray pattern and pressure before each test.
- For Procedure III, verify the flow rate immediately before and after the test to ensure test tolerances are met throughout the test, and ensure that only separate (or discrete) drops are issuing from the dispensers.
- Unless otherwise specified, water used for rain tests can be from local water supply sources.
- Record test parameters at a sufficient rate to capture data necessary for post-test analysis (see Part One, paragraph 5.18).

MIL-STD-810H
METHOD 506.6

4.3 Test Interruption.

Test interruptions can result from two or more situations, one being from failure or malfunction of test chambers or associated test laboratory equipment. The second type of test interruption results from failure or malfunction of the test item itself during required or optional performance checks.

4.3.1 Interruption Due to Chamber Malfunction.

- a. General. See Part One, paragraph 5.11 of this Standard.
- b. Specific to this Method. Interruption of a rain test is unlikely to generate any adverse effects. Normally, continue the test from the point of interruption.

4.3.2 Interruption Due to Test Item Operation Failure.

Failure of the test item(s) to function as required during mandatory or optional performance checks during testing presents a situation with several possible options.

- a. The preferable option is to replace the test item with a “new” one and restart from Step 1.
- b. A second option is to replace / repair the failed or non-functioning component or assembly with one that functions as intended, and restart the entire test from Step 1.

NOTE: When evaluating failure interruptions, consider prior testing on the same test item and consequences of such.

4.4 Test Execution.

The following steps, alone or in combination, provide the basis for collecting necessary information concerning the materiel's watertightness.

4.4.1 Preparation for Test.

4.4.1.1 Preliminary Steps.

Before starting the test, review pretest information in the test plan to determine test details (e.g., procedures, test item configuration/orientation, cycles, durations, parameter levels for storage/operation, rainfall rates and wind velocities (for Procedure I), etc.). (See paragraph 3.1, above.)

4.4.1.2 Pretest Standard Ambient Checkout.

All test items require a pretest standard ambient checkout to provide baseline data. Conduct the checkout as follows:

- Step 1. Stabilize the test item at standard ambient conditions (Part One, paragraph 5.1), in the test chamber whenever possible.
- Step 2. Conduct a complete pretest examination and document the results.
- Step 3. Prepare the test item in accordance with Part One, paragraph 5.8 and in the required test item configuration.
- Step 4. To establish baseline data, conduct an operational checkout in accordance with the test plan, and record the results. If required to support detection of water intrusion, weigh the test item.
- Step 5. If the test item operates satisfactorily, proceed to paragraph 4.4.2, 4.4.3, or 4.4.4 as appropriate. If not, resolve the problems and repeat Steps 3 and 4 above.

4.4.2 Procedure I - Rain and Blowing Rain.

- Step 1. Heat the test item or cool the water so that the stabilized test item temperature is a minimum of 10 °C (18 °F) above the rain water temperature at the start of each exposure period (see paragraph 2.3.7).
- Step 2. Install the test item in the facility in the configuration defined in the test plan.

MIL-STD-810H
METHOD 506.6

- Step 3. Initiate the wind speed and rain rate specified in the test plan and maintain these conditions for a minimum of 30 minutes. If required, operate the test item for the last 10 minutes of the 30-minute rain exposure. If the test item fails to operate as intended, follow the guidance in paragraph 4.3.2 for test item failure.
- Step 4. Examine the test item in the test chamber (if possible), otherwise, remove the test item from the test facility and conduct a visual inspection.
- Step 5. Measure and document any free water found inside the protected areas of the test item. If required, weigh the test item.
- Step 6. Repeat Steps 1 through 5 until all exposure surfaces of concern have been tested.
- Step 7. Operate the test item for compliance with the requirements document, and document the results. See paragraph 5 for analysis of results. If water has penetrated the test item, judgment must be used before operation of the test item. It may be necessary to empty water from the test item (and measure the quantity) to prevent a safety hazard.

4.4.3 Procedure II - Exaggerated.

- Step 1. Install the test item (with all doors, louvers, etc., closed) in the test facility.
- Step 2. Position the nozzles as required by the test plan or as indicated in Figure 506.6-2.
- Step 3. Spray all exposed surfaces of the test item with water for not less than 40 minutes per face.
- Step 4. After each 40-minute spray period, inspect the interior of the test item for evidence of free water. Estimate its volume and the probable point of entry and document. If required, weigh the test item.
- Step 5. Conduct an operational check of the test item as specified in the test plan, and document the results. See paragraph 5 for analysis of results.

4.4.4 Procedure III - Drip.

- Step 1. Install the test item in the facility in accordance with Part One, paragraph 5.8 and in its operational configuration with all connectors and fittings engaged. Ensure the temperature differential between the test item and the water is 10 °C (18 °F) or greater. If necessary, either raise the test item temperature or lower the water temperature to achieve the differential in paragraph 2.3.7, and restore the test item to its normal operating configuration immediately before testing.
- Step 2. Verify the proper water flow rate and ensure that only separate (or discrete) drops are issuing from the dispensers.
- Step 3. With the test item operating, subject it to water falling from a specified height (no less than 1 meter (3 feet)) as measured from the upper main surface of the test item at a uniform rate for 15 minutes or as otherwise specified (see Figure 506.6-1 or Figure 506.6-3). Use a test setup that ensures that all of the upper surfaces get droplets on them at some time during the test. For test items with glass-covered instruments, tilt them at a 45° angle, dial up. If the test item fails to operate as intended, follow the guidance in paragraph 4.3.2 for test item failure.
- Step 4. At the conclusion of the 15-minute exposure, remove the test item from the test facility and remove sufficient panels or covers to allow the interior to be seen. Verify the proper water flow rate.
- Step 5. Visually inspect the test item for evidence of water penetration.
- Step 6. Measure and document any free water inside the test item. If required, weigh the test item.
- Step 7. Conduct an operational check of the test item as specified in the test plan, and document the results. See paragraph 5 for analysis of results.

5. ANALYSIS OF RESULTS.

In addition to the guidance provided in Part One, paragraphs 5.14 and 5.17, the following information is provided to assist in the evaluation of the test results. Analyze any failure of a test item to meet the requirements of the materiel specifications and consider related information such as follows.

MIL-STD-810H
METHOD 506.6

5.1 Operational Failures.

- a. Degradation allowed in the performance characteristics because of rainfall exposure.
- b. Necessity for special kits for special operating procedures.
- c. Safety of operation.

5.2 Water Penetration.

Based on the individual materiel and the requirements for its non-exposure to water, determine if one of the following is applicable:

- a. Unconditional failure. Any evidence of water penetration into the test item enclosure following the rain test.
- b. Acceptable water penetration. Water penetration of not more than 4 cm³ per 28,000 cm³ (1 ft³) of test item enclosure provided the following conditions are met:
 - (1) There is no immediate effect of the water on the operation of the materiel.
 - (2) The test item in its operational configuration (transit/storage case open or removed) can successfully complete the aggravated temperature/humidity procedure of Method 507.

6. REFERENCE/RELATED DOCUMENTS.

6.1 Referenced Documents.

- a. MIL-HDBK-310, Global Climatic Data for Developing Military Products.
- b. Huschke, R. E. (ed.), Glossary of Meteorology. Boston: American Meteorological Society, 1970; Air Force Institute of Technology.
- c. Rogers, R.R., Short Course in Cloud Physics, Oxford; Boston: Butterworth-Heinemann, 1989; Air Force Institute of Technology.
- d. AMR-PS-08-01, Kinetic Energy Interceptor Flight Weather Encounter Requirements Development, November 2007.

6.2 Related Documents.

- a. NATO STANAG 4370, Allied Environmental Conditions and Test Publication (AECTP) 230, Climatic Conditions and AECTP 300, Climatic Environmental Testing.
- b. AR 70-38, Research, Development, Test and Evaluation of Materiel for Extreme Climatic Conditions.
- c. Egbert, Herbert W. "The History and Rationale of MIL-STD-810 (Edition 2)," January 2010; Institute of Environmental Sciences and Technology, Arlington Place One, 2340 S. Arlington Heights Road, Suite 100, Arlington Heights, IL 60005-4516.
- d. Army Materiel Command Pamphlet AMCP-706-116, Engineering Design Handbook, Environmental Factors
- e. RTCA/DO-160D, Environmental Conditions and Test Procedures for Airborne Equipment
- f. Tattelman, P.I., and Sissenwine, N., Extremes of Hydrometers at Altitude for MIL-STD-210B: Supplement Drop Size Distributions (1973), AFCRL-TR-73-0008, AFSG 253
- g. R.M. Clayton et al, Rain Simulation for High-Intensity Acoustic Noise Cavities. Jet Propulsion Laboratory, California Institute of Technology, Pasadena, CA, Report NPO-17237/6745.
- h. Synopsis of Background Material for MIL-STD-210B, Climatic Extremes for Military Equipment. Bedford, MA: Air Force Cambridge Research Laboratories, 24 January 1974, DTIC number AD-780-508.

(Copies of Department of Defense Specifications, Standards, and Handbooks, and International Standardization Agreements are available online at <https://assist.dla.mil>.)

MIL-STD-810H
METHOD 506.6

Requests for other defense-related technical publications may be directed to the Defense Technical Information Center (DTIC), ATTN: DTIC-BR, Suite 0944, 8725 John J. Kingman Road, Fort Belvoir VA 22060-6218, 1-800-225-3842 (Assistance--selection 3, option 2), <http://www.dtic.mil/dtic/>; and the National Technical Information Service (NTIS), Springfield VA 22161, 1-800-553-NTIS (6847), <http://www.ntis.gov/>.

MIL-STD-810H
METHOD 506.6

(This page is intentionally blank.)

MIL-STD-810H
METHOD 507.6

METHOD 507.6

HUMIDITY

CONTENTS

1.	SCOPE	1
1.1	PURPOSE	1
1.2	APPLICATION	1
1.3	LIMITATIONS.....	1
2.	TAILORING GUIDANCE	1
2.1	SELECTING THE HUMIDITY METHOD	1
2.1.1	EFFECTS OF WARM, HUMID ENVIRONMENTS	2
2.1.2	SEQUENCE AMONG OTHER METHODS.....	2
2.2	SELECTING PROCEDURES	2
2.2.1	PROCEDURE SELECTION CONSIDERATIONS	3
2.2.2	DIFFERENCE BETWEEN PROCEDURES	3
2.3	DETERMINE TEST LEVELS, CONDITIONS, AND DURATIONS.....	3
2.3.1	TEST TEMPERATURE - HUMIDITY.....	3
2.3.2	TEST DURATION.....	5
2.3.3	TEST ITEM CONFIGURATION	7
2.3.4	ADDITIONAL GUIDELINES	7
2.4	OPERATIONAL CHECKOUT	7
2.4.1	PROCEDURE I (INDUCED CYCLES B1, B2, OR B3, FOLLOWED BY NATURAL CYCLES B1, B2, OR B3)	7
2.4.2	PROCEDURE II - AGGRAVATED	7
2.5	TEST VARIATIONS.....	7
2.6	PHILOSOPHY OF TESTING	7
2.6.1	PROCEDURE I - INDUCED (STORAGE AND TRANSIT) CYCLES	8
2.6.2	PROCEDURE I - NATURAL CYCLES	10
2.6.3	PROCEDURE II - AGGRAVATED CYCLE (FIGURE 507.6-7)	13
3.	INFORMATION REQUIRED.....	14
3.1	PRETEST	14
3.2	DURING TEST	15
3.3	POST-TEST	15
4.	TEST PROCESS	15
4.1	TEST FACILITY	15
4.1.1	GENERAL DESCRIPTION	15
4.1.2	FACILITY DESIGN.....	15
4.1.3	TEST SENSORS AND MEASUREMENTS	15
4.1.4	AIR VELOCITY	16
4.1.5	HUMIDITY GENERATION	16
4.1.6	CONTAMINATION PREVENTION	16
4.2	CONTROLS	16
4.3	TEST INTERRUPTION	16
4.3.1	INTERRUPTION DUE TO CHAMBER MALFUNCTION.....	16
4.3.2	INTERRUPTION DUE TO TEST ITEM OPERATION FAILURE.....	17
4.4	TEST EXECUTION	17
4.4.1	PREPARATION FOR TEST.....	17
4.4.1.1	TEST SETUP.....	17
4.4.1.2	PRELIMINARY STEPS	17

MIL-STD-810H
METHOD 507.6

CONTENTS - Continued

<u>Paragraph</u>	<u>Page</u>
4.4.1.3 PRETEST CHECKOUT	17
4.4.2 TEST PROCEDURES.....	17
4.4.2.1 PROCEDURE I - STORAGE AND TRANSIT CYCLES (CYCLES B2 OR B3), AND NATURAL (CYCLES B1, B2, OR B3).....	17
4.4.2.2 PROCEDURE II - AGGRAVATED	18
5. ANALYSIS OF RESULTS	19
6. REFERENCE/RELATED DOCUMENTS	19
6.1 REFERENCED DOCUMENTS.....	19
6.2 RELATED DOCUMENTS.....	19

TABLES

TABLE 507.6-I HIGH HUMIDITY DIURNAL CATEGORIES	5
TABLE 507.6-II TEST CYCLES (DAYS)	7
TABLE 507.6-III CONSTANT TEMPERATURE AND HUMIDITY - INDUCED CYCLE B1	8
TABLE 507.6-IV CYCLIC HIGH RELATIVE HUMIDITY - INDUCED CYCLE B2	9
TABLE 507.6-V HOT HUMID - INDUCED CYCLE B3.....	10
TABLE 507.6-VI CONSTANT TEMPERATURE AND HUMIDITY - NATURAL CYCLE B1	11
TABLE 507.6-VII CYCLIC HIGH RELATIVE HUMIDITY - NATURAL CYCLE B2	12
TABLE 507.6-VIII HOT HUMID - NATURAL CYCLE B3.....	13
TABLE 507.6-IX AGGRAVATED CYCLE	14

FIGURES

FIGURE 507.6-1 INDUCED CYCLE B1 - STORAGE AND TRANSIT.....	8
FIGURE 507.6-2 INDUCED CYCLE B2 - STORAGE AND TRANSIT.....	9
FIGURE 507.6-3 INDUCED CYCLE B3 - STORAGE AND TRANSIT.....	10
FIGURE 507.6-4 NATURAL CYCLE B1 - CONSTANT HIGH HUMIDITY.....	11
FIGURE 507.6-5 NATURAL CYCLE B2 - CYCLIC HIGH HUMIDITY	12
FIGURE 507.6-6 NATURAL CYCLE B3 - HOT HUMID.....	13
FIGURE 507.6-7 AGGRAVATED TEMPERATURE - HUMIDITY CYCLE	14

**METHOD 507.6, ANNEX A
PHYSICAL PHENOMENA ASSOCIATED WITH HUMIDITY**

1. ABSORPTION	A-1
2. ADSORPTION	A-1
3. BREATHING	A-1
4. CONDENSATION	A-1
5. DIFFUSION.....	A-1

MIL-STD-810H
METHOD 507.6**METHOD 507.6****HUMIDITY**

NOTE: Tailoring is essential. Select methods, procedures, and parameter levels based on the tailoring process described in Part One, paragraph 4.2.2, and Annex C. Apply the general guidelines for laboratory test methods described in Part One, paragraph 5 of this Standard.

1. SCOPE.**1.1 Purpose.**

The purpose of this Method is to determine the resistance of materiel to the effects of a warm, humid atmosphere.

1.2 Application.

This Method applies to materiel that is likely to be stored or deployed in a warm, humid environment, an environment in which high levels of humidity occur, or to provide an indication of potential problems associated with humidity. Although it is preferable to test materiel at appropriate natural environment sites, it is not always practical because of logistical, cost, or schedule considerations. Warm, humid conditions can occur year-round in tropical areas, seasonally in mid-latitude areas, and in materiel subjected to combinations of changes in pressure, temperature, and relative humidity. Often materiel enclosed in non-operating vehicles in warm, humid areas can experience high internal temperature and humidity conditions. Other high levels of humidity can exist worldwide. Further information on high temperatures and humidity is provided in AR 70-38 (paragraph 6.1, reference a), MIL-HDBK-310 (paragraph 6.1, reference b), or NATO STANAG 4370, AECTP 230 (paragraph 6.1, reference c). See also Part Three of this Standard.

1.3 Limitations.

This Method may not reproduce all of the humidity effects associated with the natural environment such as long-term effects, nor with low humidity situations. This Method does not attempt to duplicate the complex temperature/humidity environment but, rather, it provides a generally stressful situation that is intended to reveal potential problem areas in materiel. This Method includes natural and induced temperature/humidity cycles (for guidance purposes) for identified climatic categories, but these cycles cannot replicate naturally-occurring environments. Testing in the natural environment, whenever practical, may provide more valuable results. Specifically, this Method does not address:

- a. Condensation resulting from changes of pressure and temperature for airborne or ground materiel.
- b. Condensation resulting from black-body radiation (e.g., night sky effects).
- c. Synergistic effects of solar radiation, humidity, or condensation combined with biological and chemical contaminants.
- d. Liquid water trapped within materiel or packages and retained for significant periods.
- e. Evaluating the internal elements of a hermetically sealed assembly since such materiel is air-tight.

2. TAILORING GUIDANCE.**2.1 Selecting the Humidity Method.**

After examining requirements documents and applying the tailoring process in Part One of this Standard to determine if warm temperature/humidity conditions are anticipated in the life cycle of materiel, use the following to confirm the need for this Method and to place it in sequence with other methods.

NOTE: Consider the potential synergistic effects of temperature, humidity, and altitude, and the use of Method 520.5 in addition to this Method. However, Method 520 is NOT a substitute for Method 507.

MIL-STD-810H
METHOD 507.6**2.1.1 Effects of Warm, Humid Environments.**

Temperature-humidity conditions have physical and chemical effects on materiel; the temperature and humidity variations can also trigger synergistic effects or condensation inside materiel. Consider the following typical problems to help determine if this Method is appropriate for the materiel being tested. This list is not intended to be all-inclusive.

- a. Surface effects, such as:
 - (1) Oxidation and/or galvanic corrosion of metals.
 - (2) Increased chemical reactions.
 - (3) Chemical or electrochemical breakdown of organic and inorganic surface coatings.
 - (4) Interaction of surface moisture with deposits from external sources to produce a corrosive film.
 - (5) Changes in friction coefficients, resulting in binding or sticking.
- b. Changes in material properties, such as:
 - (1) Swelling of materials due to sorption effects.
 - (2) Other changes in properties.
 - (a) Loss of physical strength.
 - (b) Electrical and thermal insulating characteristics.
 - (c) De-lamination of composite materials.
 - (d) Change in elasticity or plasticity.
 - (e) Degradation of hygroscopic materials.
 - (f) Degradation of explosives and propellants by absorption.
 - (g) Degradation of optical element image transmission quality.
 - (h) Degradation of lubricants.
- c. Condensation and free water, such as:
 - (1) Electrical short circuits.
 - (2) Fogging of optical surfaces.
 - (3) Changes in thermal transfer characteristics.

2.1.2 Sequence Among Other Methods.

- a. General. Use the anticipated life cycle sequence of events as a general sequence guide (see Part One, paragraph 5.5).
- b. Unique to this Method. Humidity testing may produce irreversible effects. If these effects could unrealistically influence the results of subsequent tests on the same item(s), perform humidity testing following those tests. Also, because of the potentially unrepresentative combination of environmental effects, it is generally inappropriate to conduct this test on the same test sample that has previously been subjected to salt fog, sand and dust, or fungus tests. Dynamic environments (vibration and shock) could influence the results of humidity testing. Consider performing these dynamic tests prior to humidity tests.

2.2 Selecting Procedures

This Method consists of two procedures, Procedure I (Induced (Storage and Transit) and Natural Cycles), and Procedure II (Aggravated). Determine the procedure(s) to be used.

NOTE: The materiel's anticipated Life Cycle Environmental Profile (LCEP) may reveal other scenarios that are not specifically addressed in the procedures. Tailor the procedures as necessary to capture the LCEP variations, but do not reduce the basic test requirements reflected in the below procedures. (See paragraph 2.3 below.)

MIL-STD-810H
METHOD 507.6**2.2.1 Procedure Selection Considerations.**

- a. The operational purpose of the materiel.
- b. The natural exposure circumstances.
- c. Test data required to determine if the operational purpose of the materiel has been met.
- d. Test duration.

2.2.2 Difference Between Procedures. (See paragraph 1.3c for related information on limitations.)

- a. Procedure I – Induced (Storage and Transit) and Natural Cycles. Once a cycle is selected, perform the storage and transit portion first, followed by the corresponding natural environment portion of the cycle. Procedure I includes:
 - (1) three unique cycles that represent conditions that may occur during storage or transit, as well as
 - (2) three unique natural environment cycles that are performed on test items that are open to the environment.

NOTE: Although combined under one major column in Table 507.6-I, storage configurations (and any packaging) may differ from configurations for the transit mode (see paragraph 2.3.3). Ensure the configuration used for testing is appropriate for the intended portion of the LCEP. Items in storage or transit could also experience relatively constant conditions if situated near heat-producing equipment, or are sufficiently insulated from external cycling conditions. For the purpose of this test, a “sealed” item is one that could have a relatively high internal level of humidity and lacks continuous or frequent ventilation. It does not include hermetically sealed items.

The internal humidity may be caused by these or other mechanisms:

- (a) Entrapped, highly humid air.
 - (b) Presence of free water.
 - (c) Penetration of moisture through test item seals (breathing).
 - (d) Release of water or water vapor from hygroscopic material within the test item.
- b. Procedure II – Aggravated. Procedure II exposes the test item to more extreme temperature and humidity levels than those found in nature (without contributing degrading elements), but for shorter durations. Its advantage is that it produces results quickly, i.e., it may, generally, exhibit temperature-humidity effects sooner than in the natural or induced procedures. Its disadvantage is that the effects may not accurately represent those that will be encountered in actual service. Be careful when interpreting results. This procedure is used to identify potential problem areas, and the test levels are fixed.

2.3 Determine Test Levels, Conditions, and Durations.

Related test conditions depend on the climate, duration, and test item configuration during shipping, storage, and deployment. The variables common to both procedures are the temperature-humidity cycles, duration, and configuration. These variables are discussed below. Requirements documents may impose or imply additional test conditions. Otherwise, use the worst-case conditions to form the basis for selecting the test and test conditions to use.

2.3.1 Test Temperature - Humidity.

The specific test temperature - humidity values are selected, preferably, from the requirements documents. If this information is not available, base determination of the test temperature-humidity values for Procedure I on the world geographical areas in which the test item will be used, plus any additional considerations. Table 507.6-I was developed from AR 70-38 (paragraph 6.1, reference a), MIL-HDBK-310 (paragraph 6.1, reference b), NATO STANAG 4370 (paragraph 6.1, reference d), AECTP 200 (paragraph 6.1, reference e), and NATO STANAG 4370, AECTP 230 (paragraph 6.1, reference c, (part three)) and includes the temperature and relative humidity conditions for three geographical categories where high relative humidity conditions may be of concern, and three related categories of induced conditions. The temperature and humidity data are those used in the source documents

MIL-STD-810H
METHOD 507.6

mentioned above. The cycles were derived from available data; other geographic areas could be more severe. For Procedure I, the temperature and humidity levels in Table 507.6-I are representative of specific climatic areas; the natural cycles are not adjustable. Figures 507.6-1 through 507.6-6 are visual representations of the cycles in Table 507.6-I.

Although they occur briefly or seasonally in the mid-latitudes, basic high humidity conditions are found most often in tropical areas. One of the two high humidity cycles (constant high humidity) represents conditions in the heavily forested areas where nearly constant conditions may prevail during rainy and wet seasons. Exposed materiel is likely to be constantly wet or damp for many days at a time. A description of each category follows.

- a. Constant high humidity (Cycle B1). Constant high humidity is found most often in tropical areas, although it occurs briefly or seasonally in the mid-latitudes. The constant-high-humidity cycle represents conditions in heavily forested areas where nearly constant temperature and humidity may prevail during rainy and wet seasons with little (if any) solar radiation exposure. Tropical exposure in a tactical configuration or mode is likely to occur under a jungle canopy. Exposed materiel is likely to be constantly wet or damp for many days at a time. World areas where these conditions occur are the Congo and Amazon Basins, the jungles of Central America, Southeast Asia (including the East Indies), the north and east coasts of Australia, the east coast of Madagascar, and the Caribbean Islands. The conditions can exist for 25 to 30 days each month in the most humid areas of the tropics. The most significant variation of this cycle is its frequency of occurrence. In many equatorial areas, it occurs monthly, year round, although many equatorial areas experience a distinctive dry season. The frequency decreases as the distance from the equator increases. The mid-latitudes can experience these conditions several days a month for two to three months a year. See Part Three for further information on the description of the environments.
- b. Cyclic high humidity (Cycle B2). Cyclic high humidity conditions are found in the open in tropical areas where solar radiation is a factor. If the item in its operational configuration is subject to direct solar radiation exposure, it is permissible to conduct the natural cycle with simulated solar radiation. See Part Three, Table VII, for the associated B2 diurnal solar radiation parameters. In these areas, exposed items are subject to alternate wetting and drying, but the frequency and duration of occurrence are essentially the same as in the constant high humidity areas. Cycle B2 conditions occur in the same geographical areas as the Cycle B1 conditions, but the B1 conditions typically are encountered under a jungle canopy, so the B1 description above also applies to the B2 area.
- c. Hot-humid (Cycle B3). Severe (high) dewpoint conditions occur 10 to 15 times a year along a very narrow coastal strip, probably less than 5 miles wide, bordering bodies of water with high surface temperatures, specifically the Persian Gulf and the Red Sea. If the item in its operational configuration is subject to direct solar radiation exposure, it is permissible to conduct the natural cycle with simulated solar radiation. See Part Three, Table V for the associated B3 diurnal solar radiation parameters. Most of the year, these same areas experience hot dry (A1) conditions. This cycle is unique to materiel to be deployed specifically in the Persian Gulf or Red Sea regions, and is not to be used as a substitute for worldwide exposure requirements where B1 or B2 would apply.

In addition to these three categories of natural high-humidity conditions, there are three cycles for induced (storage and transit) conditions:

- d. Induced constant high humidity (Cycle B1). Relative humidity above 95 percent in association with nearly constant 27 °C (80 °F) temperature occurs for periods of a day or more.
- e. Induced variable - high humidity (Cycle B2). This condition exists when materiel in the variable-high-humidity category receives heat from solar radiation with little or no cooling air. See storage and transit conditions associated with the hot-humid daily cycle of the hot climatic design type below in Table 507.6-I.
- f. Induced hot-humid (Cycle B3). This condition exists when materiel in the hot-humid category receives heat from solar radiation with little or no cooling air. The daily cycle for storage and transit in Table 507.6-I shows 5 continuous hours with air temperatures at or above 66 °C (150 °F), and an extreme air temperature of 71 °C (160 °F) for not more than 1 hour.

MIL-STD-810H
METHOD 507.6**Table 507.6-I. High humidity diurnal categories.**

Time	Natural ¹									Induced (Storage and Transit)												
	High Humidity						Hot Humid (Cycle B3)			Constant Temp. (Cycle B1)			Cyclic High RH (Cycle B2)			Hot Humid (Cycle B3)						
	Constant Temp. (Cycle B1)		Cyclic High RH (Cycle B2)																			
	Temp		RH		Temp		RH		Temp		RH		Temp		RH							
°C	°F	%	°C	°F	%	°C	°F	%	°C	°F	%	°C	°F	%	°C	°F	%					
0100	Nearly constant at 24°C (75°F) throughout the 24 hours						100 ²	27	80	100	31	88	88	Nearly constant at 27°C (80°F) throughout the 24 hours								
0200							100	26	79	100	31	88	88									
0300							100	26	79	100	31	88	88									
0400							100	26	79	100	31	88	88									
0500							100	26	78	100	31	88	88									
0600							100	29	78	100	32	90	85									
0700							98	27	81	94	34	93	80									
0800							97	29	84	88	36	96	76									
0900							95	31	87	82	37	98	73									
1000							95	32	89	79	38	100	69									
1100							95	33	92	77	39	102	65									
1200							95	34	94	75	40	104	62									
1300							95	34	94	74	41	105	59									
1400							95	35	95	74	41	105	59									
1500							95	35	95	74	41	105	59									
1600							95	34	93	76	41	105	59									
1700							95	33	92	79	39	102	65									
1800							95	32	90	82	37	99	69									
1900							97	31	88	86	36	97	73									
2000							98	29	85	91	34	94	79									
2100							100	28	83	95	33	91	85									
2200							100	28	82	96	32	90	85									
2300							100	27	81	100	32	89	88									
2400							100	27	80	100	31	88	88									

¹ Temperature and humidity values are for ambient air.

² For chamber control purpose, 100 percent RH implies as close to 100 percent RH as possible, but not less than 95 percent.

2.3.2 Test Duration.

The number of temperature - humidity cycles (total test time) is critical in achieving the purpose of the test. The durations provided in Table 507.6-II are minimum durations and, in most cases, are far less than necessary to provide an annual comparison. Apply the number of test cycles on a one-for-one basis, i.e., 45 cycles equates to 45 days in the natural environment, and is not related to any acceleration factor. For Procedure I, see Table 507.6-II and use the storage and transit durations for the appropriate cycle (B1, B2, or B3), followed by the corresponding natural cycle duration. For Procedure II guidance, see paragraph 2.3.2c below.

MIL-STD-810H
METHOD 507.6

NOTE: The climate station selected for these categories was Majuro, Marshall Islands (7°05' N, 171°23'E). The station is located at the Majuro Airport Weather Services building. This site is a first-order U.S. weather reporting station. Majuro was selected over 12 available candidate stations from around the world initially because it possessed the required temperature and precipitation characteristics for the B1 category (resulting in high temperature – humidity conditions), and it met the criteria for data availability and quality.

On the average, Majuro receives over 3,300 mm (130 inches) of rainfall annually. Over 250 days experience rainfall \geq 0.01 inch, and over 310 days experience rainfall \geq trace. Ten years of continuous data were used for the analysis (POR: 1973-1982).

Groupings of consecutive days of rainfall (and resulting humidity) were then extracted. The longest continuous streak of consecutive days \geq trace was 51. A cumulative frequency curve was then created. The recommended duration value of 45 days represents the 99th percentile value (actual value = 98.64%).

NOTE: During or after this test, document any degradation that could contribute to failure of the test item during more extensive exposure periods (i.e., indications of potential long term problems), or during exposure to other deployment environments such as shock and vibration. Further, extend testing for a sufficient period of time to evaluate the long-term effect of its realistic deployment duration (deterioration rate becomes asymptotic).

a. Procedure Ia - Induced (Storage and Transit) Cycles

- (1) Hazardous test items. Hazardous test items will generally require longer tests than nonhazardous items to establish confidence in test results. Since induced conditions are much more severe than natural conditions, potential problems associated with high temperature/high relative humidity will be revealed sooner, and the results can be analyzed with a higher degree of confidence. Consequently, expose hazardous test items to extended periods (double the normal periods) of conditioning, depending upon the geographical category to which the materiel will be exposed (see Table 507.6-II, induced cycles B1 through B3).
- (2) Non-hazardous test items. Induced conditions are much more severe than natural conditions, and potential problems associated with high temperature/high humidity will thus be revealed sooner, and the results can be analyzed, in most cases, with a higher degree of confidence. Expose non-hazardous test items to test durations as specified in Table 507.6-II, induced cycles B1 through B3, depending upon the geographical category to which the material will be exposed.

b. Procedure Ib - Natural Cycles

- (1) Hazardous test items. Hazardous test items are those in which any unknown physical deterioration sustained during testing could ultimately result in damage to materiel or injury or death to personnel when the test item is used. Hazardous test items will generally require longer test durations than nonhazardous test items to establish confidence in the test results. Twice the normal test duration is recommended (see Table 507.6-II, cycles B1 through B3).
- (2) Nonhazardous test items. Nonhazardous test items should be exposed from 15 to 45 cycles of conditioning, depending upon the geographical area to which the materiel will be exposed (see Table 507.6-II, cycles B1 through B3).

MIL-STD-810H
METHOD 507.6**Table 507.6-II. Test cycles (days).**

MATERIEL CATEGORY	NATURAL ¹			INDUCED (STORAGE and TRANSIT)		
	Cycle B1	Cycle B2	Cycle B3	Cycle B1	Cycle B2	Cycle B3
Hazardous Items Normal Test Duration	90	90	30	180	180	30
Non-Hazardous Items Normal Test Duration	45	45	15	90	90	15

¹ Perform operational checks at least once every five days; more frequent checks may provide early detection of potential problems.

- c. **Procedure II – Aggravated Cycle.** For Procedure II, in addition to a 24-hour conditioning cycle (paragraph 4.4.2.2), the minimum number of 24-hour cycles for the test is ten. Although the combined 60 °C (140 °F) and 95 percent RH does not occur in nature, this combination of temperature and relative humidity, has historically proven adequate to reveal potential effects in most materiel. Extend the test as specified in the test plan to provide a higher degree of confidence in the materiel to withstand warm, humid conditions. For the test items incorporating seals to protect moisture-sensitive materials, e.g., pyrotechnics, longer test durations may be required.

2.3.3 Test Item Configuration. During conduct of the temperature-humidity procedures of this Method, configure the test item as specified below, or as specifically outlined in the requirements documents. Test item configuration must be selected to reproduce, as closely as technically possible, the configuration that the test item would assume when worst-case situations are encountered during its life cycle.

- In its assigned shipping/storage container, or as installed in the end item.
- Out of its shipping/storage container but not set up in its deployment mode.
- In its operational mode (realistically or with restraints, such as with openings that are normally covered).

2.3.4. Additional Guidelines. Review the requirements documents. Apply any additional guidelines necessary.

2.4 Operational Checkout.

2.4.1 Procedure I (Induced Cycles B1, B2, or B3, Followed By Natural Cycles B1, B2, or B3)

- Procedure Ia:** Induced (storage and transit) cycles B1, B2, and B3 represent storage and transit environments. As such, perform operational checkouts before and after each test.
- Procedure Ib:** Natural cycles B1 - B3 represent the operational environment, and, theoretically, the materiel could be functioning non-stop in the natural environment. In this case, operate the test item continuously throughout the test procedure. If shorter operational periods are identified in the requirements document(s), operate the test item at least once every five cycles for a duration necessary to verify proper operation. This operational checkout will help determine effects of the natural cycles on test item(s) as soon as possible.

2.4.2 Procedure II - Aggravated.

Procedure II does not represent naturally-occurring conditions; therefore it may produce an acceleration of potential temperature-humidity effects. If the test item is intended to be operated in a warm, humid environment, perform at least one operational checkout every five cycles during the periods shown on Figure 507.6-7.

2.5 Test Variations.

The most important ways the tests can vary are in the number of temperature-humidity cycles, relative humidity, and temperature levels and durations, test item performance monitoring (where appropriate), and test item ventilation.

2.6 Philosophy of Testing.

Procedures Ia and Ib are intended to reveal representative effects that typically occur when materiel is exposed to elevated temperature-humidity conditions in storage and transit, followed by actual service where moderate to high instances of such an environment exist. (See paragraph 2.1.1 above for categories and examples of these effects.)

MIL-STD-810H
METHOD 507.6

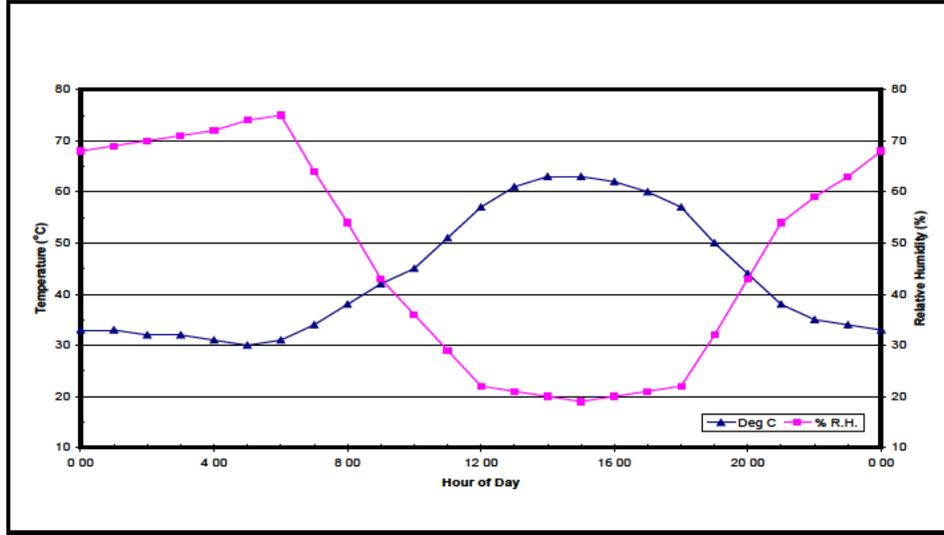


Figure 507.6-2. Induced Cycle B2 - Storage and transit.

Table 507.6-IV. Cyclic high relative humidity - Induced cycle B2.

Time	Temp.		RH Percent	Time	Temp.		RH Percent
	°C	°F			°C	°F	
0100	33	91	69	1300	61	142	21
0200	32	90	70	1400	63	145	20
0300	32	90	71	1500	63	145	19
0400	31	88	72	1600	62	144	20
0500	30	86	74	1700	60	140	21
0600	31	88	75	1800	57	134	22
0700	34	93	64	1900	50	122	32
0800	38	101	54	2000	44	111	43
0900	42	107	43	2100	38	101	54
1000	45	113	36	2200	35	95	59
1100	51	124	29	2300	34	93	63
1200	57	134	22	2400	33	91	68

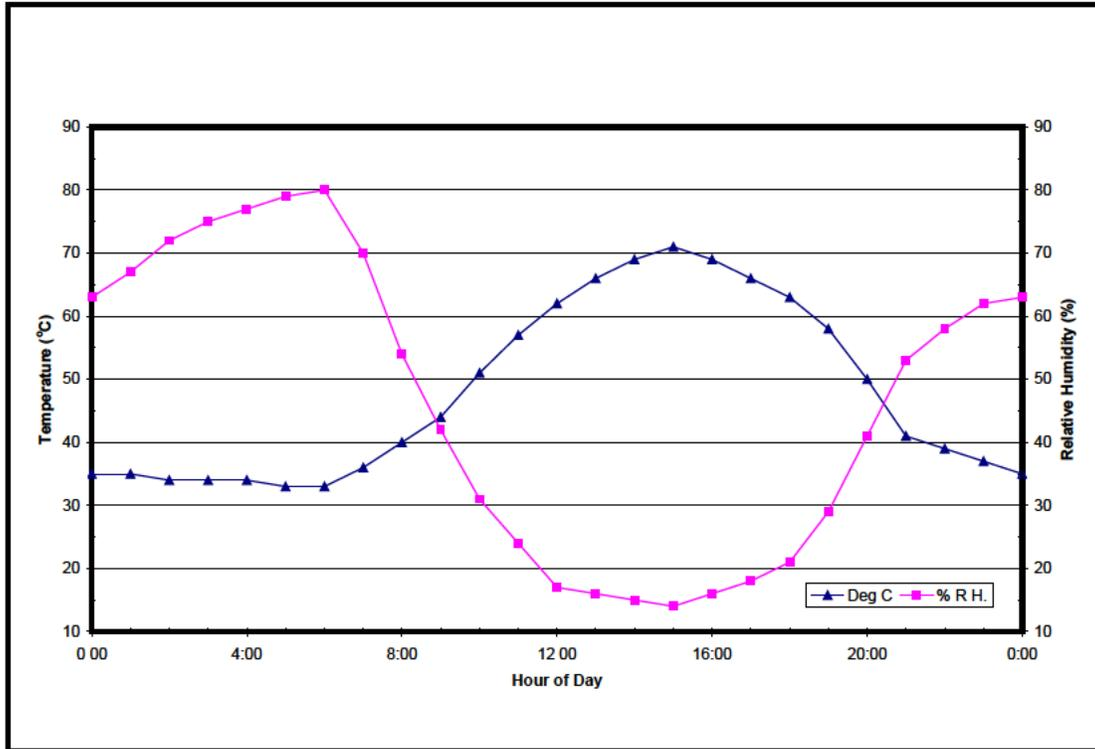
MIL-STD-810H
METHOD 507.6

Figure 507.6-3. Induced Cycle B3 - Storage and transit.

Table 507.6-V. Hot Humid - Induced Cycle B3.

Time	Temp.		RH	Time	Temp.		RH
	°C	°F	Percent		°C	°F	Percent
0100	35	95	67	1300	66	151	16
0200	34	94	72	1400	69	156	15
0300	34	94	75	1500	71	160	14
0400	34	93	77	1600	69	156	16
0500	33	92	79	1700	66	151	18
0600	33	91	80	1800	63	145	21
0700	36	97	70	1900	58	136	29
0800	40	104	54	2000	50	122	41
0900	44	111	42	2100	41	105	53
1000	51	124	31	2200	39	103	58
1100	57	135	24	2300	37	99	62
1200	62	144	17	2400	35	95	63

2.6.2 Procedure I - Natural Cycles.

Three natural cycles in Table 507.6-I and Figures 507.6-4 through 507.6-6 reflect data in specific climatic regions as identified in AR 70-38 (paragraph 6.1, reference a) and NATO STANAG 4370, AECTP 230 (paragraph 6.1, reference c). The complex temperature/humidity/solar radiation environment with its associated antagonistic elements such as microbial growth, acidic atmosphere, and other biological elements produce synergistic effects that cannot be practically duplicated in the laboratory. Coupled with these test data interpretation problems are the

MIL-STD-810H
METHOD 507.6

extensive durations of real-world environments that, in most cases, are too lengthy to realistically apply in the laboratory. Before undertaking such laboratory testing, consider testing in the natural environment. Otherwise, exercise caution in applying such cycles and in interpreting test results.

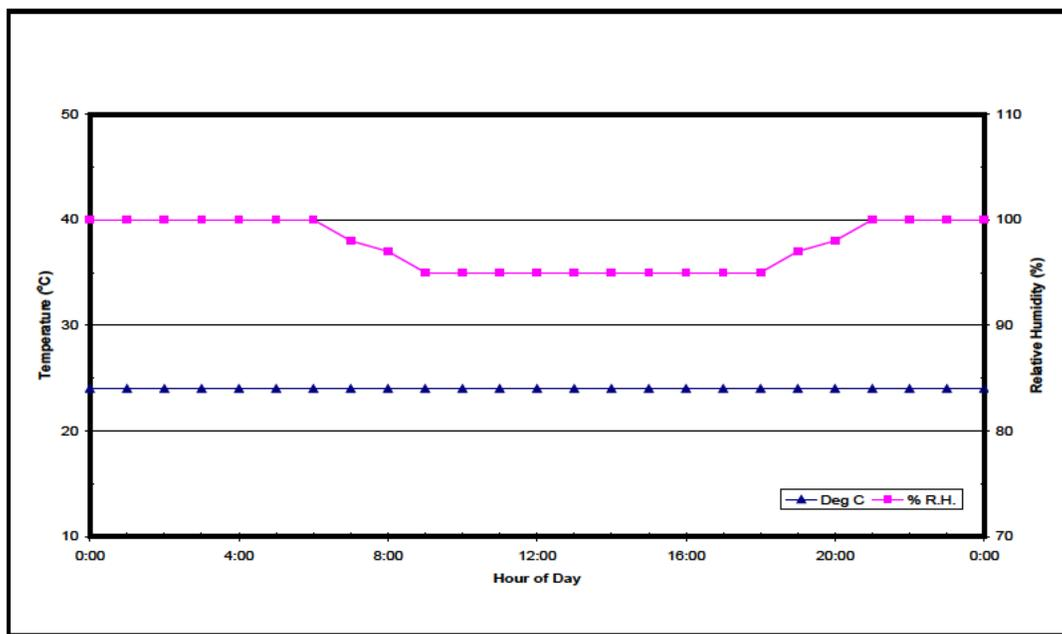


Figure 507.6-4. Natural Cycle B1 – Constant high humidity.

Table 507.6-VI. Constant temperature and humidity - Natural Cycle B1.

Time	Temp.		RH Percent	Time	Temp.		RH Percent
	°C	°F			°C	°F	
0100	Nearly constant at 24°C (75°F) throughout the 24 hours.		100	1300			95
0200			100	1400			95
0300			100	1500			95
0400			100	1600			95
0500			100	1700			95
0600			100	1800			95
0700			98	1900			97
0800			97	2000			98
0900			95	2100			100
1000			95	2200			100
1100			95	2300			100
1200			95	2400			100

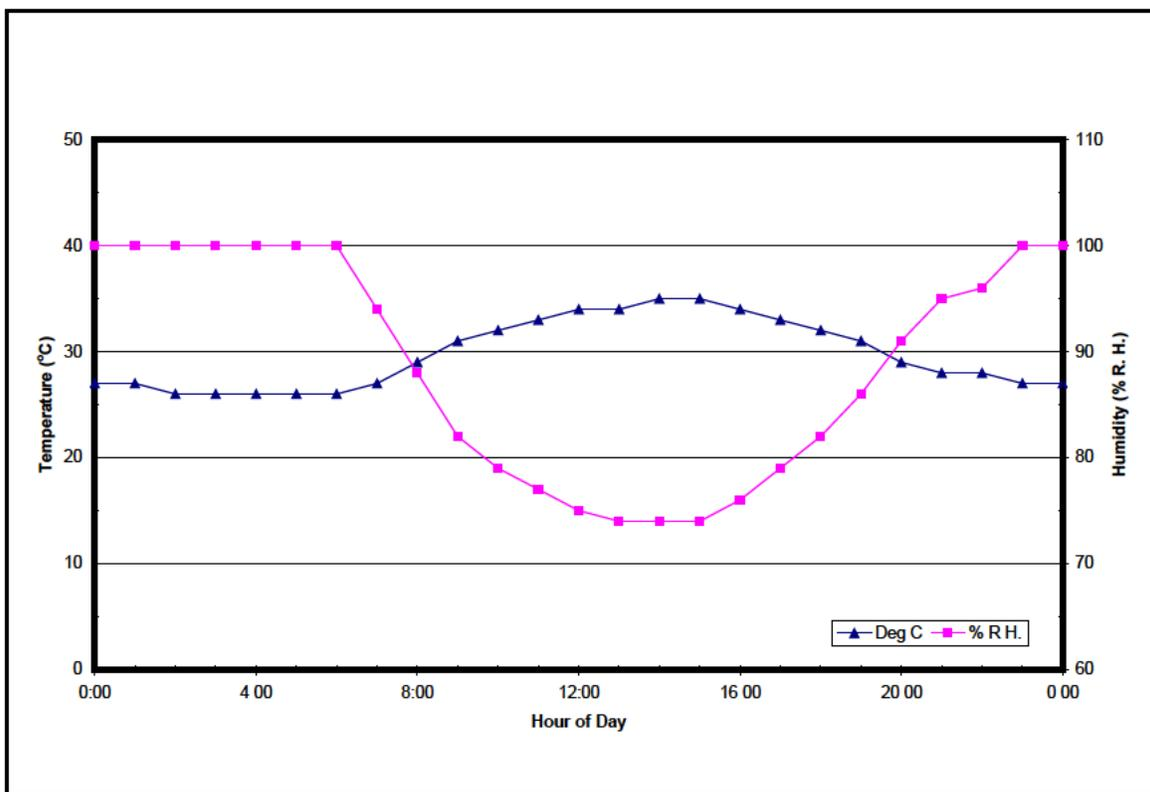
MIL-STD-810H
METHOD 507.6

Figure 507.6-5. Natural Cycle B2 – Cyclic high humidity.

Table 507.6-VII. Cyclic high relative humidity – Natural Cycle B2.

Time	Temp.		RH Percent	Time	Temp.		RH Percent
	°C	°F			°C	°F	
0100	27	80	100	1300	34	94	74
0200	26	79	100	1400	35	95	74
0300	26	79	100	1500	35	95	74
0400	26	79	100	1600	34	94	76
0500	26	78	100	1700	33	92	79
0600	26	78	100	1800	32	90	82
0700	27	81	94	1900	31	88	86
0800	29	84	88	2000	29	85	91
0900	31	87	82	2100	28	83	95
1000	32	89	79	2200	28	82	96
1100	33	92	77	2300	27	81	100
1200	34	94	75	2400	27	80	100

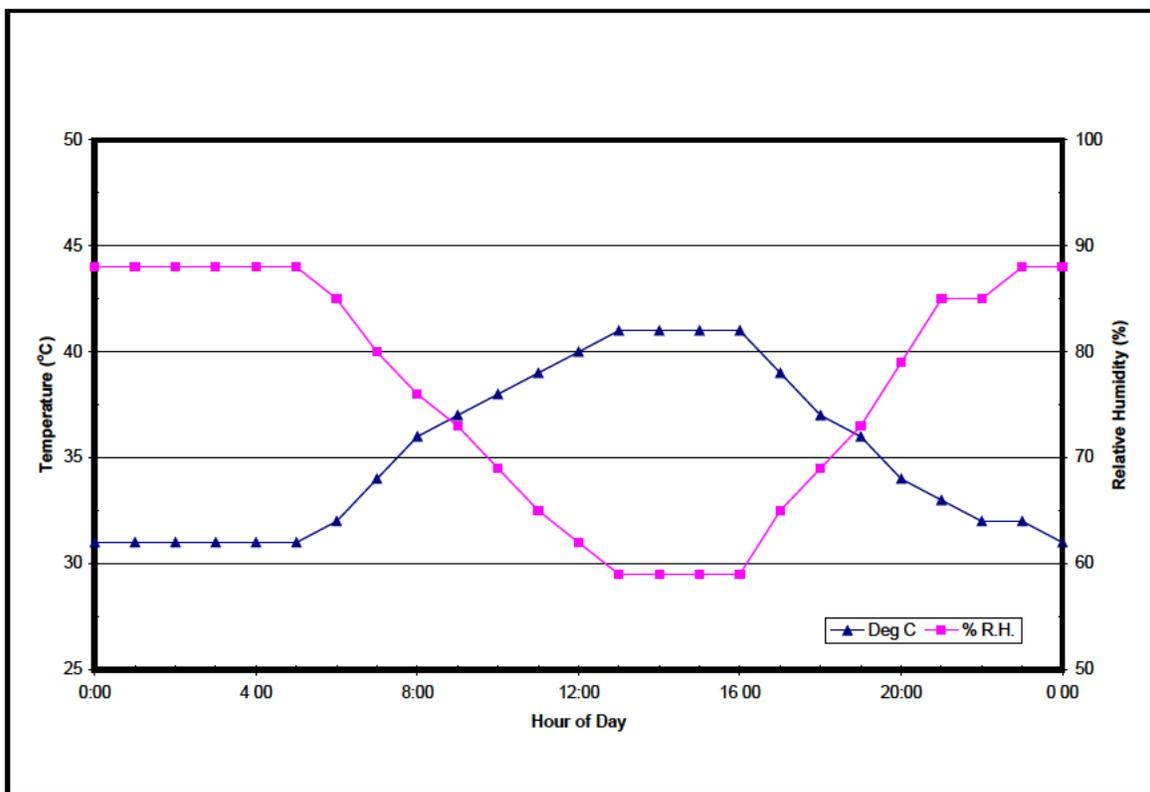
MIL-STD-810H
METHOD 507.6

Figure 507.6-6. Natural Cycle B3 - Hot humid.

Table 507.6-VIII. Hot Humid - Natural Cycle B3.

Time	Temp.		RH Percent	Time	Temp.		RH Percent
	°C	°F			°C	°F	
0100	31	88	88	1300	41	105	59
0200	31	88	88	1400	41	105	59
0300	31	88	88	1500	41	105	59
0400	31	88	88	1600	41	105	59
0500	31	88	88	1700	39	102	65
0600	32	90	85	1800	37	99	69
0700	34	93	80	1900	36	97	73
0800	36	96	76	2000	34	94	79
0900	37	98	73	2100	33	91	85
1000	38	100	69	2200	32	90	85
1100	39	102	65	2300	32	89	88
1200	40	104	62	2400	31	88	88

2.6.3 Procedure II - Aggravated Cycle (Figure 507.6-7).

The purpose of the aggravated test procedure is to produce representative effects that typically occur when material is exposed to elevated temperature-humidity conditions. (See paragraph 2.1.1 above for categories and examples of

MIL-STD-810H
METHOD 507.6

these effects.) Accordingly, this procedure does not reproduce naturally occurring or service-induced temperature-humidity scenarios. It may induce problems that are indicative of long-term effects. Test item failures do not necessarily indicate failures in the real environment.

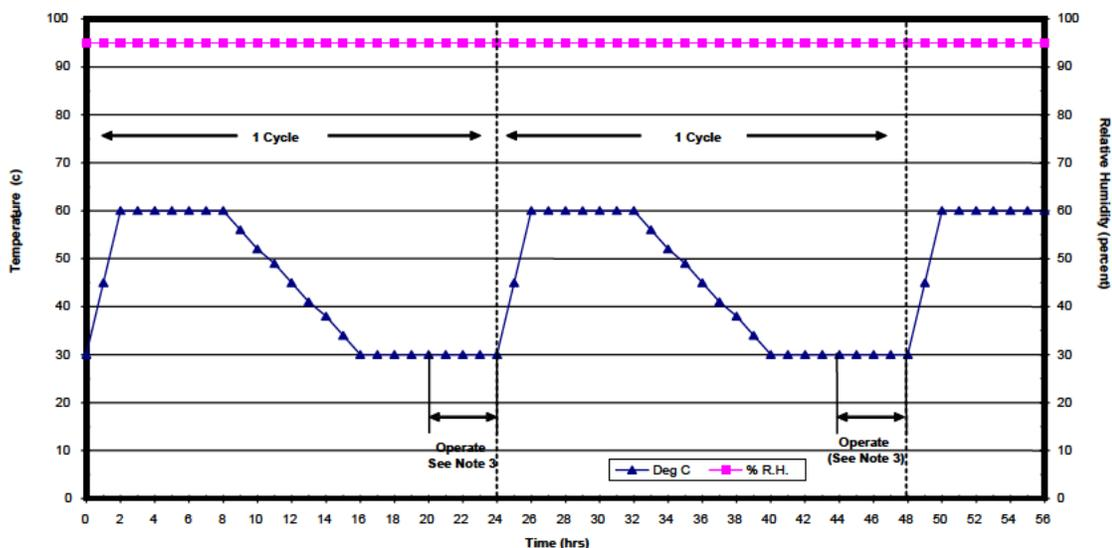


Figure 507.6-7. Aggravated temperature-humidity cycle.

NOTES:

1. Maintain the relative humidity at 95 ± 4 percent at all times except that during the descending temperature periods the relative humidity may drop to as low as 85 percent.
2. A cycle is 24 hours.
3. Perform operational checks near the end of the fifth and tenth cycles.

Table 507.6-IX. Aggravated cycle.

Time	Temp.		RH Percent
	°C	°F	
0000	30	86	Constant at 95 percent
0200	60	140	
0800	60	140	
1600	30	86	
2400	30	86	
0200	60	140	
0800	60	140	
1600	30	86	
2400	30	86	

3. INFORMATION REQUIRED.

3.1 Pretest.

The following information is required to conduct humidity tests adequately.

- a. General. Information listed in Part One, paragraphs 5.7 and 5.9, and Annex A, Task 405 of this Standard.
- b. Specific to this Method.
 - (1) Any sealed areas of the test item to be opened during testing or vice versa.

MIL-STD-810H
METHOD 507.6

- (2) If an operational test procedure is required following the Induced (Storage and Transit) test.
 - (3) Periods of materiel operation or designated times for visual examinations (see paragraph 2.4.1).
 - (4) Operating test procedures, if appropriate.
- c. Tailoring. Necessary variations in the basic test procedures to accommodate environments identified in the LCEP.

3.2 During Test.

Collect the following information during conduct of the test:

- a. General. Information listed in Part One, paragraph 5.10, and in Annex A, Tasks 405 and 406 of this Standard.
- b. Specific to this Method.
 - (1) Record of chamber temperature and humidity versus time conditions.
 - (2) Test item performance data and time/duration of checks.

3.3 Post-Test.

The following post test data shall be included in the test report.

- a. General. Information listed in Part One, paragraph 5.13, and in Annex A, Task 406 of this Standard.
- b. Specific to this Method.
 - (1) Previous test methods to which the test item has been subjected.
 - (2) Results of each operational check (before, during, and after test) and visual examination (and photographs, if applicable).
 - (3) Length of time required for each operational check.
 - (4) Exposure durations and/or number of test cycles.
 - (5) Test item configuration and special test setup provisions.
 - (6) Any deviation from published cycles / procedures.
 - (7) Any deviations from the original test plan.

4. TEST PROCESS.**4.1 Test Facility.**

Ensure the apparatus used in performing the humidity test includes the following:

4.1.1 General Description.

The required apparatus consists of a chamber or cabinet, and auxiliary instrumentation capable of maintaining and monitoring (see Part One, paragraph 5.18) the required conditions of temperature and relative humidity throughout an envelope of air surrounding the test item. (See Part One, paragraph 5.)

4.1.2 Facility Design.

Unless otherwise specified, use a test chamber or cabinet with a test volume and the accessories contained therein constructed and arranged in such a manner as to prevent condensate from dripping on the test item. Vent the test volume to the atmosphere to prevent the buildup of total pressure and prevent contamination from entering.

4.1.3 Test Sensors and Measurements.

Determine the relative humidity by employing either solid state sensors whose calibration is not affected by water condensation, or by an equivalent method such as fast-reacting wet-bulb/dry-bulb sensors or dew point indicators. Sensors that are sensitive to condensation, such as the lithium chloride type, are not recommended for tests with high relative humidity levels. A data collection system, including an appropriate recording device(s), separate from the chamber controllers is necessary to measure test volume conditions. If charts are used, use charts readable to

MIL-STD-810H
METHOD 507.6

within ± 0.6 °C (± 1 °F). If the wet-wick control method is approved for use, clean the wet bulb and tank and install a new wick before each test and at least every 30 days. Ensure the wick is as thin as realistically possible to facilitate evaporation (approximately 1/16 in. thick) consistent with maintaining a wet surface around the sensor. Use water in wet-wick systems that is of the same quality as that used to produce the humidity (see Part One, paragraph 5.16). When physically possible, visually examine the water bottle, wick, sensor, and other components making up relative humidity measuring systems at least once every 24 hours during the test to ensure they are functioning as desired.

4.1.4 Air Velocity.

Use an air velocity flowing across the wet bulb sensor of not less than 4.6 meters/second (900 feet/minute, or as otherwise specified in sensor response data), and ensure the wet wick is on the suction side of the fan to eliminate the effect of fan heat. Maintain the flow of air anywhere within the envelope of air surrounding the test item between 0.5 and 1.7 meters/second (98 to 335 feet/minute).

4.1.5 Humidity Generation.

Use steam or water injection to create the relative humidity within the envelope of air surrounding the test item. Use water as described in Part One, paragraph 5.16. Verify its quality at periodic intervals (not to exceed 15 days) to ensure its acceptability. If water injection is used to humidify the envelope of air, temperature-condition it before its injection to prevent upset of the test conditions, and do not inject it directly into the test section. From the test volume, drain and discard any condensate developed within the chamber during the test so as to not reuse the water.

4.1.6 Contamination Prevention.

Do not bring any material other than water into physical contact with the test item(s) that could cause the test item(s) to deteriorate or otherwise affect the test results. Do not introduce any rust or corrosive contaminants or any material other than water into the chamber test volume. Achieve dehumidification, humidification, heating and cooling of the air envelope surrounding the test item by methods that do not change the chemical composition of the air, water, or water vapor within that volume of air.

4.2 Controls.

- a. Measurement and recording device(s). Ensure the test chamber includes an appropriate measurement and recording device(s), separate from the chamber controllers.
- b. Test parameters. Unless otherwise specified, make continuous analog temperature and relative humidity measurements during the test. Conduct digital measurements at intervals of 15 minutes or less.
- c. Capabilities. Use only instrumentation with the selected test chamber that meets the accuracies, tolerances, etc., of Part One, paragraph 5.3.

4.3 Test Interruption.

Test interruptions can result from two or more situations, one being from failure or malfunction of test chambers or associated laboratory test equipment. The second type of test interruption results from failure or malfunction of the test item itself during operational checks.

4.3.1 Interruption Due to Chamber Malfunction.

- a. General. See Part One, paragraph 5.11, of this Standard.
- b. Specific to this Method.
 - (1) Undertest interruption. If an unscheduled interruption occurs that causes the test conditions to fall below allowable limits, the test must be reinitiated at the end of the last successfully completed cycle.
 - (2) Overtest interruptions. If the test item(s) is exposed to test conditions that exceed allowable limits, conduct an appropriate physical examination of the test item and perform an operational check (when practical) before testing is resumed. This is especially true where a safety condition could exist, such as with munitions. If a safety condition is discovered, the preferable course of action is to terminate the test and reinitiate testing with a new test item. If this is not done and test item failure occurs during the remainder of the test, the test results may be considered invalid. If no problem has been encountered during the operational checkout or the visual inspection, reestablish pre-interruption

MIL-STD-810H
METHOD 507.6

conditions and continue from the point where the test tolerances were exceeded. See paragraph 4.3.2 for test item operational failure guidance.

4.3.2 Interruption Due to Test Item Operation Failure.

Failure of the test item(s) to function as required during operational checks presents a situation with several possible options.

- a. The preferable option is to replace the test item with a “new” one and restart from Step 1.
- b. A second option is to replace / repair the failed or non-functioning component or assembly with one that functions as intended, and restart the entire test from Step 1.

NOTE: When evaluating failure interruptions, consider prior testing on the same test item and consequences of such.

4.4 Test Execution.

The following steps, alone or in combination, provide the basis for collecting necessary information concerning the test item in a warm, humid environment.

4.4.1 Preparation for Test.

4.4.1.1 Test Setup.

- a. General. See Part One, paragraph 5.8.
- b. Unique to this Method. Verify that environmental monitoring and measurement sensors are of an appropriate type and properly located to obtain the required test data.

4.4.1.2 Preliminary Steps.

Before starting the test, determine the test details (e.g., procedure variations, test item configuration, cycles, durations, parameter levels for storage/operation, etc.) from the test plan.

4.4.1.3 Pretest Checkout.

All items require a pretest checkout at standard ambient conditions to provide baseline data. Conduct the checkout as follows:

- Step 1. Install appropriate instrumentation, e.g., thermocouples, in or on the test item.
- Step 2. Install the test item into the test chamber and prepare the test item in its storage and/or transit configuration in accordance with Part One, paragraph 5.8.1.
- Step 3. Conduct a thorough visual examination of the test item to look for conditions that could compromise subsequent test results.
- Step 4. Document any significant results.
- Step 5. Conduct an operational checkout (if appropriate) in accordance with the test plan, and record results.
- Step 6. If the test item operates satisfactorily, proceed to the appropriate test procedure. If not, resolve the problems and repeat Step 5 above.

4.4.2 Test Procedures.

4.4.2.1 Procedure I - Storage and Transit Cycles (Cycles B2 or B3), and Natural (Cycles B1, B2, or B3).

- Step 1. With the test item in the chamber, ensure it is in its storage and/or transit configuration, adjust the chamber temperature to 23 ± 2 °C (73 ± 3.6 °F) and 50 ± 5 percent RH, and maintain for no less than 24 hours.
- Step 2. Adjust the chamber temperature and relative humidity to those shown in the appropriate induced (storage and transit) category of Table 507.6-I for time 2400.

MIL-STD-810H
METHOD 507.6

- Step 3. Unless other guidance is provided by the test plan, cycle the chamber air temperature and RH with time as shown in the appropriate storage and transit cycle of Table 507.6-I (or in the appropriate approximated curve from Figures 507.6-1, 507.6-2, or 507.6-3) through the 24-hour cycle, and for the number of cycles indicated in Table 507.6-II for the appropriate climatic category.
- Step 4. Adjust the chamber temperature to 23 ± 2 °C (73 ± 3.6 °F) and 50 ± 5 percent RH, and maintain until the test item has reached temperature stabilization (generally not more than 24-hours).
- Step 5. If only a storage and/or transit test is required, go to Step 15.
- Step 6. Conduct a complete visual checkout of the test item and document the results.
- Step 7. Put the test item in its normal operating configuration.
- Step 8. Conduct a complete operational checkout of the test item and document the results. If the test item fails to operate as intended, follow the guidance in paragraph 4.3.2 for test item failure. Otherwise, go to Step 9.
- Step 9. Compare these data with the pretest data.
- Step 10. Adjust the test item configuration to that required for naturally occurring temperature humidity cycles (B1, B2, or B3).
- Step 11. Adjust the chamber conditions to those given in Table 507.6-I for the time 2400 of the specified cycle.
- Step 12. Perform 24-hour cycles for the number of cycles indicated in Table 507.6-II for the appropriate climatic category with the time-temperature-humidity values specified in Table 507.6-I, or the appropriate approximated curve of Figures 507.6-4 through 507.6-6.
- Step 13. If the materiel (test item) could be functioning non-stop in the natural environment, operate the test item continuously throughout the test procedure. If shorter operational periods are identified in the requirements document(s), operate the test item at least once every five cycles, and during the last cycle, for the duration necessary to verify proper operation. If the test item fails to operate as intended, follow the guidance in paragraph 4.3.2 for test item failure.
- Step 14. Adjust the chamber temperature to 23 ± 2 °C (73 ± 3.6 °F) and 50 ± 5 percent RH, and maintain until the test item has reached temperature stabilization (generally not more than 24-hours).
- Step 15. Conduct a complete visual examination of the test item and document the results.
- Step 16. Conduct an operational checkout of the test item in accordance with the approved test plan, and document the results. See paragraph 5 for analysis of results.
- Step 17. Compare these data with the pretest data.

4.4.2.2 Procedure II - Aggravated.

This test consists of a 24-hour conditioning period (to ensure all items at any intended climatic test location will start with the same conditions), followed by a series of 24-hour temperature and humidity cycles for a minimum of 10 cycles, or a greater number as otherwise specified in the test plan, unless premature facility or test item problems arise.

- Step 1. With the test item installed in the test chamber in its required configuration, adjust the temperature to 23 ± 2 °C (73 ± 3.6 °F) and 50 ± 5 percent RH, and maintain for no less than 24 hours.
- Step 2. Adjust the chamber temperature to 30 °C (86 °F) and the RH to 95 percent.
- Step 3. Expose the test item(s) to at least ten 24-hour cycles ranging from 30-60 °C (86-140 °F) (Figure 507.6-7) or as otherwise determined in paragraph 2.2.1. Unless otherwise specified in the test plan, conduct a test item operational check (for the minimum time required to verify performance) near the end of the fifth and tenth cycles during the periods shown in Figure 507.6-7, and

MIL-STD-810H
METHOD 507.6

document the results. If the test item fails to operate as intended, follow the guidance in paragraph 4.3.2 for test item failure. Otherwise, continue with Step 4.

NOTE: If the operational check requires the chamber to be open or the test item to be removed from the chamber, and the check cannot be completed within 30 minutes, in order to prevent unrealistic drying, recondition the test item at $30^{\circ}\text{C} \pm 2^{\circ}\text{C}$ ($86^{\circ}\text{F} \pm 4^{\circ}\text{F}$) and 95 percent RH for one hour, and then continue the checkout. Extend the test time for that cycle by one hour. Continue this sequence until the checkout has been completed.

If the operational check is conducted in the chamber, and extends beyond the 4-hour period noted in Figure 507.6-7, do not proceed to the next cycle until the checkout is completed. Once the check has been completed resume the test.

- Step 4. At the completion of 10 or more successful cycles, adjust the temperature and humidity to $23 \pm 2^{\circ}\text{C}$ ($73 \pm 3.6^{\circ}\text{F}$) and 50 ± 5 percent RH, and maintain until the test item has reached temperature stabilization (generally not more than 24-hours).
- Step 5. Perform a thorough visual examination of the test item, and document any conditions resulting from test exposure.
- Step 6. Conduct a complete operational checkout of the test item and document the results. See paragraph 5 for analysis of results.
- Step 7. Compare these data with the pretest data.

5. ANALYSIS OF RESULTS.

In addition to the guidance provided in Part One, paragraphs 5.14 and 5.17, the following information is provided to assist in the evaluation of the test results.

- a. Allowable or acceptable degradation in operating characteristics.
- b. Possible contributions from special operating procedures or special test provisions needed to perform testing.
- c. Whether it is appropriate to separate temperature effects from humidity effects.
- d. Any deviations from the test plan.

6. REFERENCE/RELATED DOCUMENTS.

6.1 Referenced Documents.

- a. AR 70-38, Research, Development, Test and Evaluation of Materiel for Extreme Climatic Conditions; 1 August 1979.
- b. MIL-HDBK-310, Global Climatic Data for Developing Military Products; 23 June 1997.
- c. NATO STANAG 4370, Allied Environmental Conditions and Test Publication (AECTP) 230; Climatic Conditions.
- d. NATO STANAG 4370, Environmental Testing; 19 April 2005.
- e. Allied Environmental Conditions and Test Publication (AECTP) 200, Environmental Conditions (under STANAG 4370), January 2006

6.2 Related Documents.

- a. Synopsis of Background Material for MIL-STD-210B, Climatic Extremes for Military Equipment. Bedford, MA: Air Force Cambridge Research Laboratories, 24 January 1974. DTIC number AD-780-508.
- b. Allied Environmental Conditions and Test Publication (AECTP) 300, Climatic Environmental Tests (under STANAG 4370), Method 306; January 2006.

MIL-STD-810H
METHOD 507.6

- c. Egbert, Herbert W. "The History and Rationale of MIL-STD-810 (Edition 2)," January 2010; Institute of Environmental Sciences and Technology, Arlington Place One, 2340 S. Arlington Heights Road, Suite 100, Arlington Heights, IL 60005-4516.

(Copies of Department of Defense Specifications, Standards, and Handbooks, and International Standardization Agreements are available online at <https://assist.dla.mil>.)

Requests for other defense-related technical publications may be directed to the Defense Technical Information Center (DTIC), ATTN: DTIC-BR, Suite 0944, 8725 John J. Kingman Road, Fort Belvoir VA 22060-6218, 1-800-225-3842 (Assistance--selection 3, option 2), <http://www.dtic.mil/dtic/>; and the National Technical Information Service (NTIS), Springfield VA 22161, 1-800-553-NTIS (6847), <http://www.ntis.gov/>.

MIL-STD-810H
METHOD 507.6, ANNEX A

METHOD 507.6, ANNEX A

PHYSICAL PHENOMENA ASSOCIATED WITH HUMIDITY

1. ABSORPTION.

The accumulation of water molecules within material. The quantity of water absorbed depends, in part, on the water content of the ambient air. The process of absorption occurs continuously until equilibrium is reached. The penetration speed of the molecules in the water increases with temperature.

2. ADSORPTION.

The adherence of water vapor molecules to a surface whose temperature is higher than the dew point. The quantity of moisture that can adhere to the surface depends on the type of material, its surface condition, and the vapor pressure. An estimation of the effects due solely to adsorption is not an easy matter because the effects of absorption, that occurs at the same time, are generally more pronounced.

3. BREATHING.

Air exchange between a hollow space and its surroundings caused by temperature variations. This commonly induces condensation inside the hollow space.

4. CONDENSATION.

The precipitation of water vapor on a surface whose temperature is lower than the dew point of the ambient air. As a consequence, the water is transformed from the vapor state to the liquid state.

The dew point depends on the quantity of water vapor in the air. The dew point, the absolute humidity, and the vapor pressure are directly interdependent. Condensation occurs on a test item when the temperature at the surface of the item placed in the test chamber is lower than the dew point of the air in the chamber. As a result, the item may need to be preheated to prevent condensation.

Generally speaking, condensation can only be detected with certainty by visual inspection. This, however, is not always possible, particularly with small objects having a rough surface. If the test item has a low thermal constant, condensation can only occur if the air temperature increases abruptly, or if the relative humidity is close to 100 percent. Slight condensation may be observed on the inside surface of box structures resulting from a decrease in the ambient temperature.

5. DIFFUSION.

The movement of water molecules through material caused by a difference in partial pressures. An example of diffusion often encountered in electronics is the penetration of water vapor through organic coatings such as those on capacitors or semiconductors, or through the sealing compound in the box.

MIL-STD-810H
METHOD 507.6, ANNEX A

(This page is intentionally blank.)

MIL-STD-810H
METHOD 508.8**METHOD 508.8****FUNGUS****CONTENTS**

<u>Paragraph</u>	<u>Page</u>
1. SCOPE	1
1.1 PURPOSE	1
1.2 APPLICATION	1
1.3 LIMITATIONS.....	1
2. TAILORING GUIDANCE	1
2.1 SELECTING THE FUNGUS METHOD.....	1
2.1.1 EFFECTS OF FUNGUS GROWTH.....	2
2.1.1.1 DETRIMENTAL EFFECTS	2
2.1.1.2 PHYSICAL INTERFERENCE	2
2.1.1.3 HEALTH AND AESTHETIC FACTORS.....	2
2.1.2 SEQUENCE AMONG OTHER TEST METHODS.....	3
2.2 SELECTING PROCEDURE VARIATIONS	3
2.2.1 TEST DURATION.....	3
2.2.2 CHOICE OF FUNGUS.....	3
3. INFORMATION REQUIRED.....	3
3.1 PRETEST.....	3
3.2 DURING TEST	4
3.3 POST-TEST	5
4. TEST PROCESS	5
4.1 TEST FACILITY	5
4.1.1 TEST CHAMBER.....	5
4.1.2 SENSORS	5
4.1.3 AIR VELOCITY	5
4.1.4 DECONTAMINATION.....	6
4.2 CONTROLS	6
4.2.1 RELATIVE HUMIDITY	6
4.2.2 CIRCULATION.....	6
4.2.3 STEAM	6
4.2.4 UNLESS OTHERWISE SPECIFIED	6
4.3 TEST INTERRUPTION	6
4.3.1 INTERRUPTION DUE TO CHAMBER MALFUNCTION	6
4.3.2 INTERRUPTION DUE TO TEST ITEM OPERATION FAILURE	7
4.4 TEST EXECUTION	7
4.4.1 CLEANING.....	7
4.4.2 MISCELLANEOUS.....	7
4.4.3 PREPARATION FOR TEST.....	8
4.4.3.1 PREPARATION FOR MINERAL SALTS SOLUTION	8
4.4.3.2 PREPARATION FOR MIXED SPORE SUSPENSION.....	8
4.4.3.3 CONTROL ITEMS.....	9
4.5 TEST PROCEDURE	10
4.5.1 PREPARATION FOR INCUBATION.....	10
4.5.2 INCUBATION OF THE TEST ITEM.....	11

MIL-STD-810H
METHOD 508.8

CONTENTS - Continued

<u>Paragraph</u>	<u>Page</u>
4.5.3 INSPECTION.....	11
4.5.4 OPERATION/USE	11
4.6 DECONTAMINATION.....	11
5. ANALYSIS OF RESULTS	11
6. REFERENCE/RELATED DOCUMENTS	12
6.1 REFERENCED DOCUMENTS.....	12
6.2 RELATED DOCUMENTS.....	12

TABLES

TABLE 508.8-I. US TEST FUNGUS	4
TABLE 508.8-II. EVALUATION SCHEME FOR VISIBLE EFFECTS.....	12

**METHOD 508.8 ANNEX A
DECONTAMINATION OF TEST EQUIPMENT AND TEST ITEMS AFTER EXPOSURE TO FUNGUS**

**METHOD 508.8 ANNEX B
FUNGUS-INERT MATERIALS**

TABLE

TABLE 508.8B-I. FUNGI SUSCEPTIBILITY OF MATERIALS.....	B-1
--	-----

MIL-STD-810H
METHOD 508.8**METHOD 508.8**
FUNGUS

NOTE: Tailoring is essential. Select methods, procedures and parameter levels based on the tailoring process described in Part One, paragraph 4.2.2, and Annex C. Apply the general guidelines for laboratory test methods described in Part One, paragraph 5 of this Standard.

1. SCOPE.**1.1 Purpose.**

The purpose of this fungus test is to assess the susceptibility of materials to fungal growth. The primary objectives of the fungus test are to determine:

- a. If the materials or the assembled combination of same, will support fungal growth, and where possible, identify dominant species present.
- b. How rapidly fungus will grow on the materiel.
- c. How fungus may affect the materiel, its mission, and its safety for use following the growth of fungus on the materiel.
- d. If the materiel can be stored effectively in a field environment.
- e. If there are simple cleaning processes.

1.2 Application.

Since microbial deterioration is a function of temperature and humidity, and is an inseparable condition of the a hot, humid environment and the mid-latitudes tropics, consider it in the design of all standard, general-purpose materiel (from paragraph 6.1, reference a). This method is used to determine if fungal growth will occur and, if so, how it may degrade/impact the use of the materiel.

NOTES: 1. This test procedure and the accompanying preparation and post-test analysis involve highly-specialized techniques and potentially-hazardous organisms. Use only technically-qualified personnel (e.g., microbiologists, trained technicians) to perform the test.

2. Although the basic (documented) resistance of materials to fungal growth (Annex B) is helpful in the design of new materiel, it has shown to be unreliable in determining the fungal susceptibility of complex materials. The use of testing by analysis is discouraged. The physical structure of combined materials and the possible contamination of resistant materials during manufacture are beyond the purview of analysis, and necessitate laboratory or natural environment tests to verify the resistance of the assembled materials to fungal growth.

1.3 Limitations.

This test is designed to obtain data on the susceptibility of materiel. This method is not intended for but may be used to test basic materials since various other test procedures, including pure culture, mixed culture, and plate testing are available.

2. TAILORING GUIDANCE.**2.1 Selecting the Fungus Method.**

After examining requirements documents and applying the tailoring process in Part One of this Standard to determine where fungal growth is anticipated in the life cycle of materiel, use the following to confirm the need for this Method and to place it in sequence with other methods.

MIL-STD-810H
METHOD 508.8

2.1.1 Effects of Fungus Growth.

Fungal growth impairs the functioning or use of materiel by changing its physical properties.

2.1.1.1 Detrimental Effects.

The detrimental effects of fungal growth are summarized as follows:

- a. Direct Attack on Materials. Nonresistant materials are susceptible to direct attack as the fungus breaks the materials down and uses them as nutrients. This results in deterioration affecting the physical properties of the material. Examples of nonresistant materials are:
 - (1) Natural Materials. Products of natural origin are most susceptible to this attack.
 - (a) Cellulosic materials (e.g., wood, paper, natural fiber textiles, and cordage).
 - (b) Animal- and vegetable-based adhesives.
 - (c) Grease, oils, and many hydrocarbons.
 - (d) Leather.
 - (2) Synthetic Materials.
 - (a) PVC formulations (e.g., those plasticized with fatty acid esters).
 - (b) Certain polyurethanes (e.g., polyesters and some polyethers).
 - (c) Plastics that contain organic fillers of laminating materials.
 - (d) Paints and varnishes that contain susceptible constituents.
- b. Indirect Attack on Materials. Damage to fungus-resistant materials results from indirect attack when:
 - (1) Fungal growth on surface deposits of dust, grease, perspiration, and other contaminants (that find their way onto materiel during manufacture or accumulate during service) causes damage to the underlying material, even though that material may be resistant to direct attack.
 - (2) Metabolic waste products (i.e., organic acids) excreted by fungus cause corrosion of metals, etching of glass, or staining or degrading of plastics and other materials.
 - (3) The products of fungus on adjacent materials that are susceptible to direct attack come in contact with the resistant materials.

2.1.1.2 Physical Interference.

Physical interference can occur as follows:

- a. Electrical or Electronic Systems. Damage to electrical or electronic systems may result from either direct or indirect attack. Fungi can form undesirable electrical conducting paths across insulating materials, for example, or may adversely affect the electrical characteristics of critically adjusted electronic circuits.
- b. Optical Systems. Damage to optical systems results primarily from indirect attack. The fungus can adversely affect light transmission through the optical system, block delicate moving parts, etched glass, and change non-wetting surfaces to wetting surfaces with resulting loss in performance.

2.1.1.3 Health and Aesthetic Factors.

Fungus on materiel can cause physiological problems (e.g., allergies) or be so aesthetically unpleasant that the users will be reluctant to use the materiel.

2.1.2 Sequence Among Other Test Methods.

- a. General. Use the anticipated life cycle sequence of events as a general sequence guide (see Part One, paragraph 5.5).
- b. Unique to This Method. Because of the potentially unrepresentative combination of environmental effects, it is generally inappropriate to conduct this test on the same test sample previously subjected to salt fog, sand and dust, or humidity tests. However, if it is necessary, perform the fungus test before salt fog, or sand and

MIL-STD-810H
METHOD 508.8

dust tests. A heavy concentration of salt may affect the germinating fungus growth and sand and dust can provide nutrients, thus leading to a false indication of the bio-susceptibility of the test item. Be sure to decontaminate the test item prior to other testing (see Annex A).

2.2 Selecting Procedure Variations.

This Method has one procedure. Since the combination of temperature and humidity is critical to microbial growth, it is essential that these be maintained as specified in the procedure. However, other possible variations are described below.

2.2.1 Test Duration.

Twenty-eight days is the minimum test period to allow for fungus germination, breakdown of carbon-containing molecules, and degradation of material. Since indirect effects and physical interference are not likely to occur in the relatively short time frame of the fungus test, consider extension of the exposure period to 84 days if a greater degree of certainty (less risk) is required in determining the existence or effect of fungus growth.

2.2.2 Choice of Fungus.

The fungi used for this test are listed in Table 508.8-I. These organisms were selected because of their ability to degrade materials, their worldwide distribution, their stability, and their Biological Safety Level 1 classification. These organisms have, where possible, been identified with respect to the materials to which they are known to attack. Substitution of the species is not recommended.

- a. Because the test item may not be sterile before testing, other microorganisms may be present on the surfaces. When the test item is inoculated with the test fungi, both these and the other organisms will compete for available nutrients. It is not surprising to see organisms other than the test fungi growing on the test item at the end of the test. Hence, the need for trained personnel, e.g., mycologists, microbiologists, etc., to identify such situations.
- b. The spores chosen were identified as being prolific throughout the world and should remain as the base species for this test. The more dominant species will prevail in testing, therefore adding more species will likely only increase test costs without an increase in deterioration to material. You may add, but not substitute, additional species of fungus to those required in this test Method. However, if additional fungi are used (suggest only 1 or 2 other species), base their selection on prior knowledge of specific material deterioration. Consult trained personnel, e.g., mycologists, microbiologists, etc., to identify such situations.

3. INFORMATION REQUIRED.

3.1 Pretest.

The following information is required to conduct fungus tests adequately.

- a. General. Information listed in Part One, paragraphs 5.7 and 5.9; and Annex A, Task 405 of this Standard.
- b. Specific to This Method.
 - (1) Test item composition if known.
 - (2) Species to be used.
 - (3) Additional species to be added based upon known material composition.
 - (4) Duration of test.
 - (5) Test item photographs.
- c. Tailoring. Necessary variations in the basic test procedures to accommodate LCEP requirements.

MIL-STD-810H
METHOD 508.8**Table 508.8-I. TEST FUNGUS.**

FUNGUS	FUNGUS SOURCES IDENTIFICATION NO. ¹			MATERIALS AFFECTED
	NRRL ²	USDA ³	ATCC ⁴	
<i>Aspergillus flavus</i> (<i>Aflatoxin not produced</i>)	NRRL A5244	QM 380	ATCC 9643	Leathers, textiles, rubber. Electrical insulation, varnish, wax, packing materials, etc.
<i>Trichoderma virens</i>	NRRL 2314	QM 365	ATCC 9645	Degrades adhesives, cork, automotive components, electrical insulation, packing materials, plastics, polymers.
<i>Talaromyces pinophilus</i> (<i>pinofilum</i>) (formerly known as <i>Penicillium funiculosum</i>)	NRRL 3647	QM 474	ATCC 11797	Textiles, plastics, cotton fabric, polymers, automotive components such as gaskets, distributors, cables, hoses, PVC, airborne equipment such as breakers, solenoids, switches, remote transmission accessories
<i>Chaetomium globosum</i>	NRRL 1870	QM 459	ATCC 6205	Cellulose and any components containing paper and paper products such as packing materials, textiles, polymeric hydrocarbons and some synthetic polymeric materials
<i>Aspergillus brasiliensis</i> (formerly known as <i>niger</i>)	NRRL 3536	QM 386	ATCC 9642	Textiles, vinyl, conformal coatings, etches glass, insulation, leather, etc.; resistant to tanning salts

- Notes: 1. A catalogue number used by suppliers to identify various species within their collection.
2. US Department of Agriculture, Northern Regional Research Center, ARS Culture Collection, 1815 North University Street, Peoria, IL 61604.
3. US Department of Agriculture, Northern Regional Research Center, Quartermaster Collection, 1815 North University Street, Peoria, IL 61604.
4. American Type Culture Collection, 10801 University Blvd, Manassas, VA 20110-2209. (All suppliers may distribute the fungus in a lyophilized state or on agar slants. See USDA or ATCC site for any permit information needed for each State).

3.2 During Test.

Collect the following information during conduct of the test:

- a. General. Information listed in Part One, paragraph 5.10; and in Annex A, Tasks 405 and 406 of this Standard.
- b. Specific to This Method.
 - (1) Record of chamber temperature and humidity versus time conditions.
 - (2) Evidence of fungus growth on the cotton control strips at the 7-day check.

MIL-STD-810H
METHOD 508.8

- (3) Location of any fungal growth.

3.3 Post-Test.

The following post test data shall be included in the test report.

- a. General. Information listed in Part One, paragraphs 5.10 and 5.13; and in Annex A, Task 406 of this Standard.
- b. Specific to This Method.
 - (1) Evidence of fungus growth at the end of the test. If growth is found, identify the species if possible.
 - (2) Narrative description of growth, including colors, areas covered, growth patterns, density of growth, and photographs. (See Table 508.8-II.)
 - (3) Effect of fungus on performance or use:
 - (a) As received from the chamber.
 - (b) After removal of fungus, if appropriate.
 - (c) Physiological or aesthetic considerations.
 - (4) Observations to aid in failure analysis.
 - (5) Any deviation from the original test plan or test request.

4. TEST PROCESS.

4.1 Test Facility.

In addition to the standard requirements for test chambers, the following apply to chambers to be used for fungus tests.

4.1.1 Test Chamber.

Construct the chamber and accessories in a manner to prevent condensation from dripping on the test item. If required, filter-vent the chamber to the atmosphere to prevent the buildup of pressure and release of spores into the atmosphere.

4.1.2 Sensors.

Determine the relative humidity by employing either solid state sensors whose calibration is not affected by water condensation, or by an equivalent method such as fast-reacting wet-bulb/dry-bulb sensors or dew point indicators. Sensors that are sensitive to condensation, such as the lithium chloride type, are not recommended for tests with high relative humidity levels. A data collection system, including an appropriate recording device(s), separate from the chamber controllers is necessary to measure test volume conditions. If charts are used, use charts readable to within ± 2 °C (± 3.6 °F). If the wet-wick control method is approved for use, clean the wet bulb and tank and install a new wick before each test and at least every 30 days. Ensure the wick is as thin as realistically possible to facilitate evaporation (approximately 1/16 of an inch thick) consistent with maintaining a wet surface around the sensor. Use water in wet-wick systems that are of the same quality as that used to produce the humidity. When physically possible, visually examine the water bottle, wick, sensor, and other components making up relative humidity measuring systems at least once every 24 hours during the test to ensure they are functioning as desired.

4.1.3 Air Velocity.

Minimal airflow is recommended for this method. It has been found that velocities greater than 0.5 meters/second (98 feet/minute) retard the growth of fungus. If a wet bulb sensor is used, recommend an air velocity flowing across the wet bulb sensor of not less than 4.6 meters/second (900 feet/minute, or as otherwise specified in sensor response data), and ensure the wet wick is on the suction side of the fan to eliminate the effect of fan heat. Maintain the flow of air anywhere within the envelope of air surrounding the test item between 0.5 and 1.7 meters/second (98 to 335 feet/minute).

MIL-STD-810H
METHOD 508.8**4.1.4 Decontamination.**

Prior to testing, ensure the chamber is decontaminated in accordance with the guidance at Annex A.

4.2 Controls.

In addition to the information provided in Part One, paragraph 5, the following controls apply to this test.

4.2.1 Relative Humidity.

In addition to the requirements appropriate for Method 507.6 Humidity, and water purity as described in Part One, paragraph 5.16, determine the relative humidity by employing either solid state sensors whose calibration is not affected by water condensation or by an approved equivalent method such as fast-reacting wet bulb/dry bulb sensors. Do not use lithium chloride sensors because of their sensitivity to condensation.

- a. When the wet bulb control method is used, clean the wet bulb assembly and install a new wick for each test.
- b. In order to produce the evaporation necessary for sensor measurement of wet bulb temperature, ensure the air velocity across the wet bulb is not less than 4.6 m/s (900 ft/min).
- c. Because heat from fan motors may affect temperature readings, do not install wet and dry bulb sensors close to the discharge side of any local fan or blower used to create the requirement of paragraph 4.2.1b.

4.2.2 Circulation.

Maintain free circulation of air around the test item and keep the contact area of fixtures supporting the test item to a minimum.

4.2.3 Steam.

Do not inject steam directly into the test chamber working space where it may have an adverse effect on the test item and microbial activity.

4.2.4 Unless Otherwise Specified.

- a. Use only reagents that conform to the specifications of the Committee on Analytical Reagents of the American Chemical Society, where such specifications are available.
- b. Use water as described in Part One, paragraph 5.16. The intent is to not introduce contaminants or acidic/alkaline conditions that may affect the test results.

4.3 Test Interruption.

Test interruptions can result from two or more situations, one being from failure or malfunction of test chambers or associated test laboratory equipment. The second type of test interruption results from failure or malfunction of the test item itself during operational checks

4.3.1 Interruption Due To Chamber Malfunction.

- a. General. See Part One, paragraph 5.11, of this Standard.
- b. Specific to This Method. The fungus test, unlike other environmental tests, involves living organisms. If the test is interrupted, the fact that live organisms are involved must be considered. Observation of the control test strips should be performed weekly in order to determine corrective action.
 - (1) If the interruption occurs during the first seven days of the test, restart the test from the beginning with either a new or cleaned test item. If the interruption (such as a short power outage) does not produce drastic drops in humidity (less than 90 percent RH) and temperature (less than 28 °C (82 °F)), continue the test and add at least twelve hours to the final test time.
 - (2) If the interruption occurs between 8 and 25 days of testing, examine the control strips for evidence of fungus growth. The control strips should be observed weekly (through the glass windows or doors without opening the chamber), if possible. Labs should make a point of hanging at least one additional control in an easily visible location in the chambers. If the controls exhibit viable growth but there is no evidence of fungus growth on the test item, follow the guidance given below.

MIL-STD-810H
METHOD 508.8

- (3) If the interruption occurs after 25 days of testing, examine the test item for evidence of fungus growth. If the test item is bio-susceptible, there is no need for a retest. If the controls exhibit viable growth but there is no evidence of fungus growth on the test item, follow the guidance given below.
- (a) Lowered Temperature. A lowering of the test chamber temperature generally will retard fungus growth. If the relative humidity has been maintained, reestablish the test conditions and continue the test from the point where the temperature fell below the prescribed tolerances. If not, see paragraph 4.3.1.b(3)(c) below.
- (b) Elevated Temperature. Elevated temperatures may have a drastic effect on fungus growth. A complete re-initiation of the test may be required if one of the following conditions exist:
- (1) The temperature exceeds 40 °C (104 °F).
 - (2) The temperature exceeds 32 °C (90 °F) for 4 hours or more. A trained microbiologist can determine if the conditions warrant a restart.
 - (3) There is evidence of deterioration of the fungus growth on the control strips.
- Otherwise, reestablish test conditions and continue the test from the point of interruption.
- (c) Lowered Humidity. A complete retest may be required if one of the following conditions exist:
- (1) The relative humidity drops below 50 percent.
 - (2) The relative humidity drops below 70 percent for 4 hours or more.
 - (3) If the relative humidity drops between 70-90 percent for more than 24 hours, restart the test if there is evidence of fungal deterioration on the strips.
 - (4) There is any evidence of deterioration of the fungal colonies on the control strips. Consider use of newly prepared control strips after any test interruptions to aid in identifying new/continued growth.

Otherwise, reestablish test conditions and continue the test from the point of interruption.

4.3.2 Interruption Due To Test Item Operation Failure.

Failure of the test item(s) to function as required during operational checks during or following testing presents a situation with several possible options.

- a. The preferable option is to replace the test item with a “new” one and restart from Step 1.
- b. A second option is to replace / repair the failed or non-functioning component or assembly with one that functions as intended, and restart the entire test from Step 1.

4.4 Test Execution.

4.4.1 Cleaning.

Although it is preferable to use a new test item, a used item may be substituted. Cleaning (not sterilizing) can consist of wiping with a damp (water or other solution) cloth or following the test item cleaning instructions. If a solution other than water is used during the cleaning process, document the cleaning solution used in the test report. The cleaning shall be conducted at least 72 hours before test initiation. Prepare the test item in accordance with paragraph 4.5.1.

4.4.2 Miscellaneous.

- a. This Method is designed to provide optimal climatic conditions and all of the basic inorganic minerals needed for growth of the fungal species used in the test. The group of fungal species was chosen for its ability to attack a wide variety of materials commonly used in the construction of military materiel. Optional species may be added to the inoculum, if required (see paragraph 2.2.2).
- b. This test must be performed by trained personnel at laboratories specially equipped for microbiological work.
- c. The presence of moisture is essential for spore germination and growth. Generally, germination and growth will start when the relative humidity of the ambient air exceeds 70 percent. Development will become

MIL-STD-810H
METHOD 508.8

progressively more rapid as the humidity rises above this value, reaching a maximum in the 90 to less than 100 percent relative humidity range.

- d. The specified temperature of 30 ± 2 °C (86 ± 3.6 °F) is most conducive to the growth of the test fungi.
- e. Control items specified in paragraph 4.4.3.3 are designed to:
 - (1) Verify the viability of the fungus spores used in the inoculum.
 - (2) Establish the suitability of the chamber environment to support fungus growth.
- f. Although this procedure can provide information on the susceptibility of materials to fungus growth, the testing of materials and parts will not reveal potential fungus growth situations in materiel that can result due to the complexities involved in assemblages. Examples are induced conditions created by coatings and protective wrappings, deterioration of protective coatings due to bi-metallic reactions, and other situations that would not be encountered with the testing of components.

4.4.3 Preparation for Test.

4.4.3.1 Preparation for Mineral Salts Solution.

- a. Using clean apparatus, prepare the mineral salts solution to contain the following:

Potassium dihydrogen orthophosphate (KH ₂ PO ₄)	0.7 g
Potassium monohydrogen orthophosphate (K ₂ HPO ₄)	0.7 g
Magnesium sulfate heptahydrate (MgSO ₄ 7H ₂ O)	0.7 g
Ammonium nitrate (NH ₄ NO ₃)	1.0 g
Sodium chloride (NaCl)	0.005 g
Ferrous sulfate heptahydrate (FeSO ₄ 7H ₂ O)	0.002 g
Zinc sulfate heptahydrate (ZnSO ₄ 7H ₂ O)	0.002 g
Manganous sulfate monohydrate (MnSO ₄ H ₂ O)	0.001 g
Distilled water	1000 ml

- b. Ensure the pH of the mineral salts solution is between 6.0 and 6.5.
- c. Sterilize the solution for at least 30 minutes at 121 °C (250 °F) and 15 psi or according to the autoclave manufacturer's recommendations. To avoid precipitation of the solution during heating, separate the (KH₂PO₄) and (K₂HPO₄) from the rest of the solution. After autoclaving, combine the solutions and bring to final volume after cooling. If another sterilization technique is used in lieu of autoclaving (such as filter sterilization), state the procedure used in the test report.

4.4.3.2 Preparation of Mixed Spore Suspension.

NOTE - PRECAUTIONS: Although the exact strains of fungus specified for this test are not normally considered to present a serious hazard to humans, certain people may develop allergies or other reactions. Therefore, use standing operating procedures/good laboratory housekeeping techniques for safety. Also, use only personnel trained in microbiological techniques to conduct the tests.

- a. Use aseptic techniques to prepare the spore suspension containing the test fungi determined from paragraph 2.2.2. All hardware used should be sterile (as packaged or autoclaved) and the prep area should be disinfected. A bio-safety cabinet should be used to eliminate cross-contamination of spores or their release to the surrounding laboratory air.
- b. Maintain pure cultures of these fungi separately on an appropriate medium such as potato dextrose agar, but culture *Chaetomium globosum* on strips of filter paper overlaid on the surface of mineral salts agar. Prepare the mineral salts agar by dissolving 15.0g of agar in a liter of the mineral salts solution described in paragraph 4.4.3.1.

MIL-STD-810H
METHOD 508.8

NOTE: Do not keep the stock cultures for more than 6 months at 6 ± 4 °C (42 ± 7 °F). After that time, prepare subcultures and use them for the new stocks.

- c. Visually verify the purity of fungus cultures before the test.
- d. Make subcultures from the pure stock cultures and incubate them at 30 ± 2 °C (86 ± 3.6 °F) and greater than 90 but less than 100 percent relative humidity for 10 to 21 days. Most fungi will develop within 10 to 14 days and may show signs of deterioration after longer incubation.
- e. Prepare a spore suspension of each of the required test fungus by pouring into one subculture of each fungus 10 ml of a sterilized aqueous solution containing 0.05g per liter of a nontoxic wetting agent such as sodium dioctyl sulfosuccinate or sodium lauryl sulfate. There are several ways to aseptically harvest the necessary quantity of fungal spores. One way is to gently scrape the surface growth from the culture of the test organisms. Pour the spore charge into an appropriately sized sterile, Erlenmeyer flask containing sterilized water and glass beads (10 to 15 glass beads with a diameter of 4mm to 6mm has proven sufficient).
- f. Shake the flask vigorously to liberate the spores from the fruiting bodies. Filter as needed using sterile glass wool (i.e., Pyrex 3950 filtering fiber) in a sterile glass funnel to remove mycelium, but leave spores in solution. Centrifuge the filtered spore suspension and discard the supernatant liquid. Wash the pure suspensions with sterile water until the supernatant is clear.
- g. Dilute the final washed residue with the sterilized mineral-salts solution in such a manner that the resultant spore suspension contains $1,000,000 \pm 20$ percent spores per milliliter as determined with a counting chamber.
- h. Repeat this operation for each organism used in the test.
- i. Perform a viability check for each organism in accordance with paragraph 4.4.3.3.
- j. Blend appropriate volumes of the resultant spore suspensions to obtain the final mixed spore suspension.
- k. If a different technique is used to harvest the spores, state the procedure in the test report.

NOTE: Use a freshly prepared spore suspension. If not freshly prepared, it should be held at 6 ± 4 °C (42 ± 7 °F) for not more than 14 days.

4.4.3.3 Control Items.

Two types of control tests are required. Using the following procedures, verify the viability of the spore suspension and its preparation, as well as the suitability of the chamber environment.

- a. Viability of spore suspension.
 - (1) Before preparing the composite spore suspension, inoculate sterile potato dextrose (or another nutrient agar) plates with 0.2 to 0.3 ml of the spore suspension of each of the individual fungus species. Use separate agar plates for each species.
 - (2) Distribute the inoculum over the entire surface of the plate.
 - (3) Incubate the inoculated potato dextrose agar plates at 30 ± 2 °C (86 ± 3.6 °F) for 7 to 10 days.
 - (4) After the 7 to 10 day incubation period, check the fungus growth.

NOTE: The absence of copious growth of any of the test organisms over the entire surface in each container will invalidate the results of any tests using these spores.

- b. Verifying test chamber environment.

MIL-STD-810H
METHOD 508.8

- (1) To ensure proper conditions are present in the incubation chamber to promote fungus growth, install control strips into the chamber which have been soaked in the following prepared solution:

Potassium dihydrogen orthophosphate (KH ₂ PO ₄)	0.1 g
Ammonium nitrate (NH ₄ N0 ₃)	0.1 g
Magnesium sulfate heptahydrate (MgSO ₄ 7H ₂ O)	0.025 g
Yeast extract	0.05 g
Distilled water to a total volume of	100 ml
A nontoxic wetting agent such as sodium dioctyl sulfosuccinate or sodium lauryl sulfate	0.005 g
Glycerol	10.0 g

Use HCl and NaOH to adjust the final solution pH to 5.3 (this solution is not sterilized but used immediately in preparation of the control strips).

- (2) Prepare control strips from unbleached, plain weave, 100 percent cotton cloth, such as MIL-T-43566, (Type I, Class I only, commercially available). Sterilize the control strips prior to soaking in the above solution. After the strips are thoroughly wetted, remove the excess liquid from the strips and hang them to dry. (Use only strips devoid of fungicides, water repellents and sizing additives. To aid in removing any possible treatment materials, recommend boiling in distilled water (not required if using MIL-T-43566, Type 1, Class I)).
- (3) Place the strips vertically within the chamber close to and bracketing the test items to ensure the test strips and test items experience the same test environment. The width of the strips should be such that they can be easily viewed for growth during testing (recommend at least 1.9 cm (0.75 inches width)).

4.5 Test Procedure.

4.5.1 Preparation for Incubation.

- Step 1 Assure the condition of the items to be tested is similar to their condition as delivered by the manufacturer or customer for use, or as otherwise specified. Accomplish any cleaning of the test item at least 72 hours before the beginning of the fungus test to allow for evaporation of volatile materials.
- Step 2 Install the test item in the chamber or cabinet on suitable fixtures, and remove any covers. (see note and Step 5 below).
- Step 3 Hold the test item in the test chamber at 30 ± 2 °C (86 ± 3.6 °F) and a RH of at least 90 percent but less than 100 percent for at least four hours immediately before inoculation.
- Step 4 Inoculate the test item and the cotton fabric chamber control items with the mixed fungus spore suspension by spraying the suspension on the control items and on and into the test item(s) (if not permanently or hermetically sealed) in the form of a fine mist from an atomizer or nebulizer. Ensure personnel with appropriate knowledge of the test item are available to aid in exposing its interior surfaces for inoculation.

NOTE: In spraying the test and control items with composite spore suspension, cover all external and internal surfaces that are exposed during use or maintenance. If the surfaces are non-wetting, spray until drops begin to form on them.

- Step 5 In order for air to penetrate, replace the covers of the test items without tightening the fasteners.
- Step 6 Start incubation (paragraph 4.5.2) immediately following the inoculation.

MIL-STD-810H
METHOD 508.8

4.5.2 Incubation of the Test Item.

- Step 1 Except as noted in Step 2 below, incubate the test items at constant temperature and humidity conditions of 30 ± 2 °C (86 ± 3.6 °F) and a relative humidity of at least 90 percent but less than 100 percent for the test duration (28 days, minimum).
- Step 2 Inspect the growth on the control cotton strips after 7 days to verify the environmental conditions in the chamber are suitable for growth. Verify that at least 90 percent of the surface area of each test strip located at the level of the test item is covered by fungus (fungus may not have developed color. At 14 days, fungus can be readily seen and 90% coverage of strip should be verified). If it is not, repeat the entire test with the adjustments of the chamber required to produce conditions suitable for growth or check spore viability. Leave the control strips in the chamber for the duration of the test and visually check the growth weekly (observe through window).
- Step 3 If the cotton strips show satisfactory fungus growth after 7 days, continue the test for the required period from the time of inoculation as specified in the test plan. If there is no increase in fungus growth on the cotton strips at the second inspection interval (day 14) of the test as compared to the initial 7-day results, the test is invalid and see paragraph 4.3.1 for guidance.
- Step 4 If the end of designated incubation time falls on a holiday or non-work day due to a scheduling issue or extension of the test due to environmental parameter outliers, extend the test time as needed and note all deviations in the final report.

4.5.3 Inspection.

At the end of the incubation period inspect the test item immediately and if possible, within the chamber with the circulation fans off. If the item is removed from the chamber to conduct the inspection, recommend completing the inspection within 4 hours. If the inspection takes longer than 4 hours, return the item to the chamber or a similar humid environment for a minimum of 2 hours prior to completing inspection. Record the results of the inspection.

4.5.4 Operation/Use.

(To be conducted only if required.) If operation of the test item is required (e.g., electrical materiel), conduct the operation in the inspection period as specified in paragraph 4.5.3. Ensure personnel with appropriate knowledge of the test item are available to aid in exposing its interior surfaces for inspection and in making operation and use decisions. Disturbance of any fungus growth must be kept to a minimum during the operational checkout. If the test item fails to operate as intended, see paragraph 5, and follow the guidance in paragraph 4.3.2.

WARNING: Because of the potential hazardous nature of this test, operation/use by personnel with appropriate knowledge of the test item will be performed under the guidance of technically-qualified personnel (e.g., microbiologists). Appropriate personal protective equipment (PPE) must be worn.

4.6 Decontamination.

See Annex A.

5. ANALYSIS OF RESULTS.

In addition to the guidance provided in Part One, paragraphs 5.14 and 5.17, the following information is provided to assist in the evaluation of the test results. Apply any data relative to failure of a test item to meet the requirements of the materiel specifications to the test analysis, and consider related information such as:

- a. Any fungal growth on the test item must be analyzed to determine the species.
- b. Any fungal growth on the test item material(s), whether from the inoculum or other sources, must be evaluated by qualified personnel for:
 - (1) The extent of growth on susceptible components or materials. Use Table 508.8-II as a guide for this evaluation, but any growth must be completely described.

MIL-STD-810H
METHOD 508.8

- (2) The immediate effect such as discoloration or other visual degradation that the growth has on the physical characteristics of the materiel.
 - (3) The long-range effect that the growth could have on the materiel (possible storage issues if degradation is noted).
- c. Evaluate human factors effects (paragraph 2.1.1.3).
 - d. Cleaning solution used if other than water.

Table 508.8-II. Evaluation scheme for visible effects.

AMOUNT OF GROWTH	RATING	COMMENTS
None	0	Substrate is devoid of microbial growth.
Trace	1	Scattered, sparse or very restricted microbial growth.
Light	2	Intermittent infestations or loosely spread microbial colonies on substrate surface. Includes continuous filamentous growth extending over the entire surface, but underlying surfaces are still visible.
Medium	3	Substantial amount of microbial growth. Substrate may exhibit visible structural change.
Heavy	4	Massive microbial growth.

6. REFERENCE/RELATED DOCUMENTS.

6.1 Referenced Documents.

- a. AR 70-38, Research, Development, Test and Evaluation of Materiel for Extreme Climatic Conditions.
- b. STANAG 4370 Environmental Testing.
- c. Allied Environmental Conditions and Test Publication (AECTP) 300 (under STANAG 4370), Climatic Environmental Testing, Method 308.
- d. MIL-HDBK-454, General Guidelines for Electronic Equipment

6.2 Related Documents.

- a. Specifications of the Committee on Analytical Reagents of the American Chemical Society.
- b. ASTM 1193 Standard Specification for Reagent Water.
- c. Egbert, Herbert W. "The History and Rationale of MIL-STD-810 (Edition 2)", January 2010; Institute of Environmental Sciences and Technology, Arlington Place One, 2340 S. Arlington Heights Road, Suite 100, Arlington Heights, IL 60005-4516.

(Copies of Department of Defense Specifications, Standards, and Handbooks, and International Standardization Agreements are available online at <https://assist.dla.mil>.)

MIL-STD-810H
METHOD 508.8

Requests for other defense-related technical publications may be directed to the Defense Technical Information Center (DTIC), ATTN: DTIC-BR, Suite 0944, 8725 John J. Kingman Road, Fort Belvoir VA 22060-6218, 1-800-225-3842 (Assistance--selection 3, option 2), <http://www.dtic.mil/dtic/>; and the National Technical Information Service (NTIS), Springfield VA 22161, 1-800-553-NTIS (6847), <http://www.ntis.gov/>.

MIL-STD-810H
METHOD 508.8

(This page is intentionally blank.)

MIL-STD-810H
METHOD 508.8 ANNEX A**METHOD 508.8, ANNEX A****DECONTAMINATION OF TEST EQUIPMENT AND TEST ITEMS AFTER EXPOSURE TO FUNGUS**

1. Decontamination of test equipment, materials, and test items that have been subjected to a fungus test is paramount when the test items are to be sent back to the users, manufacturer, or material management office for further evaluation or reuse. Many test items are too expensive to scrap and must be decontaminated.
2. Decontamination and disinfection of the test chamber.
 - a. Initially, good housekeeping procedures should be followed for all testing, especially those tests involving live cultures.
 - b. Prior to any testing, the climatic chamber should be thoroughly cleaned inside with a hot, soapy water (or Lysol[®]-type, parachlorometaxynol or other microbial decontaminant cleaner) solution.
 - c. With no items in chamber, apply high heat (at least 60 °C (140 °F)) and humidity (greater than 90 percent RH) for at least 2 hours. Dry the chamber at 60 °C (140 °F) with no humidity prior to cooling the chamber to ambient. Place the test items in the chamber for fungus testing.
 - d. After testing is complete and the items have been examined/pictures taken, the items and the chamber can be initially sterilized with high heat as above and at least 90 percent relative humidity for at least 2 hours. The humidity keeps the surfaces wet until the spores are destroyed.

NOTE: The test items must be able to withstand the high temperature chosen for initial sterilization without damage. Check the test item user's manual for the storage temperature before proceeding. If the heat is less than 40 °C (104 °F), a longer decontamination time will be needed (up to several days).

Alternatively, the chamber can be washed with a sodium or calcium hypochlorite solution at 5000 ppm concentration (wear appropriate personal protective equipment (PPE) when using any chemical solutions). A phenolic disinfectant spray can also be used and a Lysol[®]-type solution will also help control microbial growth. Copious flushing with water to rinse the chamber is needed to limit the chlorine contact on the metal surfaces.

- e. If the test items are washable, follow the instructions for each item and launder in a machine, if possible.
- f. If the items cannot be washed with a solution, wipe with a damp cloth that has been sprayed with a phenolic solution (disinfectant spray) and label the items appropriately with precautions on handling items that have been subjected to fungus testing. Personnel trained in microbiological techniques and who conduct these tests should have general operating procedures in place for handling fungus cultures and test items after exposure.
- g. Perform chamber disinfection after each fungus test. This will ensure a clean test chamber is used, and will help eliminate fungus spores from contaminating the next test. Be sure to disinfect all surfaces and hangers used during testing as well.

MIL-STD-810H
METHOD 508.8 ANNEX A

(This page is intentionally blank.)

MIL-STD-810H
METHOD 508.8 ANNEX B

METHOD 508.8, ANNEX B
FUNGUS-INERT MATERIALS
(See paragraph 6.1, reference d)

NOTE: Although the basic (documented) resistance of materials to fungal growth shown below is helpful in the design of new materiel, it is unreliable in determining the fungal susceptibility of complex materials, and the use of testing by analysis is discouraged. The combination of materials, the physical structure of combined materials, and the possible contamination of resistant materials during manufacture is beyond the purview of superficial analysis, and necessitates laboratory or natural environment tests to verify the resistance of the assembled materiel to fungal growth. Caution: The below Table is not a comprehensive list and does not necessarily reflect modern day formulations of materials.

Table 508.8B-I. Fungi susceptibility of materials.

Group I - Fungus-inert materials (Fungus-inert in all modified states and grades)	
Acrylics Acrylonitrile-styrene Acrylonitrile-vinyl-chloride copolymer Asbestos Ceramics Chlorinated polyester Fluorinated ethylenepropylene copolymer (FEP) Glass Metals Mica Plastic laminates: Silicone-glass fiber Phenolic-nylon fiber Diallyl phthalate Polyacrylonitrile	Polyamide ¹ Polycarbonate Polyester-glass fiber laminates Polyethylene, high density (above 0.940) Polyethylene terephthalate Polyimide Polymonochlorotrifluoroethylene Polypropylene Polystyrene Polysulfone Polytetrafluoroethylene Polyvinylidene Chloride Silicone resin Siloxane-polyolefin polymer Siloxane polystyrene
Group II - Fungus nutrient materials (May require treatment to attain fungus resistance)	
ABS (acrylonitrile-butadiene-styrene) Acetal resins Cellulose acetate Cellulose acetate butyrate Epoxy-glass fiber laminates Epoxy-resin Lubricants Melamine-formaldehyde Organic polysulphides Phenol-formaldehyde	Polydichlorostyrene Polyethylene, low & medium density (0.940 and below) Polymethyl methacrylate Polyurethane (ester types are particularly susceptible) Polyricinoleates Polyvinyl chloride Polyvinyl chloride-acetate Polyvinyl fluoride Rubber, natural and synthetic Urea-formaldehyde

NOTE: 1. Literature shows that, under certain conditions, polyamides may be attacked by selective micro-organisms. However, for military applications, they are considered Group I.

MIL-STD-810H
METHOD 508.8 ANNEX B

(This page is intentionally blank.)

MIL-STD-810H
METHOD 509.7

METHOD 509.7
SALT FOG
CONTENTS

<u>Paragraph</u>	<u>Page</u>
1. SCOPE	1
1.1 PURPOSE	1
1.2 APPLICATION	1
1.3 LIMITATIONS	1
2. TAILORING GUIDANCE	1
2.1 SELECTING THE SALT FOG METHOD	1
2.1.1 EFFECTS OF CORROSIVE ENVIRONMENTS	1
2.1.1.1 CORROSION EFFECTS	2
2.1.1.2 ELECTRICAL EFFECTS	2
2.1.1.3 PHYSICAL EFFECTS	2
2.1.2 EFFECTS OF CORROSIVE ENVIRONMENTS	2
2.2 SELECTING PROCEDURE VARIATIONS	2
2.2.1 SALT SOLUTION	2
2.2.2 TEST ITEM CONFIGURATION	2
2.2.3 DURATION.....	2
2.2.4 TEMPERATURE	3
2.2.5 AIR CIRCULATION.....	3
2.2.6 FALLOUT RATE	3
2.2.7 DRYOUT RATE	3
3. INFORMATION REQUIRED.....	3
3.1 PRETEST.....	3
3.2 DURING TEST.....	3
3.3 POST-TEST	3
4. TEST PROCESS	4
4.1 TEST FACILITY	4
4.1.1 TEST CHAMBER.....	4
4.1.2 SALT SOLUTION RESERVOIR	4
4.1.3 SALT SOLUTION INJECTION SYSTEM	4
4.1.4 SALT FOG COLLECTION RECEPTACLES	5
4.2 CONTROLS	5
4.3 TEST INTERRUPTION	5
4.3.1 TEST INTERRUPTION. DUE TO CHAMBER MALFUNCTION	5
4.3.2 TEST INTERRUPTION DUE TO TEST ITEM OPERATION FAILURE.....	6
4.4 TEST SETUP.....	6
4.5 TEST EXECUTION	6
4.5.1 PREPARATION FOR TEST.....	6
4.5.1.1 PRELIMINARY STEPS	6
4.5.1.2 PRETEST STANDARD AMBIENT CHECKOUT.....	8
4.5.2 PROCEDURE	9
5. ANALYSIS OF RESULTS	9

MIL-STD-810H
METHOD 509.7**CONTENTS - Continued**

<u>Paragraph</u>	<u>Page</u>
6. REFERENCE/RELATED DOCUMENTS	10
6.1 REFERENCED DOCUMENTS.....	10
6.2 RELATED DOCUMENTS.....	11

TABLES

TABLE 509.7-I. AIR PRESSURE AND PREHEAT TEMPERATURE REQUIREMENTS FOR OPERATION AT 35 °C (95 °F).....	5
TABLE 509.7-II. TEMPERATURE VERSUS DENSITY DATA.....	8

FIGURES

FIGURE 509.7-1 LOCATION OF SALT SOLUTION FILTER.....	4
FIGURE 509.7-2 SALT SOLUTION FILTER.....	5
FIGURE 509.7-3 VARIATIONS OF DENSITY OF SALT (NaCl) SOLUTION WITH TEMPERATURE.....	7

MIL-STD-810H
METHOD 509.7**METHOD 509.7**
SALT FOG

NOTE: Tailoring is essential. Select methods, procedures, and parameter levels based on the tailoring process described in Part One, paragraph 4.2.2, and Annex C. Apply the general guidelines for laboratory test methods described in Part One, paragraph 5 of this standard.

1. SCOPE.**1.1 Purpose.**

The salt fog Method is performed to determine the effectiveness of protective coatings and finishes on materials. It may also be applied to determine the effects of salt deposits on the physical and electrical aspects of materiel.

1.2 Application.

Use this Method for screening purposes only to evaluate the effectiveness and quality of protective coatings and finishes on materiel and material coupons, and to locate potential problem areas, quality control deficiencies, design flaws, etc., in a relatively short period of time. Although not representative of the natural environment (see paragraph 1.3b), this test has been used to provide an indication of potential problem areas associated with the salt (marine) environment. In general, only apply this Method to materiel that will experience significant exposure (as opposed to infrequent or irregular) to high levels of salt in the atmosphere. Use of this Method to evaluate material coupons is not intended to be conducted in lieu of full assemblage testing.

1.3 Limitations.

This Method does not attempt to duplicate the complex environment but, rather, it provides a generally stressful situation that may reveal potential problem areas in materiel. Testing in the natural environment, whenever practical, may provide more valuable results. Specifically, this Method does not address:

- a. There is no relationship between this test and any real world exposure duration. The test is not intended to duplicate the effects of a marine atmosphere due to variations in chemical composition and concentrations of the various marine and other corrosive environments.
- b. It has not been demonstrated that a direct relationship exists between salt fog corrosion and corrosion due to other media.
- c. It has not been demonstrated that withstanding the effects of this test guarantees materiel will survive under all corrosive conditions. For acidic atmosphere tests, see Method 518.2. Consult ASTM G85, "Standard Practice for Modified Salt Spray (Fog) Testing" (paragraph 6.1, reference a) for information on introducing a sulfur dioxide environment. Caution: Introducing sulfur dioxide in the salt fog chamber may contaminate the chamber for future salt fog tests.
- d. This test has proven to be generally unreliable for predicting the service life of different materials or coatings.
- e. This test is not a substitute for evaluating corrosion caused by humidity and fungus because their effects differ from salt fog effects and the tests are not interchangeable.

2. TAILORING GUIDANCE.**2.1 Selecting the Salt Fog Method.**

After examining requirements documents and applying the tailoring process in Part One of this standard to determine where atmospheric corrosion is anticipated in the life cycle of materiel, use the following to confirm the need for this Method and to place it in sequence with other methods.

2.1.1 Effects of Corrosive Environments.

Salt is one of the most pervasive chemical compounds in the world. It is found in the oceans and seas, the atmosphere, ground surfaces, and lakes and rivers. It is impossible to avoid exposure to salt. The worst effects occur, in general, in coastal regions. The effects of exposure of materiel to an environment where there is a corrosive atmosphere can be divided into three broad categories: corrosion effects, electrical effects, and physical effects. Consider the following typical problems to help determine if this Method is appropriate for the materiel being tested. This list is not intended to be all-inclusive.

MIL-STD-810H
METHOD 509.7**2.1.1.1 Corrosion Effects.**

- a. Corrosion due to electrochemical reaction.
- b. Accelerated stress corrosion.
- c. Formation of acidic/alkaline solutions following salt ionization in water.

2.1.1.2 Electrical Effects.

- a. Impairment of electrical materiel due to salt deposits.
- b. Production of conductive coatings.
- c. Corrosion of insulating materials and metals.

2.1.1.3 Physical Effects.

- a. Clogging or binding of moving parts of mechanical components and assemblies.
- b. Blistering of paint as a result of electrolysis.

2.1.2 Sequence Among Other Methods.

- a. General. Use the anticipated life cycle sequence of events as a general sequence guide (see Part One, paragraph 5.5).
- b. Unique to this Method. If the same test item is to be used for additional testing, it is imperative that the test item be thoroughly cleaned following the Salt Fog test. Salt deposits can interfere with the effects of other tests. In most cases recommend the salt fog test be conducted after the other climatic tests. It is generally inappropriate to conduct the salt fog, fungus and humidity tests on the same test sample because the cumulative of effects from the three environments may be unrealistic. However, if it is necessary to do so, perform the salt fog test following the fungus and humidity tests. Although generally inappropriate, if sand and dust testing is required on the same test item, perform it following salt fog testing. Recommend conducting the sequence of testing in accordance with the LCEP.

2.2 Selecting Procedure Variations.

This Method has one procedure. Possible variations are described below.

2.2.1 Salt Solution.

Unless otherwise identified, use a 5 ± 1 percent salt solution concentration (paragraph 6.1, reference b.). Use water as described in Part One, paragraph 5.16. The intent is to not introduce contaminants or acidic/alkaline conditions that may affect the test results. (See paragraph 4.5.1.1.b.)

2.2.2 Test Item Configuration.

The configuration and orientation of the test item during the exposure period of the salt fog test is an important factor in determining the effect of the environment on the test item. Unless otherwise specified, configure the test item and orient it as would be expected during its storage, shipment, or use. The listing below offers the most likely configurations that materiel would assume when exposed to a corrosive atmosphere. For test purposes, choose the most severe/critical configuration.

- a. In a shipping/storage container or transit case.
- b. Outside of its shipping/storage container but provided with an effective environmental control system that partly excludes the salt fog environment.
- c. Outside of its shipping/storage container and set up in its normal operating mode.
- d. Modified with kits for special applications or to compensate for mating components that are normally present, but are not used for this specific test.

2.2.3 Duration.

Experience has shown that alternating 24-hour periods of salt fog exposure and drying conditions for a minimum of four 24-hour periods (two wet and two dry), provides more realistic exposure and a higher damage potential than does continuous exposure to a salt atmosphere (paragraph 6.1, reference b). If this option is not acceptable (e.g., security issues, LCEP information, or commodity requirements), perform 48 hours of exposure followed by 48 hours of drying. Increase the number of cycles to provide a higher degree of confidence in the ability of the materials involved to withstand a corrosive environment.

MIL-STD-810H
METHOD 509.7**2.2.4 Temperature.**

Maintain the temperature in the chamber at 35 ± 2 °C (95 ± 3.6 °F). This temperature has been historically accepted and is not intended to simulate actual exposure situations. Other temperatures may be used if appropriate.

2.2.5 Air Circulation.

Ensure the air velocity in test chambers is minimal (essentially zero).

2.2.6 Fallout Rate.

The collection of fog shall be such that each solution receptacle collects 1 to 3 ml of solution per hour for each 80 cm² of horizontal collecting area based on at least a 16 hr period. A minimum of two salt fog collection receptacles shall be located at the perimeter of the test item one at the point nearest to the nozzle and another at the point farthest from the nozzle. Position the receptacles such that they are not shielded by the test item and will not collect drops of solution from the test item or other sources. If using multiple nozzles or towers, the same principles apply.

2.2.7 Dryout Rate.

If corrosion levels from test to test are to be compared, and accepting that the rate of corrosion is much higher during the transition from wet to dry, it is critical to closely control the rate of drying.

3. INFORMATION REQUIRED.**3.1 Pretest.**

The following information is required to conduct salt fog tests adequately.

- a. General. Information listed in Part One, paragraphs 5.7 and 5.9, and Annex A, Task 405 of this standard.
- b. Specific to this Method.
 - (1) Areas of the test item visually and functionally examined and an explanation of their inclusion or exclusion.
 - (2) Salt concentration if other than 5 percent.
 - (3) Resistivity and type of initial water.
 - (4) The appropriate exposure option, i.e., 24/24/24/24-hrs, or 48/48-hrs (see paragraph 2.2.3).
- c. Tailoring. Necessary variations in the basic test procedures to accommodate environments identified in the LCEP.

3.2 During Test.

Collect the following information during conduct of the test:

- a. General. Information listed in Part One, paragraph 5.10, and in Annex A, Tasks 405 and 406 of this standard.
- b. Specific to this Method.
 - (1) Record of chamber temperature versus time conditions.
 - (2) Salt fog fallout quantities per unit of time (paragraph 4.1.4).
 - (3) Salt fog pH (paragraph 4.5.1.1b).

3.3 Post-Test.

The following post test data shall be included in the test report.

- a. General. Information listed in Part One, paragraph 5.13, and in Annex A, Task 406 of this standard.
- b. Specific to this Method.
 - (1) Areas of the test item visually and functionally examined and an explanation of their inclusion or exclusion.
 - (2) Test variables:
 - (a) Salt solution pH.
 - (b) Salt solution fallout rate (ml/cm²/hr).
 - (3) Results of examination for corrosion, electrical, and physical effects.
 - (4) Observations to aid in failure analysis (to include photographs).
 - (5) Any deviation from the approved test plan.

MIL-STD-810H
METHOD 509.7

4. TEST PROCESS.

4.1 Test Facility.

Ensure the apparatus used in performing the salt fog test includes the following.

4.1.1 Test Chamber.

Use supporting racks that do not affect the characteristics of the salt fog mist. No part of the test setup that contacts the test item may induce electrolytic corrosion. Do not allow condensation to drip on the test item. Do not return any liquid that comes in contact with either the chamber or the test item to the salt solution reservoir. Vent the exposure area to prevent pressure buildup. Ensure the test chamber has a waste collection system so that all waste material can be analyzed prior to disposal. Dispose of any material determined to be hazardous waste in accordance with local, state and federal regulations.

4.1.2 Salt Solution Reservoir.

Ensure the salt solution reservoir is made of material that is non-reactive with the salt solution, e.g., glass, hard rubber, or plastic.

4.1.3 Salt Solution Injection System.

Filter the salt solution (Figures 509.7-1 and -2) and inject it into the test chamber with atomizers that produce a finely divided, wet, dense fog. Use atomizing nozzles and a piping system made of material that is non-reactive to the salt solution. Do not let salt buildup clog the nozzles. Suitable atomization has been obtained in chambers having a volume of less than 0.34 m^3 (12 ft^3) under the following conditions:

- Nozzle pressure as low as practical to produce fog at the required rate.
- Orifices between 0.5 and 0.76 mm (0.02 and 0.03 in.) in diameter.
- Atomization of approximately 2.8 liters of salt solution per 0.28 m^3 (10 ft^3) of chamber volume per 24 hours.

When chambers with a volume considerably in excess of 0.34 m^3 (12 ft^3) are used, the conditions specified may require modification.

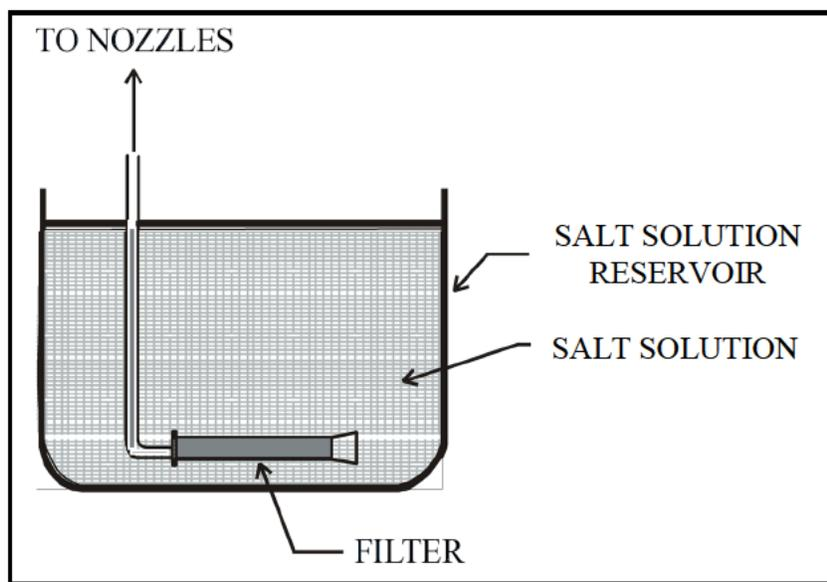


Figure 509.7-1. Location of salt solution filter.

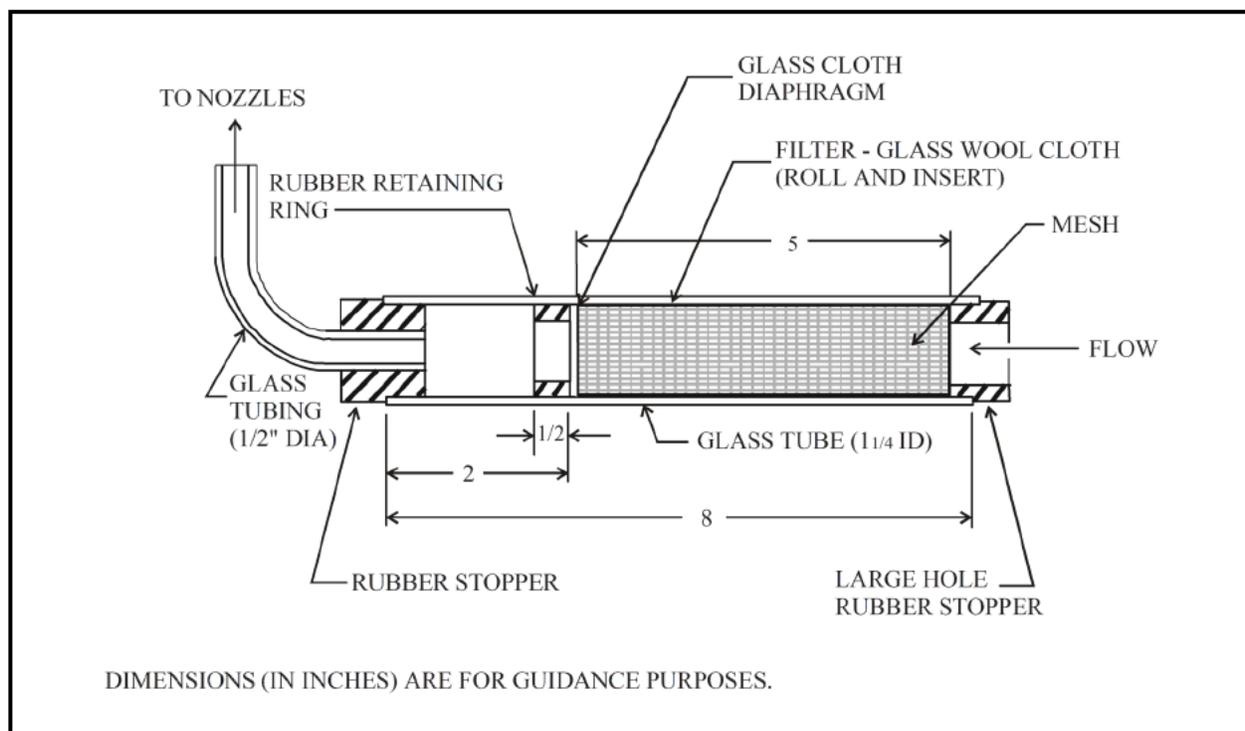
MIL-STD-810H
METHOD 509.7

Figure 509.7-2. Salt solution filter.

4.1.4 Salt Fog Collection Receptacles.

Suitable collecting devices are glass or plastic funnels each with a diameter of 10 cm (3.94 in.). The funnel stems can be inserted into graduated cylinders (100 ml volume) or crystallizing dishes with same diameter can be used.

4.2 Controls.

Preheat the oil-free and dirt-free compressed air used to produce the atomized solution (to offset the cooling effects of expansion to atmospheric pressure) (see Table 509.7-I).

Table 509.7-I. Air pressure and preheat temperature requirements for operation at 35 °C (95 °F).

Air Pressure (kPa)	83	96	110	124
Preheat temperature (°C) (before atomizing)	46	47	48	49

4.3 Test Interruption.

Test interruptions can result from two or more situations, one being from failure or malfunction of test chambers or associated test laboratory equipment. The second type of test interruption results from failure or malfunction of the test item itself during required or optional performance checks.

4.3.1 Interruption Due to Chamber Malfunction.

- a. General. See Part One, paragraph 5.11 of this standard.
- b. Specific to this Method.
 - (1) Undertest interruption. If an unscheduled test interruption occurs that causes the test conditions to exceed allowable tolerances toward standard ambient conditions, give the test item a complete visual examination and develop a technical evaluation of the impact of the interruption on the test results. Restart the test at the point of interruption and re-stabilize the test item at the test conditions.

MIL-STD-810H
METHOD 509.7

- (2) Overtest interruption. If an unscheduled test interruption occurs that causes the test conditions to exceed allowable tolerances away from standard ambient conditions, stabilize the test conditions to within tolerances and hold them at that level until a complete visual examination and technical evaluation can be made to determine the impact of the interruption on test results. If the visual examination or technical evaluation results in a conclusion that the test interruption did not adversely affect the final test results, or if the effects of the interruption can be nullified with confidence, restabilize the pre-interruption conditions and continue the test from the point where the test tolerances were exceeded.

4.3.2 Interruption Due to Test Item Operation Failure.

Failure of the test item(s) to function as required during mandatory or optional performance checks during testing presents a situation with several possible options.

- a. The preferable option is to replace the test item with a “new” one and restart from Step 1.
- b. A second option is to replace / repair the failed or non-functioning component or assembly with one that functions as intended, and restart the entire test from Step 1.

NOTE: When evaluating failure interruptions, consider prior testing on the same test item and consequences of such.

4.4 Test Setup.

- a. General. See Part One, paragraph 5.8.
- b. Unique to this Method. Ensure the fallout collection containers are situated in the chamber such that they will not collect fluids dripping from the test item.

4.5 Test Execution.

The following steps, alone or in combination, provide the basis for collecting necessary information concerning the test item in a salt fog environment.

4.5.1 Preparation for Test.

4.5.1.1 Preliminary Steps.

Before starting the test, determine the test details (e.g., procedure variations, test item configuration, cycles, durations, parameter levels for storage/operation, etc.) from the test plan. (See paragraph 3.1 above.)

- a. Handling and configuration.
 - (1) Handle the test item as little as possible. Prepare the test item for testing immediately before exposure. Unless otherwise specified, ensure the test item surfaces are free of surface contamination such as oil, grease, or dirt that could cause a water break. Do not use corrosive solvents, solvents that deposit either corrosive or protective films, or abrasives other than a paste of pure magnesium oxide in any cleaning methods.
 - (2) Configure the test item as specified in the test plan and insert it into the test chamber.
- b. Preparation of salt solution. For this test, use sodium chloride containing (on a dry basis) not more than 0.1 percent sodium iodide and not more than 0.5 percent total impurities. Do not use sodium chloride containing anti-caking agents because such agents may act as corrosion inhibitors. Unless otherwise specified, prepare a 5 ± 1 percent solution by dissolving 5 parts by weight of salt in 95 parts by weight of water. Adjust to and maintain the solution at a specific gravity (Figure 509.7-3 and Table 509.7-II) by using the measured temperature and density of the salt solution. If necessary, add sodium tetraborate (borax) to the salt solution as a pH stabilization agent in a ratio not to exceed 0.7g sodium tetraborate to 75 liters of salt solution. Maintain the pH of the salt solution, as collected as fallout in the exposure chamber, between 6.5 and 7.2 with the solution temperature at $+35 \pm 2$ °C (95 ± 4 °F). To adjust the pH, use only diluted chemically pure hydrochloric acid or chemically pure sodium hydroxide. Make the pH measurement either electrometrically or colorimetrically.
- c. Chamber operation verification. Unless the chamber has been used within five days or the nozzle becomes clogged, immediately before the test and with the exposure chamber empty, adjust all test parameters to those required for the test. Maintain these conditions for at least one 24-hour period or until proper operation and salt fog collection can be verified. To verify the chamber is operating properly, measure the salt fog fallout after 24 hours. Monitor and record the test chamber temperature.

MIL-STD-810H
METHOD 509.7

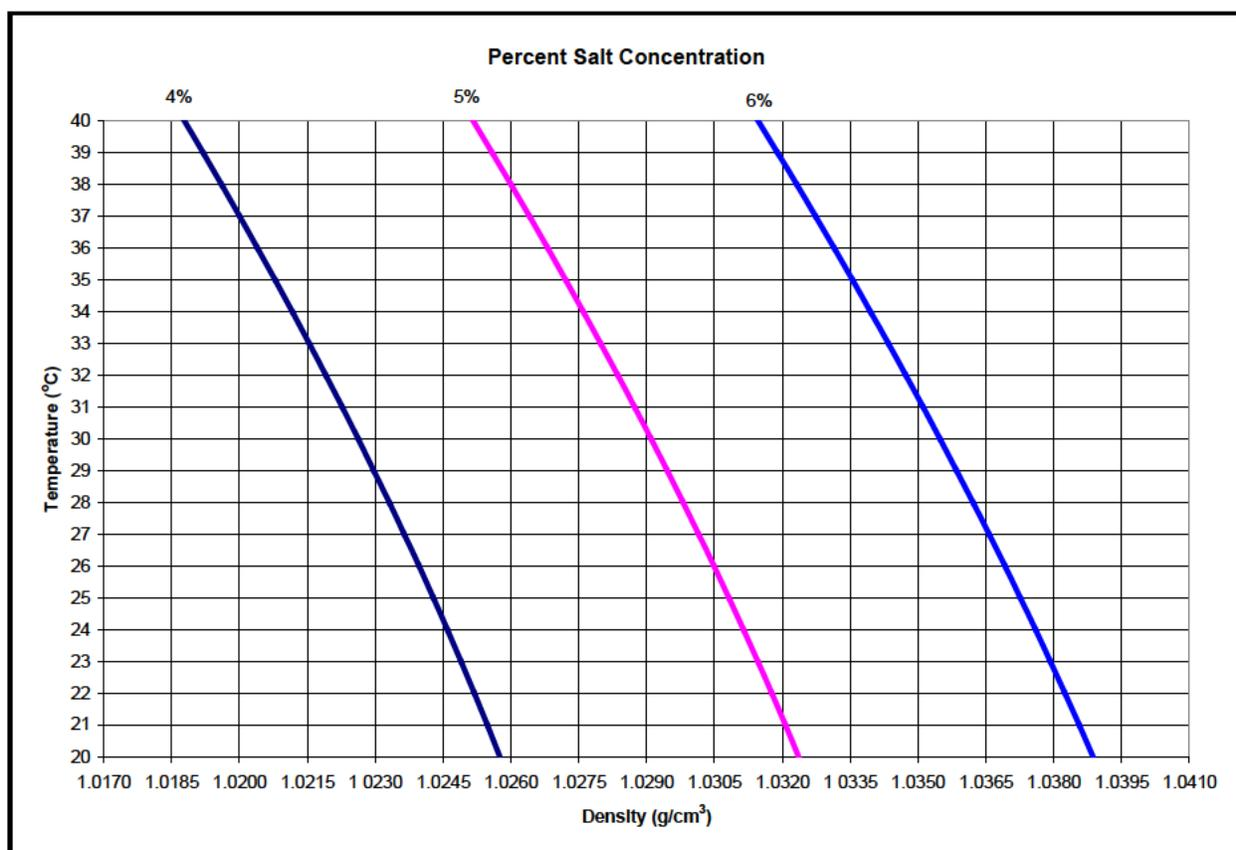


Figure 509.7-3. Variations of density of salt (NaCl) solution with temperature.¹

¹ Data derived from equation information found in paragraph 6.1, reference c.

MIL-STD-810H
METHOD 509.7**Table 509.7-II. Temperature versus density data. ²**

Temperature °C (°F)	Density g/cm ³		
	4-percent Salt Concentration	5-percent Salt Concentration	6-percent Salt Concentration
20 (68)	1.025758	1.032360	1.038867
21 (69.8)	1.025480	1.032067	1.038560
22 (71.6)	1.025193	1.031766	1.038245
23 (73.4)	1.024899	1.031458	1.037924
24 (75.2)	1.024596	1.031142	1.037596
25 (77)	1.024286	1.030819	1.037261
26 (78.8)	1.023969	1.030489	1.036919
27 (80.6)	1.023643	1.030152	1.036570
28 (82.4)	1.023311	1.029808	1.036215
29 (84.2)	1.022971	1.029457	1.035853
30 (86)	1.022624	1.029099	1.035485
31 (87.8)	1.022270	1.028735	1.035110
32 (89.6)	1.021910	1.028364	1.034729
33 (91.4)	1.021542	1.027986	1.034343
34 (93.2)	1.021168	1.027602	1.033950
35 (95)	1.020787	1.027212	1.033551
36 (96.8)	1.020399	1.026816	1.033146
37 (98.6)	1.020006	1.026413	1.032735
38 (100.4)	1.019605	1.026005	1.032319
39 (102.2)	1.019199	1.025590	1.031897
40 (104)	1.018786	1.025170	1.031469

4.5.1.2 Pretest Standard Ambient Checkout.

All items require a pretest checkout at room ambient conditions to provide baseline data. Conduct the checkout as follows:

- Step 1. Prepare the test item in its required configuration in accordance with Part One, paragraph 5.8.1.
- Step 2. Record the room ambient temperature and humidity to determine if within standard ambient.
- Step 3. Conduct a complete visual examination of the test item with attention to:
 - (1) High-stress areas.
 - (2) Areas where dissimilar metals are in contact.
 - (3) Electrical and electronic components - especially those having closely spaced, unpainted or exposed circuitry.
 - (4) Metallic surfaces.
 - (5) Enclosed volumes where condensation has occurred or may occur.
 - (6) Components or surfaces provided with coatings or surface treatments for corrosion protection.
 - (7) Cathodic protection systems; mechanical systems subject to malfunction if clogged or coated with salt deposits.
 - (8) Electrical and thermal insulators.

² Data derived from equation information found in paragraph 6.1, reference c.

MIL-STD-810H
METHOD 509.7

NOTE: Consider partial or complete disassembly of the test item if a complete visual examination is required. Be careful not to damage any protective coatings, etc. during disassembly or reassembly.

- Step 4. Document the results. (Use photographs, if necessary.)
- Step 5. Conduct an operational checkout in accordance with the test plan, and record the results for compliance with Part One, paragraph 5.9.
- Step 6. If the test item meets the requirements of the test plan or other applicable documents, proceed to Step 1 of the test procedure below. If not, resolve any problems and restart the pretest standard ambient checkout at the most reasonable step above.

4.5.2 Procedure.

- Step 1. With the test item in the chamber, adjust the test chamber temperature to 35 °C (95 °F), and condition the test item for at least two hours before introducing the salt fog.
- Step 2. Continuously atomize a salt solution of a composition as given in paragraph 4.5.1.1b into the test chamber for a period of 24 hours or as specified in the test plan (see paragraph 2.2.3). During the entire exposure period, measure the salt fog fallout rate and pH of the fallout solution at least at 24-hour intervals^{3/}. Ensure the fallout is between 1 and 3 ml/80 cm²/hr with a pH between 6.5 and 7.2.
- Step 3. Dry the test item at standard ambient temperatures and a relative humidity of less than 50 percent for 24 hours, or as otherwise specified (see paragraph 2.2.3). Minimize handling the test item or adjusting any mechanical features during the drying period.
- Step 4. If the 48/48-hrs option has been chosen, proceed to Step 5. Otherwise, at the end of the drying period, repeat steps 1 to 3 at least once.
- Step 5. After completing the physical and any electrical checkouts, document the results with photographs. See paragraph 5 for analysis of results. If necessary to aid in the follow-on corrosion examination, use a gentle wash in running water that is at standard ambient conditions, conduct the corrosion examination, and document the results with photographs.
- Step 6. Visually inspect the test item in accordance with the guidelines given in paragraph 4.5.1.2.

5. ANALYSIS OF RESULTS.

In addition to the guidance provided in Part One, paragraphs 5.14 and 5.17, the following information is provided to assist in the evaluation of the test results.

- a. Physical. Salt deposits can cause clogging or binding of mechanical components and assemblies. The extent of any deposits resulting from this test may be representative of those induced by anticipated environments.
- b. Electrical. Salt deposits could cause electrical malfunctions.
- c. Corrosion. Analyze any corrosion for its immediate and potential long-term effects on the proper functioning and structural integrity of the test item.

NOTE: Moisture remaining after the 24-hour drying period could cause electrical malfunctions. If so, attempt to relate any malfunctions to that possible in service.

6. REFERENCE/RELATED DOCUMENTS.

6.1 Referenced Documents.

- a. ASTM B117, Standard Practice for Operating Salt Spray (Fog) Apparatus.
- b. Final Letter Report of Methodology Investigation on Evaluation of Test Procedures Used for Salt Fog Tests, TECOM Project 7-CO-PB7-AP1-018, Aberdeen Proving Ground, MD 21005; July 1979.

^{3/} Recommend more frequent intervals. Repeat the interval if fallout quantity requirements are not met.

MIL-STD-810H
METHOD 509.7

- c. Thermodynamic Properties of the NaCl + H₂O System II. Thermodynamic Properties of NaCl(aq), NaCl.2H₂O(cr), and Phase Equilibria; Published in: Journal of Physics and Chemistry Reference Data, Volume 21, No 4, 1992.

6.2 Related Documents.

- a. Synopsis of Background Material for MIL-STD-210B, Climatic Extremes for Military Equipment. Bedford, MA: Air Force Cambridge Research Laboratories, 24 January 1974. DTIC number AD-780-508.
- b. NATO STANAG 4370, Environmental Testing.
- c. NATO STANAG 4370, Allied Environmental Conditions and Test Publication (AECTP) 300, Climatic Environmental Tests, Method 309.
- d. Army Materiel Command Pamphlet AMCP-706-116, Engineering Design Handbook, Environmental Factors.
- e. MIL-HDBK-310, Global Climatic Data for Developing Military Products.
- f. NATO STANAG 4370, Allied Environmental Conditions and Test Publication (AECTP) 230, Climatic Conditions.
- g. AR 70-38, Research, Development, Test and Evaluation of Materiel for Extreme Climatic Conditions; Department of the Army Publications Website.
- h. Egbert, Herbert W. "The History and Rationale of MIL-STD-810 (Edition 2)," January 2010; Institute of Environmental Sciences and Technology, Arlington Place One, 2340 S. Arlington Heights Road, Suite 100, Arlington Heights, IL 60005-4516.

(Copies of Department of Defense Specifications, Standards, and Handbooks, and International Standardization Agreements are available online at <https://assist.dla.mil>.)

ASTM documents are available from the ASTM International Website.

Requests for other defense-related technical publications may be directed to the Defense Technical Information Center (DTIC), ATTN: DTIC-BR, Suite 0944, 8725 John J. Kingman Road, Fort Belvoir VA 22060-6218, 1-800-225-3842 (Assistance--selection 3, option 2), <http://www.dtic.mil/dtic/>; and the National Technical Information Service (NTIS), Springfield VA 22161, 1-800-553-NTIS (6847), <http://www.ntis.gov/>.

MIL-STD-810H
METHOD 510.7**METHOD 510.7**
SAND AND DUST**CONTENTS**

<u>Paragraph</u>	<u>Page</u>
1. SCOPE	1
1.1 PURPOSE	1
1.2 APPLICATION.....	1
1.3 LIMITATIONS	1
2. TAILORING GUIDANCE	1
2.1 SELECTING THE SAND AND DUST METHOD	1
2.1.1 EFFECTS OF SAND AND DUST ENVIRONMENTS	2
2.1.2 SEQUENCE AMONG OTHER METHODS.....	2
2.2 SELECTING PROCEDURES	2
2.2.1 PROCEDURE SELECTION CONSIDERATIONS	2
2.2.2 DIFFERENCE AMONG PROCEDURES.....	3
2.3 DETERMINE TEST LEVELS AND CONDITIONS	3
2.3.1 IDENTIFY CLIMATIC CONDITIONS	3
2.3.2 DETERMINE EXPOSURE CONDITIONS.....	3
2.3.3 TEST ITEM CONFIGURATION.....	3
3. INFORMATION REQUIRED.....	3
3.1 PRETEST.....	3
3.2 DURING TEST	4
3.3 POST-TEST	5
4. TEST PROCESS	5
4.1 PROCEDURE I - BLOWING DUST	5
4.1.1 TEST LEVELS AND CONDITIONS.....	5
4.1.1.1 TEMPERATURE	5
4.1.1.2 RELATIVE HUMIDITY	5
4.1.1.3 AIR VELOCITY.....	5
4.1.1.4 DUST COMPOSITION	6
4.1.1.5 DUST CONCENTRATIONS	7
4.1.1.6 ORIENTATION	7
4.1.1.7 DURATION.....	7
4.1.1.8 OPERATION DURING TEST.....	7
4.1.2 INFORMATION REQUIRED - REFER TO PARAGRAPHS 3.1 TO 3.3	8
4.1.3 TEST DETAILS	8
4.1.3.1 TEST FACILITY	8
4.1.3.2 CONTROLS.....	8
4.1.3.3 TEST INTERRUPTION.....	9
4.1.4 TEST EXECUTION	9
4.1.4.1 PREPARATION FOR TEST.....	9
4.1.4.2 TEST PROCEDURE I. BLOWING DUST.....	10
4.2 PROCEDURE II - BLOWING SAND.....	11
4.2.1 TEST LEVELS AND CONDITIONS.....	11

MIL-STD-810H
METHOD 510.7

CONTENTS - Continued

<u>Paragraph</u>	<u>Page</u>
4.2.1.1 TEMPERATURE	11
4.2.1.2 AIR VELOCITY.....	11
4.2.1.3 SAND COMPOSITION	12
4.2.1.4 SAND CONCENTRATIONS	12
4.2.1.5 ORIENTATION	12
4.2.1.6 DURATION.....	12
4.2.1.7 OPERATION DURING TEST.....	12
4.2.2 INFORMATION REQUIRED - REFER TO PARAGRAPHS 3.1 TO 3.3	13
4.2.3 TEST DETAILS	13
4.2.3.1 TEST FACILITY	13
4.2.3.2 CONTROLS.....	13
4.2.3.3 TEST INTERRUPTION.....	13
4.2.4 TEST EXECUTION	14
4.2.4.1 PREPARATION FOR TEST.....	14
4.2.4.2 TEST PROCEDURE II. BLOWING SAND	15
5. ANALYSIS OF RESULTS	16
5.1 BLOWING DUST TESTS	16
5.2 BLOWING SAND TESTS	16
6. REFERENCE/RELATED DOCUMENTS	16
6.1 REFERENCED DOCUMENTS.....	16
6.2 RELATED DOCUMENTS.....	17

MIL-STD-810H
METHOD 510.7**METHOD 510.7**
SAND AND DUST

NOTE: Tailoring is essential. Select methods, procedures, and parameter levels based on the tailoring process described in Part One, paragraph 4.2.2, and Annex C. Apply the general guidelines for laboratory test methods described in Part One, paragraph 5 of this Standard.

1. SCOPE.**1.1 Purpose.**

Sand and dust environments include a wide range of materials and particulate size distributions. Method 510 defines dust as particulates less than 150 μm in diameter. Sand is defined as particulates in the range from 150 to 850 μm in diameter. The test method includes two procedures:

- a. Dust (< 150 μm) procedure. This test is performed to evaluate the ability of materiel to resist the effects of dust that may obstruct openings, penetrate into cracks, crevices, bearings, and joints, and to evaluate the effectiveness of filters.
- b. Sand (150 to 850 μm particle size) procedure. This test is performed to evaluate the ability of materiel to be stored and operated in blowing sand conditions without degrading performance, effectiveness, reliability, and maintainability due to abrasion (erosion) or clogging effects of sharp-edged particles.

1.2 Application.

Use this Method to evaluate all mechanical, optical, electrical, electronic, electrochemical, and electromechanical devices (to include, but not limited to, platform mounted and man-portable) likely to be exposed to dry blowing sand or blowing dust-laden atmospheres.

1.3 Limitations.

This Method is not suitable for determining the effects of a buildup of electrostatic charge. Additionally, because of control problems, this Method does not address sand or dust testing outdoors. This Method doesn't address settling dust.

When a requirement exists for weapon system components such as windows/radomes, nose cones, airframes, leading edges, control surfaces, thermal protection systems, and fuzes to operate during weather encounter to include flight through abrasive particles, such as sand, dust and volcanic ash, a tailored test approach must be utilized based on the system configuration, trajectories, and system specific statistically based weather occurrence. Abrasive particles (sand, dust, ash) may vary depending on the global region and must be defined prior to ground test and evaluation. Traceability must be addressed between realistic flight through weather and ground test methods to ensure adequate performance characterization is achieved. Ground test methods include the use of sand/dust erosion facilities, multiple particle impact facilities, whirling-arm impact, ballistic gun ranges to induce high speed/hypersonic integrated sand, dust, and ash erosion effects on flight components. For hypersonic item testing consider utilizing the methods described in Technical Report AMR-PS-08-01. For Rotor Blade Material testing consider utilizing the method described in MIL-STD-3033.

2. TAILORING GUIDANCE.**2.1 Selecting the Sand and Dust Method.**

After examining requirements documents and applying the tailoring process in Part One of this Standard to determine where sand and dust environments are foreseen in the life cycle of the materiel, use the following to confirm the need for this Method and to place it in sequence with other methods.

MIL-STD-810H
METHOD 510.7

2.1.1 Effects of Sand and Dust Environments.

The blowing sand and dust environment is usually associated with hot-dry regions. It exists seasonally in most other regions. Naturally-occurring sand and dust storms are an important factor in the deployment of materiel, but the induced environment created by the operational (battlefield, training, etc.) environment can be more severe. Consider the following typical problems to help determine if this Method is appropriate for the materiel being tested. This list is not intended to be all-inclusive.

- a. Abrasion and erosion of surfaces.
- b. Penetration of seals.
- c. Degraded performance of electrical circuits.
- d. Obstruction/clogging of openings and filters.
- e. Physical interference with mating parts.
- f. Fouling/interference of moving parts.
- g. Reduction of heat transfer.
- h. Interference with optical characteristics.
- i. Overheating and fire hazard due to restricted ventilation or cooling.
- j. Wear (increased fretting due to imbedding between mating surfaces).
- k. Increased chaffing between non-mating contacting surfaces.
- l. Weight gain, static/dynamic balance.
- m. Attenuation of signal transmission.

2.1.2 Sequence Among Other Methods.

- a. General. Use the anticipated life cycle sequence of events as a general sequence guide (see Part One, paragraph 5.5).
- b. Unique to this Method. This Method will produce a dust coating on, or severe abrasion of, a test item that could influence the results of other MIL-STD-810 methods such as Solar Radiation (Method 505.7), Humidity (Method 507.6), Fungus (Method 508.8), and Salt Fog (Method 509.6). Therefore, use judgment in determining where in the sequence of tests to apply this Method. Additionally, results obtained from the Solar Radiation Test (Method 505.7) may be required to define temperature parameters used both in this Method and in High Temperature (Method 501.7). On the other hand, the presence of dust in combination with other environmental parameters can induce corrosion or mold growth. A warm humid environment can cause corrosion in the presence of chemically aggressive dust.

2.2 Selecting Procedures.

This Method includes two test procedures, Procedure I - Blowing Dust, and Procedure II - Blowing Sand.

Determine the procedure(s) to be used. If settling dust is of concern, concentration levels can be obtained from International Electrotechnical Commission (IEC) 60721-2-5, and test procedures for settling dust can be obtained from IEC 60068-2-68 Test Lb. For outdoor testing, guidance is provided in Test Operations Procedure (TOP) 01-2-621 Outdoor Sand and Dust Testing.

2.2.1 Procedure Selection Considerations.

When selecting procedures, consider:

- a. The operational purpose of the materiel. From the requirements documents, determine the functions to be performed by the materiel in a sand or dust environment and any limiting conditions such as storage.
- b. The natural exposure circumstances.
- c. The test data required to determine if the operational purpose of the materiel has been met.

MIL-STD-810H
METHOD 510.7

- d. Procedure sequence. If both sand and dust procedures are to be applied to the same test item, it is generally more appropriate to conduct the less damaging first, i.e., blowing dust and then blowing sand.

2.2.2 Difference Among Procedures.

While both procedures involve sand and/or dust, they differ on the basis of particle size and type of movement. These test procedures are tailorable to the extent that the user must specify the test temperature, sand and/or dust composition, test duration, and air velocity.

- a. Procedure I - Blowing Dust. Use Procedure I to investigate the susceptibility of materiel to concentrations of blowing dust (< 150 μm).
- b. Procedure II - Blowing Sand. Use Procedure II to investigate the susceptibility of materiel to the effects of blowing sand (150 μm to 850 μm).

2.3 Determine Test Levels and Conditions.

Having selected this Method and relevant procedures (based on the materiel's requirements documents and the tailoring process), it is necessary to complete the tailoring process by selecting specific parameter levels and special test conditions/techniques for these procedures based on requirements documents, Life Cycle Environmental Profile (LCEP), and information provided with this Method. From these sources of information, determine the functions to be performed by the materiel in sand and dust environments, or following storage in such environments. Then determine the sand and dust levels of the geographical areas and micro-environments in which the materiel is designed to be employed. To do this, consider the following in light of the operational purpose and life cycle of the materiel.

2.3.1 Identify Climatic Conditions.

Identify the appropriate climatic conditions for the geographic areas in which the materiel will be operated and stored, and whether or not test item needs to be operated during the test.

2.3.2 Determine Exposure Conditions.

Base the specific test conditions on field data if available. In the absence of field data, determine the test conditions from the applicable requirements documents. If this information is not available, use the configuration guidance in paragraph 2.3.3, as well as guidance provided in paragraphs 4.1.1 and 4.2.1 for procedures I and II, respectively.

2.3.3 Test Item Configuration.

Use a test item configuration that reproduces, as close as possible, the anticipated materiel configuration during storage or use, such as:

- a. Enclosed in a shipping/storage container or transit case.
- b. Protected or unprotected.
- c. Deployed realistically or with restraints, such as with openings that are normally covered.

3. INFORMATION REQUIRED.

3.1 Pretest.

The following information is required to conduct sand and dust tests adequately.

- a. General. Information listed in Part One, paragraphs 5.7 and 5.9; and Annex A, Task 405 of this Standard.
- b. Specific to this Method.
 - (1) Applicable for both procedures in this Method:
 - (a) Test temperature(s).
 - (b) Composition of the dust or sand.
 - (c) Concentration of the dust or sand.
 - (d) Operating requirements.

MIL-STD-810H
METHOD 510.7

- (e) Test item orientation (incident angle).
 - (f) Exposure time per orientation.
 - (g) Methods of sand or dust removal used in service.
 - (h) Air velocity.
 - (i) Procedures for determining the test item's degradation due to abrasion (if required).
 - (j.) Operational Test Instructions including time period of operation and test item performance (if required).
 - (k.) Any additional parameters to be measured and recorded, if required. (i.e., Weight, balance, fluid contamination)
- (2) Specific to Procedure I (Dust): Relative humidity.
- c. Tailoring. Necessary variations in the basic test procedures to accommodate environments identified in the LCEP.

3.2 During Test.

Collect the following information during conduct of the test:

- a. General. Information listed in Part One, paragraph 5.10; and in Annex A, Tasks 405 and 406 of this Standard.
- b. Specific to this Method.
 - (1) Applicable for both procedures in this Method.
 - a. Air velocity calibration of fan settings (if the velocity is not continuously measured and recorded). Any calibrations of feed rates or chamber checkouts required to prove proper application of the applied environment.
 - b. Pretest photographs of the item and test setup.
 - c. Photographic documentation prior to and following each change in test item orientation or cleaning.
 - d. Any deviations from the test plan.
 - e. Photographic documentation showing the orientation of the test item with respect to the air flow.
 - f. Documentation of operating and non-operating periods as well as any functional tests conducted.
 - g. Document when thermal stabilization of the test item was achieved for the purpose of evaluating the duration of high temperature exposure.
 - (2) Specific to Procedure I (Dust).
 - a. Relative humidity vs. Time.
 - b. Dust Concentration vs. Time
 - c. Wind Speed vs. Time or record of measurements performed to calibrate wind speed just prior to the testing.
 - (3) Specific to Procedure II (Sand).
 - a. Sand Concentration vs. Time or record of measurements performed to calibrate sand concentration just prior to the testing.
 - b. Wind Speed vs. Time or record of measurements performed to calibrate wind speed just prior to the testing.

MIL-STD-810H
METHOD 510.7

3.3 Post-Test.

The following post data shall be included in the test report.

- a. General. Information listed in Part One, paragraph 5.13; and in Annex A, Task 406 of this Standard.
- b. Specific to this Method.
 - (1) Applicable for both procedures in this Method.
 - (a) Initial test item orientation and any orientation change during test.
 - (b) Values of the test variables for each section of the test (temperature, air velocity, sand or dust concentrations, humidity and duration).
 - (c) Results of each visual inspection.
 - (d) Any deviations from the test plan.
 - (e) Composition of the dust or sand.
 - (f) Detailed post test photographs.
 - (g) Documentation of abrasion areas.
 - (h) Documentation of any sand or dust intrusions.
 - (i) Documentation of the cleaning methods performed. Detailed photographs before and after cleaning methods are applied.

4. TEST PROCESS.

4.1 Procedure I – Blowing Dust.

4.1.1 Test Levels and Conditions.

4.1.1.1 Temperature.

Unless otherwise specified, conduct the blowing dust tests with the test item at standard ambient and the high operating or storage temperature. In the absence of this information, perform the tests at the maximum ambient air temperature for the A1 climatic category induced or ambient, as required.

4.1.1.2 Relative Humidity.

High levels of relative humidity (RH) may cause caking of dust particles. Consequently, control the test chamber RH to not exceed 30 percent.

4.1.1.3 Air Velocity.

Use a reduced air velocity of 1.5 ± 1 m/s (300 ± 200 ft/min) to maintain test temperature conditions, and a higher air velocity of 8.9 ± 1.3 m/s (1750 ± 250 ft/min) typical of desert winds, to be used in the absence of specified values. Use other air velocities if representative of natural conditions. The lower air speed during temperature conditioning is to ensure that airborne dust within the chamber is minimized and the pressure applied to the dust laden test item due to wind speed is minimized during this period.

For typical testing, uniform wind speeds are provided across the test area. If the test item is large and at ground level some consideration should be given to account for the wind profile from the ground to the test item height.

Wind speed verification typically takes place prior to the testing. For this verification, the sampling rate for wind speed measurements will be a minimum of 4 samples per second. The steady state (sustained) wind speeds will be verified by averaging the wind speeds over 10 seconds with the wind generation equipment controls held constant.

MIL-STD-810H
METHOD 510.7

4.1.1.4 Dust Composition.

WARNING

Refer to the supplier's Safety Data Sheet (SDS) or equivalent for health hazard data. Exposure to silica flour (ground quartz) can cause silicosis; other material may cause adverse health effects.

- a. The main mineral constituents of dust derived from soils and sediments are quartz, feldspars, calcite (carbonate), dolomite, micas, chlorite, and a variety of heavy oxides and amorphous inorganic material and organic matter. Dust can also include mixed layer clays consisting of kaolinite, illite, and smectite. In arid regions, soluble salts are common components of dust and include calcite, gypsum, and halite, as well as the mineral opal and the clay palygorskite. In some regions, the dust-related problems with materiel such as fouling, interference of moving parts, increased electrical conductivity, and corrosion can be more pronounced if there are more reactive constituents in the natural dust. Using a dust material with a chemical composition close to that of the dust in the region being considered may give a realistic simulation of some of these effects on materiel in the blowing dust test. For example, mixed layer clays swell upon contact with fluids such as lubricants, and can cause parts to stick or seize. Carbonates can enhance the formation of scale on metal alloys and can cause shorting in electrical assemblies. These compounds can also cause corrosion in humid conditions. Other components such as soluble salts will result in both corrosion and abrasion resulting in electrical and physical malfunctions.
- b. For tests to realistically represent these potential failure modes, natural dust from the region should be used, or a test dust that contains a close approximation of the components in the natural dust. When it may not be practical to obtain the natural material from the region of interest, the material closest in composition should be used for the test. These test dust materials should be chosen with deliberate consideration of these reactive properties as much as possible. If necessary, compounds can be mixed in with the more inert dust materials to achieve the necessary dust composition and a more realistic test outcome. Although the silica (quartz) content is generally the primary component of natural dust, it is usually less than 80 % of the sample mass. Silica is chemically non-reactive, but it can be abrasive and will cause wear and erosion of surfaces. Some regional dust may also contain a greater amount of clay-sized particles.
- c. Particle size distribution must also be considered. A particle size distribution of 100 percent by weight less than 150 μm , with a median diameter (50 percent by weight) of $20 \pm 5 \mu\text{m}$ has been used in prior testing and is recommended.
- d. If dust from a region of interest or its analog is not available, a blowing dust test procedure may be conducted using the following dust compositions, by weight. The dust compositions are given in decreasing order of similarity to real world conditions.

(1) Red china clay has been used as a surrogate for dust commonly found worldwide and contains:

CaCO ₃ , MgCO ₃ , MgO, TiO ₂ , etc.	5 percent
Ferric oxide (Fe ₂ O ₃)	10 \pm 5 percent
Aluminum oxide (Al ₂ O ₃)	20 \pm 10 percent
Silicon dioxide (SiO ₂)	remaining percentage (50 to 80 %)

(2) Silica flour, although not truly representative of dust found in the natural environment (except for particle size), has been widely used in dust testing and contains 97 to 99 percent (by weight) silicon dioxide. A 140 mesh Silica Flour (about 2 percent retained on a 140 mesh (106 microns) sieve) has a particle size distribution of 100 percent by weight less than 150 μm , with a median diameter (50 percent by weight) of $20 \pm 5 \mu\text{m}$. ASTM D185-07, Standard Test Methods for Coarse Particles in Pigments, provides a method for particle size measurements by sieve analysis. If particle size measurements are carried out using techniques other than sieve analysis, it must be demonstrated that the same results are produced. This type of dust is readily available and should produce comparable

MIL-STD-810H
METHOD 510.7

results to prior tests. Silica dust (ground quartz) has been found to provide adequate effects with regard to penetration or binding and abrasion. This is an inert compound that does not produce the effects that result from exposure to natural dust containing reactive components.

- (3) Other materials used for dust testing are less desirable and may have a particle size distribution that falls below that in paragraph 4.1.1.4c above. However, use unique dust compositions if the compositions are known. Ensure material to be used is appropriate for the intended purpose and regions of the world being simulated; e.g., for dust penetration, ensure the particle sizes are no larger than those identified for the region. These materials for dust testing include talcum powder (talc) (hydrated magnesium silicate), fire extinguisher powder (F.E.) (composed mainly of sodium or potassium hydrogen carbonate with a small amount of magnesium stearate bonded to the surface of the particles in order to assist free-running and prevent clogging. F.E. must be used in dry conditions to prevent corrosive reaction and formation of new chemicals (paragraph 6.1, reference c)), quartz (a constituent of many dusts occurring in nature), and undecomposed feldspar and olivine (that have similar properties to quartz).

4.1.1.5 Dust Concentrations.

Unless otherwise specified, maintain the dust concentration for the blowing dust test at $10.6 \pm 7 \text{ g/m}^3$ ($0.3 \pm 0.2 \text{ g/ft}^3$). This concentration exceeds that normally associated with moving vehicles, aircraft, and troop movement, but has historically proven to be a reliable concentration for blowing dust tests using silica flour (ground quartz) material. If available, use a dust concentration based on natural environment data or other historical information to accurately represent the specific service condition.

4.1.1.6 Orientation.

Unless otherwise specified, orient the test item such that the most vulnerable surfaces face the blowing dust. Using the specified test duration, rotate the test item, if required, at equal intervals to expose all vulnerable surfaces. When possible, evaluate of the airflow around the test item in-service to determine required chamber boundary conditions to create similar airflow and cooling conditions.

Consider removal of the dust accumulation during the reorientation of the test item. See section 4.1.1.9.

4.1.1.7 Duration.

Unless otherwise specified, conduct blowing dust tests for at least 6 hours at standard ambient temperature, and an additional 6 hours at the high storage or operating temperature. If necessary, stop the test after the first 6-hour period, provided that prior to starting the second 6-hour period, the test item and chamber conditions are re-stabilized. If necessary, rotate the item to expose each vulnerable side during each of the 6-hours of exposure.

If facility limitations do not allow for the coverage of an entire face of the test item, the length of overall exposure should be extended to allow for the equivalent amount of exposure that would be performed if the facility limitation did not exist. For example, if an item with four vulnerable sides is being testing, but the facility can only cover half of each face, two exposures would be needed for each face. In this case the total time of testing would be doubled.

4.1.1.8 Operation During Test.

Determine the need to operate the test item during exposure to dust from the anticipated in-service operational requirements. If the test item must be operated, specify the time and periods of operation in the test plan. Include at least one 10-minute period of operation of the test item during the last hour of the test, with the test item's most vulnerable surface(s) facing the blowing dust. If the item is to be operated throughout a dust event in the field it is recommended that the item be operated throughout the dust exposures. Ensure the period of operation includes the essential operational requirements to include proper operation of environmental conditioning units (ECUs) for enclosures.

A build-up of dust will reduce the ability of the test item to shed the thermal load generated by electronics. If dust accumulations are expected in the field, perform the operational test without removing the dust. To fully evaluate the performance of the dust laden materiel in low wind speed and high temperature conditions, consider performing a high temperature operational test on the dust laden materiel using the procedures provided in Methods 501 or 505.

MIL-STD-810H
METHOD 510.7

Consider removal of the dust accumulation prior to operation of the test item. See section 4.1.1.9.

Consider manipulation of the test item as part of the operational test. This may uncover issues with binding or wear of moving parts. The test item should be manipulated in the same manner it would be utilized in the field in a dust laden environment. For example, the wear of hydraulic, pneumatic seals, or operator controls may not occur without repetitive use/manipulation of the equipment during testing.

4.1.1.9 Removal of Dust Accumulations.

Experience has shown that dust accumulations of 13 mm (0.5 inch) on the test item are not uncommon during the chamber dust exposure. This can create a condition that may not be experienced in the life cycle of the test item. This layer of dust may form a protective layer over the seals. Removing the dust during the reorientation of the test item may provide a more realistic application of the fielded environment. If dust removal is to be performed, the item specific dust removal procedures shall be documented prior to test in the approved test plan.

In the event of an operational test this build-up of dust will reduce the ability of the test item to shed the thermal load generated by electronics. If dust accumulations are expected in the field perform the operational test without removing the dust. If the item will be routinely maintained or exposed to other environments (high winds, rain, etc.) that will mitigate dust buildup consider removing the dust prior to operation.

Procedures for dust removal must reflect the in service use in accordance with the field manual with the tools available in the field. Remove accumulated dust from the test item by brushing or wiping taking care to avoid introduction of additional dust or disturbing any that may have already entered the test item. Do not remove dust by either air blast or vacuum cleaning unless these methods are likely to be used in service.

Photographs prior to and following the dust removal must be performed.

4.1.2 Information Required – Refer to Paragraphs 3.1 to 3.3.**4.1.3 Test Details.****4.1.3.1 Test Facility.**

- a. Ground the test item and facility to avoid buildup of an electrostatic charge. Verify resistance/continuity in accordance with applicable safety requirements for the materiel. Employ a data collection system to measure the test volume conditions (see Part One, paragraph 5.18). Except for gaseous nitrogen (GN₂), achieve dehumidification, heating and cooling of the air envelope surrounding the test item by methods that do not change the chemical composition of the air, dust, and water vapor within the chamber test volume air.
- b. Use a test facility that consists of a chamber and accessories to control dust concentration, velocity, temperature, and humidity of dust-laden air. Ensure that the dust is uniformly distributed in the air stream. In order to provide adequate circulation of the dust-laden air, use a test chamber of sufficient size that no more than 50 percent of the test chamber's cross-sectional area (normal to airflow) and 30 percent of the volume of the test chamber is occupied by the test item(s). Maintain and verify the concentration of dust in circulation within the chamber with suitable instrumentation such as a calibrated smoke meter and standard light source. When using this method ensure that the light source and smoke meter are kept free of dust accumulations and lens abrasion, use of a dry air purge system is a common methodology. Introduce the dust-laden air into the test space in such a manner as to allow the air to become as close to laminar as possible, but at least in a manner that prevents excessive turbulence as the flow of dust-laden air strikes the test item.
- c. Use dust in this test as outlined in paragraph 4.1.1.4 above.

4.1.3.2 Controls.

- a. Maintain the test chamber relative humidity (RH) at 30 percent or less to prevent caking of dust particles.

MIL-STD-810H
METHOD 510.7

- b. Record chamber temperature and humidity in accordance with Part One, paragraphs 5.2 and 5.18, and dust concentration at a sufficient rate (at least once every 5 minutes) to satisfy the post-test analysis (see Part One, paragraph 5.18).

4.1.3.3 Test Interruption.

Test interruptions can result from two or more situations, one being from failure or malfunction of test chambers or associated test laboratory equipment. The second type of test interruption results from failure or malfunction of the test item itself during operational checks.

4.1.3.3.1 Interruption Due To Chamber Malfunction.

- a. General. See Part One, paragraph 5.11 of this Standard.
- b. Specific to this Method.
- (1) Undertest interruption. Follow any undertest interruption by reestablishing the prescribed test conditions and continue from the point of interruption.
 - (2) Overtest interruption. Following exposure to excessive dust concentrations, remove as much of the accumulation as possible (as would be done in service) and continue from the point of interruption. If abrasion is of concern, either restart the test with a new test item or reduce the exposure period by using the concentration-time equivalency (assuming the overtest concentration rate is known).

4.1.3.3.2 Interruption Due To Test Item Operation Failure.

Failure of the test item(s) to function as required during operational checks presents a situation with several possible options.

- a. The preferable option is to replace the test item with a “new” one and restart from Step 1.
- b. A second option is to replace / repair the failed or non-functioning component or assembly with one that functions as intended, and restart the entire test from Step 1.

NOTE: When evaluating failure interruptions, consider prior testing on the same test item and consequences of such.

4.1.4 Test Execution.

The following steps, alone or in combination, provide the basis for collecting necessary information concerning the test item in dust environments.

4.1.4.1 Preparation for Test.

WARNING: The relatively dry test environment combined with the moving air and organic dust particles may cause a buildup of electrostatic energy that could affect operation of the test item. Use caution when making contact with the test item during or following testing if organic dust is used, and be aware of potential anomalies caused by electrostatic discharge during test item checkout.

4.1.4.1.1 Preliminary Steps.

Before starting the test, review pretest information in the currently approved test plan to determine test details (e.g., procedures, item configuration, cycles, durations, parameter levels for storage/operation, etc.). (See paragraph 3.1, above.)

- a. Determine from the test plan specific test variables to be used.
- b. Operate the test chamber without the test item to confirm proper operation. Adjust the air system or test item position to obtain the specified air velocity for the test item.

MIL-STD-810H
METHOD 510.7

4.1.4.1.2 Pretest Standard Ambient Checkout.

All items require a pretest standard ambient checkout to provide baseline data. Conduct the pretest checkout as follows:

- Step 1. Conduct a complete visual examination of the test item with special attention to sealed areas and small/minute openings, and document the results.
- Step 2. Prepare the test item in its operating configuration or as otherwise specified in the test plan. Install test item instrumentation as required by the test plan. When applying surface mount thermocouples, minimize the coverage of the test item surface to the greatest extent possible.
- Step 3. Position the test item as near the center of the test chamber as possible and from any other test item (if more than one item is being tested). Orient the test item to expose the most critical or vulnerable parts to the dust stream. Ensure the test item is grounded (either through direct contact with the test chamber or with a grounding strap).

NOTE: If required by the test plan, change the orientation of the test item during the test as specified.

- Step 4. Stabilize the test item temperature at standard ambient conditions.
- Step 5. Conduct an operational checkout in accordance with the test plan and record results.
- Step 6. If the test item operates satisfactorily, proceed to Step 1 of the test procedure. If not, resolve the problem and restart at Step 1 of pretest checkout.

4.1.4.2 Test Procedure I. Blowing Dust.

WARNING: Refer to the supplier's Safety Data Sheet (SDS) or equivalent for health hazard data. Exposure to silica flour (ground quartz) can cause silicosis; other material may cause adverse health effects.

NOTE: Unless the requirements documents indicate otherwise, if the following test procedure is interrupted because of work schedules, etc., maintaining the test item at the test temperature for the time required will facilitate completion of the test when resumed. If the temperature is changed, before continuing the test, re-stabilize the test item at the temperature of the last successfully completed period before the interruption.

CAUTION: When temperature conditioning, ensure the total test time at elevated temperatures does not exceed the life expectancy of any safety critical materials. This is particularly applicable to energetic materials (see Part One, paragraph 5.19).

- Step 1. With the test item in the chamber and stabilized at standard ambient temperature, adjust the air velocity to 8.9 ± 1.3 m/s (1750 ± 250 ft/min), or as otherwise determined from the test plan. Adjust the relative humidity to less than 30% and maintain it throughout the test.
- Step 2. Adjust the dust feed control for a dust concentration of 10.6 ± 7 g/m³ (0.3 ± 0.2 g/ft³)
- Step 3. Unless otherwise specified, maintain the conditions of Steps 1 and 2 for at least 6 hours. If required, periodically reorient the test item to expose other vulnerable faces to the dust stream. If required, perform dust removal when the test item is reoriented (See paragraph 4.1.1.9). **SEE THE ABOVE WARNING REGARDING HEALTH HAZARDS.** If required, operate the test item in accordance with the test plan. If the test item fails to operate as intended, follow the guidance in paragraph 4.2.3.3.2. Otherwise proceed to Step 4.

MIL-STD-810H
METHOD 510.7

- Step 4. Stop the dust feed. (See paragraph 4.1.1.7.) If required, operate the test item in accordance with the test plan. Reduce the test section air velocity to 1.5 ± 1 m/s (300 ± 200 ft/min) and adjust the temperature to the required high operational temperature (see paragraph 4.1.1.1), or as otherwise determined from the test plan. The rate of temperature change shall be no greater than $3^{\circ}\text{C}/\text{min}$ ($5.4^{\circ}\text{F}/\text{min}$).
- Step 5. Maintain the Step 4 conditions for a minimum of 1 hour following test item temperature stabilization.
- Step 6. Adjust the air velocity to that used in Step 1, and restart the dust feed to maintain the dust concentration as in Step 2.
- Step 7. Continue the exposure for at least 6 hours or as otherwise specified. If required perform the following:
- Periodically reorient the test item to expose other vulnerable faces to the dust stream.
 - Perform dust removal when the test item is reoriented. See paragraph 4.1.1.9. Take photographs prior to and following dust removal.
 - Operate and/or manipulate the test item in accordance with the test plan. If the test item fails to operate as intended, follow the guidance in paragraph 4.2.3.3.2. Otherwise proceed to Step 8.
- SEE THE ABOVE WARNING REGARDING HEALTH HAZARDS.**
- Step 8. Stop the dust feed, stop or reduce the air speed to no greater than 2.5 m/s (500 ft/min), and allow the test item to return to standard ambient conditions at a rate not to exceed $3^{\circ}\text{C}/\text{min}$ ($5^{\circ}\text{F}/\text{min}$). Stop any air flow and allow the dust to settle (possibly up to 1 hour).
- Step 9. Photograph the test item to document dust accumulation.
- Step 10. Remove accumulated dust from the test item by brushing or wiping, taking care to avoid introduction of additional dust or disturbing any that may have already entered the test item. See paragraph 4.1.1.9. Do **NOT** remove dust by either air blast or vacuum cleaning unless these methods are likely to be used in service. **SEE THE ABOVE WARNING REGARDING HEALTH HAZARDS.**
- Step 11. Inspect the test item for dust penetration, giving special attention to bearings, seals, lubricants, filters, ventilation points, etc. Document the results.
- Step 12. Perform an operational check in accordance with the approved test plan, and document the results for comparison with pretest data. See paragraph 5.1 for analysis of results.
- Step 13. If required, clean the test item further to ensure that personnel that will be handling or occupying the test item are not exposed to unnecessary health hazards.

4.2 Procedure II – Blowing Sand.

4.2.1 Test Levels and Conditions.

4.2.1.1 Temperature.

Unless otherwise specified, conduct the blowing sand tests with the test item at the high operating or storage temperature. In the absence of this information, perform the tests at the maximum ambient air temperature for the A1 climatic category induced or ambient, as required.

4.2.1.2 Air Velocity.

Winds of 18 m/s (40 mph) capable of blowing the large particle sand are common, while gusts up to 29 m/s (65 mph) are not unusual. Recommend using an air velocity of 18 m/s (40 mph) or greater to ensure the blowing sand particles remain suspended in the air stream. If the induced flow velocity around the materiel in its field application is known to be outside of this range, use the known velocity.

NOTE: Ensure the sand particles impact the test item at velocities ranging from 18-29 m/s (40-65 mph). In order for the particles to attain these velocities, maintain an approximate distance of 3 m (10 ft) from the sand injection point to the test item. Use shorter distances if it can be proven the particles achieve the necessary velocity at impact.

MIL-STD-810H
METHOD 510.7

For typical testing, uniform wind speeds are provided across the test area. If the test item is large and at ground level some consideration should be given to account for the wind profile from the ground to the test item height.

The sampling rate for wind speed measurements will be a minimum of 4 samples per second. The steady state wind speeds will be verified by averaging the wind speeds over 10 seconds with the wind generation equipment controls held constant. A gust is defined as a 3 second period at the level of increased wind speed. When performing a test with gusts, a minimum of four gusts per hour is recommended. The accuracy of wind measurement devices, such as cup, propeller and hot wire anemometers, are negatively affected by the sand and dust environment, therefore wind speed measurements should be taken in clean air with these devices. Variation in wind direction, or high turbulence, can also influence cup and propeller measurement accuracy.

4.2.1.3 Sand Composition.

WARNING: Refer to the supplier's Safety Data Sheet (SDS) or equivalent for health hazard data. Exposure to crystalline silica can cause silicosis; other material may cause adverse health effects.

Unless otherwise specified, for the sand test, use quartz sand (at least 95 percent by weight SiO₂). Use sand of sub-angular structure, a mean Krumbein number range of 0.5 to 0.7 for both roundness and sphericity, and a hardness factor of 7 Mohs. Due to the loss of subangular structure and contamination, re-use of test sand is normally not possible. If possible, determine the particle size distribution from the geographical region in which the materiel will be deployed. There are 90 deserts in the world, each with different particle size distributions. Therefore, it is impossible to specify a particle size distribution that encompasses all areas. The recommended particle size distribution for the sand test is from 150 µm to 850 µm, with a mean of 90 ±5 percent by weight smaller than 600 µm and larger than or equal to 150 µm, and at least 5 percent by weight 600 µm and larger. When materiel is designed for use in a region that is known to have an unusual or special sand requirement, analyze a sample of such sand to determine the distribution of the material used in the test. Specify the details of its composition in the requirements documents.

4.2.1.4 Sand Concentrations.

Unless otherwise specified, maintain the sand concentrations as follows (references 6.1a & b):

- a. For materiel likely to be used close to helicopters and other aircraft operating over unpaved surfaces: 2.2 ±0.5 g/m³.
- b. For materiel never used or exposed in the vicinity of operating aircraft, but that may be used or stored unprotected near operating surface vehicles: 1.1 ±0.3 g/m³.
- c. For materiel that will be subjected only to natural conditions: 0.18 g/m³, -0.0/+0.2 g/m³. (This large tolerance is due to the difficulties of measuring concentrations at low levels.)

NOTE: If the wind velocity is increased intermittently to simulate a gust it is permissible to allow the sand concentration to be reduced for this period of time of intermittent increase in wind speed.

4.2.1.5 Orientation.

Orient the test item with respect to the direction of the blowing sand such that the test item will experience maximum erosion effects. The test item may be re-oriented at 90-minute intervals. Consider the incident angle of sand particle impact on the severity of erosion in selecting orientations. When possible, evaluate of the airflow around the test item in-service to determine required chamber boundary conditions to create similar airflow and cooling conditions.

4.2.1.6 Duration.

Perform blowing sand tests for a minimum of 90 minutes per each vulnerable face.

MIL-STD-810H
METHOD 510.7

4.2.1.7 Operation During Test.

Determine the need to operate the test item during exposure to sand from the anticipated in-service operational requirements. For example, in addition to items that are exposed directly to natural conditions, consider items inside environmentally controlled enclosures that should be operated while the enclosure is exposed to the blowing sand environment. This should include operation of ECUs to ensure the adverse environment does not result in a failure of the test item to meet performance requirements. If the test item must be operated during the test, specify the time and periods of operation in the test plan. Include at least one 10-minute period of operation of the test item during the last hour of the test, with the test item's most vulnerable surface facing the blowing sand. Ensure the period of operation includes the essential operational requirements.

A build-up of sand, especially in internal compartments, will reduce the ability of the test item to shed the thermal load generated by electronics. If sand accumulations are expected in the field, perform the operational test without removing the sand. To fully evaluate the performance of the sand laden materiel in low wind speed and high temperature conditions, consider performing a high temperature operational test on the sand laden materiel using the procedures provided in Methods 501 or 505.

Consider manipulation of the test item as part of the operational test. This may uncover issues with binding or wear of moving parts. The test item should be manipulated in the same manner it would be utilized in the field in a desert environment.

4.2.2 Information Required – Refer to Paragraphs 3.1 to 3.3.

4.2.3 Test Details.

4.2.3.1 Test Facility.

- a. Ground the test item and facility to avoid buildup of an electrostatic charge. Verify resistance/continuity in accordance with applicable safety requirements for the materiel. Employ a data collection system to measure the test volume conditions (see Part One, paragraph 5.18). Except for gaseous nitrogen (GN₂), achieve dehumidification, heating and cooling of the air envelope surrounding the test item by methods that do not change the chemical composition of the air, dust, sand, and water vapor within the chamber test volume air. The following information is also appropriate.
- b. Test facility design considerations.
 - (1) In order to provide adequate circulation of the sand-laden air, use a test chamber of sufficient size that no more than 50 percent of the test chamber's cross-sectional area (normal to airflow) and 30 percent of the volume of the test chamber is occupied by the test item(s).
 - (2) Control the sand feeder to emit the sand at the specified concentrations. To simulate the effects produced in the field, locate the feeder to ensure the sand is approximately uniformly suspended in the air stream when it strikes the test item.
 - (3) Because of the abrasive characteristics of blowing sand, do not re-circulate the sand through the fan or air conditioning equipment.

4.2.3.2 Controls.

Record chamber temperature and humidity in accordance with Part One, paragraphs 5.2 and 5.18 at a sufficient rate to satisfy the post-test analysis (see Part One, paragraph 5.18), and provide sand rate calculations for each test interval. Verify chamber air velocity and sand concentration prior to test. Calculate the sand feed rate and verify it by measuring the sand quantity delivered over unit time using the following formula:

$$\text{Feed Rate} = (\text{Concentration})(\text{Area})(\text{Velocity})$$

where:

Feed Rate = mass of sand introduced into the test chamber per set time interval

Concentration = sand concentration required by the test plan

Area = cross-sectional area of the sand laden wind stream at the test item location.

Velocity = average velocity of air across the cross-sectional area at the test item location

MIL-STD-810H
METHOD 510.7

4.2.3.3 Test Interruption.

Test interruptions can result from two or more situations, one being from failure or malfunction of test chambers or associated test laboratory equipment. The second type of test interruption results from failure or malfunction of the test item itself during operational checks.

4.2.3.3.1 Interruption Due To Chamber Malfunction.

- a. General. See Part One, paragraph 5.11 of this Standard.
- b. Specific to this Method.
 - (1) Undertest interruption. Follow any undertest interruption by reestablishing the prescribed test conditions and continue from the point of interruption.
 - (2) Overtest interruption. Following exposure to excessive sand concentrations, remove as much of the accumulation as possible (as would be done in service) and continue from the point of interruption. If abrasion is of concern, either restart the test with a new test item or reduce the exposure period by using the concentration-time equivalency (assuming the overtest concentration rate is known).

4.2.3.3.2 Interruption Due To Test Item Operation Failure.

Failure of the test item(s) to function as required during operational checks presents a situation with several possible options.

- a. The preferable option is to replace the test item with a “new” one and restart from Step 1.
- b. A second option is to replace / repair the failed or non-functioning component or assembly with one that functions as intended, and restart the entire test from Step 1.

NOTE: When evaluating failure interruptions, consider prior testing on the same test item and consequences of such.

4.2.4 Test Execution.

The following steps, alone or in combination, provide the basis for collecting necessary information concerning the test item in sand environments.

4.2.4.1 Preparation For Test.

WARNING: The relatively dry test environment combined with the moving air, sand particles may cause a buildup of electrostatic energy that could affect operation of the test item. Be aware of potential anomalies caused by electrostatic discharge during test item checkout.

4.2.4.1.1 Preliminary Steps.

Before starting the test, review pretest information in the currently approved test plan to determine test details (e.g., procedures, item configuration, cycles, durations, parameter levels for storage/operation, etc.). (See paragraph 4.2.1, above.)

- a. Determine from the test plan specific test variables to be used.
- b. Operate the test chamber without the test item to confirm proper operation.
 - (1) Calibrate the sand dispensing system for the sand concentration specified in the test plan.
 - (2) Operate the test chamber without the test item to confirm proper operation. Adjust the air system or test item position to obtain the specified air velocity for the test item.

MIL-STD-810H
METHOD 510.7

4.2.4.1.2 Pretest Standard Ambient Checkout.

All items require a pretest standard ambient checkout to provide baseline data. Conduct the pretest checkout as follows:

- Step 1. Conduct a complete visual examination of the test item with special attention to sealed areas and small/minute openings, and document the results.
- Step 2. Prepare the test item in its operating configuration or as specified in the test plan. Install test item instrumentation as required by the test plan. When applying surface mount thermocouples, minimize the coverage of the test item surface to the greatest extent possible.
- Step 3. Position the test item at the required distance from the sand injection point. Orient the test item to expose the first face to the sand stream.
- Step 4. Ensure the test item is grounded (either through direct contact with the test chamber or with a grounding strap).

NOTE: If required to change the orientation during the test, ensure that the instrumentation and fixtures will allow this to occur.

- Step 5. Stabilize the test item temperature at standard ambient conditions.
- Step 6. Conduct an operational checkout in accordance with the test plan and record the results.
- Step 7. If the test item operates satisfactorily, proceed to Step 1 of the test procedure. If not, resolve the problem and restart at Step 1 of pretest checkout.

4.2.4.2 Test Procedure II. Blowing Sand

WARNING:

1. Refer to the supplier's Safety Data Sheet (SDS) or equivalent for health hazard data.
2. The relatively dry test environment combined with the moving air and sand particles may cause a buildup of electrostatic energy that could affect operation of the test item.

NOTE: Unless the requirements documents indicate otherwise, if the following test procedure is interrupted because of work schedules, etc., maintaining the test item at the test temperature for the time required will facilitate completion of the test when resumed. If the temperature is changed, before continuing the test, re-stabilize the test item at the temperature of the last successfully completed period before the interruption.

CAUTION: When temperature conditioning, ensure the total test time at elevated temperatures do not exceed the life expectancy of any safety critical materials. This is particularly applicable to energetic materials (see Part One, paragraph 5.19).

- Step 1. Increase the chamber temperature (at a rate not to exceed 3 °C/min (5 °F/min)) and stabilize the test item at the required high temperature (see paragraph 4.2.1.1).
- Step 2. Adjust the air velocity according to test plan (see paragraph 4.2.1.2).
- Step 3. Adjust the sand feeder to obtain the sand mass flow rate determined from the pretest calibration.
- Step 4. Maintain the conditions of Steps 1 through 3 for the duration specified in the test plan. If required, interrupt the blowing sand and re-orient the test item at 90-minute intervals to expose all vulnerable faces to blowing sand, and repeat Steps 1-3.
- Step 5. If operation of the test item during the test is required, perform an operational test with the most vulnerable face exposed during the last hour of the test, and document the results. If the test item fails to operate as intended, follow the guidance in paragraph 4.2.3.3. Otherwise proceed to Step 6. **SEE THE ABOVE WARNING REGARDING HEALTH HAZARDS.**

MIL-STD-810H
METHOD 510.7

- Step 6. Stop the sand feed. Allow the chamber air temperature to return to standard ambient conditions at a rate not to exceed 3 °C/min (5 °F/min). Stabilize the test item temperature. Stop any air flow through the chamber.
- Step 7. Visually inspect the item looking for clogging effects, abrasion, and sand accumulation that may impede operation of the test item.
- Step 8. Photograph the sand accumulation on the test item.
- Step 9. Remove accumulated sand from the test item by using the methods anticipated to be used in service such as brushing, wiping, etc., taking care to avoid introduction of additional sand into the test item.
- Step 10. Visually inspect the test item looking for abrasion and clogging effects, and any evidence of sand penetration. Document the results.
- Step 11. Conduct an operational check of the test item in accordance with the approved test plan, and record results for comparison with pretest data. See paragraph 5.2 for analysis of results.

5. ANALYSIS OF RESULTS.**5.1 Blowing Dust Tests.**

In addition to the guidance provided in Part One, paragraphs 5.14 and 5.17, the following information is provided to assist in the evaluation of the test results. Analyze any failure of a test item to meet the requirements of the materiel specifications, and consider related information such as:

Determine if:

- a. Dust has penetrated the test item in sufficient quantity to cause binding, clogging, seizure or blocking of moving parts, non-operation contacts or relays, or the formation of electrically conductive bridges with resulting short circuits.
- b. Air filters are clogged restricting airflow.
- c. Abrasion of the test item exceeds the specified levels.
- d. The test item operates as required.

5.2 Blowing Sand Tests.

In addition to the guidance provided in Part One, paragraphs 5.14 and 5.17, the following information is provided to assist in the evaluation of the test results. Analyze any failure of a test item to meet the requirements of the materiel specifications, and consider related information such as, determine if:

- a. Abrasion of the test item exceeds the specified requirements.
- b. The test item operates as required.
- c. Protective coatings or seals were compromised.

6. REFERENCE/RELATED DOCUMENTS.**6.1 Referenced Documents.**

- a. Synopsis of Background Material for MIL-STD-210B, Climatic Extremes for Military Equipment, Bedford, MA: Air Force Cambridge Research Laboratories, January 1974. DTIC number AD-780-508.
- b. AR 70-38, Research, Development, Test and Evaluation of Materiel for Extreme Climatic Conditions.
- c. International Electrotechnical Commission (IEC) Publication 60068-2-68, Test L, Dust and Sand; IEC Website.
- d. MIL-HDBK-310, Global Climatic Data for Developing Military Products.
- e. Test Operations Procedure (TOP), 01-2-621 Outdoor Sand and Dust Testing, June 2009.
- f. ASTM D185-07, Standard Test Methods for Coarse Particles in Pigments, 2012.

MIL-STD-810H
METHOD 510.7

- g. MIL-STD-3033, Particle / Sand Erosion Testing of Rotor Blade Protective Materials, 28 July 2010.
- h. AMR-PS-08-01, Kinetic Energy Interceptor Flight Weather Encounter Requirements Development, November 2007.

6.2 Related Documents.

- a. NATO STANAG 4370, Environmental Testing.
- b. Allied Environmental Conditions and Test Publication (AECTP) 300, Climatic Environmental Tests (under STANAG 4370), Method 313.
- c. Egbert, Herbert W. "The History and Rationale of MIL-STD-810 (Edition 2)", January 2010; Institute of Environmental Sciences and Technology, Arlington Place One, 2340 S. Arlington Heights Road, Suite 100, Arlington Heights, IL 60005-4516.

(Copies of Department of Defense Specifications, Standards, and Handbooks, and International Standardization Agreements are available online at <https://assist.dla.mil>).

Requests for other defense-related technical publications may be directed to the Defense Technical Information Center (DTIC), ATTN: DTIC-BR, Suite 0944, 8725 John J. Kingman Road, Fort Belvoir VA 22060-6218, 1-800-225-3842 (Assistance--selection 3, option 2), <http://www.dtic.mil/dtic/>; and the National Technical Information Service (NTIS), Springfield VA 22161, 1-800-553-NTIS (6847), <http://www.ntis.gov/>.

MIL-STD-810H
METHOD 510.7

(This page is intentionally blank.)

MIL-STD-810H
METHOD 511.7**METHOD 511.7**
EXPLOSIVE ATMOSPHERE**CONTENTS**

<u>Paragraph</u>	<u>Page</u>
1. SCOPE	1
1.1 PURPOSE	1
1.2 APPLICATION	1
1.3 LIMITATIONS.....	1
2. TAILORING GUIDANCE	1
2.1 SELECTING THE EXPLOSIVE ATMOSPHERE METHOD.....	1
2.1.1 PROCEDURE I - EXPLOSIVE ATMOSPHERE	2
2.1.2 PROCEDURE II - EXPLOSION CONTAINMENT	2
2.1.3 EFFECTS OF EXPLOSIVE ATMOSPHERE ENVIRONMENTS.....	2
2.1.4 SEQUENCE AMONG OTHER METHODS.....	2
2.2 SELECTING PROCEDURE VARIATIONS	2
2.2.1 FUEL	2
2.2.2 FUEL-VAPOR MIXTURE.....	3
2.2.3 TEMPERATURE	4
2.2.4 EFFECT OF HUMIDITY ON FLAMMABLE ATMOSPHERE	4
2.2.5 ALTITUDE SIMULATION	4
2.3 DEFINITIONS	4
3. INFORMATION REQUIRED.....	5
3.1 PRETEST.....	5
3.2 DURING TEST.....	5
3.3 POST-TEST	5
4. TEST PROCESS	5
4.1 TEST FACILITY	5
4.2 CONTROLS	6
4.3 TEST INTERRUPTION	6
4.3.1 TEST INTERRUPTION DUE TO CHAMBER MALFUNCTION.....	6
4.3.2 TEST INTERRUPTION DUE TO TEST ITEM OPERATION FAILURE	6
4.4 TEST SETUP.....	6
4.5 TEST EXECUTION	6
4.5.1 PREPARATION FOR TEST.....	6
4.5.2 PROCEDURE I - OPERATION IN AN EXPLOSIVE ATMOSPHERE	7
4.5.3 PROCEDURE II - EXPLOSION CONTAINMENT	9
5. ANALYSIS OF RESULTS	10
6. REFERENCE/RELATED DOCUMENTS	10
6.1 REFERENCED DOCUMENTS.....	10
6.2 RELATED DOCUMENTS.....	10

MIL-STD-810H
METHOD 511.7

CONTENTS - Continued

<u>Paragraph</u>		<u>Page</u>
	FIGURES	
FIGURE 511.7 -1.	SPECIFIC GRAVITY OF N-HEXANE	4
FIGURE 511.7 -2.	TYPICAL REPRESENTATION OF PROCEDURE I CONDUCT	9

MIL-STD-810H
METHOD 511.7**METHOD 511.7**
EXPLOSIVE ATMOSPHERE

NOTE: Tailoring is essential. Select methods, procedures, and parameter levels based on the tailoring process described in Part One, paragraph 4.2.2, and Annex C. Apply the general guidelines for laboratory test methods described in Part One, paragraph 5 of this Standard.

1. SCOPE.**1.1 Purpose.**

The explosive atmosphere test is performed to either:

- a. Demonstrate the ability of materiel to operate in fuel-air explosive atmospheres without causing ignition.
- b. Demonstrate that an explosive or burning reaction occurring within encased materiel will be contained, and will not propagate outside the test item.

1.2 Application.

This Method applies to all materiel designed for use in the vicinity of fuel-air explosive atmospheres associated with aircraft, automotive, and marine fuels at or above sea level. The flammable/explosive vapors may originate either from the equipment itself or from an external source. Procedure II specifically relates to atmospheres in a space in which flammable fluids or vapors exist, or can exist, either continuously or intermittently (e.g., in fuel tanks or within fuel systems).

NOTE: Materiel tested to Procedure II is designed such that ignition of an explosive mixture is contained within the materiel without igniting the surrounding explosive atmosphere and, during normal operation, or as a result of any fault, the temperature of any external surface will not rise to a level capable of causing ignition (including hermetically-sealed materiel).

1.3 Limitations.

- a. These procedures use an explosive fuel-air mixture that has a relatively low flash point that may not be representative of some actual fuel-air or aerosol (such as suspended dust) mixtures.
- b. The explosive atmosphere test is a conservative test. If the test item does not ignite the test fuel-air mixture, there is a low probability that the materiel will ignite prevailing fuel vapor mixtures in service. Conversely, the ignition of the test fuel-air mixture by the test item does not mean the materiel will always ignite fuel vapors that occur in actual use.
- c. These procedures are not appropriate for test altitudes above approximately 16 km where the lack of oxygen inhibits ignition.
- d. While the Method is not intended to test for high surface temperatures, it does not preclude this possibility (this Method is intended for spark ignition).

2. TAILORING GUIDANCE.**2.1 Selecting the Explosive Atmosphere Method.**

After examining requirements documents and applying the tailoring process in Part One of this Standard to determine where explosive atmospheres are foreseen in the life cycle of the test item, use the following to confirm the need for this Method and to place it in sequence with other methods.

MIL-STD-810H
METHOD 511.7**2.1.1 Procedure I - Explosive Atmosphere.**

This procedure is applicable to all types of sealed and unsealed materiel. This test evaluates the ability of the test item to be operated in a fuel vapor environment without igniting the environment.

2.1.2 Procedure II - Explosion Containment.

This procedure is used to determine the ability of the test item's case or other enclosures to contain an explosion or flame that is a result of an internal materiel malfunction.

2.1.3 Effects of Explosive Atmosphere Environments.

Low levels of electrical energy discharge or electrical arcing by devices can ignite mixtures of fuel vapor and air. Fuel vapors in confined spaces can be ignited by a low energy discharge such as a spark from a short-circuited flashlight cell, switch contacts, electrostatic discharge, etc. High surface temperatures in excess of the auto-ignition temperature of flammable/explosive vapors may result in ignition of the vapors.

2.1.4 Sequence Among Other Methods.

- a. General. Use the anticipated life cycle sequence of events as a general sequence guide (see Part One, paragraph 5.5).
- b. Unique to this Method. Considering the approach to conserve test item life by applying what are perceived to be the least damaging environments first, generally apply the explosive atmosphere test late in the test sequence. Vibration, shock, and temperature stresses may distort seals and reduce their effectiveness, thus making ignition of flammable atmospheres more likely. Recommend the test item(s) first undergo the above tests (on the same item(s)) to better approximate the actual operational environment.

2.2 Selecting Procedure Variations.

Before conducting this test, complete the tailoring process by selecting specific procedure variations (special test conditions/techniques for this procedure) based on requirements documents, Life Cycle Environmental Profile (LCEP), and information provided with these procedures. Consider the following:

2.2.1 Fuel.

Unless otherwise specified, use n-hexane as the test fuel, either reagent grade or 95 percent n-hexane with 5 percent other hexane isomers. This fuel is used because its ignition properties in flammable atmospheres are equal to or more sensitive than the similar properties of 100/130-octane aviation gasoline, JP-4 and JP-8 jet engine fuel. Optimum mixtures of n-hexane and air will ignite from temperatures as low as 223 °C, while optimum JP-4 fuel-air mixtures require a minimum temperature of 230 °C for auto-ignition, and 100/130 octane aviation gasoline and air requires 441 °C for hot-spot ignition (see paragraph 1.3d). Minimum spark energy inputs for ignition of optimum fuel vapor and air mixtures are essentially the same for n-hexane and for 100/130-octane aviation gasoline. The minimum ignition energy for n-Hexane in air at standard atmospheric pressure is 0.29mJ. A much higher spark energy input is required to ignite JP-4 or JP-8 fuel-air mixtures. Use of fuels other than n-hexane is not recommended.

WARNING: N-hexane is the flammable liquid used to test products in an explosive atmosphere. This solvent is listed as a hazardous material under Section 313 of the Comprehensive Environmental Response, Compensation, and Liability Act (CERCLA) (paragraph 6.1, reference a). It is classified by the Clean Air Act as a hazardous air pollutant and a hazardous air contaminant, is a Class 3 hazardous material, and has been identified by the Occupational Safety and Health Administration (OSHA) as requiring a maximum permissible exposure limit. The current OSHA permissible exposure limit (PEL) for n-hexane is 500 parts per million (PPM) (in air at 25 °C (77 °F), 760 Torr) for an 8-hour workday, time weighted average (TWA). OSHA directs an individual shall not exceed this average level per an 8-hour period (workday) based on a 40-hour workweek. N-hexane does not have a specified ceiling limit (as established by OSHA). OSHA has not established a specific PEL for the other fuels listed above. These fuels, AvGas 100/130 octane, JP-4, and JP-8 are blends of various simple and complex organic compounds. In many cases, the fuel formulas can include chemical compounds identified in 29 CFR 1910-1000, Table Z-1 (paragraph 6.1, reference b). If a specific producer/product is consistently employed, the formula for

MIL-STD-810H
METHOD 511.7

this fuel blend can be analyzed and a specific warning prepared for the individual product. However, it should not be necessary, as the recommended chemical for the test is n-hexane.

2.2.2 Fuel-Vapor Mixture.

Use a homogeneous fuel-air mixture in the correct fuel-air ratios for the explosive atmosphere test. Fuel weight calculated to total 3.8 percent by volume of the test atmosphere represents 1.8 stoichiometric equivalents of n-hexane in air, giving a mixture needing only minimum energy for ignition. This yields an air/vapor ratio (AVR) of 8.33 by weight (paragraph 6.1, reference c).

- a. Required information to determine fuel weight:
 - (1) Chamber air temperature during the test.
 - (2) Fuel temperature.
 - (3) Specific gravity of n-hexane (see Figure 511.7-1).
 - (4) Test altitude: ambient ground or as otherwise identified.
 - (5) Net volume of the test chamber: free volume less test item displacement.
- b. Calculation of the volume of liquid n-hexane fuel for each test altitude:

- (1) In metric units:

Volume of 95 percent n-hexane (ml) =

$$(4.27 \times 10^{-4}) \left[\frac{(\text{net chamber vol (liters)}) \times (\text{chamber pressure (pascals)})}{(\text{chamber temp (K)}) \times (\text{specific gravity of n-hexane})} \right]$$

- (2) In English units:

Volume of 95 percent n-hexane (ml) =

$$(150.41) \left[\frac{(\text{net chamber vol (ft}^3\text{)}) \times (\text{chamber pressure (psia)})}{(\text{chamber temp (R)}) \times (\text{specific gravity of n-hexane})} \right]$$

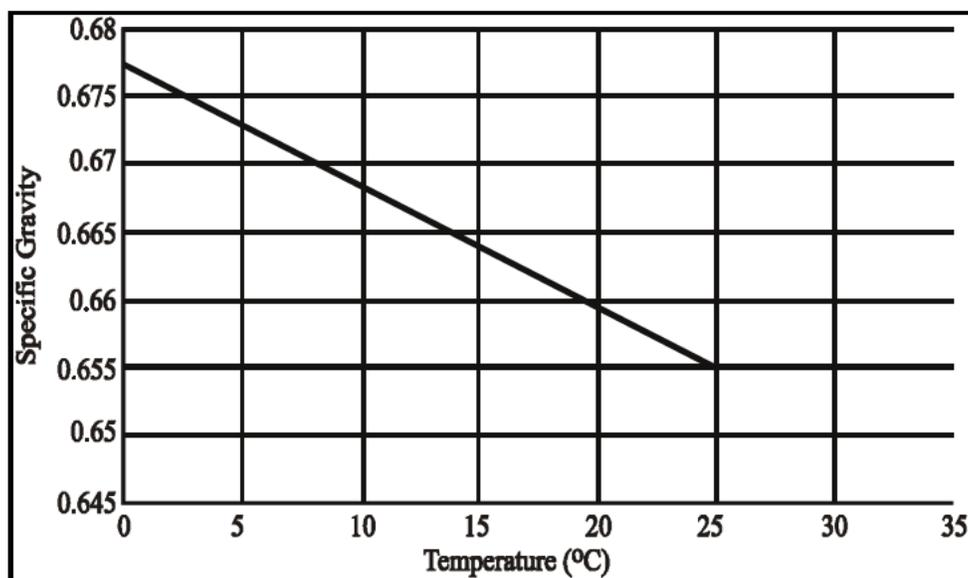
MIL-STD-810H
METHOD 511.7

Figure 511.7-1. Specific gravity of n-hexane.

2.2.3 Temperature.

Heat the fuel-air mixture to the highest ambient air temperature at which the materiel is required to operate during deployment and provide the greatest probability of ignition. Perform all testing at this maximum air temperature. For forced-air-cooled materiel, use a test temperature that is the highest temperature at which the materiel can be operated and performance evaluated in the absence of cooling air. Chamber air temperature is typically controlled by indirect heating such as heated chamber walls.

2.2.4 Effect of Humidity on Flammable Atmosphere.

The effect of humidity upon the fuel-air composition need not be considered in the test if the ambient air dewpoint temperature is 10 °C (50 °F) or less because this concentration of water vapor only increases the n-hexane fuel concentration from 3.82 percent to 3.85 percent of the test atmosphere. For example, if the atmospheric pressure is cycled from an equivalent of 1524 m (5000 ft) above the test level to 1524 m (5000 ft) below, (a 34 percent change in pressure), the volume of n-hexane will decrease from 4.61 percent to 3.08 percent. This decrease will compensate for the fuel enrichment effect that results from water vapor dilution of the test air supply. Tailoring may be required to simulate specific geographic areas.

2.2.5 Altitude Simulation.

This test evaluates whether a test item can operate safely in a fuel/air mixture without creating a spark that could ignite the atmosphere. Since the components used in certain test items may make them more susceptible to creating sparks at high altitudes, all items must be tested up to their maximum operating altitude. The energy required to ignite a fuel-air mixture increases as pressure decreases. Ignition energy does not drop significantly for test altitudes below sea level. Therefore, unless otherwise specified, perform all tests with at least two explosive atmosphere steps, one at the highest anticipated operating altitude of the materiel (not to exceed 12,200 m (40,000 ft) where the possibility of an explosion begins to dissipate), and one between 7,000 ft and -1,500 ft (11.3 and 15.5 psi) that is representative of most ground ambient pressures. As noted in paragraph 1.3, because of the lack of oxygen at approximately 16 km (9.94 miles), do not perform this test at or above this altitude.

2.3 Definitions.

For the purpose of this Method, the following definitions apply:

- a. **Simulated altitude.** Any height that is produced in the test chamber by reducing air pressure.
- b. **Test altitude.** The nominal simulated height(s) (generally, above sea level) at which the test item will be tested, i.e., the maximum altitude identified in paragraph 2.2.5.

MIL-STD-810H
METHOD 511.7**3. INFORMATION REQUIRED****3.1 Pretest.**

The following information is required to conduct explosive atmosphere tests adequately.

- a. General. Information listed in Part One, paragraphs 5.7 and 5.9, and Annex A, Task 405 of this Standard.
- b. Specific to this Method.
 - (1) Additional test altitudes (other than the maximum operating altitude and site pressure).
 - (2) The fuel volume and/or weight.
 - (3) Calculation for the quantity of fuel required at each test altitude.
 - (4) The off/on cycling rate for the test item.
 - (5) Any information relative to the location of spark-emitting devices or high temperature components.
- c. Tailoring. Necessary variations in the basic test procedures to accommodate environments identified in the LCEP.

3.2 During Test.

Collect the following information during conduct of the test:

- a. General. Information listed in Part One, paragraph 5.10, and in Annex A, Tasks 405 and 406 of this Standard.
- b. Specific to this Method.
 - (1) Periods of operation versus test altitude (on/off points).
 - (2) Quantity of fuel introduced for each test altitude.
 - (3) Occurrence of any explosion caused by the test item and the respective altitude and temperature at which the event occurred.

3.3 Post-Test.

The following post test data shall be included in the test report.

- a. General. See Part One, paragraph 5.13; and Annex A, Task 406.
- b. Specific to this Method.
 - (1) Chamber test altitude and temperature for each operational check.
 - (2) Occurrence of any explosion caused by the test item.
 - (3) Initial analysis of any failures/problems.
 - (4) Any deviation from the original test plan.
 - (5) Test item temperature for each operational check.

4. TEST PROCESS.**4.1 Test Facility.**

The required apparatus consists of a chamber or cabinet, together with auxiliary instrumentation, capable of establishing, maintaining and monitoring (see Part One, paragraph 5.18) the specified test conditions. Use a chamber with a means of determining the explosiveness of a sample of the mixture, such as a spark gap or glow plug ignition source with sufficient energy to ignite a 3.82 percent hexane mixture. An alternative method of determining the explosive characteristics of the vapor is by using a calibrated explosive gas meter that verifies the degree of explosiveness and the concentration of the fuel-air mixture. Chamber air temperature is typically controlled by indirect heating such as heated chamber walls. Due to varying geographic facility locations and differences in site pressure, it is highly recommended that the chamber has the capability to reach 1000 ft (14.17 psia) or below for the low altitude portion of the test. The minimum ignition energy varies inversely with the square of the pressure. Due to the change in ignition energy between sea level (14.7 psia) and 7,000 ft (11.3 psia) it is possible for the equipment under test to

MIL-STD-810H
METHOD 511.7

pass at 11.3 psia, whereas it may have failed if tested at pressures nearer 14.7 psia. The minimum ignition energy at 1000 ft (14.17 psia) is within 5 percent of the optimum at sea level.

4.2 Controls.

Before each test, verify the critical parameters. Ensure spark devices function properly and the fuel atomizing system is free from deposits that could inhibit proper functioning. Adjust the empty test chamber to the highest test altitude, shut off the vacuum system and measure the rate of any air leakage. Verify that any leakage is not sufficient to prevent the test from being performed as required, i.e., introduce the test fuel and wait three minutes for full vaporization, yet still be at least 1000 m above the test altitude.

4.3 Test Interruption.

Test interruptions can result from two or more situations, one being from failure or malfunction of test chambers or associated test laboratory equipment. The second type of test interruption results from failure or malfunction of the test item itself during required or optional performance checks.

4.3.1 Test Interruption Due To Chamber Malfunction.

- a. General. See Part One, paragraph 5.11 of this Standard.
- b. Specific to this Method. If there is an unscheduled undertest interruption, restore the chamber air pressure to ground ambient pressure and purge the chamber to remove the flammable atmosphere. Achieve the required test altitude, inject the required volume of n-hexane and reinitiate the test using the same test item.

4.3.2 Test Interruption Due To Test item Operation Failure.

Failure of the test item(s) to function as required during mandatory or optional performance checks during testing presents a situation with several possible options.

- a. The preferable option is to replace the test item with a “new” one and restart from Step 1.
- b. A second option is to replace / repair the failed or non-functioning component or assembly with one that functions as intended, and restart the entire test from Step 1.

<p>NOTE: When evaluating failure interruptions, consider prior testing on the same test item and consequences of such.</p>

4.4 Test Setup.

- a. General. See Part One, paragraph 5.8.
- b. Unique to this Method. For test item thermal stabilization measurements for both procedures, install thermocouples on the most massive functional part of the test item, and two thermocouples attached to the inside the of test chamber to detect any temperature increase due to burning of the mixture.

4.5 Test Execution.

The following steps, alone or in combination, provide the basis for collecting necessary information concerning the materiel in an explosive atmosphere.

4.5.1 Preparation for Test.

Before starting the test, review pretest information in the test plan to determine test details (e.g., procedures, test item configuration, test temperature, test altitude, etc.).

- a. Procedure I - Operation in an Explosive Atmosphere.
 - (1) Install the test item in the test chamber in such a manner that it may be operated and controlled from the exterior of the chamber via sealed cable ports. Unless permanently sealed (not to be opened for maintenance or other purposes), remove or loosen the external covers of the test item to facilitate the penetration of the explosive mixture. Test items requiring connection between two or more units may,

MIL-STD-810H
METHOD 511.7

because of size limitations, have to be tested independently. In this case, extend any interconnections through the cable ports.

- (2) Operate the test item to verify correct remote operation. If possible, identify the location of any sparking components that could cause an explosion. If required, conduct a thermal survey to determine the temperature of components or areas/surfaces that may be potential hot spots. If the test item operates satisfactorily, proceed to paragraph 4.5.2 or 4.5.3 as appropriate. If not, resolve the problems and repeat this Step.
- (3) When necessary, simulate in-service mechanical loads on drive assemblies and servo-mechanical systems, and electrical loads on switches and relays; duplicate torque, voltage, current, inductive reactance, etc. In all instances, operate the test item in a manner representative of service use.

b. Procedure II - Explosion Containment.

- (1) Make provision to circulate the fuel-air mixture into the case being tested. In the case of forced-air-cooled materiel, the cooling air must contain the proper fuel-air mixture. For materiel not using forced-air cooling, drill and tap the case for insertion of a hose from a blower (to insert the fuel-air mixture), as well as for an outlet hose connection. Take adequate precautions to prevent ignition of the ambient mixture by backfire or release of pressure through the supply or vent hose. Do not alter the case internal volume by more than ± 5 percent with any modification to facilitate the introduction of ignitable vapor.
- (2) Provide a positive means of igniting the explosive mixture within the case. Drill or tap the case as necessary for a spark gap, or mount a spark gap internally. Ensure points of ignition are not be more than 1.27 cm (0.5 inch) from any vent holes or flame arresting devices; and, unless the design of the materiel makes this impractical, use as many points of ignition as are practical.
- (3) To detect explosions within the case, insert a thermocouple into the case, and attach it to a sensitive galvanometer outside the test chamber.
- (4) Ensure the air within the test chamber has a water vapor dew point lower than 10 °C (50 °F) per paragraph 2.2.4.

4.5.2 Procedure I - Operation in an Explosive Atmosphere.

- Step 1 Figure 511.7-2 contains a visual representation of typical test conduct. Test altitudes should be tailored to the individual item requirements. With the test item installed, seal the chamber and stabilize the test item and chamber air temperature to the high operating temperature of the test item (± 2 °C (± 3.6 °F)) for a minimum duration of one hour. Monitor the chamber wall temperature and chamber air temperature throughout the duration of test to ensure uniform heating. Excessive chamber wall temperature could adversely affect the test item.
- Step 2 Adjust the chamber air pressure to simulate the highest operating altitude of the test item (not to exceed 12,200 m (40,000 ft)) plus 2000 m (6600 ft) to allow for introducing, vaporizing, and mixing the fuel with the air as described in paragraph 2.2.2.
- Step 3 Slowly introduce the required volume of n-hexane into the test chamber and begin reducing the simulated altitude at a rate no faster than 100 m (330 ft) per minute.
- Step 4 Circulate the test atmosphere and continue to reduce the simulated chamber altitude for at least three minutes to allow for complete vaporization of fuel and the development of a homogeneous mixture, and for the chamber pressure to reach the test altitude.
- Step 5 At a pressure equivalent to 1000 m (3300 ft) above the test altitude, verify the potential explosiveness of the fuel-air vapor by attempting to ignite a sample of the mixture taken from the test chamber using a spark-gap device or glow plug ignition source with sufficient energy to ignite a 3.82 percent hexane mixture. If ignition does not occur, purge the chamber of the fuel vapor and repeat Steps 1-4. An alternative method of determining the explosive characteristics of the vapor is by using a calibrated explosive gas meter that verifies the degree of explosiveness and the concentration of the fuel-air mixture.

MIL-STD-810H
METHOD 511.7

- Step 6 Although above the maximum operational altitude of the test item, attempt to operate the test item, making and breaking electrical contacts, such as switches, mechanical relays, and connectors as often as possible for minimum of three power/operational cycles. Continue operation from this step until completion of Step 8. Note the altitude at which the test item begins proper operation. If the test item fails to operate as intended, follow the guidance in paragraph 4.3.2 for test item failure.
- Step 7 To ensure adequate mixing of the fuel and air, slowly decrease the simulated chamber altitude at a rate no faster than 100 m (330 ft) per minute by bleeding air into the chamber.
- Step 8 Stop decreasing the altitude at 1000 m (3300 ft) below the test altitude or at ground level, whichever is reached first, and perform an operational check, and switch off power to the test item. If the test item fails to operate as intended, follow the guidance in paragraph 4.3.2 for test item failure.
- Step 9 Verify the potential explosiveness of the air-vapor mixture as in Step 5 above. If ignition does not occur, purge the chamber of the fuel vapor, and repeat the test from Step 1.
- Step 10 Adjust the simulated chamber altitude to the equivalent of 2000 m (6600 ft) above site pressure.
- Step 11 Slowly introduce the required volume of n-hexane into the test chamber and begin reducing the simulated altitude at a rate no faster than 100 m (330 ft) per minute. (Note: In calculating the fuel volume to be added, providing the chamber has not been purged, subtract the volume introduced in Step 3 to maintain the proper fuel-air mixture.).
- Step 12 Circulate the test atmosphere for at least three minutes to allow for complete vaporization of fuel and the development of a homogeneous mixture, and for the chamber pressure to reach the test altitude.
- Step 13 At a pressure equivalent to 1000 m (3300 ft) above the site pressure, verify the potential explosiveness of the fuel-air vapor by attempting to ignite a sample of the mixture taken from the test chamber using a spark-gap device or glow plug ignition source with sufficient energy to ignite a 3.82 percent hexane mixture. If ignition does not occur, purge the chamber of the fuel vapor and repeat Steps 10-13. An alternative method of determining the explosive characteristics of the vapor is by using a calibrated explosive gas meter that verifies the degree of explosiveness and the concentration of the fuel-air mixture.
- Step 14 Attempt to operate the test item and continue operation from this step until completion of Step 16. Make and break electrical contacts, such as switches, mechanical relays, and connectors as often as possible for minimum of three power/operational cycles. Note whether the test item resumes proper operation. If the test item fails to operate as intended, follow the guidance in paragraph 4.3.2 for test item failure.
- Step 15 To ensure adequate mixing of the fuel and air, slowly decrease the simulated chamber altitude at a rate no faster than 100 m (330 ft) per minute by bleeding air into the chamber.
- Step 16 At site pressure, perform one last operational check and switch-off power to the test item. If required, ensure the test item temperature has stabilized (in accordance with Part One paragraph 5.4.1) prior to conducting the final operational check.
- Step 17 Verify the potential explosiveness of the air-vapor mixture as in Step 5, above. If ignition does not occur, purge the chamber of the fuel vapor, and repeat the test from Step 10.
- Step 18 Adjust the chamber to standard ambient conditions and document the test results. See paragraph 5 of this Method for analysis of results.

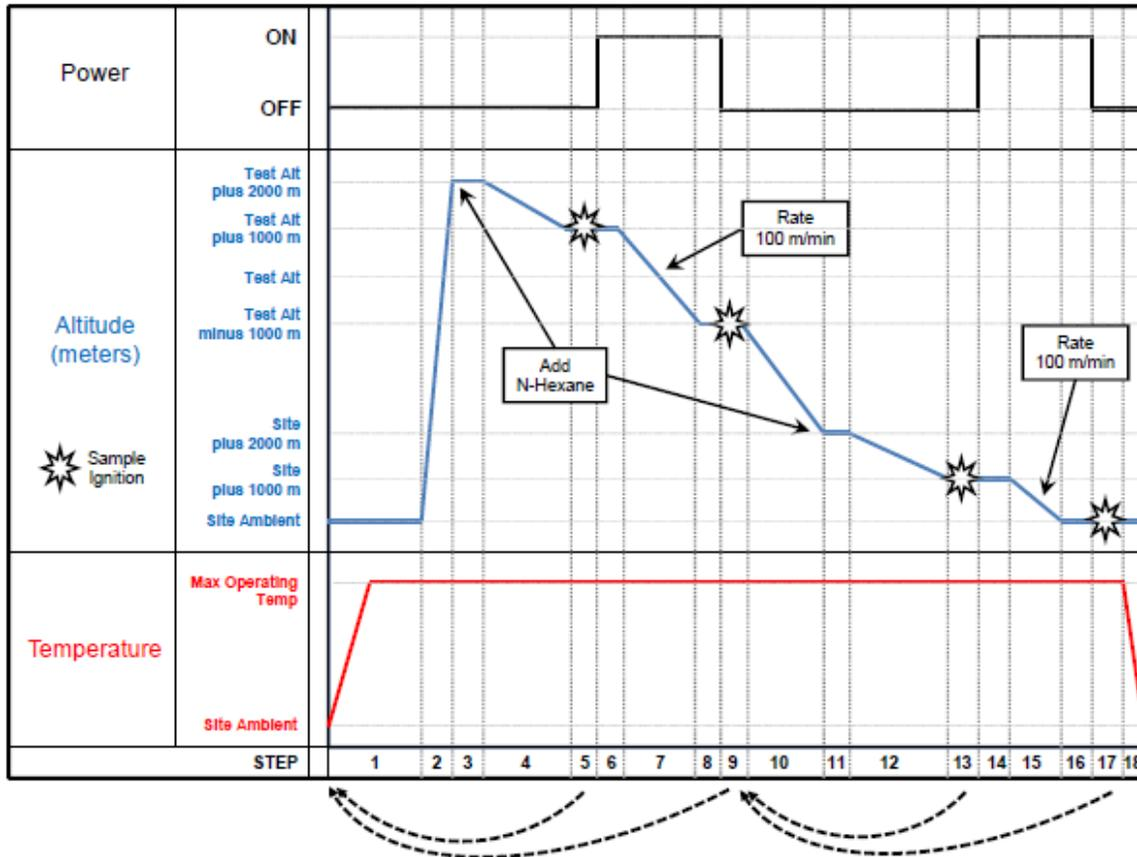
MIL-STD-810H
METHOD 511.7

Figure 511.7-2. Typical representation of Procedure I conduct.

4.5.3 Procedure II - Explosion Containment.

- Step 1 Place the test item or a model of the test item of the same volume and configuration within the case, and install the case in the explosion chamber.
- Step 2 Ensure the air within the test chamber has a water vapor dew point lower than 10 °C (50 °F) per paragraph 2.2.4.
- Step 3 Seal the chamber with the test item inside, and raise the chamber air temperature to the high operating temperature of the test item.
- Step 4 When the temperature of the both the test item and the test chamber inner walls come to within 11 °C (20 °F) of the chamber air temperature, reduce the chamber air pressure to 2000 m (6600 ft) of simulated altitude above the site ambient pressure (i.e., ground level).
- Step 5 Slowly introduce the required quantity of n-hexane into the test chamber to obtain an optimum fuel-vapor/air mixture, and then introduce it into the interior of the test item.
- Step 6 Slowly decrease the simulated chamber altitude (no faster than 100 m (330 ft) per minute) to return the pressure altitude to site pressure (i.e., ground level).
- Step 7 Energize the internal case ignition source and confirm the occurrence of an explosion within the test item using the installed thermocouple. If no explosion occurs, purge the chamber and the test item of all air/fuel vapor and return to Step 3.

MIL-STD-810H
METHOD 511.7

- Step 8 If an explosion does occur inside the test item's case and did not propagate to the fuel/air mixture outside the test item, repeat Steps 4-10 four times if the test item's case is not in excess of 0.02 times the chamber volume. If the test item volume is equal to or greater than 0.02 times the chamber volume, purge the chamber and test item of air/fuel vapor and repeat Steps 3-10 four times.
- Step 9 Check the potential explosiveness of the air/fuel vapor mixture by attempting to ignite a sample of the mixture by a spark or glow plug. If the chamber sample does not ignite, purge the chamber of all air/fuel vapor mixture, and repeat the entire test from Step 3.
- Step 10 Document the test results. See paragraph 5 of this Method for analysis of results.

5. ANALYSIS OF RESULTS.

In addition to the guidance provided in Part One, paragraphs 5.14 and 5.17, ignition of test fuel vapor constitutes test item failure. For Procedure II, propagation of flame to, or ignition of, a flammable atmosphere surrounding the test item when the test atmosphere within the enclosure or case of the test item is intentionally ignited constitutes failure of the test. Apply any data relative to failure of a test item to meet the requirements of the materiel specifications to the test analysis.

6. REFERENCE/RELATED DOCUMENTS.

6.1 Referenced Documents.

- a. Section 313 of the Comprehensive Environmental Response, Compensation, and Liability Act (CERCLA); Air Force Institute of Technology/Air Force Research Laboratory Library.
- b. Code of Federal Regulations 29 CFR 1910-1000, Air Contaminants, Table Z-1; Occupational Safety & Health Administration Website.
- c. Combustion Fundamentals, Roger A. Strehlow, McGraw Hill Book Co.

6.2 Related Documents.

- a. Egbert, Herbert W. "The History and Rationale of MIL-STD-810 (Edition 2)", January 2010; Institute of Environmental Sciences and Technology, Arlington Place One, 2340 S. Arlington Heights Road, Suite 100, Arlington Heights, IL 60005-4516.
- b. Haskin, W.L., Explosion-Proof Testing Techniques. 1963. ASD-TDR-62-1081. DTIC number AD-400-483.
- c. Zabetakis, M.G., A.L. Furno, and G.W. Jones. "Minimum Spontaneous Ignition Temperatures of Combustibles in Air", Industrial and Engineering Chemistry 46 (1954), 2173-2178.
- d. Washburn, E.W., ed. International Critical Tables of Numerical Data. Chemistry and Technology. Vol. III. New York: National Research Council/McGraw-Hill, 1928. pp 27-29.
- e. Kuchta, J.M. Summary of Ignition Properties of Jet Fuels and Other. 1975. AFAPL-TR-75-70, pp 9-14. DTIC number AD-A021-320.
- f. ASTM E 380-79. Standard for Metric Practice.
- g. Allied Environmental Conditions and Test Publication (AECTP) 300, Climatic Environmental Tests (under STANAG 4370), Method 316.

(Copies of Department of Defense Specifications, Standards, and Handbooks, and International Standardization Agreements are available online at <https://assist.dla.mil>.)

Requests for other defense-related technical publications may be directed to the Defense Technical Information Center (DTIC), ATTN: DTIC-BR, Suite 0944, 8725 John J. Kingman Road, Fort Belvoir VA 22060-6218, 1-800-225-3842 (Assistance--selection 3, option 2), <http://www.dtic.mil/dtic/>; and the National Technical Information Service (NTIS), Springfield VA 22161, 1-800-553-NTIS (6847), <http://www.ntis.gov/>.

MIL-STD-810H
METHOD 512.6**METHOD 512.6****IMMERSION****CONTENTS**

<u>Paragraph</u>	<u>Page</u>
1. SCOPE	1
1.1 PURPOSE	1
1.2 APPLICATION	1
1.3 LIMITATIONS.....	1
2. TAILORING GUIDANCE	1
2.1 SELECTING THE IMMERSION METHOD.....	1
2.1.1 EFFECTS OF LEAKAGE DURING IMMERSION.....	1
2.1.2 SEQUENCE AMONG OTHER METHODS.....	1
2.2 SELECTING PROCEDURES	2
2.2.1 PROCEDURE SELECTION CONSIDERATIONS	2
2.2.2 DIFFERENCE BETWEEN PROCEDURES	2
2.3 DETERMINE TEST LEVELS AND CONDITIONS	2
2.3.1 IDENTIFY CLIMATIC CONDITIONS	2
2.3.2 DETERMINE EXPOSURE CONDITIONS	2
2.3.2.1 TEST ITEM CONFIGURATION	2
2.3.2.2 CONDITIONING TEMPERATURE	3
2.3.2.3 DEPTH OF IMMERSION.....	3
2.3.2.4 DEPTH OF FORDING.....	3
2.3.2.5 MATERIEL FORDING.....	4
2.3.2.6 DURATION OF IMMERSION EXPOSURE.....	4
3. INFORMATION REQUIRED.....	4
3.1 PRETEST.....	4
3.2 DURING TEST.....	4
3.3 POST-TEST	5
4. TEST PROCESS	5
4.1 TEST FACILITY	5
4.2 CONTROLS	5
4.3 TEST INTERRUPTION	5
4.3.1 TEST INTERRUPTION DUE TO CHAMBER MALFUNCTION	5
4.3.2 TEST INTERRUPTION DUE TO TEST ITEM OPERATION FAILURE	5
4.4 TEST EXECUTION	6
4.4.1 PREPARATION FOR TEST.....	6
4.4.1.1 PRELIMINARY STEPS	6
4.4.1.2 PRETEST STANDARD AMBIENT CHECKOUT.....	6
4.4.2 PROCEDURE I - IMMERSION.....	6
4.4.3 PROCEDURE II - FORDING	7
5. ANALYSIS OF RESULTS	7
6. REFERENCE/RELATED DOCUMENTS	7
6.1 REFERENCED DOCUMENTS.....	7
6.2 RELATED DOCUMENTS.....	7

MIL-STD-810H
METHOD 512.6

(This page is intentionally blank.)

MIL-STD-810H
METHOD 512.6**METHOD 512.6**
IMMERSION

NOTE: Tailoring is essential. Select methods, procedures, and parameter levels based on the tailoring process described in Part One, paragraph 4.2.2, and Annex C. Apply the general guidelines for laboratory test methods described in Part One, paragraph 5 of this Standard.

1. SCOPE.**1.1 Purpose.**

The immersion test is performed to determine if materiel can withstand immersion or partial immersion in water (e.g., fording), and operate as required during or following immersion.

1.2 Application.

Use this Method for materiel that may be exposed to partial or complete immersion, with or without operation. This test may, in some cases, be used to verify watertightness in lieu of a rain test, provided the materiel configuration would be the same for both situations, and the method of water ingress is well understood. There are documented situations in which the impact of rain causes pumping of water across seals during the rain test that does not occur when seals are held tight against a backing plate by the static pressure of the immersion test. In most cases, both tests should be performed.

1.3 Limitations.

Immersion tests are not intended to be used for buoyant items unless the life cycle profile identifies specific applications such as restraints (including palletized loads) that could hold the materiel under water.

2. TAILORING GUIDANCE.**2.1 Selecting the Immersion Method.**

After examining requirements documents and applying the tailoring process in Part One of this Standard to determine where immersion or fording is anticipated in the life cycle of materiel, use the following to confirm the need for this Method and to place it in sequence with other methods.

2.1.1 Effects of Leakage During Immersion.

Penetration of water into materiel or packaging enclosures can result in problems. Consider the following typical problems to help determine if this Method is appropriate for the materiel being tested. This list is not intended to be all-inclusive.

- a. Fouling of lubricants between moving parts.
- b. Formation of electrically conductive paths that may cause electrical or electronic equipment to malfunction or become unsafe to operate.
- c. Corrosion due to direct exposure to the water or to the relatively high humidity levels caused by the water.
- d. Impairment of the burning qualities of explosives, propellants, fuels, etc.
- e. Failure of vehicle engines to operate.

2.1.2 Sequence Among Other Methods.

- a. General. Use the anticipated life cycle sequence of events as a general sequence guide (see Part One, paragraph 5.5).

MIL-STD-810H
METHOD 512.6b. Unique to this Method.

- (1) There are at least two philosophies related to test sequence. One approach is to conserve test item life by applying what are perceived to be the least damaging environments first. For this approach, generally apply the immersion test prior to most other climatic tests.
- (2) Another approach is to apply environments to maximize the likelihood of disclosing sequential problems. For this approach, consider the immersion test both before and after structural tests such as shock and vibration to aid in determining the test item's resistance to dynamic tests.

2.2 Selecting Procedures.

This Method includes two test procedures, Procedure I (Immersion) and Procedure II (Fording). Determine the procedure(s) to be used.

2.2.1 Procedure Selection Considerations.

When selecting procedures, consider:

- a. The operational purpose of the materiel. From the requirements documents, determine the functions to be performed by the materiel when partially or completely immersed in water.
- b. The natural exposure circumstances.
- c. The test data required to determine whether the operational purpose of the materiel has been met.

2.2.2 Difference Between Procedures.

While both procedures involve some degree of immersion, they differ in that Procedure I (Immersion) primarily addresses leakage during immersion of encased materiel, while Procedure II (Fording) focuses on vehicles traversing a body of water or materiel secured to such vehicles.

2.3 Determine Test Levels and Conditions.

Having selected this Method and relevant procedures (based on the materiel's requirements documents and the tailoring process), it is necessary to complete the tailoring process by selecting specific parameter levels and special test conditions/techniques for these procedures based on requirements documents, Life Cycle Environmental Profile (LCEP), and information provided with this procedure. From these sources of information, determine the functions to be performed by the materiel while immersed or following exposure to immersion. Then, determine the depth and duration of immersion anticipated in areas in which the materiel is designed to be employed. To do this, consider the following in light of the operational purpose and life cycle of the materiel.

2.3.1 Identify Climatic Conditions.

Identify the appropriate climatic conditions for the geographic areas in which the materiel will be operated and stored, and whether or not test item needs to be operated during the test.

2.3.2 Determine Exposure Conditions.

Base the specific test conditions on field data if available. In the absence of field data, determine the test conditions from the applicable requirements documents. If this information is not available, use the following guidance:

2.3.2.1 Test Item Configuration.

Use a test item configuration that reproduces, as close as possible, the anticipated materiel configuration during storage or use, such as:

- a. Enclosed in a shipping/storage container or transit case.
- b. Protected or unprotected.
- c. Deployed realistically or with restraints, such as with openings that are normally covered.

MIL-STD-810H
METHOD 512.6

2.3.2.2 Conditioning Temperature.

Experience has shown that a temperature differential between the test item and the water can affect the outcome (leakage) of an immersion test. The temperature of the water shall be $18\text{ }^{\circ}\text{C} \pm 10\text{ }^{\circ}\text{C}$ ($64\text{ }^{\circ}\text{F} \pm 18\text{ }^{\circ}\text{F}$). Increasing the test item temperature above the water temperature for the immersion test (Procedure I) usually includes heating of the test item to establish a pressure differential (while cooling) to determine if the seals or gaskets leak under relatively low pressure differential, and to induce expansion/contraction of materials. Although desired, establishing a specific temperature differential for fording tests is often impractical due to the size of the materiel. Also, consider materiel adjacent to heat-producing equipment such as engines, and use temperatures indicative of actual exposure.

- a. Unless otherwise identified, three options are provided for the conditioning of the test item:
 - (1) $27\text{ }^{\circ}\text{C}$ ($49\text{ }^{\circ}\text{F}$) above the water temperature - to represent exposure to solar heating immediately prior to immersion.
 - (2) $10\text{ }^{\circ}\text{C}$ ($18\text{ }^{\circ}\text{F}$) above the water temperature - to represent a typical temperature difference between materiel and water.
 - (3) Equal to the water temperature - to represent situations in which little or no temperature differential exists. This may be used for large items for which adequate conditioning facilities are not available, provided the depth of immersion is adjusted to result in the same differential pressure.
- b. Recommend the duration of conditioning immediately prior to immersion be at least two hours to ensure maximum heat loss during immersion and cooling.

2.3.2.3 Depth of Immersion.

- a. Complete immersion. For testing the integrity of a test item, use a 1 m covering depth of water or to the required depth as identified in the LCEP or the requirements document (measured from the uppermost surface of the test item to the surface of the water). When testing to depths greater than 1 m within a pressure vessel, it is required to completely immerse the test item in water and then apply the required pressure. The relevant depth/pressure equation follows:

$$P = 9.8d \text{ (fresh water)}$$

$$P = 10.045d \text{ (salt water)}$$

Where:

d = depth of the water in meters

P = pressure in kPa (1 psi = 6.895 kPa).

NOTE: When testing to depths greater than 1 m, within a pressure vessel, the volume of water shall continue to surround the test item throughout the test. The equivalent head of sea water is 0.975 times the head of fresh water for the same pressure difference.

- b. Partial immersion. Where materiel is unlikely to be completely immersed either due to anticipated water depths or to its ability to float, and being unlikely to be restrained, a partial immersion test may be appropriate. In this case, specify depths as being measured from the base of the materiel rather than from the top.

2.3.2.4 Depth of Fording.

The fording test may also be used to cover the requirements of STANAG 2805 (paragraph 6.1, reference a), that specifies the following depths.

- a. Shallow fording.
 - (1) Tanks and armored cars:
 - (a) Light tanks and armored cars – 1 m (39.4 in.).

MIL-STD-810H
METHOD 512.6

- (b) Other tanks (slightly more ground compression) - 1.05 m (41.3 in.).
- (2) Vehicles under 2 ton payload - 0.5 m (19.7 in.).
- (3) Other vehicles - 0.75 m (29.5 in.).
- b. Deep fording. It is essential that all tactical vehicles and guns, either with built-in waterproofing or by the use of waterproofing kits, be able to deep ford six (6) minutes in fresh or salt water to the depths indicated below (the depth to take into account ramp angle as well as wave height):
 - (1) Fully enclosed armored vehicles should be able to deep ford to the top of the turret. (Alternatively, these vehicles are to be fitted with flotation equipment.)
 - (2) All other prime movers or self propelled guns, except trailed loads, should be able to deep ford 1.5 m (59 in.).
 - (3) All trailers or towed guns should be capable of complete immersion. (Alternatively, this materiel should be capable of flotation.)

2.3.2.5 Materiel Fording.

Materiel designed to be transported on open vehicles and trailers (such as equipment trailers) should be capable of withstanding partial immersion as anticipated during fording exercises. Examples of fording depths for this type of materiel are as follow:

- a. S-280 shelter: 53 cm (21 inches).
- b. S-250 shelter: 76 cm (30 inches).

2.3.2.6 Duration of Immersion or Exposure.

Use a duration of immersion typical of that anticipated during use. If this duration is unknown, a 30-minute immersion period is considered adequate to develop leakage if it is to occur. Use one hour fording durations (other than as specified in paragraph 2.3.2.2) that may be extended if justified by the anticipated life cycle profile.

3. INFORMATION REQUIRED.

3.1 Pretest.

The following information is required to conduct immersion/fording tests adequately.

- a. General. Information listed in Part One, paragraphs 5.7 and 5.9; and Annex A, Task 405 of this Standard.
- b. Specific to this Method.
 - (1) Water temperature.
 - (2) The temperature to which to heat the test item (above the water temperature) and duration.
 - (3) The fording/immersion depths.
 - (4) The immersion durations.
 - (5) Tiedown precautions (to prevent unrealistic stress).
- c. Tailoring. Necessary variations in the basic test procedures to accommodate environments identified in the LCEP.

3.2 During Test.

Collect the following information during conduct of the test:

- a. General. Information listed in Part One, paragraph 5.10; and in Annex A, Tasks 405 and 406 of this Standard.
- b. Specific to this Method.
 - (1) Location of any bubbles (indicating leaks).
 - (2) Water temperature 15 minutes following immersion.

MIL-STD-810H
METHOD 512.6**3.3 Post-Test.**

The following post test data shall be included in the test report.

- a. General. Information listed in Part One, paragraph 5.13; and in Annex A, Task 406 of this Standard.
- b. Specific to this Method.
 - (1) Pretest water and test item temperatures.
 - (2) Quantity of any free water found inside the test item and probable point(s) of entry.
 - (3) Actual covering depth of water.
 - (4) Duration of immersion.
 - (5) Any deviations from the original test plan.
 - (6) Photographs as appropriate.

4. TEST PROCESS.**4.1 Test Facility.**

- a. For immersion tests, in addition to a chamber or cabinet capable of conditioning the test item to the required temperature, use a water container that can achieve a covering depth of 1 m (or other required depth) of water over the uppermost point of the test item and maintain the test item at that depth. To represent greater depths, it may be necessary to apply air pressure to the surface of the water.
- b. For fording tests, use a facility equipped with a tie-down capability to prevent buoyant test items from floating.
- c. A water soluble dye such as fluorescein may be added to the water to aid in locating water leaks.

4.2 Controls.

Before each test, verify the critical parameters. Ensure the immersion test pull-down/hold-down device(s) are functioning properly and that there are no safety problems.

4.3 Test Interruption.

Test interruptions can result from two or more situations, one being from failure or malfunction of test chambers or associated test laboratory equipment. The second type of test interruption results from failure or malfunction of the test item itself during operational checks.

4.3.1 Interruption Due To Chamber Malfunction.

- a. General. See Part One, paragraph 5.11 of this Standard.
- b. Specific to this Method.
 - (1) Undertest interruption. Treat an interruption that results in less severe conditions than specified as an invalid test. Dry the test item and repeat the entire test procedure from the beginning. Treat any failure discovered during an undertest condition as a failure.
 - (2) Overtest interruption. If more severe conditions than intended are applied and a failure results, repeat the test, if possible, on a replacement item. If no failure occurs, the test need not be repeated.

4.3.2 Interruption Due To Test Item Operation Failure.

Failure of the test item(s) to function as required during operational checks presents a situation with several possible options.

- a. The preferable option is to replace the test item with a “new” one and restart from Step 1.
- b. A second option is to replace / repair the failed or non-functioning component or assembly within the test item with one that functions as intended, and restart the entire test from Step 1.

MIL-STD-810H
METHOD 512.6

NOTE: When evaluating failure interruptions, consider prior testing on the same test item, and the consequences of such.

4.4 Test Execution.

The following steps, alone or in combination, provide the basis for collecting necessary information concerning the test item when partially or completely immersed in water.

4.4.1 Preparation for Test.

4.4.1.1 Preliminary Steps.

Before starting the test, review pretest information in the currently approved test plan to determine test details (e.g., procedures, item configuration, cycles, durations, parameter levels for storage/operation, etc.). (See paragraph 3.1 above.)

NOTE: Do not use sealing, taping, caulking, etc., except as required in the design specification for the materiel.

- a. If possible, when testing a shipping/storage container or transit case without the test items enclosed, remove all dunnage, packing, padding material, etc., that may absorb water before the test so that leakage can be detected. This option may not provide an adequate test of the container if the seals are not representatively stressed because of the absence of the contents.
- b. Secure items that may experience immersion when mounted on, or secured to a carrying platform, representatively. If representative of the real life situation, stacking is an acceptable method of restraining items under water.

4.4.1.2 Pretest Standard Ambient Checkout.

All items require a pretest standard ambient checkout to provide baseline data. Conduct the pretest checkout as follows:

- Step 1 Stabilize the test item temperature at standard ambient conditions.
- Step 2 Conduct a complete visual examination of the test item with special attention to sealed areas, gaskets/seals, and structural integrity, and document the results. Take photographs, if appropriate. Verify that no free water is present; if so, dry.
- Step 3 Conduct an operational checkout in accordance with the test plan and record the results.
- Step 4 If the test item operates satisfactorily and seals appear to function as intended, proceed to Step 1 of the test procedure. If not, resolve the problem and restart at Step 1 of pretest checkout.

4.4.2 Procedure I - Immersion.

- Step 1 If weight gain is likely to be an acceptable method of determining leakage, weigh the test item.
- Step 2 Three times immediately before the test, open and close (or remove and replace) any doors, covers, etc., that would be opened during normal use to ensure any seals are functioning properly and are not adhering to the sealing (mating) surfaces.
- Step 3 Measure and record the immersion water temperature.
- Step 4 Condition the test item as in paragraph 2.3.2.2 and record the conditioning temperature and duration. Leave the test item's sealed areas (where appropriate) open throughout the conditioning cycle. Also, materiel occasionally incorporates valves or venting devices that may or may not be opened in normal service use. If the test item incorporates such devices, open them throughout the conditioning portion of the test.

MIL-STD-810H
METHOD 512.6

- Step 5 Close all sealed areas and valves; assemble the test item in its test configuration and, as quickly as possible, immerse the test item in water so that the uppermost point of the test item is 1 ± 0.1 m below the surface of the water, or as otherwise required by the test plan. The orientation of the test item should represent that of its expected in-service orientation. If several orientations are possible, select that which is most severe.
- Step 6 Following a 30-minute immersion period (or as otherwise specified in the test plan), remove the test item from the water, wipe the exterior surfaces dry (giving special attention to areas around seals and relief valves) and, if applicable, equalize the air pressure inside by activating any manual valves. Be careful to not allow water to enter the test item while activating the manual valves.
- Step 7 If appropriate, re-weigh the test item.
- Step 8 Open the test item and examine the interior and contents for evidence of, and quantity of any leakage and, if leakage occurred, for probable areas of entry. If using fluorescein use a blacklight to determine if any of the fluorescein dye has penetrated the test item.
- Step 9 If appropriate; conduct an operational check of the test item and record results. See paragraph 5 for analysis of results.

4.4.3 Procedure II - Fording.

Conduct the fording test in one of two ways: by towing or driving the test item through water at the appropriate depth, or by securing the test item in a tank and flooding the tank to the required depth. Unless otherwise justified, condition the test item as in paragraph 2.3.2.2.

- Step 1 If weight gain is likely to be an acceptable method of determining leakage, weigh the test item prior to the test.
- Step 2 With the test item in its fording configuration, **ensure that any drain plugs or apparatus are closed**, and either:
- Tow or drive the test item into the water at the required depth.
 - Secure the test item in a watertight tank.
- Step 3 If using the tank method; flood the tank to the required height above the bottom of the test item.
- Step 4 Maintain the test item in the water for a duration as determined in paragraph 2.3.2.6.
- Step 5 Either remove the test item from the water, or drain the water from the facility, and inspect the interior of the test item for evidence of free water.
- Step 6 Measure and record the amount of any free water, and the probable point(s) of entry. If appropriate, re-weigh the test item.

5. ANALYSIS OF RESULTS.

In addition to that specified in Part One, paragraphs 5.14 and 5.17, any evidence of water penetration into the test item following this test must be assessed for its short and long term effects, as well as the requirements of the test item specification. To assist in the evaluation of test results, consider the effects of free water as well as the increase of relative humidity in closed containers following the evaporation of any free water.

6. REFERENCE/RELATED DOCUMENTS.**6.1 Referenced Documents.**

NATO STANAG 2805, Fording and Floatation Requirements for Combat and Support Ground Vehicles.

6.2 Related Documents.

- NATO STANAG 4370, Environmental Testing.
- NATO Allied Environmental Conditions and Test Publication (AECTP) 300, Climatic Environmental Testing (under STANAG 4370), Method 307.

MIL-STD-810H
METHOD 512.6

- c. Egbert, Herbert W. "The History and Rationale of MIL-STD-810 (Edition 2)", January 2010; Institute of Environmental Sciences and Technology, Arlington Place One, 2340 S. Arlington Heights Road, Suite 100, Arlington Heights, IL 60005-4516.

(Copies of Department of Defense Specifications, Standards, and Handbooks, and International Standardization Agreements are available online at <https://assist.dla.mil>.)

Requests for other defense-related technical publications may be directed to the Defense Technical Information Center (DTIC), ATTN: DTIC-BR, Suite 0944, 8725 John J. Kingman Road, Fort Belvoir VA 22060-6218, 1-800-225-3842 (Assistance--selection 3, option 2), <http://www.dtic.mil/dtic/>; and the National Technical Information Service (NTIS), Springfield VA 22161, 1-800-553-NTIS (6847), <http://www.ntis.gov/>.

MIL-STD-810H
METHOD 513.8**METHOD 513.8**
ACCELERATION**CONTENTS**

<u>Paragraph</u>	<u>Page</u>
1. SCOPE	1
1.1 PURPOSE	1
1.2 APPLICATION	1
1.3 LIMITATIONS.....	1
1.3.1 ACCELERATION.....	1
1.3.2 AERODYNAMIC LOADS	1
1.3.3 ACCELERATION VERSUS SHOCK.....	1
1.3.4 CLIMATIC CONDITIONING	1
2. TAILORING GUIDANCE.....	1
2.1 SELECTING THE ACCELERATION METHOD	1
2.1.1 EFFECTS OF ACCELERATION	2
2.1.2 SEQUENCE AMONG OTHER METHODS.....	2
2.2 SELECTING A PROCEDURE.....	2
2.2.1 PROCEDURE SELECTION CONSIDERATIONS	2
2.2.2 DIFFERENCE AMONG PROCEDURES.....	2
2.2.2.1 PROCEDURE I - STRUCTURAL TEST	2
2.2.2.2 PROCEDURE II - OPERATIONAL TEST	2
2.2.2.3 PROCEDURE III - CRASH HAZARD ACCELERATION TEST	3
2.2.2.4 PROCEDURE IV – STRENGTH TEST.....	3
2.3 DETERMINE TEST LEVELS AND CONDITIONS	3
2.3.1 TEST AXES.....	3
2.3.2 TEST LEVELS AND CONDITIONS - GENERAL.....	3
2.3.3 TEST LEVELS AND CONDITIONS - FIGHTER AND ATTACK AIRCRAFT	8
2.4 SPECIAL CONSIDERATIONS.....	9
3. INFORMATION REQUIRED.....	10
3.1 PRETEST.....	10
3.2 DURING TEST.....	11
3.3 POST-TEST	11
4. TEST PROCESS	11
4.1 TEST FACILITY	11
4.2 CONTROLS	11
4.2.1 CALIBRATIONS.....	11
4.2.2 TOLERANCES.....	11
4.3 TEST INTERRUPTION	12
4.3.1 INTERRUPTION DUE TO LABORATORY EQUIPMENT MALFUNCTION.....	12
4.3.2 INTERRUPTION DUE TO TEST ITEM OPERATION FAILURE	12
4.4 TEST SETUP.....	12
4.5 TEST EXECUTION	12
4.5.1 PREPARATION FOR TEST.....	12
4.5.1.1 PRETEST STANDARD AMBIENT CHECKOUT.....	12
4.5.1.2 MOUNTING OF THE TEST ITEM	13
4.5.2 PROCEDURE I - STRUCTURAL TEST	14
4.5.3 PROCEDURE II - OPERATIONAL TEST	14

MIL-STD-810H
METHOD 513.8

CONTENTS - Continued

<u>Paragraph</u>	<u>Page</u>
4.5.3.1 CENTRIFUGE	14
4.5.3.2 TRACK/ROCKET POWERED SLED	14
4.5.4 PROCEDURE III - CRASH HAZARD ACCELERATION TEST	15
4.5.5 PROCEDURE IV - STRENGTH TEST.....	15
5. ANALYSIS OF RESULTS	15
5.1 GENERAL	15
5.2 SPECIFIC TO THIS METHOD.....	15
5.2.1 STRUCTURAL TEST.....	15
5.2.2 OPERATIONAL TEST	16
5.2.3 CRASH HAZARD ACCELERATION TEST	16
5.2.4 STRENGTH TEST	16
6. REFERENCE/RELATED DOCUMENTS	16
6.1 REFERENCED DOCUMENTS.....	16
6.2 RELATED DOCUMENTS.....	16

TABLES

TABLE 513.8-I. SUGGESTED G LEVELS FOR PROCEDURE I - STRUCTURAL TEST	4
TABLE 513.8-II. SUGGESTED G LEVELS FOR PROCEDURE II - OPERATIONAL TEST	5
TABLE 513.8-III. SUGGESTED G LEVELS FOR PROCEDURE III - CRASH HAZARD ACCELERATION TEST	6
TABLE 513.8-IV. SYSTEM SPECIFIC G LEVELS FOR PROCEDURE III- CRASH HAZARD ACCELERATION TEST	7

FIGURES

FIGURE 513.8-1. EXAMPLE SINE BURST TEST SPECIFICATION FOR STRENGTH TESTING	8
FIGURE 513.8-2. TYPICAL DIRECTIONS OF VEHICLE ACCELERATION (RIGHT HAND RULE).....	8

**METHOD 513.8 ANNEX A
TEST CONSIDERATIONS**

1. TEST ITEM MOUNTING FIXTURE	A-1
1.1 FIXTURE DESIGN CONSIDERATIONS	A-1
1.2 FIXTURE MATERIALS AND CONSTRUCTION.....	A-5
1.3 GENERAL CONSIDERATIONS IN CENTRIFUGE TESTING.....	A-5
2. FAILURE DETECTION PROBLEMS.....	A-6
3. ACCELERATION AND FORCE CALCULATION	A-6

FIGURES

FIGURE 513.8A-1. BASIC CENTRIFUGE TEST INSTALLATION RESULTING COMPRESSIVE LOAD CONDITIONS	A-2
FIGURE 513.8A-2. A TYPICAL CENTRIFUGE TEST INSTALLATION REQUIRING CONSIDERATION OF MOMENT EFFECTS IN INSTALLATION DESIGN	A-3
FIGURE 513.8A-3. BASIC CENTRIFUGE TEST INSTALLATION RESULTING IN TENSILE LOAD CONDITIONS	A-4
FIGURE 513.8A-4. BASIC FORCES IMPOSED ON TEST ITEM DUE TO ACCELERATIONS PRODUCED BY CENTRIFUGE	A-7

MIL-STD-810H
METHOD 513.8**METHOD 513.8**
ACCELERATION

NOTE: Tailoring is essential. Select methods, procedures and parameter levels based on the tailoring process described in Part One, paragraph 4.2.2, and Annex C. Apply the general guidelines for laboratory test methods described in Part One, paragraph 5 of this Standard.

1. SCOPE.**1.1 Purpose.**

The acceleration test is performed to assure that materiel can structurally withstand the steady state inertia loads that are induced by platform acceleration, deceleration, and maneuver in the service environment, and function without degradation during and following exposure to these forces. Acceleration tests are also used to assure that materiel does not become hazardous after exposure to crash inertia loads.

1.2 Application.

This test Method is applicable to materiel that is installed in aircraft, helicopters, manned aerospace vehicles, air-carried stores, and ground/sea-launched missiles.

1.3 Limitations.**1.3.1 Acceleration.**

As addressed in this Method, acceleration is a load factor (inertia load, "g" load) applied slowly enough and held steady for a period of time long enough such that the materiel has sufficient time to fully distribute the resulting internal loads, and such that dynamic (resonant) response of the materiel is not excited. Where loads do not meet this definition, more sophisticated analysis, design, and test methods are required.

1.3.2 Aerodynamic Loads.

Materiel mounted such that any or all surfaces are exposed to aerodynamic flow during platform operations are subject to aerodynamic loads in addition to inertia loads. This method is not generally applicable to these cases. Materiel subject to aerodynamic loads must be designed and tested to the worst case combinations of these loads. This often requires more sophisticated test methods usually associated with airframe structural (static and fatigue) tests.

1.3.3 Acceleration versus Shock.

Acceleration loads are expressed in terms of load factors that, although dimensionless, are usually labeled as "g" loads. Shock environments (Methods 516.8 and 517.3) are also expressed in "g" terms. This sometimes leads to the mistaken assumption that acceleration requirements can be satisfied by shock tests or vice versa. Shock is a rapid motion that excites dynamic (resonant) response of the materiel, but with very little overall deflection (stress). Shock test criteria and test methods cannot be substituted for acceleration criteria and test methods or vice versa.

1.3.4 Climatic Conditioning.

Special provisions for performing combined acceleration/climatic environment tests (e.g., acceleration tests at high or low temperatures) may be required for certain operational tests. Guidelines found in the climatic test methods may be helpful in setting up and performing combined environment tests.

2. TAILORING GUIDANCE.**2.1 Selecting the Acceleration Method.**

After examining requirements documents and applying the tailoring process in Part One of this Standard to determine where acceleration effects are foreseen in the life cycle of the materiel, use the following to confirm the need for this Method and to place it in sequence with other methods.

MIL-STD-810H
METHOD 513.8**2.1.1 Effects of Acceleration.**

Acceleration results in loads on mounting hardware and internal loads within materiel. Note that all elements of the materiel are loaded, including fluids. The following is a partial list of detrimental effects from high levels of acceleration. If there is expectation that any of these may occur, it confirms the need to test for this effect.

- a. Structural deflections that interfere with materiel operation.
- b. Permanent deformation, structural cracks, and fractures that disable or destroy materiel.
- c. Broken fasteners and supports that result in loose parts within materiel.
- d. Broken mounting hardware that results in loose materiel within a platform.
- e. Electronic circuit boards that short out and circuits that open up.
- f. Inductances and capacitances that change value.
- g. Relays that open or close.
- h. Actuators and other mechanisms that bind.
- i. Seals that leak.
- j. Pressure and flow regulators that change value.
- k. Pumps that cavitate.
- l. Spools in servo valves that are displaced causing erratic and dangerous control system response.

2.1.2 Sequence Among Other Methods.

- a. General. See Part One, paragraph 5.5.
- b. Unique to this Method. Examine the life cycle environmental profile to determine the test sequence.

Normally, acceleration is experienced after logistic storage and transportation environments and often near the end of the life cycle. Shock, vibration, and thermal stressing prior to acceleration testing is recommended as this will uncover failures that would not occur with unstressed items.

2.2 Selecting a Procedure.

This Method includes three test procedures.

- a. Procedure I - Structural Test.
- b. Procedure II - Operational Test.
- c. Procedure III - Crash Hazard Acceleration Test.
- d. Procedure IV - Strength Test.

2.2.1 Procedure Selection Considerations.

Subject materiel to be tested to both Procedures I and II tests unless otherwise specified. Subject manned aircraft materiel that is located in occupied areas or in egress and ingress routes to Procedure III. Procedure IV is special case for strength testing materiel that cannot be assessed by Procedures I and II.

2.2.2 Difference Among Procedures.**2.2.2.1 Procedure I - Structural Test.**

Procedure I is used to demonstrate that materiel will structurally withstand the loads induced by in-service accelerations.

2.2.2.2 Procedure II - Operational Test.

Procedure II is used to demonstrate that materiel will operate without degradation during and after being subjected to loads induced by in-service acceleration. Rationale for operational test levels can be found in paragraph 6.1, reference k.

MIL-STD-810H
METHOD 513.8**2.2.2.3 Procedure III - Crash Hazard Acceleration Test.**

Procedure III is used to disclose structural failures of materiel that may present a hazard to personnel during or after a crash. This test is intended to verify that materiel mounting and/or restraining devices will not fail and that sub-elements are not ejected during a crash. Use for materiel mounted in flight occupied areas and/or that could block aircrew/passenger egress or rescue personnel ingress after a crash. The crash hazard can be evaluated by a static acceleration test (Method 513.8, Procedure III) and/or transient shock (Method 516.8, Procedure V). The requirement for one or both procedures must be evaluated based on the test item.

Only when the system and/or attachment method has a natural frequency below the knee frequency of the shock SRS, might this test be required to supplement the Crash Hazard Shock Test (see Method 516.8, Figure 516.8-9). For planning purposes, Procedure III should be included for budgeting and scheduling consideration until it is shown by analysis or a laboratory test that this procedure isn't required.

2.2.2.4 Procedure IV – Strength Test.

Procedure IV is a strength test primarily intended to generate specific loads in primary structures using sine burst testing. This method may be used as an alternative to static pull or centrifuge testing and is suitable for testing relatively stiff components, electronics boxes, instruments, or space vehicles. The sine burst test is a base-driven test in which the test article is subjected to a few cycles (typically 2 to 10 at peak amplitude) of sinusoidal input. This is usually done below the first resonant frequency of the test article to expose the hardware to a quasi-static loading. An example test profile is shown in Figure 513.8-1.

2.3 Determine Test Levels and Conditions.

The tests vary in acceleration level, axis of acceleration, duration, test apparatus, and on/off state of test item. Obtain acceleration values for individual materiel items from the platform structural loads analyses. When the applicable platform is unknown, the values of Tables 513.8-I, 513.8-II, 513.8-III and 513.8-IV and the following paragraphs may be used as preliminary test criteria pending definition of actual installation criteria.

2.3.1 Test Axes.

For the purpose of these tests, the axes should be consistent with the sign convention and axes used in the structural analysis of the platform with the direction of forward acceleration of the platform. The test item is tested in each direction along three mutually perpendicular axes for each test procedure. One axis is aligned with the forward acceleration of the platform (fore and aft, X), one axis is aligned with the span-wise direction of the platform (lateral, Y), and the third axis is perpendicular to the plane of the other two axes (up and down, Z). Positive rotational axes and accelerations vary between platforms as they are typically determined by various means such as use of the “left hand” or “right hand rule.” Figure 513.8-2 shows a typical vehicle acceleration axes system with sign convention defined by the “right hand rule”.

2.3.2 Test Levels and Conditions - General.

Tables 513.8-I, 513.8-II, and 513.8-III & IV list test levels for Procedure I (Structural Test), Procedure II (Operational Test), and Procedure III (Crash Hazard Acceleration Test), respectively. When the orientation of the materiel item relative to the operational platform is unknown, the highest pertinent level applies to all test axes.

MIL-STD-810H
METHOD 513.8

Table 513.8-I. Suggested g levels for Procedure I - Structural Test.

Vehicle Category ^{1/}	Forward Acceleration A (g's) ^{2/}	Test Level						
		Direction of Vehicle Acceleration (See Figure 513.8-2)						
		Fore	Aft	Up	Down	Lateral		
						Left	Right	
Aircraft ^{3/, 4/}	2.0	1.5A	4.5A	6.75A	2.25A	3.0A	3.0A	
Helicopters	^{2/}	4.0	4.0	10.5	4.5	6.0	6.0	
Manned Aerospace Vehicles ^{6/}	6.0 to 12.0 ^{7/}	1.5A	0.5A	2.25A	0.75A	1.0A	1.0A	
Aircraft Stores Carried on:	Wing/Sponson	2.0	7.5A	7.5A	9.0A	4.9A	5.6A	5.6A
	Wing Tip	2.0	7.5A	7.5A	11.6A	6.75A	6.75A	6.75A
	Fuselage	2.0	5.25A	6.0A	6.75A	4.1A	2.25A	2.25A
Ground-Launched Missiles	^{8/, 9/}	1.2A	0.5A	1.2A' ^{10/}	1.2A' ^{10/}	1.2A' ^{10/}	1.2A' ^{10/}	

^{1/} Use levels specified for individual platforms and locations on/in the platforms. Use the values of this table only if platform criteria are unavailable.

^{2/} Use levels in this column when forward acceleration is unknown. When the forward acceleration of the vehicle is known, use that value for A.

^{3/} For carrier-based aircraft, use 4 as a minimum value for A, representing a basic condition associated with catapult launches.

^{4/} For attack and fighter aircraft, add pitch, yaw and roll accelerations as applicable (see paragraph 2.3.3).

^{5/} For helicopters, forward acceleration is unrelated to acceleration in other directions. Test levels are based on current and near future helicopter design requirements.

^{6/} Manned vehicles capable of flight in the Earth's atmosphere and surrounding space environment.

^{7/} When forward acceleration is not known, use the high value of the acceleration range.

^{8/} A is derived from the propulsion thrust curve data for maximum firing temperature.

^{9/} In some cases, the maximum maneuver acceleration and the maximum longitudinal acceleration will occur at the same time. When this occurs, test the materiel with the appropriate factors using the orientation and levels for the maximum (vertical) acceleration.

^{10/} Where A' is the maximum maneuver acceleration.

MIL-STD-810H
METHOD 513.8**Table 513.8-II. Suggested g levels for Procedure II - Operational Test.**

Vehicle Category ^{1/}	Forward Acceleration A (g's) ^{2/}	Test Level					
		Direction of Vehicle Acceleration (See Figure 513.8-2)					
		Fore	Aft	Up	Down	Lateral	
Left	Right						
Aircraft ^{3/,4/}	2.0	1.0A	3.0A	4.5A	1.5A	2.0A	2.0A
Helicopters	^{5/}	2.0	2.0	7.0	3.0	4.0	4.0
Manned Aerospace Vehicles ^{6/}	6.0 to 12.0 ^{7/}	1.0A	0.33A	1.5A	0.5A	0.66A	0.66A
Aircraft Stores Carried on:	Wing/Sponson	2.0	5.0A	5.0A	6.0A	3.25A	3.75A
	Wing Tip	2.0	5.0A	5.0A	7.75A	4.5A	4.5A
	Fuselage	2.0	3.5A	4.0A	4.5A	2.7A	1.5A
Ground-Launched Missiles	^{8/,9/}	1.1A	0.33A	1.1A' ^{10/}	1.1A' ^{10/}	1.1A' ^{10/}	1.1A' ^{10/}

^{1/} Use levels specified for individual platforms and locations on/in the platforms. Use the values of this table only if platform criteria are unavailable.

^{2/} Use levels in this column when forward acceleration is unknown. When the forward acceleration of the vehicle is known, use that value for A.

^{3/} For carrier-based aircraft, use 4 as a minimum value for A, representing a basic condition associated with catapult launches.

^{4/} For attack and fighter aircraft, add pitch, yaw and roll accelerations as applicable (see paragraph 2.3.3).

^{5/} For helicopters, forward acceleration is unrelated to acceleration in other directions. Test levels are based on current and near future helicopter design requirements.

^{6/} Manned vehicles capable of flight in the Earth's atmosphere and surrounding space environment.

^{7/} When forward acceleration is not known, use the high value of the acceleration range.

^{8/} A is derived from the propulsion thrust curve data for maximum firing temperature.

^{9/} In some cases, the maximum maneuver acceleration and the maximum longitudinal acceleration will occur at the same time. When this occurs, test the materiel with the appropriate factors using the orientation and levels for the maximum (vertical) acceleration.

^{10/} Where A' is the maximum maneuver acceleration.

MIL-STD-810H
METHOD 513.8**Table 513.8-III. Suggested g levels for Procedure III - Crash Hazard Acceleration Test.^{3/}**

Vehicle/Category	Test Level (g's) ^{1/}					
	Direction of Vehicle Acceleration (See Figure 513.8-2)					
	Fore	Aft	Up	Down	Left	Right
All manned air vehicles except cargo/transport						
Personnel capsule	40	12	10	25	14	14
Ejection seat	40	7	10	25	14	14
All other items ^{2/}	40	20	10	20	14	14
Helicopters ^{4/}	20	20	10	20	18	18
Cargo/transport						
Pilot and aircrew seats	16	6	7.5	16	5.5	5.5
Passenger seats	16	3	4	16	5.5	5.5
Side facing troop seats	3	3	5	16	3	3
Personnel restraint	10	5	5	10	3	3
Stowable troop seats	10	5	5	10	10	10
All other items ^{2/}	20	10	10	20	10	10
Helicopters ^{4/}	20	20	10	20	18	18

^{1/} Use levels specified for individual platforms and locations on/in the platforms. Use the values of this table only if platform criteria are unavailable.

^{2/} The intent of this test is to disclose structural failures of materiel that may present a hazard to personnel during or after a crash. This test is intended to verify that materiel mounting and/or restraining devices will not fail and that sub-elements are not ejected during a crash. Use for materiel mounted in flight occupied areas and/or that could block aircrew/passenger egress or rescue personnel ingress after a crash.

^{3/} Test item function is not required following this test. Thus test items that are not suitable for other tests or field use may be used for this test. Ensure test items are structurally representative (strength, stiffness, mass, and inertia) of the production design, but need not be functional. All contents (including fluids) designed to be carried in/on the materiel should be included. Tactical restraint systems should be loaded with the maximum expected weight.

^{4/} See paragraph 6.1, reference a. Some system specific crash hazard acceleration levels are provided in Table 513.8-IV.

MIL-STD-810H
METHOD 513.8**Table 513.8-IV. System specific g levels for Procedure III - Crash Hazard Acceleration Test.**

AH-64 A & D Aircraft Crash Test Levels (g's) ^{1/}					
Direction of Vehicle Acceleration	Applied Separately	Applied Simultaneously ^{6/}			Transport Acceleration Applied Separately (items not able to reach cockpit)
Up	20	10	20	10	4.5
Down	10	5	10	5	2
Lateral	±20	±10	±10	±20	1.5
Forward	20	20	10	10	1.5
Aft	20	20	10	10	3
OH-58D Kiowa Warrior Aircraft Crash Test Levels (g's) (Applied Separately) ^{2/}					
Direction of Vehicle Acceleration	Seat (200 lb per)	Cargo Equipment (items that can get into cockpit) ^{6/}			Equipment Mounted in Aft Equipment Compartment
Up	20		16		8
Down	10		8		4
Lateral	20		16		8
Forward	10		8		4
Aft	10		16		8
CH-47D/F Aircraft Crash Test Levels (g's) ^{3/}					
Direction of Vehicle Acceleration	Applied Separately				
Up	-				
Down	8				
Lateral	8				
Forward	8				
Aft	-				
UH-1H Aircraft Crash Test Levels (g's) ^{4/}					
Direction of Vehicle Acceleration	Applied Separately				
Up	8				
Down	4				
Lateral	±8				
Forward	8				
Aft	-				
UH/HH/MH-60A/L/M Aircraft Crash Test Levels (g's) ^{5/}					
Direction of Vehicle Acceleration	Applied Separately	Applied Simultaneously ^{6/}			External ^{6/} (in any combination)
Up	20	10	20	10	6
Down	10	5	10	5	3
Lateral	±18	±9	±9	±18	3 (in) / 6 (out)
Forward	20	20	10	10	6
Aft	20	20	10	10	-
^{1/} See Design Criteria Report, Report No. 77-Y-8001-3 paragraph 6.1, reference b. ^{2/} See System Specification, Specification No. 406-947-500B paragraph 6.1, reference c. ^{3/} See reference Structural Design Criteria, Document No. 145-SS-603 paragraph 6.1, reference d. ^{4/} See reference System Specification, Contract DAAJ01-74-C-0175 paragraph 6.1, reference e. ^{5/} See reference Aircraft Specification, Document No. SES-700700 paragraph 6.1, reference f. ^{6/} Apply the worst case combination of test levels simultaneously. The requirement to test in different directions simultaneously can be accomplished through angled fixtures.					

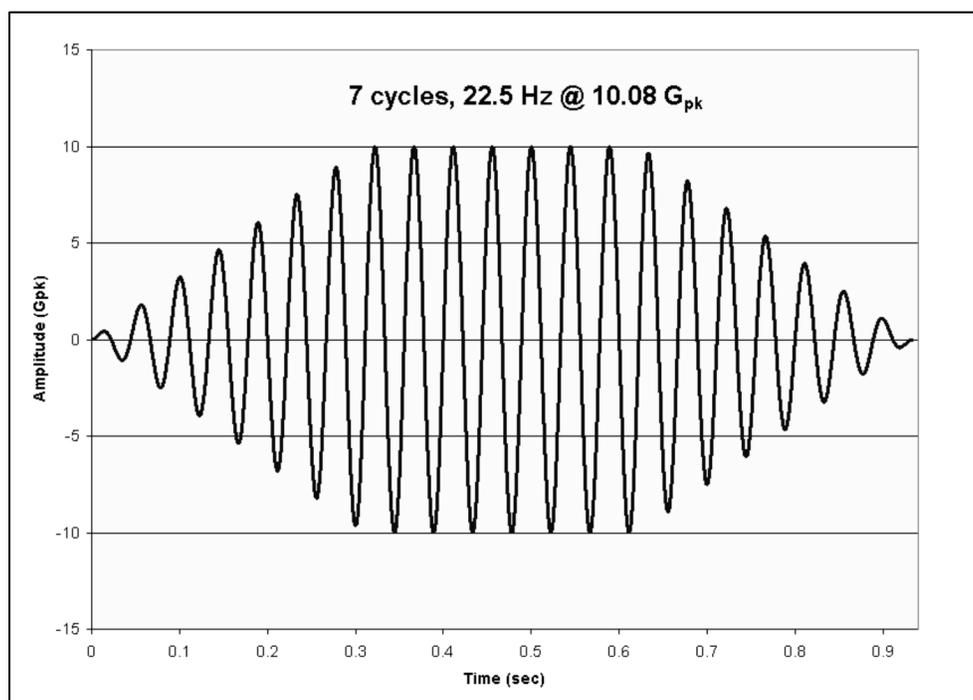
MIL-STD-810H
METHOD 513.8

Figure 513.8-1. Example sine burst test specification for strength testing (from NASA-HDBK-7008).

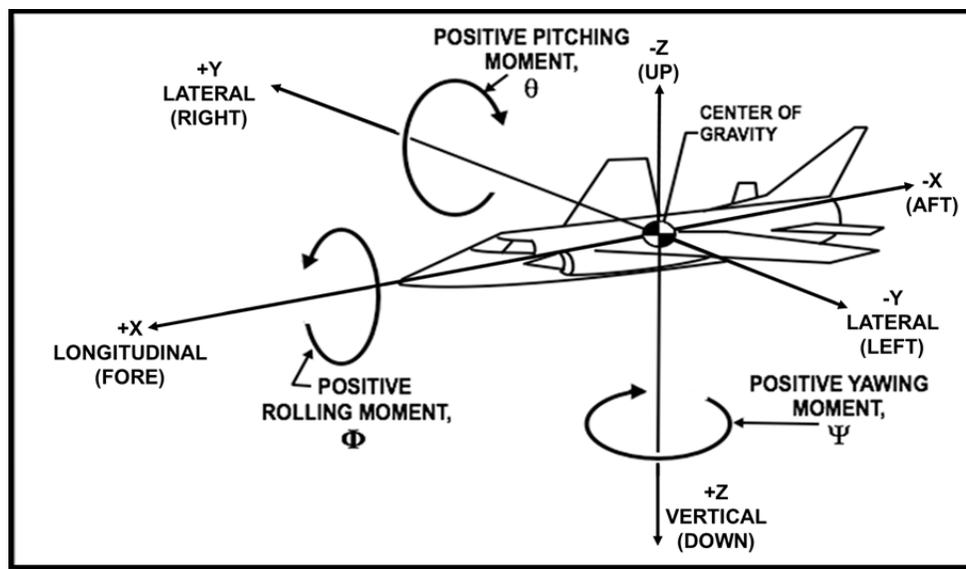


Figure 513.8-2. Typical directions of vehicle acceleration (right hand rule).

2.3.3 Test Levels and Conditions - Fighter and Attack Aircraft.

The test levels as determined from Tables 513.8-I and 513.8-II are based on accelerations at the center of gravity (CG) of the platform. For fighter and attack aircraft, the test levels, must be increased for materiel that is located away from the vehicle CG to account for loads induced by roll, pitch, and yaw during maneuvers. When criteria are developed for specific aircraft, maneuver cases are considered and the resulting additional angular accelerations may add or subtract effects from the linear acceleration effects. When the following relationships (a-f) are used, it must be

MIL-STD-810H
METHOD 513.8

assumed that the load factors always add. Thus absolute values are used in the equations. Add the load factors derived below to the Operational Test (Procedure II) levels of Table 513.8-II. Multiply the load factors derived below by 1.5 and add to the Structural Test (Procedure I) levels of Table 513.8-I. Do not add these values to the Crash Hazard Acceleration Test (Procedure III) levels of Tables 513.8-III and 513.8-IV.

- a. Roll maneuver, up and down test direction. The additional load factor (ΔN_z) induced by roll, is computed as follows:

$$\Delta N_z = (z/g) (d\phi/dt)^2 + (y/g) d^2\phi/dt^2$$

- b. Roll maneuver, lateral left and lateral right directions. The additional load factor (ΔN_y) induced by roll, is computed as follows:

$$\Delta N_y = (y/g) (d\phi/dt)^2 + (z/g) d^2\phi/dt^2$$

- c. Pitch maneuver, up and down test directions. The additional load factor (ΔN_z) induced by pitch change, is computed as follows:

$$\Delta N_z = (z/g) (d\theta/dt)^2 + (x/g) d^2\theta/dt^2$$

- d. Pitch maneuver, fore and aft test directions. The additional load factor (ΔN_x) induced by pitch change, is computed as follows:

$$\Delta N_x = (x/g) (d\theta/dt)^2 + (z/g) d^2\theta/dt^2$$

- e. Yaw maneuver, lateral left and right test directions. The additional load factor (ΔN_y) induced by yaw, is computed as follows:

$$\Delta N_y = (y/g) (d\psi/dt)^2 + (x/g) d^2\psi/dt^2$$

- f. Yaw maneuver, fore and aft test directions. The additional load factor (ΔN_x) induced by yaw change, is computed as follows:

$$\Delta N_x = (x/g) (d\psi/dt)^2 + (y/g) d^2\psi/dt^2$$

Where:

x = fore and aft distance of materiel from the aircraft CG, m (in.)

y = lateral distance of materiel from the aircraft CG, m (in.)

z = vertical distance of materiel from the aircraft CG, m (in.)

g = acceleration of gravity, 9.81 m/sec² (386 in/sec²)

ϕ = angle of rotation about the X axis (roll), rad

$d\phi/dt$ = maximum roll velocity in rad/sec (if unknown use 5 rad/sec)

$d^2\phi/dt^2$ = maximum roll acceleration in rad/sec² (if unknown use 20 rad/sec²)

θ = angle of rotation about the Y axis (pitch), rad

$d\theta/dt$ = maximum pitch velocity in rad/sec (if unknown use 2.5 rad/sec)

$d^2\theta/dt^2$ = maximum pitch acceleration in rad/sec² (if unknown use 5 rad/sec²)

ψ = angle of rotation about the Z axis (yaw), rad

$d\psi/dt$ = maximum yaw velocity in rad/sec (if unknown use 4 rad/sec)

$d^2\psi/dt^2$ = maximum yaw acceleration in rad/sec² (if unknown use 3 rad/sec²)

2.4 Special Considerations.

- a. Sway space measurements. If a piece of materiel is mounted on vibration isolators or shock mounts, perform the tests with the materiel mounted on the isolators/mounts. Measure the deflections of the isolators/mounts while the test item is exposed to the test accelerations. These data are needed to indicate potential interference with adjacent materiel, (i.e., define sway space requirements).

MIL-STD-810H
METHOD 513.8

- b. Acceleration simulation. Careful assessment of the function and characteristics of the test item has to be made in selecting the apparatus on which the acceleration tests are to be performed due to the differences in the manner in which acceleration loads are produced. There are two types of apparatus that are commonly used: the centrifuge and a track/rocket-powered sled combination.
- c. Centrifuge. The centrifuge generates acceleration loads by rotation about a fixed axis. The direction of acceleration is always radially toward the center of rotation of the centrifuge, whereas the direction of the load induced by acceleration is always radially away from the axis of rotation. When mounted directly on the test arm, the test item experiences both rotational and translational motion. Ensure the centrifuge or turn table is properly balanced. The direction of the acceleration and the load induced is constant with respect to the test item for a given rotational speed, but the test item rotates 360 degrees for each revolution of the arm. Certain centrifuges have counter-rotating fixtures mounted on the test arm to correct for rotation of the test item. With this arrangement, the test item maintains a fixed direction with respect to space, but the direction of the acceleration and the induced load rotates 360 degrees around the test item for each revolution of the arm. Another characteristic is that the acceleration and induced load are in direct proportion to the distance from the center of rotation. This necessitates the selection of a centrifuge of adequate size so that the portions of the test item nearest to and furthest from the center of rotation are subjected to not less than 90 percent or more than 110 percent, respectively, of the specified test level. Further information regarding centrifuge testing may be found in paragraph 6.1, reference g.
- d. Track/rocket-powered sled. The track/rocket-powered sled test arrangement generates linear acceleration in the direction of the sled acceleration. The test item mounted on the sled is uniformly subjected to the same acceleration level that the sled experiences. The acceleration test level and the time duration at the test level is dependent upon the length of the track, the power of the rocket, and the rocket charge. The sled track generally will produce a significant vibration environment due to track roughness. Typically this vibration is significantly more severe than the normal in-service use environment. Careful attention to the attachment design may be needed to isolate the test item from this vibration environment. In performing Procedure II tests, the support equipment necessary to operate the test item is mounted on the sled and traverses the track with the test item. This requires the use of self-contained power units and a remote control system to operate the test item while traversing the track. Telemetry or ruggedized instrumentation is required to measure the performance of the test item while it is exposed to the test load. Further information regarding rocket sled testing may be found in paragraph 6.1, reference h.
- e. Sine burst testing. This method allows strength testing to be conveniently performed as part of a planned dynamic test sequence. Test schedule efficiency is improved because the test item can remain installed on the shaker table after a vibration test eliminating tear down, transport, and setup times at another facility. Note, it is important that all parties involved fully understand the risks and limitations of this approach. Possible test item damage may be caused by: shaker displacement limitations; open loop shaker control; and depending upon the level of test item assembly there may be unexpected amplification of component resonances in the hardware. Further information regarding this method may found in paragraph 6.1, reference i.

3. INFORMATION REQUIRED.

3.1 Pretest.

The following information is required to conduct acceleration tests adequately.

- a. General. Information listed in Part One, paragraphs 5.7 and 5.9; and Part One, Annex A, Task 405 of this Standard.
- b. Specific to this test Method.
 - (1) Vector orientation of test item with respect to the fixture.
 - (2) Vector orientation of fixture with respect to direction of acceleration.
 - (3) Photos of the test item and test setup before the tests.
 - (4) Center of gravity of the test item.

MIL-STD-810H
METHOD 513.8

- c. Tailoring. Necessary variations in the basic test procedures to accommodate LCEP requirements and facility limitations.

3.2 During Test.

Collect the following information during conduct of the test:

- a. General. Information listed in Part One, paragraph 5.10; and in Part One, Annex A, Tasks 405 and 406 of this Standard.
- b. Specific to this Method.
 - (1) Information related to failure criteria for test materiel under acceleration for the selected procedure or procedures. Pay close attention to any test item instrumentation and the manner in which the information is received from the sensors. For example, the acquisition of sensor signals from a test item on a centrifuge must consider either the way of bringing the sensor signals out through the centrifuge, a way of telemetering the sensor signals, or the effects of the acceleration on a recorder mounted on the centrifuge near the sensor for obtaining the sensor signals.
 - (2) Photos of the test item and test setup during tests.
 - (3) Record the time history of pertinent test data using a data recording device.

3.3 Post-Test.

The following post test data shall be included in the test report.

- a. General. Information listed in Part One, paragraph 5.13; and in Part One, Annex A, Task 406 of this Standard.
- b. Specific to this Method.
 - (1) Vector orientation of test item with respect to the fixture.
 - (2) Vector orientation of fixture with respect to direction of acceleration.
 - (3) Photos of the test item after the tests.
 - (4) Record of time history pertinent test data.
 - (5) Any deviations from the original test plan.

4. TEST PROCESS.**4.1 Test Facility.**

The required apparatus consists of either a centrifuge of adequate size or a track/rocket-powered sled test arrangement. Recommend a centrifuge for all Procedure I (Structural Test), Procedure III (Crash Hazard Acceleration Test), and most of Procedure II (Operational Test) evaluations. Use a track/rocket-powered sled test arrangement for Procedure II evaluations when strictly linear accelerations are required. In general, acceleration tests will not be instrumented. If there is need for test apparatus or test fixture/test item instrumentation, follow practices and procedures outlined in paragraph 6.1, reference j. Verification of the correct input acceleration to the test item will be according to procedures established at the test facility.

4.2 Controls.**4.2.1 Calibrations.**

Ensure any acceleration measurement for test verification has been made by instrumentation properly calibrated to the amplitude and frequency ranges of measurement.

4.2.2 Tolerances.

Maintain the acceleration level between 90 percent and 110 percent of the specified level over the full dimensions of the test item.

MIL-STD-810H
METHOD 513.8**4.3 Test Interruption.**

Test interruptions can result from two or more situations, one being from failure or malfunction of test chambers or associated test laboratory equipment. The second type of test interruption results from failure or malfunction of the test item itself during required or optional performance checks.

4.3.1 Interruption Due To Laboratory Equipment Malfunction.

- a. General. See Part One, paragraph 5.11, of this Standard.
- b. Specific to this Method.
 - (1) If an unscheduled interruption occurs while the test item is at a specified test level, restart and run the complete test. If interruptions result in several new starts, evaluate the test item for fatigue damage. (Each application of acceleration is a single loading cycle. Duration of a loading cycle does not influence the severity of the test.)
 - (2) If the test item is subjected to acceleration loads in excess of the level specified for the test, stop the test, inspect the test item and perform a functional test. Based on the inspection and functional test, make an engineering decision as to whether to resume testing with the same test item or with a new test item.

4.3.2 Interruption Due To Test Item Operation Failure.

Failure of the test item(s) to function as required during mandatory or optional performance checks during testing presents a situation with several possible options.

- a. The preferable option is to replace the test item with a “new” one and restart from Step 1.
- b. A second option is to replace / repair the failed or non-functioning component or assembly with one that functions as intended, and restart the entire test from Step 1.

NOTE: When evaluating failure interruptions, consider prior testing on the same test item and consequences of such.

4.4 Test Setup.

See Part One, paragraph 5.8.

4.5 Test Execution.

The following steps provide the basis for collecting necessary information concerning the test item in a constant acceleration environment.

4.5.1 Preparation for Test.**4.5.1.1 Pretest Standard Ambient Checkout.**

All items require a pretest standard ambient checkout to provide baseline data and additional inspections and performance checks during and after tests. Conduct inspections as follows:

- Step 1 Examine the test item for physical defects, etc., and record findings.
- Step 2 Prepare the test item for test, in its operating configuration if required, as specified in the test plan.
- Step 3 Obtain sufficient dimensional measurements of the test item to provide a reference guide for the evaluation of physical damage that may be induced during the tests.
- Step 4 Examine the test item/fixture/centrifuge/sled combination for compliance with the test item and test plan requirements.

MIL-STD-810H
METHOD 513.8

- Step 5 If applicable, conduct an operational checkout in accordance with the test plan, and document the results. If the test item operates satisfactorily, proceed to paragraph 4.5.2 or 4.5.3 as appropriate. If not, resolve the problems and repeat this Step.

4.5.1.2 Mounting of the Test Item.

Configure the test item for service application. Mount the test item on the test apparatus using the hardware that is normally used to mount the materiel in its service installation.

a. Centrifuge mounting.

- Step 1 Determine the mounting location for the test item by measurement from the center of rotation of the centrifuge to the location on the centrifuge arm that will provide the g level established for the test. Mount the test item so that its center of gravity is at the location on the arm determined for the test load factor (g level). Calculate test levels as follows:

$$N_T = K r n^2$$

Where:

N_T = test load factor (load factor within the centrifuge plane of rotation)

K = 1.118×10^{-3} , r in meters ($K = 2.838 \times 10^{-5}$, r in inches)

r = radial distance in meters, (inches) from the center of rotation to the mounting location on centrifuge arm

n = angular velocity of centrifuge arm in revolutions per minute (rpm)

- Step 2 Orient the test item on the centrifuge for the six test direction conventions as follows:

- (a) Fore. Front or forward end of test item facing toward center of centrifuge.
- (b) Aft. Reverse the test item 180 degrees from fore position.
- (c) Up. Top of test item facing toward center of centrifuge.
- (d) Down. Reverse item 180 degrees from up position.
- (e) Lateral left. Left side of test item facing toward center of centrifuge.
- (f) Lateral right. Right side of test item facing toward center of centrifuge.

- Step 3 After the test item is properly oriented and mounted on the centrifuge, make measurements and calculations to ensure the end of the test item nearest to the center of the centrifuge will be subjected to no less than 90 percent of the g level established for the test. If the g level is found to be less than 90 percent of the established g level, either mount the test item further out on the centrifuge arm and adjust the rotational speed accordingly, or use a larger centrifuge to ensure the end of the test item nearest to the center of the centrifuge is subjected to at least 90 percent of the established g level. However, do not subject the opposite end of the test item (the end farthest from the center of the centrifuge) to over 110 percent of the established g level. For large test items, consider exceptions for load gradients based on the existing availability of large centrifuges in commercial or government test facilities.

- b. Track/rocket-powered-sled mounting. For track/rocket-powered sled mounting, mount the test item and associated test fixture or apparatus on the sled platform in accordance with the controlled acceleration direction of the sled. (Ensure the test fixture or apparatus has been designed to isolate sled vibrations from the test item.) Since the sled and test item experience the same g levels, only the orientation of the test item on the sled is critical. Orient the test item on the sled according to the acceleration directions shown on Figure 513.8-2 and the controlled acceleration direction of the sled for the six test directions.
- c. Shaker mounting. Before starting a test, review pretest information in the test plan to determine test details (test item configuration(s), levels, durations, failure criteria, item operational requirements, instrumentation requirements, facility capability, fixture(s), etc.).

- Step 1 Select appropriate vibration exciters and fixtures.

MIL-STD-810H
METHOD 513.8

- Step 2 Select appropriate data acquisition system (e.g., instrumentation, cables, signal conditioning, recording, analysis equipment).
- Step 3 Operate vibration equipment without the test item installed to confirm proper operation.
- Step 4 Ensure the data acquisition system functions as required.

4.5.2 Procedure I - Structural Test.

- Step 1 With the test item installed as in paragraph 4.5.1.2, bring the centrifuge to the speed required to induce the specified g level in the test item as determined from paragraph 2.3 and Table 513.8-I for the particular test item orientation. Maintain this g level for at least one minute after the centrifuge rpm has stabilized.
- Step 2 Stop the centrifuge and inspect the test item as specified in paragraph 4.5.1.1.
- Step 3 Operationally test and inspect the test item as specified in paragraph 4.5.1.1. If the test item fails to operate as intended, see paragraph 5 for analysis of results, and follow the guidance in paragraph 4.3.2 for test item failure.
- Step 4 Repeat this test procedure for the remaining five test directions noted in paragraph 4.5.1.2.a, Step 2.
- Step 5 Upon completing the tests in the six test directions, remove the test item from the centrifuge and, if required, perform one final operational check and physical inspection. See paragraph 5 for analysis of results.

4.5.3 Procedure II - Operational Test.**4.5.3.1 Centrifuge.**

- Step 1 With the test item installed as in paragraph 4.5.1.2, operationally test and inspect the test item as specified in paragraph 4.5.1.1.
- Step 2 With the test item operating, bring the centrifuge to the speed required to induce specified g level in the test item as determined from paragraph 2.3 and Table 513.8-II for the particular test item orientation. Maintain this g level for at least one minute after the centrifuge rpm has stabilized. Conduct an operational check and document the results. If the test item fails to operate as intended, follow the guidance in paragraph 4.3.2 for test item failure.
- Step 3 Stop the centrifuge and operationally check and inspect the test item as specified in paragraph 4.5.1.1. If the test item fails to operate as intended, see paragraph 5 for analysis of results.
- Step 4 Repeat Steps 1-3 for the five remaining orientations noted in paragraph 4.5.1.2.a, Step 2.
- Step 5 Upon completing the tests in the six test directions, remove the test item from the centrifuge and, if required, perform one final operational check and physical inspection. See paragraph 5 for analysis of results.

4.5.3.2 Track/Rocket Powered Sled.

- Step 1 With the test item installed as in paragraph 4.5.1.2, operationally test and inspect the test item as specified in paragraph 4.5.1.1.
- Step 2 With the test item operating, accelerate the sled to the level required to induce the specified g level in the test item as determined from paragraph 2.3 and Table 513.8-II for the particular test item orientation. Conduct a performance check while the test item is subjected to the specified g level. Document the results.
- Step 3 Evaluate test run parameters and determine if the required test acceleration was achieved.
- Step 4 Repeat the test run as necessary to demonstrate acceptable performance of the test item while under required test acceleration. Document the test run parameters.
- Step 5 Repeat this test procedure for the five remaining test directions noted in paragraph 4.5.1.2a, Step 2. Upon completing the tests in the six test directions, operationally check and inspect the test item according to paragraph 4.5.1.1. See paragraph 5 for analysis of results.

MIL-STD-810H
METHOD 513.8**4.5.4 Procedure III - Crash Hazard Acceleration Test.**

- Step 1 With the test item installed as in paragraph 4.5.1.2, bring the centrifuge to the speed required to induce the specified g level in the test item as determined from paragraph 2.3 and Table 513.8-III or Table 513.8-IV for the particular test item orientation. Maintain this g level for at least one minute after the centrifuge rpm has stabilized.
- Step 2 Stop the centrifuge and inspect the test item as specified in paragraph 4.5.1.1.
- Step 3 Inspect the test item as specified in paragraph 4.5.1.1.
- Step 4 Repeat this test procedure for the remaining five test directions noted in paragraph 4.5.1.2.a, Step 2.
- Step 5 Upon completing the tests in the six test directions, inspect the test item as specified in paragraph 4.5.1.1. See paragraph 5 for analysis of results.

4.5.5 Procedure IV – Strength Test.

- Step 1 Select the test conditions which are within the shaker displacement limits and mount the test item (or dynamic simulant item) on the vibration exciter. Use of a simulant may be desired to assess system drive signal magnitudes. Install accelerometers, force gages, and other instrumentation as required.
- Step 2 If required; perform an operational check on the test item at standard ambient conditions. If the test item operates satisfactorily, proceed to Step 3. If not, resolve the problems and repeat this step.
- Step 3 Subject the test item (or dynamic simulant) to the sine burst profile. The vibration control system will be in open loop control. Examine the data and adjust the parameters to achieve the required test level. If a dynamic simulant is used, then replace the simulant with the test item.
- Step 4 Subject the test item in its operational configuration to the compensated sine burst waveform. It is often desirable to make an initial run at less than full level to ensure proper dynamic response and validate instrumentation functionality.
- Step 5 Record necessary data.
- Step 6 Examine the control acceleration time trace for conformance to the test profile. Perform a visual inspection of the test item. Conduct an operational check on the test item and record the performance data as required.
- Step 7 Repeat Steps 4, 5, and 6 for the number of replications called out in the requirements document, or a minimum of three times for statistical confidence provided the integrity of the test configuration is preserved during the test.
- Step 8 Remove the test item from the fixture/shaker and inspect the test item, mounting hardware, components, etc., for any signs of visual mechanical degradation that may have occurred during testing.
- Step 9 If required, repeat Steps 1-8 for each excitation axis.
- Step 10 Document the test series including the saving of all control and monitor digital time traces, and see paragraph 5.2.4 for analysis of results.

5. ANALYSIS OF RESULTS.**5.1 General.**

Refer to the guidance in Part One, paragraphs 5.14 and 5.17; and to Part One, Annex A, Task 406.

5.2 Specific to This Method.**5.2.1 Structural Test.**

A test is successful if the test item is undamaged and fully operational at test completion.

MIL-STD-810H
METHOD 513.8**5.2.2 Operational Test.**

A test is successful if the test item is fully operational at test accelerations, and is undamaged and fully operational at test completion.

5.2.3 Crash Hazard Acceleration Test.

A test is successful if the test item remains structurally attached to the mounts and no parts, pieces, or contents are detached from the item at test completion.

5.2.4 Strength Test.

A test is successful if the test item is undamaged and fully operational. Components shall remain structurally attached to the mounts and no parts, pieces, or contents are bent or detached from the item at test completion.

6. REFERENCE/RELATED DOCUMENTS.**6.1 Referenced Documents.**

- a. Westar Aerospace and Defense Group - To Verify or Modify the MIL-STD-810 Default Acceleration Crash Safety Test Levels As Applied to Our Army Fixed and Rotary Winged Aircraft (Tasking Number 18605), 3 Jan 2006.
- b. Design Criteria Report, Report No. 77-Y-8001-3.
- c. System Specification, Specification No. 406-947-500B.
- d. Structural Design Criteria, Document No. 145-SS-603.
- e. System Specification, Contract DAAJ01-74-C-0175.
- f. Aircraft Specification, Document No. SES-700700.
- g. International Test Operations Procedure (ITOP) 05-2-586A Sustained Acceleration (Centrifuge) Testing, 8 June 2017.
- h. ITOP 05-1-029 Rocket Sled Testing, 18 September 2015.
- i. NASA-HDBK-7008 Spacecraft Dynamic Environments Testing, Paragraph 5.4.1.3, 12 June 2014.
- j. Handbook for Dynamic Data Acquisition and Analysis, IES-RP-DTE012.2, Institute of Environmental Sciences and Technology, Arlington Place One, 2340 S. Arlington Heights Road, Suite 100, Arlington Heights, IL 60005-4516; [Institute of Environmental Sciences and Technology Website](#).
- k. Westar Aerospace and Defense Group Memo - Are the MIL-STD-810F Acceleration Operational Test Levels per Table 513.5-II Too High for Army Aircraft Qualification Requirements? (Log Number 4542), 24 July 2002

6.2 Related Documents.

- a. Junker, V.J., The Evolution of USAF Environmental Testing. October 1965; AFFDL TR 65-197; DTIC No. AD 625543.
- b. Allied Environmental Conditions and Test Publication (AECTP) 400, Mechanical Environmental Tests (under STANAG 4370), Method 404.
- c. Egbert, Herbert W. "The History and Rationale of MIL-STD-810 (Edition 2)", January 2010, Institute of Environmental Sciences and Technology, Arlington Place One, 2340 S. Arlington Heights Road, Suite 100, Arlington Heights, IL 60005-4516.
- d. Rogers J.D. et.al., VIBRAFUGE - Combined Vibration and Centrifuge Testing, 60th Shock and Vibration Symposium Proceedings, SAVIAC, 1989, volume III, page 63. Shock & Vibration Information Analysis Center (SAVIAC), PO Box 165, 1104 Arvon Road, Arvon, VA 23004.

MIL-STD-810H
METHOD 513.8

(Copies of Department of Defense Specifications, Standards, and Handbooks, and International Standardization Agreements are available online at <https://assist.dla.mil>.

Requests for other defense-related technical publications may be directed to the Defense Technical Information Center (DTIC), ATTN: DTIC-BR, Suite 0944, 8725 John J. Kingman Road, Fort Belvoir VA 22060-6218, 1-800-225-3842 (Assistance--selection 3, option 2), <http://www.dtic.mil/dtic/>; and the National Technical Information Service (NTIS), Springfield VA 22161, 1-800-553-NTIS (6847), <http://www.ntis.gov/>.

MIL-STD-810H
METHOD 513.8

(This page is intentionally blank.)

MIL-STD-810H
METHOD 513.8 ANNEX A**METHOD 513.8, ANNEX A**
TEST CONSIDERATIONS**1. TEST ITEM MOUNTING FIXTURE.****1.1 Fixture Design Considerations.**

An installation design in which centrifugal force tends to hold the test item against the machine or fixture as shown in Figures 513.8A-1 and 513.8A-2 is generally preferred for unusually severe acceleration conditions, since this type of installation tends to minimize the possibility of accidental loss of the test item during a test. In this case, a compressive stress at the test item attachment location results from the normal or centripetal acceleration. A centrifuge equipped with an adjustable mounting table has definite advantages over a machine with a fixed mounting surface as being adjustable means greater versatility in the test installation. For example, an adjustable mounting table that may be rotated relative to the axis of the centrifuge arm might allow a test installation of the type referred to above or allow a choice of more than one test item axis for exposure to the acceleration vector without detaching the test item to re-orientate it for each axis tested. Difficulties in such operations as installation, checkout, servicing, and removal of the test item can be reduced by using a mounting table that allows a change in position relative to the centrifuge arm.

The testing of small items, or items that are difficult to set up, may be expedited by using a fixture that allows exposure of each axis to the acceleration vector without removal of the test item from the fixture. In this procedure, the fixture (with the test item attached to it) is re-oriented. One of the simpler fixtures of this type holds the test item at a central location so that any number of fixture faces may be attached to the centrifuge mounting table depending upon the item orientation required. Installations of this type are usually bolted to the centrifuge. At centrifuge sites where numerous tests requiring re-orientation of the test object are conducted, fixture versatility means reduced costs in test programs and less time to complete tests.

The decision in favor of a particular fixture design may be affected by such considerations as:

- a. The scope of the test program.
- b. The complexity of test requirements.
- c. Physical characteristics of the test item.
- d. Centrifuge design.

The economics of conducting a centrifuge test are often primary considerations. If the test program is a large one requiring a test to be duplicated for a number of like test items, an elaborate fixture design that minimizes the installation and test time for each test item may be required. The design and cost of the fixture, in this case, might be justified by a reduction in the cost of the program such that the cost of fixture design and fabrication is a fraction of the total amount saved. Conversely, a small number of tests might be conducted more economically by using a simple installation in which the test item is unfastened from the centrifuge and re-orientated for each part of a test.

Knowledge of the ability of supporting bracketry to carry the required loads is an important factor in the preparation for a centrifuge test. A detailed analysis may not be necessary, if a previously used mounting bracket is to be exposed to loads known to be less severe than those for which it was designed; however, a preliminary design investigation, including a force and stress analysis, usually is required in conjunction with a new test installation. Basic forces imposed on the test item by centrifuge accelerations are shown in Figures 513.8A-1, 513.8A-2, and 513.8A-3.

Free-body diagrams showing the forces at critical locations under various load conditions are commonly used in making the force analysis. After the forces have been identified as to point of application, direction, and magnitude, the stress analysis is undertaken. The analysis may require consideration of as many as four separate loading cases: axial force, transverse force (shear), bending, and torsion. In a bracket under complex loading conditions, it is possible that more than one of these conditions will exist. Loading conditions, that appear to be relatively simple, are sometimes required to be broken down into idealized conditions. After each loading condition has been analyzed to determine stresses and deflections, the results are combined to determine total strength and deflection characteristics.

MIL-STD-810H
METHOD 513.8 ANNEX A

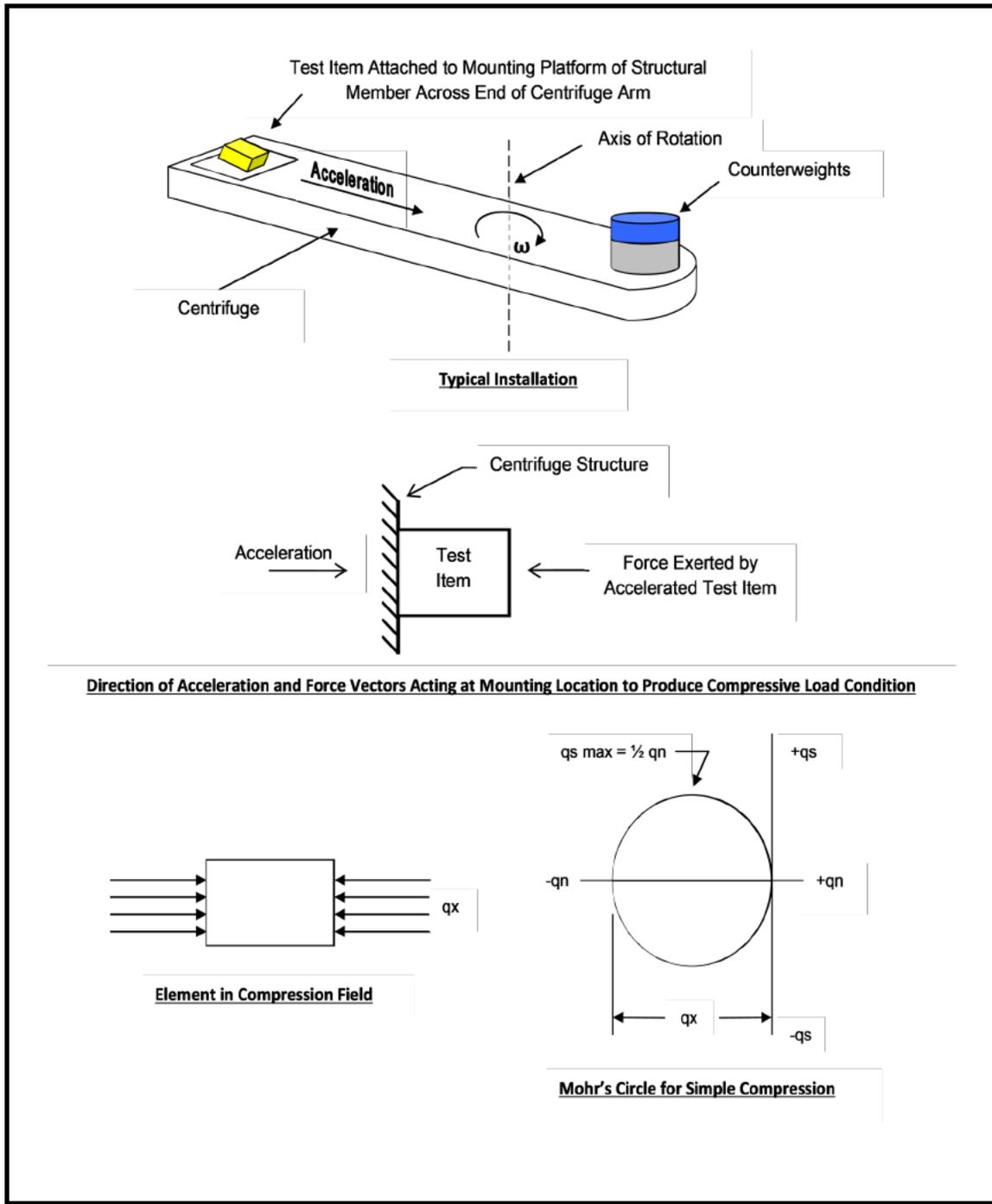


Figure 513.8A-1. Basic centrifuge test installation resulting in compressive load conditions.

MIL-STD-810H
METHOD 513.8 ANNEX A

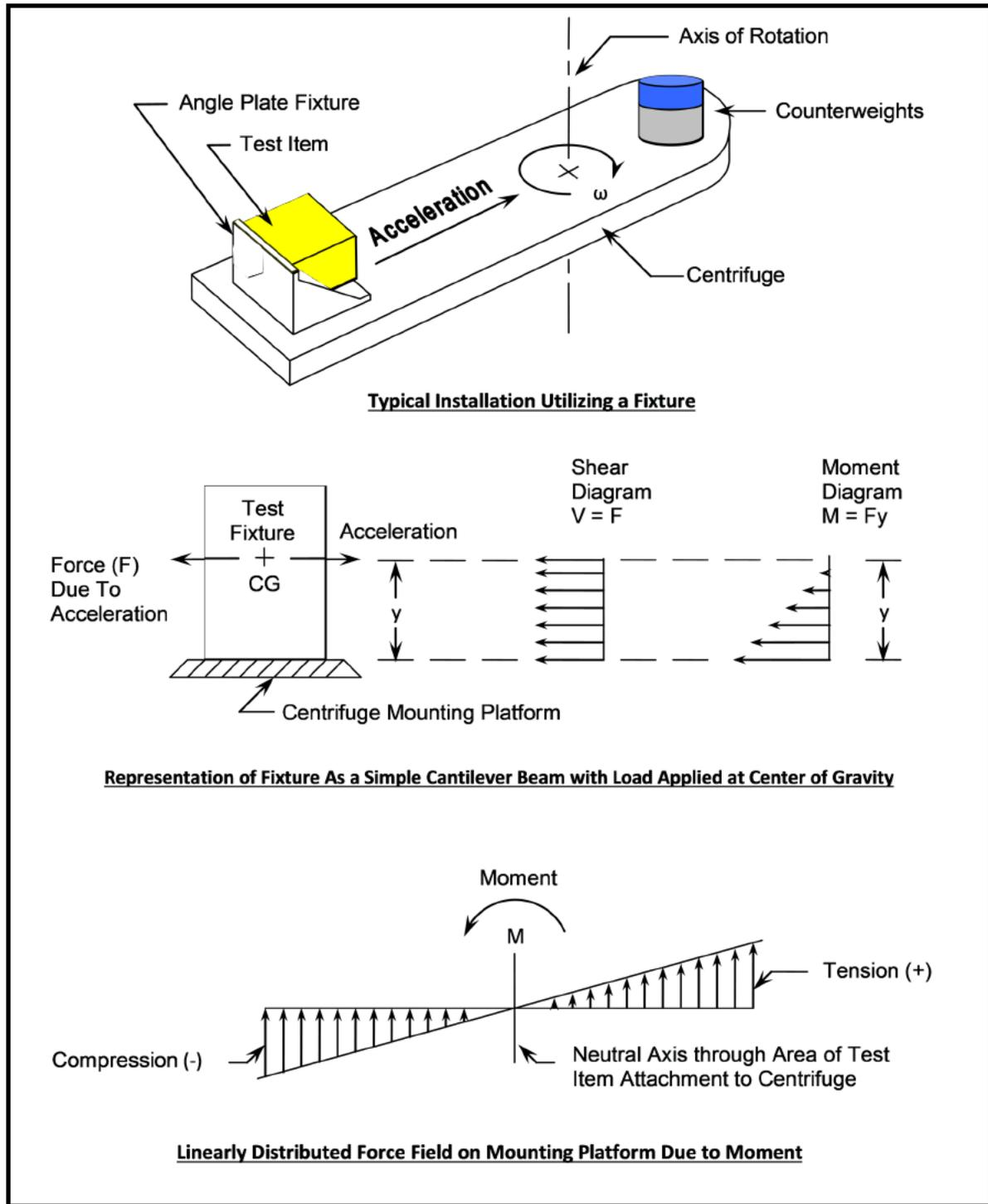
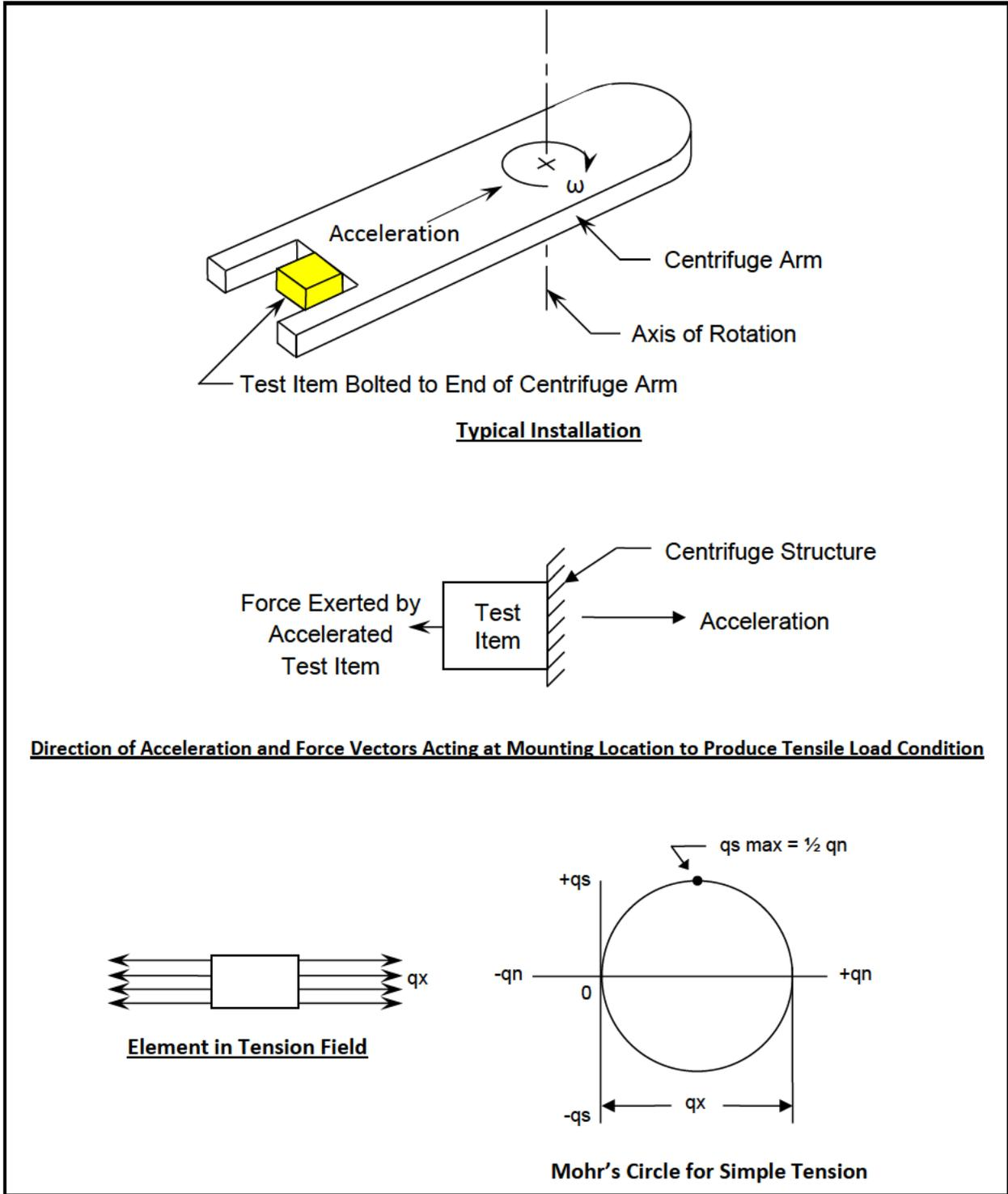


Figure 513.8A-2. A typical centrifuge test installation requiring consideration of moment effects in installation design.

MIL-STD-810H
METHOD 513.8 ANNEX A



513.8A-3. Basic centrifuge test installation resulting in tensile load conditions.

MIL-STD-810H
METHOD 513.8 ANNEX A

Occasionally, the design of a centrifuge test installation may require that the bracketry weight be kept at a minimum so that the total installation load does not exceed the centrifuge load limits. This, as in other areas of structural design, may require a careful investigation of various combinations of stress at critical locations. The complexity of the load conditions is dependent upon the centrifuge test requirements as well as the configuration of the test item and the bracketry by which the test item is attached to the centrifuge. Test conditions and the installation may be such that only simple bracketry loading involving shear, tension, or compression requires consideration, or the test may be such that various loading conditions exist with combined stresses that vary with time. An analysis of the more complex loading conditions may require investigation of the state of stress and strain, and the deflection due to distributed forces or force fields. The use of experimental, as well as analytical, analysis tools may be necessary to obtain an analysis in sufficient detail. Standard strength-of-materials references are adequate for most of the structural design required in conjunction with centrifuge testing. Some typical centrifuge test item installations and the basic bracketry load and stress considerations are shown in Figures 513.8A-1, 513.8A-2, and 513.8A-3.

1.2 Fixture Materials and Construction.

In selecting the material for a fixture, two important factors to be considered are the stress to which the fixture will be subjected, and the weight the centrifuge arm can support. Other factors that should be taken into account are machinability and fabrication qualities. The material giving the lowest cost, yet having the properties needed, generally is considered the best engineering material. However, test schedule and material availability influence the choice of materials to be used. Aluminum and magnesium combining lightness with good mechanical properties to give a high strength-to-weight ratio are frequently used for centrifuge test fixtures. Both metals are available in a variety of forms including standard sheet, plate, bar stock, and miscellaneous shapes, and both have generally desirable fabrication qualities. Most of the fusion and mechanical fastening methods common to the metal working trades may be used in the fabrication of fixtures, however, the designer should be aware of the characteristics of each material under his design conditions. Inserts may be used to reinforce the fixture base metal. In bolted connections, they increase the resistance to severe loading conditions and/or to thread wear due to repeated use of the fixture. A bolted fixture design may be found desirable because of the versatility of this fabrication method in new fixtures, as well as in the adaptation of fixtures previously used for other tests. The fixture may either bolt directly to the centrifuge platform or, if necessary, to an adapter plate that, in turn, is bolted to the centrifuge arm.

1.3 General Considerations in Centrifuge Testing.

Although testing by means of the centrifuge appears to be simple when compared with other types of testing, the test engineer may encounter numerous issues that vary in magnitude depending upon the complexity of the test. Typical issues encountered are those associated with the generation of required test conditions, data acquisition, test item servicing and handling, and miscellaneous support of the type supplied at the test site.

The generation of acceleration conditions other than those required at the test item location may be objectionable. An acceleration gradient along the axis of the centrifuge arm and a tangential acceleration exist at the test item location in varying degrees of intensity during the operation of a centrifuge.

Centrifugally-produced forces are not uniform along a test specimen on a centrifuge because of the proportionality of acceleration to the radius. The normal acceleration (along the length of the centrifuge arm) varies directly with the radius and by the square of the angular velocity ($a_n = r\omega^2$). The effect of the incremental variation of acceleration along the radius of a centrifuge arm may be undesirable if a test item is required to be subjected to an acceleration value within specified tolerances at more than one location, and test item dimensions along the centrifuge arm are such that the difference in acceleration between these locations is excessive. The importance of a centrifuge with a large radius is appreciated in such a situation, since the incremental variation of acceleration over the test item is less if the item was installed at the end of a centrifuge arm of greater length.

In tests requiring acceleration values to be maintained within close tolerances on a large object, it may be desirable to adjust the centrifuge rotational speed so the required acceleration is obtained at the location (radius of gyration) of a critical test item component.

The effect of tangential acceleration ($a_t = r\alpha$) on the resultant acceleration vector should not be overlooked. This acceleration occurs in a direction perpendicular to that of the normal acceleration, and may be large enough to cause a considerable change in direction and magnitude of the resultant acceleration vector. Because of centrifuge design and power requirements, the tangential acceleration usually encountered on a large centrifuge is relatively low. However, the tangential acceleration generated by changes in rotational speed of smaller centrifuges may become

MIL-STD-810H
METHOD 513.8 ANNEX A

significantly large. If test specifications require a rapid g level ramp rate within the limits attainable on a centrifuge, it may be necessary to provide a means of accounting for large tangential acceleration values at the test item location. There have been designs that allow the test item to be rotated relative to the centrifuge arm in such a way that the resultant of the normal and tangential acceleration vectors remains orientated along the desired axis of the test object during periods when a change in centrifuge rotational speed occurs. Figure 513.8A-4 depicts the forces due to rotation and change in rotational speed of the centrifuge.

2. FAILURE DETECTION PROBLEMS.

During a centrifuge test, the detection and analysis of the cause of failure may be difficult. For example, during a centrifuge test, an electronic circuit in a test item might fail due to a capacitor short. This failure might have occurred regardless of the test, or might have been a direct result of the test. Other possibilities exist and a conclusion that the capacitor failed as a result of the test is extremely uncertain without additional evidence. Careful technical consideration must be given to the cause and effect relationship of each failure to prevent erroneous conclusions and unnecessary redesign efforts. There is no definite procedure for failure investigation or troubleshooting; except that drawings, system specification documents, operating instructions, and good engineering practices should be used. Failure may be classified as intermittent, catastrophic, or fatigue. An intermittent failure is one that occurs during the test, but disappears when the test item returns to normal operation after the causative influence is removed. Catastrophic or fatigue failure is one that results in the structural failure of a component of the test item, and can be detected by inspection of instrumentation after the test is concluded.

3. ACCELERATION AND FORCE CALCULATION.

Figure 513.8A-4 depicts the forces due to rotation and change in rotational speed of the centrifuge.

MIL-STD-810H
METHOD 513.8 ANNEX A



<p>Acceleration</p> $a_R = \sqrt{a_t^2 + a_n^2}$	<p>a_R = resultant acceleration where normal and tangential acceleration exist</p> <p>a_t = $r\alpha$, tangential acceleration</p> <p>a_n = $r\omega^2$, normal acceleration</p> <p>α = change in centrifuge rotational acceleration (radians/second squared)</p> <p>ω = centrifuge rotational velocity (radians/second)</p>
<p>Force</p> $F_R = \sqrt{F_t^2 + F_c^2}$	<p>F_R = resultant force</p> <p>F_t = ma_t, force due to tangential acceleration</p> <p>F_c = ma_n, centrifugal force due to normal acceleration</p> <p>m = mass of the test item</p>
<p>General Expression*</p> $g's = \frac{\pi^2 N^2 r}{900G}$ <p>* Derived from equation for normal acceleration, $a_n = r\omega^2$</p>	<p>g = acceleration as a number of gravity units</p> <p>G = gravitational unit of acceleration (9.81 meter/sec² (32.2 ft/sec²))</p> <p>π = 3.14159</p> <p>N = revolutions per minute</p> <p>r = radius of gyration (feet or inches)</p>
<p>Centimeter Units</p> $g's = 0.1118 \times 10^{-4} r N^2$	<p>Inch Units</p> $g's = 0.2838 \times 10^{-4} r N^2$
<p>Meter Units</p> $g's = 0.1118 \times 10^{-2} r N^2$	<p>Feet Units</p> $g's = 0.3406 \times 10^{-3} r N^2$

Figure 513.8A-4. Basic forces imposed on test item due to accelerations produced by centrifuge.

MIL-STD-810H
METHOD 513.8 ANNEX A

(This page is intentionally blank.)

MIL-STD-810H
METHOD 514.8**METHOD 514.8****VIBRATION****CONTENTS**

<u>Paragraph</u>	<u>Page</u>
1. SCOPE.....	1
1.1 PURPOSE	1
1.2 APPLICATION	1
1.3 LIMITATIONS.....	4
2. TAILORING GUIDANCE.....	4
2.1 SELECTING THE METHOD.....	4
2.1.1 EFFECTS OF ENVIRONMENT	5
2.1.2 SEQUENCE.....	6
2.2 SELECTING PROCEDURES.....	6
2.2.1 PROCEDURE SELECTION CONSIDERATIONS	6
2.2.2 DIFFERENCE AMONG PROCEDURES.....	7
2.3 DETERMINE TEST LEVELS AND CONDITIONS.....	7
2.3.1 CLIMATIC CONDITIONS.....	7
2.3.2 TEST ITEM CONFIGURATION	8
2.3.3 MULTI EXCITER CONSIDERATION	8
2.4 TEST ITEM OPERATION.....	8
3. INFORMATION REQUIRED.....	8
3.1 PRETEST.....	9
3.2 DURING TEST.....	10
3.3 POST-TEST.....	10
4. TEST PROCESS.....	10
4.1 TEST FACILITY	10
4.1.1 PROCEDURE I - GENERAL VIBRATION.....	10
4.1.2 PROCEDURE II - LOOSE CARGO TRANSPORTATION	11
4.1.3 PROCEDURE III - LARGE ASSEMBLY TRANSPORT.....	11
4.1.4 PROCEDURE IV - ASSEMBLED AIRCRAFT STORE CAPTIVE CARRIAGE AND FREE FLIGHT	11
4.2 CONTROLS, TOLERANCES, AND INSTRUMENTATION.....	11
4.2.1 CONTROL STRATEGY	11
4.2.1.1 ACCELERATION INPUT CONTROL STRATEGY.....	11
4.2.1.2 FORCE CONTROL STRATEGY	12
4.2.1.3 ACCELERATION LIMIT STRATEGY	12
4.2.1.4 ACCELERATION RESPONSE CONTROL STRATEGY	12
4.2.1.5 WAVEFORM CONTROL STRATEGY	12
4.2.2 TOLERANCES.....	13
4.2.2.1 ACCELERATION SPECTRAL DENSITY	13
4.2.2.2 PEAK SINUSOIDAL ACCELERATION	15
4.2.2.3 FREQUENCY MEASUREMENT	16
4.2.2.4 CROSS AXIS ACCELERATIONS	16
4.2.3 INSTRUMENTATION	17
4.3 TEST INTERRUPTION.....	17
4.3.1 INTERRUPTION DUE TO LABORATORY EQUIPMENT MALFUNCTION.....	17

MIL-STD-810H
METHOD 514.8**CONTENTS - Continued**

<u>Paragraph</u>	<u>Page</u>
4.3.2	INTERRUPTION DUE TO TEST ITEM OPERATION FAILURE 18
4.3.3	INTERRUPTION DUE TO SCHEDULED EVENT 18
4.3.4	INTERRUPTION DUE TO EXCEEDING TEST TOLERANCES 18
4.4	TEST SETUP..... 19
4.4.1	PROCEDURE I - GENERAL VIBRATION..... 19
4.4.2	PROCEDURE II - LOOSE CARGO TRANSPORTATION..... 19
4.4.3	PROCEDURE III - LARGE ASSEMBLY TRANSPORT..... 19
4.4.4	PROCEDURE IV - ASSEMBLED AIRCRAFT STORE CAPTIVE CARRIAGE AND FREE FLIGHT..... 20
4.5	TEST EXECUTION..... 21
4.5.1	PREPARATION FOR TEST..... 22
4.5.1.1	PRELIMINARY STEPS..... 22
4.5.1.2	PRETEST STANDARD AMBIENT CHECKOUT..... 22
4.5.2	PROCEDURE I - GENERAL VIBRATION..... 22
4.5.3	PROCEDURE II - LOOSE CARGO TRANSPORTATION..... 23
4.5.4	PROCEDURE III - LARGE ASSEMBLY TRANSPORT..... 23
4.5.5	PROCEDURE IV - ASSEMBLED AIRCRAFT STORE CAPTIVE CARRIAGE AND FREE FLIGHT..... 24
5.	ANALYSIS OF RESULTS..... 26
5.1	PHYSICS OF FAILURE 26
5.2	QUALIFICATION TESTS 26
5.3	OTHER TESTS..... 26
6.	REFERENCE/RELATED DOCUMENTS 26
6.1	REFERENCED DOCUMENTS..... 26
6.2	RELATED DOCUMENTS..... 29

TABLE

TABLE 514.8-I	VIBRATION ENVIRONMENT CATEGORIES..... 3
TABLE 514.8-II	RANDOM VIBRATION TEST TOLERANCES 14
TABLE 514.8-III	SINUSOIDAL VIBRATION TEST TOLERANCES 16

**ANNEX A
ENGINEERING INFORMATION**

1.	SCOPE..... A-1
1.1	PURPOSE..... A-1
1.2	APPLICATION..... A-1
1.3	LIMITATIONS..... A-1
2.	ENGINEERING INFORMATION..... A-1
2.1	VIBRATION TEST TYPES..... A-1
2.1.1	DEVELOPMENT TEST..... A-1
2.1.2	QUALIFICATION TEST..... A-1
2.1.2.1	FUNCTIONAL TEST..... A-2
2.1.2.2	ENDURANCE TEST..... A-2
2.1.3	DURABILITY TEST..... A-2
2.1.4	RELIABILITY TEST..... A-2
2.1.4.1	STATISTICAL RELIABILITY TEST A-3
2.1.4.2	RELIABILITY GROWTH TEST A-3

MIL-STD-810H
METHOD 514.8

CONTENTS - Continued

<u>Paragraph</u>	<u>Page</u>
2.1.5	WORTHINESS TEST.A-3
2.1.6	ENVIRONMENTAL STRESS SCREENING (ESS).....A-3
2.2	TEST TIME COMPRESSION AND THE FATIGUE RELATIONSHIP.....A-3
2.3	VIBRATION CHARACTERIZATIONA-5
2.3.1	RANDOM VIBRATIONA-6
2.3.2	SINUSOIDAL VIBRATIONA-6
2.3.3	MIXED BROADBAND AND NARROWBAND VIBRATIONA-6
2.3.4	TRANSIENT VIBRATIONA-7
2.3.5	RANDOM VERSUS SINUSOIDAL VIBRATION EQUIVALENCEA-7
2.3.6	COMBINATION OF TEST SPECTRA.....A-7
2.4	PLATFORM/MATERIEL AND FIXTURE/TEST ITEM INTERACTIONA-7
2.4.1	MECHANICAL IMPEDANCE.....A-7
2.4.2	VIBRATION ISOLATIONA-8
2.4.3	MATERIEL RESONANT FREQUENCY VARIATIONA-8
2.5	MODAL TEST AND ANALYSIS.....A-8
2.5.1	MODAL TEST TECHNIQUESA-9
2.5.2	MATERIAL NON-LINEAR BEHAVIOR.....A-9
2.6	AERODYNAMIC EFFECTS.....A-9
2.6.1	DYNAMIC PRESSURE.....A-9
2.6.2	AIR SPEEDA-9
2.6.3	ALTITUDE.....A-10
2.7	SIMILARITYA-10
2.7.1	UNMODIFIED MATERIELA-10
2.7.2	MODIFIED MATERIEL.....A-10
2.7.3	EQUAL VIBRATION ENVIRONMENTA-11
2.7.4	RELIABILITY DATAA-11
2.7.5	CRITICAL RESONANT RESPONSEA-11
2.7.6	DYNAMIC SIMILARITYA-11

**ANNEX B
MANUFACTURE / MAINTENANCE
TAILORING GUIDANCE FOR VIBRATION EXPOSURE DEFINITION**

1.	SCOPEB-1
1.1	PURPOSE.B-1
1.2	APPLICATION.B-1
1.3	LIMITATIONS.....B-1
2.	MANUFACTURE/MAINTENANCE.....B-1
2.1	CATEGORY 1 – MANUFACTURING/MAINTENANCE PROCESSES.B-1
2.2	CATEGORY 2 – SHIPPING AND HANDLING.B-1
2.3	CATEGORY 3 – ENVIRONMENTAL STRESS SCREENING (ESS).....B-1

MIL-STD-810H
METHOD 514.8**CONTENTS - Continued**

<u>Paragraph</u>	<u>Page</u>
ANNEX C	
TRANSPORTATION	
TAILORING GUIDANCE FOR VIBRATION EXPOSURE DEFINITION	
1. SCOPE	C-1
1.1 PURPOSE	C-1
1.2 APPLICATION	C-1
1.3 LIMITATIONS	C-1
2. TRANSPORTATION	C-1
2.1 CATEGORY 4 – TRUCK/TRAILER – SECURED CARGO.....	C-2
2.1.1 CATEGORY 4 – TRUCK TRANSPORTATION OVER US HIGHWAYS.....	C-2
2.1.2 CATEGORY 4 – MISSION/FIELD TRANSPORTATION.....	C-2
2.1.3 CATEGORY 4 – EXPOSURE LEVELS	C-3
2.1.4 CATEGORY 4 – EXPOSURE DURATIONS.....	C-16
2.2 CATEGORY 5 - TRUCK/TRAILER - LOOSE CARGO	C-16
2.3 CATEGORY 6 - TRUCK/TRAILER - LARGE ASSEMBLY TRANSPORT.....	C-18
2.4 CATEGORY 7 - AIRCRAFT – JET	C-19
2.5 CATEGORY 8 - AIRCRAFT – PROPELLER	C-23
2.6 CATEGORY 9 - AIRCRAFT – HELICOPTER.....	C-27
2.7 CATEGORY 10 – WATERCRAFT – MARINE VEHICLES.....	C-31
2.8 CATEGORY 11 – RAILROAD - TRAIN.....	C-31

ANNEX C TABLES

TABLE 514.8C-I. CATEGORY 4 - COMMON CARRIER - BREAK POINTS FOR CURVES OF FIGURE 514.8C-2.....	C-5
TABLE 514.8C-II. CATEGORY 4 - COMMON CARRIER - BREAK POINTS FOR CURVES OF FIGURE 514.8C-3 (UNKNOWN OR VARIABLE TEST ITEM ORIENTATION).....	C-6
TABLE 514.8C-III. VEHICLES USED FOR TWO-WHEELED TRAILER COMPOSITE	C-7
TABLE 514.8C-IV. CATEGORY 4 - COMPOSITE TWO-WHEELED TRAILER VIBRATION EXPOSURE - BREAK POINTS FOR CURVES OF FIGURE 514.8C-4	C-9
TABLE 514.8C-V. CATEGORY 4 - COMPOSITE TWO-WHEELED TRAILER VIBRATION EXPOSURE - BREAK POINTS FOR CURVES OF FIGURE 514.8C-5 (UNKNOWN OR VARIABLE TEST ITEM ORIENTATION)	C-10
TABLE 514.8C-VI. VEHICLES USED FOR COMPOSITE WHEELED VEHICLE COMPOSITE	C-11
TABLE 514.8C-VII. CATEGORY 4 - COMPOSITE WHEELED VEHICLE VIBRATION EXPOSURE - BREAK POINTS FOR CURVES OF FIGURE 514.8C-6	C-14
TABLE 514.8C-VIII. CATEGORY 4 - COMPOSITE WHEELED VEHICLE VIBRATION EXPOSURE - BREAK POINTS FOR CURVES OF FIGURE 514.8C-7 (UNKNOWN OR VARIABLE TEST ITEM ORIENTATION)	C-15
TABLE 514.8C-IX. CATEGORY 7 - JET AIRCRAFT CARGO VIBRATION EXPOSURE - BREAK POINTS FOR FIGURE 514.8C-9.	C-20
TABLE 514.8C-X. CATEGORY 7 - JET AIRCRAFT VIBRATION EXPOSURE (SAME AS ANNEX D, TABLE 514.8D-I.).....	C-22
TABLE 514.8C-XI. CATEGORY 8 - PROPELLER AIRCRAFT VIBRATION EXPOSURE – 4-BLADED C-130.....	C-24
TABLE 514.8C-XII. CATEGORY 8 - PROPELLER AIRCRAFT VIBRATION EXPOSURE – 6-BLADED C-130.....	C-25
TABLE 514.8C-XIII. CATEGORY 8 - PROPELLER AIRCRAFT VIBRATION EXPOSURE – OTHER THAN C-130.....	C-26
TABLE 514.8C-XIVa. CATEGORY 9 – HELICOPTER PARAMETERS (SAME AS ANNEX D, TABLE 514.8D-IIIa.)	C-30
TABLE 514.8C-XIVb. CATEGORY 9 - HELICOPTER VIBRATION EXPOSURE (SAME AS ANNEX D, TABLE 514.8D-IIIb.).....	C-31

MIL-STD-810H
METHOD 514.8

CONTENTS - Continued

<u>Paragraph</u>	<u>Page</u>
ANNEX C FIGURES	
FIGURE 514.8C-1. CATEGORY 4 - TYPICAL MISSION / FIELD TRANSPORTATION SCENARIO.	C-2
FIGURE 514.8C-2. CATEGORY 4 - COMMON CARRIER - US HIGHWAY TRUCK VIBRATION EXPOSURE.	C-5
FIGURE 514.8C-3. CATEGORY 4 - COMMON CARRIER - US HIGHWAY TRUCK VIBRATION EXPOSURE. (UNKNOWN OR VARIABLE TEST ITEM ORIENTATION).....	C-6
FIGURE 514.8C-4. CATEGORY 4 - COMPOSITE TWO-WHEELED TRAILER VIBRATION EXPOSURE.	C-9
FIGURE 514.8C-5. CATEGORY 4 - COMPOSITE TWO-WHEELED TRAILER VIBRATION EXPOSURE. (UNKNOWN OR VARIABLE TEST ITEM ORIENTATION).....	C-10
FIGURE 514.8C-6. CATEGORY 4 - COMPOSITE WHEELED VEHICLE VIBRATION EXPOSURE.	C-14
FIGURE 514.8C-7. CATEGORY 4 - COMPOSITE WHEELED VEHICLE VIBRATION EXPOSURE. (UNKNOWN OR VARIABLE TEST ITEM ORIENTATION).....	C-15
FIGURE 514.8C-8. CATEGORY 5 - LOOSE CARGO TEST SETUP.	C-18
FIGURE 514.8C-9. CATEGORY 7 - JET AIRCRAFT CARGO VIBRATION EXPOSURE.	C-20
FIGURE 514.8C-10. CATEGORY 7 - JET AIRCRAFT VIBRATION EXPOSURE (SAME AS ANNEX D, FIGURE 514.8D-1.)	C-21
FIGURE 514.8C-11. CATEGORY 8 - PROPELLER AIRCRAFT VIBRATION EXPOSURE (4-BLADED C-130).....	C-24
FIGURE 514.8C-12. CATEGORY 8 - PROPELLER AIRCRAFT VIBRATION EXPOSURE (6-BLADED C-130).....	C-25
FIGURE 514.8C-13. CATEGORY 8 - PROPELLER AIRCRAFT VIBRATION EXPOSURE (OTHER THAN C-130).....	C-26
FIGURE 514.8C-14. CATEGORY 8 - PROPELLER AIRCRAFT VIBRATION ZONES.	C-27
FIGURE 514.8C-15. CATEGORY 9 - HELICOPTER VIBRATION EXPOSURE (SAME AS ANNEX D, FIGURE 514.8D-4.)	C-29
FIGURE 514.8C-16. CATEGORY 10 - HELICOPTER VIBRATION ZONES (SAME AS ANNEX D, FIGURE 514.8D-5.)	C-29
FIGURE 514.8C-17. CATEGORY 11 - RAIL CARGO VIBRATION EXPOSURE.	C-32

**ANNEX D
OPERATIONAL TAILORING GUIDANCE FOR VIBRATION EXPOSURE DEFINITION**

1. SCOPE	D-1
1.1 PURPOSE	D-1
1.2 APPLICATION	D-1
1.3 LIMITATIONS.....	D-1
2. OPERATIONAL SERVICE	D-1
2.1 CATEGORY 12 - FIXED WING AIRCRAFT - JET AIRCRAFT	D-1
2.2 CATEGORY 13 - PROPELLER AIRCRAFT.....	D-5
2.3 CATEGORY 14 - ROTARY WING AIRCRAFT - HELICOPTER.....	D-7
2.4 CATEGORY 15 - AIRCRAFT STORES - ASSEMBLED, JET AIRCRAFT.....	D-12
2.4.1 CATEGORY 15 - CAPTIVE FLIGHT - EXTERNAL CARRIAGE.....	D-12
2.4.2 CATEGORY 15 - CAPTIVE FLIGHT - INTERNAL CARRIAGE.....	D-14
2.4.3 CATEGORY 15 - FREE FLIGHT.....	D-14
2.4.4 CATEGORY 15 - EXPOSURE LEVELS.....	D-15
2.4.5 CATEGORY 15 - EXPOSURE DURATIONS	D-15
2.5 CATEGORY 16 - AIRCRAFT STORES - MATERIEL, JET AIRCRAFT.....	D-20
2.6 CATEGORY 17 - AIRCRAFT STORES - ASSEMBLED/MATERIEL, PROPELLER AIRCRAFT	D-20
2.7 CATEGORY 18 - AIRCRAFT STORES - ASSEMBLED/MATERIEL, HELICOPTER	D-21
2.8 CATEGORY 19 - MISSILES - TACTICAL MISSILES (FREE FLIGHT)	D-21
2.9 CATEGORY 20 - GROUND VEHICLES - GROUND MOBILE	D-21
2.10 CATEGORY 21 - WATERCRAFT - MARINE VEHICLES.	D-23
2.11 CATEGORY 22 - ENGINES - TURBINE ENGINES	D-24

MIL-STD-810H
METHOD 514.8**CONTENTS - Continued**

<u>Paragraph</u>	<u>Page</u>
ANNEX D	
OPERATIONAL TAILORING GUIDANCE FOR VIBRATION EXPOSURE DEFINITION	
2.12	CATEGORY 23 - PERSONNEL – MATERIEL CARRIED BY/ON PERSONNEL.....D-25

ANNEX D TABLES

TABLE 514.8D-I.	CATEGORY 12 - JET AIRCRAFT VIBRATION EXPOSURE. (SAME AS ANNEX C, TABLE 514.8C-X).....D-4
TABLE 514.8D-II.	CATEGORY 13 - PROPELLER AIRCRAFT VIBRATION EXPOSURED-6
TABLE 514.8D-IIIa	CATEGORY 14 - HELICOPTER PARAMETERS (SAME AS ANNEX C, TABLE 514.8C-XIVa).D-11
TABLE 514.8D-IIIb	CATEGORY 14 – HELICOPTER VIBRATION EXPOSURE (SAME AS ANNEX C, TABLE 514.8C-XIVb).....D-11
TABLE 514.8D-IV.	CATEGORY 15 - JET AIRCRAFT EXTERNAL STORE VIBRATION EXPOSURE.....D-16
TABLE 514.8D-V	DYNAMIC PRESSURE CALCULATIOND-18

ANNEX D FIGURES

FIGURE 514.8D-1.	CATEGORY 12 - FIXED WING AIRCRAFT – JET AIRCRAFT (SAME AS ANNEX C, FIGURE 514.8C-9).....D-3
FIGURE 514.8D-2.	CATEGORY 13 - PROPELLER AIRCRAFT VIBRATION EXPOSURED-6
FIGURE 514.8D-3.	CATEGORY 13 - PROPELLER VIBRATION ZONES.....D-7
FIGURE 514.8D-4.	CATEGORY 14 - HELICOPTER VIBRATION EXPOSURE.....D-10
FIGURE 514.8D-5.	CATEGORY 14 - HELICOPTER VIBRATION ZONES.D-12
FIGURE 514.8D-6.	CATEGORY 15 - JET AIRCRAFT STORE VIBRATION RESPONSE.....D-15
FIGURE 514.8D-7.	CATEGORY 15 - JET AIRCRAFT STORE BUFFET RESPONSED-17
FIGURE 514.8D-8.	DYNAMIC PRESSURE AS A FUNCTION OF MACH NUMBER AND ALTITUDED-19
FIGURE 514.8D-9.	CATEGORY 16 - JET AIRCRAFT STORE EQUIPMENT VIBRATION EXPOSURED-20
FIGURE 514.8D-10.	CATEGORY 20 - TRACKED VEHICLE REPRESENTATIVE SPECTRAL SHAPE.....D-22
FIGURE 514.8D-11.	CATEGORY 21 - SHIPBOARD RANDOM VIBRATION EXPOSURE.....D-24
FIGURE 514.8D-12.	CATEGORY 22 - TURBINE ENGINE VIBRATION EXPOSURED-25

ANNEX E**SUPPLEMENTAL TAILORING GUIDANCE FOR VIBRATION EXPOSURE DEFINITION**

1.	SCOPEE-1
1.1	PURPOSE E-1
1.2	APPLICATION E-1
1.3	LIMITATIONS..... E-1
2.	SUPPLEMENTAL TESTSE-1
2.1	SUPPLEMENTAL CONSIDERATIONS..... E-1
2.1.1	CATEGORY 24 - MINIMUM INTEGRITY TESTS E-1
2.1.2	CATEGORY 25 - ALL VEHICLES – CANTILEVERED EXTERNAL MATERIEL E-4

ANNEX E FIGURES

FIGURE 514.8E-1.	CATEGORY 24 – GENERAL MINIMUM INTEGRITY EXPOSURE. E-3
FIGURE 514.8E-2.	CATEGORY 24 – HELICOPTER MINIMUM INTEGRITY EXPOSURE..... E-4

MIL-STD-810H
METHOD 514.8

CONTENTS - Continued

<u>Paragraph</u>	<u>Page</u>
ANNEX F	
DEVELOPMENT OF LABORATORY VIBRATION TEST SCHEDULES	
1. GENERAL	F-1
2. REQUIREMENTS	F-1
3. DEFINITIONS	F-2
4. NATURE OF VIBRATION	F-2
5. PLATFORM SPECIFIC CONSIDERATIONS	F-3
5.1 ROAD TRANSPORT - WHEELED VEHICLE	F-3
5.2 ROAD TRANSPORT - TRACKED VEHICLE	F-3
5.3 AIR TRANSPORT - ROTOR WING	F-4
5.4 AIR TRANSPORT - FIXED WING	F-4
5.5 SEA TRANSPORT	F-4
5.6 RAIL TRANSPORT	F-5
6. DATA COLLECTION, REVIEW AND SELECTION	F-5
7. SCENARIO DEVELOPMENT.....	F-5
7.1 GROUND VEHICLE.....	F-5
7.1.1 BETA DISTRIBUTION	F-8
7.2 AIRCRAFT	F-10
7.3 SEA VEHICLE	F-11
7.4 RAIL TRANSPORT	F-11
8. VSD ALTERNATIVES	F-11
9. VSD PROCEDURES	F-11
9.1 VSD CONSIDERATIONS.....	F-11
9.2 ENGINEERING DATA COMMON ACROSS VSD METHODS	F-12
9.2.1 MINER-PALMGREN HYPOTHESIS.....	F-12
9.2.1.1 S/N CURVE	F-12
9.2.1.2 MINER-PALMGREN EQUATIONS.....	F-13
10. PREDICTIONS OF MAXIMUM RESPONSE	F-19
11. SUMMARY AND CONCLUSION	F-20

ANNEX F TABLES

TABLE 514.8F-I. LIFETIME SCENARIO BREAKOUT – EXAMPLE ONLY	F-7
TABLE 514.8F-II. SELECTION OF ALPHA FOR BETA DISTRIBUTION	F-8
TABLE 514.8F-III. DEFAULT VALUES FOR M	F-16
TABLE 514.8F-IV. METALS AND MATERIAL PROPERTIES	F-18

ANNEX F FIGURES

FIGURE 514.8F-1. SAMPLE BETA DISTRIBUTION (WHEELED VEHICLE).....	F-9
FIGURE 514.8F-2. S/N CURVE	F-13
FIGURE 514.8F-3. TYPICAL STRAIN LIFE CURVE.....	F-14
FIGURE 514.8F-4. RELATIVE DAMAGE AS A FUNCTION OF SURFACE FINISH – SAE-8630 STEEL.....	F-15
FIGURE 514.8F-5. RELATIVE DAMAGE AS A FUNCTION OF STRAIN RANGE – SAE 8630 STEEL.	F-16
FIGURE 514.8F-6. TYPICAL S-N CURVE	F-19

MIL-STD-810H
METHOD 514.8**CONTENTS - Continued**

<u>Paragraph</u>	<u>Page</u>
ANNEX F APPENDICIES	
APPENDIX A. PREPARATION FOR VSD - DATA ACQUISITION.....	F-A1
1. INTRODUCTION	F-A1
2. VEHICLE PREPARATION FOR DATA ACQUISITION - CARGO	F-A1
2.1 SPECIFIED LOAD	F-A1
2.2 GENERAL CARGO SIMULATED LOAD	F-A1
2.3 TIE-DOWN	F-A1
2.4 ACCELEROMETERS.....	F-A1
3. VEHICLE PREPARATION FOR DATA ACQUISITION – INSTALLED EQUIPMENT	F-A1
4. DATA ACQUISITION PROCEDURE	F-A2
4.1 DATA ACQUISITION	F-A2
4.2 CARGO SCHEDULES	F-A2
4.3 INSTALLED EQUIPMENT SCHEDULES.....	F-A2
5. DATA REQUIRED	F-A2
APPENDIX B. COMBINATION OF SPECTRA (STATISTICAL)	F-B1
1. COMBINING SPECTRA.....	F-B1
1.1 AUTO AND CROSS SPECTRAL DENSITIES.....	F-B1
1.2 CONFIDENCE INTERVAL OF ASD ESTIMATES.....	F-B2
2. STATISTICAL CONSIDERATIONS FOR DEVELOPING LIMITS ON AN ENSEMBLE OF DATA.....	F-B3
2.1 BASIC ESTIMATE ASSUMPTIONS	F-B3
2.2 BASIC ESTIMATE SUMMARY PREPROCESSING.....	F-B4
2.3 PARAMETRIC UPPER LIMIT STATISTICAL ESTIMATE ASSUMPTIONS.....	F-B4
2.3.1 NTL - UPPER NORMAL ONE-SIDED TOLERANCE LIMIT	F-B5
2.3.2 NPL - UPPER NORMAL PREDICTION LIMIT	F-B6
2.4 NONPARAMETRIC UPPER LIMIT STATISTICAL ESTIMATE ASSUMPTIONS.....	F-B6
2.4.1 ENV – UPPER LIMIT	F-B6
2.5 DFL – UPPER DISTRIBUTION-FREE TOLERANCE LIMIT.....	F-B7
2.6 ETL – UPPER EMPIRICAL TOLERANCE LIMIT	F-B7
2.7 EXAMPLE FROM MEASURED DATA	F-B8
3. COMMON ANALYSIS FUNCTIONS AND STATISTICAL DEFINITIONS OF VSD DATA ENSEMBLES	F-B9
ANNEX F, APPENDIX B TABLES	
TABLE 514.8F-B.I. NORMAL TOLERANCE FACTORS FOR UPPER TOLERANCE LIMIT	F-B6
ANNEX F, APPENDIX B FIGURES	
FIGURE 514.8F-B.1. 90-PERCENT CONFIDENCE LIMITS FOR $n_d = 31$ LINEAR SPECTRAL AVERAGES.	F-B3
FIGURE 514.8F-B.2. EXAMPLE NORMAL TOLERANCE LIMIT APPLIED TO TYPICAL WHEELED VEHICLE DATA	F-B8
FIGURE 514.8F-B.3. AVERAGE, AVERAGE PLUS STANDARD DEVIATION, AND PEAK SPECTRA.....	F-B10
FIGURE 514.8F-B.4. COMBINATION OF 24 INDIVIDUAL SPECTRA.....	F-B11

MIL-STD-810H
METHOD 514.8**CONTENTS - Continued**

<u>Paragraph</u>	<u>Page</u>
ANNEX F, APPENDIX B FIGURES	
FIGURE 514.8F-B.5. COMPARISON OF RESULTANT TEST SPECTRUM TO ENVELOPE OF INDIVIDUAL SPECTRA.....	F-B12
APPENDIX C. COMBINATION OF SPECTRA (FATIGUE DAMAGE SPECTRA)	F-C1
1. FATIGUE DAMAGE SPECTRUM METHOD OF COMBINING SPECTRA.....	F-C1
2. EXAMPLE APPLICATION OF FATIGUE DAMAGE SPECTRUM.....	F-C2
3. FDS APPROACH TO DEVELOPMENT OF A LVTS.....	F-C9
ANNEX F, APPENDIX C TABLES	
TABLE 514.8F-C.I. TEST COURSE LENGTHS, SPEEDS AND EXPOSURE TIMES	F-C2
ANNEX F, APPENDIX C FIGURES	
FIGURE 514.8F-C.1. FATIGUE DAMAGE SPECTRA FOR SPECIFIC TEST COURSES.	F-C3
FIGURE 514.8F-C.2. CUMULATIVE FATIGUE DAMAGE SPECTRUM	F-C4
FIGURE 514.8F-C.3. CUMULATIVE FATIGUE SPECTRA FROM LOCATIONS 1 AND 2	F-C5
FIGURE 514.8F-C.4. COMBINED VIBRATION POWER SPECTRA DEVELOPED FROM AVERAGE AND MAXIMUM FATIGUE DAMAGE SPECTRA.....	F-C6
FIGURE 514.8F-C.5. COMPARISON OF COMBINED VIBRATION POWER SPECTRUM DEVELOPED FROM THE FATIGUE DAMAGE SPECTRUM, FROM THE STATISTICAL PROCESS AND FROM AN ENVELOPE PROCESS.....	F-C7
FIGURE 514.8F-C.6. FATIGUE DAMAGE SPECTRA FOR TWO EXPONENTS.....	F-C8
FIGURE 514.8F-C.7. COMPARISON OF COMBINED VIBRATION POWER SPECTRA DEVELOPED FROM TWO EXPONENTS	F-C9
FIGURE 514.8F-C.8. TIME COMPRESSION OF ASD'S COMPUTED FROM THE INVERSE CUMULATIVE FATIGUE DAMAGE SPECTRUM	F-C10
APPENDIX D. VIBRATION SPECIFICATION DEVELOPMENT PROCEDURE.....	F-D1
1. INTRODUCTION.....	F-D1
2. BROADBAND PROFILE DEVELOPMENT	F-D2
2.1 FILE SETUP (STEP 1).....	F-D2
2.2 SELECT EVENT START AND END TIME (STEP 2).....	F-D3
2.3 TIME BLOCK DROP (STEP 3)	F-D3
2.4 CALCULATE ASD AVERAGE (STEP 4).....	F-D3
2.5 SPECTRAL SPIKE REMOVAL (STEP 5).....	F-D4
2.6 SCENARIO TABLE (STEP 6).....	F-D6
2.7 CALCULATE WEIGHTED ASD (STEP 7)	F-D9
2.8 CALCULATE WEIGHTED INTERMEDIATE LVTS (STEP 8).....	F-D10
3. NARROWBAND RANDOM SPECIFICATION DEVELOPMENT PROCEDURE.....	F-D11
4. SINE TONE SPECIFICATION DEVELOPMENT PROCEDURE	F-D13
5. ALTERNATE BROADBAND DEVELOPMENT BASED ON FATIGUE DAMAGE SPECTRUM	F-D15
6. FINAL DEVELOPMENT PROCEDURES.....	F-D16
7. COMBINING LVTS	F-D16

MIL-STD-810H
METHOD 514.8**CONTENTS - Continued**

<u>Paragraph</u>	<u>Page</u>
ANNEX F, APPENDIX D TABLES	
TABLE 514.8F-D.I. REQUIRED PARAMETERS	F-D2
TABLE 514.8F-D.II. SINGLE-EVENT ASD SUM-SET.....	F-D4
TABLE 514.8F-D.III. SPECTRAL SPIKE REMOVED TABLE, AVERAGE	F-D6
TABLE 514.8F-D.IV. SCENARIO TABLE INPUT	F-D7
TABLE 514.8F-D.V. RUNTIME CALCULATION.....	F-D8
TABLE 514.8F-D.VI. GROUP SUM-SET DEFINITION	F-D9
TABLE 514.8F-D.VII. NARROWBAND RANDOM CALCULATIONS	F-D12
TABLE 514.8F-D.VIII. SINE TONE CALCULATIONS.....	F-D14
TABLE 514.8F-D.IX. LVTS COMBINATION EXAMPLE	F-D17
ANNEX F, APPENDIX D FIGURES	
FIGURE 514.8F-D.1. VSD FLOWCHART	F-D1
FIGURE 514.8F-D.2. SPECTRAL SPIKE REMOVAL WINDOW	F-D5
APPENDIX E. THEORETICAL ASPECTS OF MAXIMUM RESPONSE	F-E1
1. INTRODUCTION	F-E1
2. SINUSOIDAL EXCITATION	F-E1
3. SWEPT SINE EXCITATION.....	F-E2
4. RANDOM VIBRATION EXCITATION.....	F-E2
ANNEX F, APPENDIX E FIGURES	
FIGURE 514.8F-E.1. MRS FOR A FIXED SINE EXCITATION AT 500 HZ WITH Q=5	F-E2
FIGURE 514.8F-E.2. MRS FOR A SWEPT SINE FROM 300 HZ TO 1200 HZ.....	F-E2
FIGURE 514.8F-E.3. MRS FOR A RANDOM VIBRATION	F-E3
APPENDIX F. ANNEX F REFERENCES	F-F1

MIL-STD-810H
METHOD 514.8

METHOD 514.8

VIBRATION

NOTE: Tailoring is essential. Select methods, procedures, and parameter levels based on the tailoring process described in Part One, paragraph 4, and Part One, Annex C. Apply the general guidelines for laboratory test methods described in Part One, paragraph 5 of this standard. **For vibration schedule development**, see Annex F.

The vibration profiles provided in Annexes B through E of this Method are default curves that are generally developed as a composite of multiple locations acquired from multiple vehicles of a similar construct. For technical guidance / contact information regarding the existence and availability of either item-specific or location-specific vibration profiles that may reside in various archives, see Part One, page iii, for Service points-of-contact. In addition, Test Operations Procedure (TOP) 01-2-601 (paragraph 6.1, reference d), includes an assortment of specific ground vehicle vibration data and TOP 01-2-603 (paragraph 6.1 reference xx) includes several specific helicopter vibration data.

Organization. The main body of this Method is arranged similarly to the other methods of MIL-STD-810H. A considerable body of supplementary information is included in the Annexes. With the exception of Table 514.8-I, all tables and figures for the entire method are in Annexes B through F. Annex A provides definitions and engineering guidance useful in interpreting and applying this Method. Annexes B through F provide guidance for estimating vibration levels and durations and for selection of test procedures. Reference citations to external documents are at the end of the main body (paragraph 6). **It is highly recommended that users read Annex A before applying the vibration schedules in Annexes B through E or the vibration schedule development process in Annex F.** The Annexes are as follows:

ANNEX A – ENGINEERING INFORMATION

ANNEX B – MANUFACTURE / MAINTENANCE TAILORING GUIDANCE FOR VIBRATION EXPOSURE DEFINITION

ANNEX C – TRANSPORTATION TAILORING GUIDANCE FOR VIBRATION EXPOSURE DEFINITION

ANNEX D – OPERATIONAL TAILORING GUIDANCE FOR VIBRATION EXPOSURE DEFINITION

ANNEX E – SUPPLEMENTAL TAILORING GUIDANCE FOR VIBRATION EXPOSURE DEFINITION

ANNEX F – DEVELOPMENT OF LABORATORY VIBRATION TEST SCHEDULES

1. SCOPE.

1.1 Purpose.

The purpose of this Method is to provide guidance for defining vibration environments materiel may be exposed to throughout a life cycle and to provide guidance for the conduct of laboratory vibration tests. Vibration tests are performed to:

- a. Develop materiel to function in and withstand the vibration exposures of a life cycle including synergistic effects of other environmental factors, materiel duty cycle, and maintenance.
- b. Verify that materiel will function in and withstand the vibration exposures of a life cycle.

1.2 Application.

- a. **General.** Use this Method for all types of materiel except as noted in Part One, paragraph 1.3, and as stated in paragraph 1.3 below. For combined environment tests, conduct the test in accordance with the applicable test documentation. However, use this Method for determination of vibration test levels, durations, data reduction, and test procedure details.
- b. **Purpose of test.** The test procedures and guidance herein are adaptable to various test purposes including development, reliability, qualification, etc. See Annex A for definitions and guidance.

MIL-STD-810H
METHOD 514.8

- c. Vibration life cycle. Table 514.8-I provides an overview of various life cycle situations during which some form of vibration may be encountered, along with the anticipated platform involved. Annex A provides definitions and engineering guidance useful in interpreting and applying this Method. Annexes B - E provide guidance for estimating vibration levels and durations and for selection of test procedures. Test Operations Procedure (TOP) 01-2-601 (paragraph 6.1, reference d), includes an assortment of specific ground vehicle data. TOP 01-2-603 (paragraph 6.1, reference xx) includes a few specific helicopter profiles and will be updated as more data become available.
- d. Manufacturing. The manufacture and acceptance testing of materiel involves vibration exposures. These exposures are not directly addressed herein. It is assumed that materiel undergoes environmental testing during the manufacturing and acceptance process and this process produces the same environmental damage for any deliverable materiel. Thus the tests described in this Method are designed to verify the field life of the delivered materiel. When a change is made to the manufacturing process that involves increased vibration exposure, evaluate this increased vibration exposure to ensure the field life of subsequent materiel is not shortened. An example might be pre-production materiel completely assembled in one building, whereas production units are partially assembled at one site and then transported to another site for final assembly. Changes in the manufacturing vibration environment should be evaluated with regard to the need for design and (re)qualification. (See Annex B)
- e. Environmental Stress Screening (ESS). Many materiel items are subjected to ESS, burn-in, or other production acceptance test procedures prior to delivery to the government, and sometimes during maintenance. As in basic production processes, it is assumed that both the test units and the field units receive the same vibration exposures, so that environmental test results are valid for the field units. Where units do not necessarily receive the same exposures, such as multiple passes through ESS, apply the maximum allowable exposures to the items used for environmental test as pre-conditioning for the environmental tests. (See Annex A, paragraph 2.1.6, and Annex B, paragraph 2.3.)

MIL-STD-810H
METHOD 514.8**Table 514.8-I. Vibration environment categories.**

Life Phase	Platform	Category	Materiel Description	Annex	Test ¹		
Manufacture / Maintenance	Plant Facility / Maintenance Facility	1. Manufacture / Maintenance processes	Materiel / Assembly / Part	B	2		
		2. Shipping, handling			2		
		3. ESS			3		
Transportation	Trucks and Trailers	4. Secured Cargo	Materiel as secured cargo ⁴	C	I		
		5. Loose Cargo	Materiel as loose cargo ⁴		II		
		6. Large Assembly Transport	Large assemblies, shelters, van and trailer units ⁴		III		
	Aircraft	7. Jet	Materiel as cargo		I		
		8. Propeller					
		9. Helicopter					
	Watercraft ⁵	10. Marine Vehicles					
Railroad	11. Train						
Operational	Aircraft	12. Jet		Installed Materiel		D	I
		13. Propeller					
		14. Helicopter					
	Aircraft Stores	15. Jet	Assembled stores	IV			
		16. Jet	Installed in stores	I			
		17. Propeller	Assembled / Installed in stores	IV/I			
		18. Helicopter					
	Missiles	19. Tactical Missiles	Assembled / installed in missiles (free flight)				
	Ground	20. Ground Vehicles	Installed Materiel in wheeled / tracked / trailer	I/III			
	Watercraft ⁵	21. Marine Vehicles	Installed Materiel	I			
Engines	22. Turbine Engines	Materiel Installed on Engines					
Personnel	23. Personnel	Materiel carried by/on personnel	2				
Supplemental	All	24. Minimum Integrity	Installed on Isolators / Life cycle not defined	E	I		
	All Vehicles	25. External Cantilevered	Antennae, airfoils, masts, etc.		2		

¹ Test procedure – see paragraph 4.
² See Annexes B, C, D, & E, and the paragraphs related to categories identified in the “Category” column. It is highly recommended that users read Annex A before applying Annex B, C, D and E vibration schedules
³ Refer to the applicable ESS procedure (for additional guidance see Annex A, Paragraph 2.1.6).
⁴ See paragraph 2.3.2 below.
⁵ For Navy vessels, see Method 528.1.

MIL-STD-810H
METHOD 514.8

1.3 Limitations.

- a. Safety testing. This Method may be used to apply specific safety test requirements as coordinated with the responsible safety organization. However, vibration levels or durations for specific safety related issues are not provided or discussed.
- b. Platform/materiel interaction. In this Method, vibration requirements are generally expressed as inputs to materiel that is considered to be a rigid body with respect to the vibration exciter (platform, shaker, etc.). While this is often not true, it is an acceptable simplification for smaller materiel items. This method does not attempt to address the validity of this assumption and leaves it to the user to determine proper treatment of a given materiel item/platform. The guidance below addresses typical platform/material interaction scenarios. Additional discussion of platform/materiel interaction is provided in Annex A, paragraph 2.4.
 - (1) Where impedance mismatch between platform/materiel and laboratory vibration exciter/test item are significantly different, force control or acceleration limiting control strategies may be required to avoid unrealistically severe vibration response (see paragraph 4.2). The use of control limits should be based upon field data measurements and the sensitivity of the materiel to excessive vibratory loading (e.g., a resonance condition).
 - (2) In certain cases in which the field measured response is well defined on a small component and the duration of the vibration is short, execution of the laboratory test under open loop waveform control based upon the field measured data is an option.
 - (3) For large materiel items, it is necessary to recognize that the materiel and the exciter vibrate as a single flexible system and may be difficult to control as a laboratory vibration test. An example is a shelter transported to the field as a pre-assembled office, laboratory, etc. A suitable test for such systems would be the large assembly transport test (Procedure III) of paragraph 4.4.3.
 - (4) Proper treatment of a given materiel item may vary throughout the life cycle. An example might be a galley designed for an aircraft. For the operational environment (installation on an operating aircraft), consider the galley structure as aircraft secondary structure, and design and test accordingly. Design subassemblies within the galley (e.g., coffee maker) for vibration levels based on guidance of Annex D, and tested in accordance with Procedure I. When packaged for shipment, the packaging, galley, and subassemblies are considered a single materiel item, and tested accordingly.
- c. Environmental Stress Screening (ESS). This Method does not contain guidance for selection of ESS exposures. Some discussion is in Annex A, paragraph 2.1.6, and Annex B, paragraph 2.3.
- d. Multiple Exciter Testing. This Method is limited to consideration of one mechanical degree-of-freedom based on a spectral reference. Refer to Method 527 for further guidance on multiple exciter testing, and Method 525 for time waveform replication.
- e. Synergistic Effects. Combine the guidance of this Method with the guidance of Part One and other methods herein to account for environmental synergism.

2. TAILORING GUIDANCE

2.1 Selecting this Method.

Essentially all materiel will experience vibration, whether during manufacture, transportation, maintenance, or operational use. The procedures of this Method address most of the life cycle situations during which vibration is likely to be experienced. Select the procedure or procedures most appropriate for the materiel to be tested and the environment to be simulated. See Table 514.8-I for a general listing of vibration exposures and test procedures as related to environmental life cycle elements. See Annexes B-F for guidance on determining vibration levels and durations.

- a. Fidelity of the laboratory test environment. As noted in Part I (Paragraph 1.3), laboratory test methods are limited in their abilities to simulate synergistic or antagonistic stress combinations, dynamic (time

MIL-STD-810H
METHOD 514.8

sequence) stress applications, aging, and other potentially significant stress combinations present in natural field/fleet service environments. Use caution when defining and extrapolating analyses, test criteria, and results. An assessment of the test article vulnerabilities should be used to determine the environmental variables that are essential to the laboratory test and potential for increased margin to compensate for deficiencies in the test environment. Reduction in test environment fidelity may lead to an increased risk to material life and function in the fielded environment.

- b. Conservatism with measured data. The guidance in this document encourages the use of materiel-specific measured data as the basis for vibration criteria. Due to limitations in numbers of transducers, accessibility of measurement points, linearity of data at extreme conditions, and other causes, measurements do not include all extreme conditions. Further, there are test limitations such as single axis versus multi-axis, and practical fixtures versus platform support. Apply margin to measured data in deriving test criteria to account for these variables. When sufficient measured data are available, use statistical methods as shown in Annex F.
- c. Conservatism with default or enveloped data. Annexes B - E of this Method provide information that can be used to generate default criteria for those cases where measured data are unavailable. These data are based on envelopes of wide ranges of cases and are conservative for any one case. Additional margin is not recommended. Use caution when conducting vibration test with default or enveloped vibration data if non-linear behavior is expected or observed at full test level. If non-linear behavior is a concern, a ramp up step should be added to the test schedule. The vibration amplitude of this additional ramp up step shall have an exaggeration factor of unity. This unity ramp up step duration should be at least 10 minutes. The data measured during full test level and the unity ramp up step can be used to evaluate the linearity of the materiel during accelerated test. If materiel is determined to behave non-linearly using the above technique, the organization responsible for the materiel under test shall be notified. Test options should be explored and a proposed path forward should be identified. The test options and proposed path forward should be sent to the appropriate test authority for concurrence prior to proceeding.

NOTE: The materiel's anticipated Life Cycle Environmental Profile (LCEP) may reveal other vibration scenarios that are not specifically addressed in the procedures. Tailor the procedures as necessary to capture the LCEP variations, but do not reduce the basic test requirements reflected in the below procedures without proper justification. (See paragraph 2.3 below.)

2.1.1 Effects of environment.

Vibration results in dynamic deflections of and within materiel. These dynamic deflections and associated velocities and accelerations may cause or contribute to structural fatigue and mechanical wear of structures, assemblies, and parts. In addition, dynamic deflections may result in impacting of elements and/or disruption of function. Some typical symptoms of vibration-induced problems follow. This list is not intended to be all-inclusive:

- a. Chafed wiring.
- b. Loose fasteners/components.
- c. Intermittent electrical contacts.
- d. Electrical shorts.
- e. Deformed seals.
- f. Failed components.
- g. Optical or mechanical misalignment.
- h. Cracked and/or broken structures.
- i. Migration of particles and failed components.
- j. Particles and failed components lodged in circuitry or mechanisms.

MIL-STD-810H
METHOD 514.8

- k. Excessive electrical noise.
- l. Fretting corrosion in bearings.

2.1.2 Sequence.

Use the anticipated life cycle sequence of events as a general sequence guide (see Part One, paragraph 5.5).

- a. General. The accumulated effects of vibration-induced stress may affect materiel performance under other environmental conditions such as temperature, altitude, humidity, leakage, or electromagnetic interference (EMI/EMC). When evaluating the cumulative environmental effects of vibration and other environments, expose a single test item to all environmental conditions, with vibration testing generally performed first. If another environment (e.g., temperature cycling) is projected to produce damage that would make the materiel more susceptible to vibration, perform tests for that environment before vibration tests. For example, thermal cycles might initiate a fatigue crack that would grow under vibration or vice versa.
- b. Unique to this Method. Generally, expose the test item to the sequence of individual vibration tests that follow the sequence of the life cycle. For most tests, this can be varied if necessary to accommodate test facility schedules, or for other practical reasons. Complete all manufacture associated preconditioning (including ESS) before any of the vibration tests. Complete any maintenance associated preconditioning (including ESS) prior to tests representing mission environments. Perform tests representing critical end-of-mission environments last.

2.2 Selecting Procedures.

Identify the environments of the materiel life cycle during the tailoring process as described in Part One, paragraph 4. Table 514.8-I provides a list of vibration environments by category versus test procedure. Descriptions of each category listed in this table are included in Annexes B - E, along with information for tailoring the test procedures of paragraph 4 below, and alternate test criteria for use when measured data are not available. In general, test the materiel for each category to which it will be exposed during an environmental life cycle. Tailor test procedures to best accomplish the test purpose (see Annex A, paragraph 2.1), and to be as realistic as possible (see Annexes B-E, paragraphs 1.2).

2.2.1 Procedure selection considerations.

Vibration test profiles may be omitted from an overall test series depending on relative profile severity. Profile severity comparisons shall include fatigue damage potential (test duration and bandwidth), vibration amplitude, and spectral content within the profile bandwidth. Analytical estimates of fatigue damage potential should be made on the basis of simple, well-understood models of the materiel, when and if possible.

Another method for reducing test duration is through a combination of spectra techniques. Combinations of random vibration test profiles may be performed if the reference spectra and bandwidths are similar by either employing the fatigue damage spectrum (FDS) or via statistical methods (refer to Annex F). Combination of vibration tests should not be performed with dissimilar spectra or spectra with dissimilar bandwidths. Examples of dissimilar spectra are random, sine, sine on random, sweeping sine on random, or sweeping random on random. For example, combining a broadband random (e.g. wheeled vehicle) spectrum with a sine-on-random spectrum (e.g. helicopter) should be avoided. Observe that the FDS example provided in Annex F is quite liberal in combining spectral shapes. Factors such as vibration magnitudes and unit under test (UUT) robustness should always be considered in establishing combined spectra based requirements.

Extreme caution should be used if test schedule compression is used to combine tests. Too much compression could result in entering non-linear regions of mechanical response which is undesirable. Highly conservative specifications with no correlation to actual discrete environmental conditions can lead to unnecessary overdesign. Furthermore, combining spectra can result in the inability to relate a failure mechanism to a discrete vibration environment. Finally, careless combination of spectra has the potential to yield a test that is difficult to conduct and control. Additionally, enveloping or combining spectra could result in the loss of vehicle anti-resonances which may be necessary for laboratory replication. These considerations are especially important for multi-axis test setups and profile definitions.

In evaluation of the relative severity of environments, include the differences in transportation configuration (packaging, shoring, folding, etc.) and application configuration (mounted to platform, all parts deployed for service,

MIL-STD-810H
METHOD 514.8

etc.). In addition, transportation environments are usually defined as inputs to the packaging, whereas application environments are expressed as inputs to the materiel mounting structure or as response of the materiel to the environment.

- a. Transportation vibration more severe than application environment. Transportation vibration levels are often more severe than application vibration levels for ground-based and some shipboard materiel. In this case, both transportation and platform vibration tests are usually needed because the transportation test is performed with the test item non-operating, and the platform test is performed with the test item operating.
- b. Application vibration more severe than transportation vibration. If the application vibration levels are more severe than the transportation levels, it may be feasible to delete transportation testing. It may also be feasible to change the application test spectrum shape or duration to include transportation requirements in a single test. In aircraft applications, a minimum integrity test (see Annex E, paragraph 2.1) is sometimes substituted for transportation and maintenance vibration requirements.
- c. Any omission or combination of spectra techniques employed should be agreed to by the responsible test authority prior to the conduct of testing and should be thoroughly documented in the test report.

2.2.2 Difference among procedures.

- a. Procedure I - General Vibration. Use Procedure I for materiel to be transported as secured cargo or deployed for use on a vehicle. This procedure applies to ground vehicles as well as fixed and rotary wing aircraft. For this procedure, the test item is secured to a vibration exciter, and vibration is applied to the test item as an input at the fixture/test item interface. Steady state or transient vibration may be applied as appropriate.
- b. Procedure II - Loose Cargo Transportation. Use this procedure for materiel to be carried in/on trucks, trailers, or tracked vehicles and not secured to (tied down in) the carrying vehicle. The test severity is not tailorable, and represents loose cargo transport in military vehicles traversing rough terrain.
- c. Procedure III - Large Assembly Transportation. This procedure is intended to replicate the vibration and shock environment incurred by large assemblies of materiel installed or transported by wheeled or tracked vehicles. It is applicable to large assemblies or groupings forming a high proportion of vehicle mass, and to materiel forming an integral part of the vehicle. In this procedure, use the specified vehicle type to provide the mechanical excitation to the test materiel. The vehicle is driven over surfaces representative of service conditions, resulting in realistic simulation of both the vibration environment and the dynamic response of the test materiel to the environment. Generally, measured vibration data are not used to define this test. However, measured data are often acquired during this test to verify that vibration and shock criteria for materiel subassemblies are realistic.
- d. Procedure IV - Assembled Aircraft Store Captive Carriage and Free Flight. Apply Procedure IV to fixed wing aircraft carriage and free flight portions of the environmental life cycles of all aircraft stores, and to the free flight phases of ground or sea-launched missiles. Use Procedure I, II, or III for other portions of the store's life cycle as applicable. Steady state or transient vibration may be applied as appropriate. Do not apply Procedure I to fixed wing aircraft carriage or free flight phases.

2.3 Determine Test Levels and Conditions.

Select excitation form (steady state or transient), excitation levels, control strategies, durations and laboratory conditions to simulate the vibration exposures of the environmental life cycle as accurately as possible. Whenever possible, acquire measured data as a basis for these parameters. Annexes B - E include descriptions of various phases typical of an environmental life cycle, along with discussions of important parameters and guidance for developing test parameters. Annex A has further guidance in interpretation of technical detail.

2.3.1 Climatic conditions.

Many laboratory vibration tests are conducted under standard ambient test conditions as discussed in Part One, paragraph 5. However, when the life cycle events being simulated occur in environmental conditions significantly different than standard conditions, consider applying those environmental factors during vibration testing. Individual climatic test methods (Methods 501.6 and 502.6) of this Standard include guidance for determining levels of other

MIL-STD-810H
METHOD 514.8

environmental loads. For temperature-conditioned environmental tests, (high temperature tests of explosive or energetic materials in particular), consider the materiel degradation due to extreme climatic exposure to ensure the total test program climatic exposure does not exceed the life of the materiel. (See Part One, paragraph 5.19.)

2.3.2 Test item configuration.

Configure the test item for each test as it will be in the corresponding life cycle phase. In cases representing transportation, include all packing, shoring, padding, or other configuration modifications of the particular shipment mode. The transportation configuration may be different for different modes of transportation.

- a. Loose cargo. The procedure contained herein is a general representation based on experience as well as measurement, and is not tailorable (see Annex C, paragraph 2.2 for details). The most realistic alternative for truck, trailer, or other ground transportation is to use Procedure II that requires the transportation vehicle and a full cargo load. In this test, the cargo has freedom to bounce, scuff and collide with other cargo and with the sides of the vehicle. The loose cargo environment includes conditions experienced by cargo transported in a vehicle traversing irregular surfaces. This test replicates the repetitive impact environment incurred by cargo transported under these conditions.
- b. Secured cargo. Procedure I assumes no relative motion between the vehicle cargo deck or cargo compartment and the cargo. This applies directly to materiel that is tied down or otherwise secured such that no relative motion is allowed considering vibration, shock, and acceleration loads. When restraints are not used or are such as to allow limited relative motions, provide allowance in the test setup and in the vibration excitation system to account for this motion. Procedure III is an alternative for ground transportation.
- c. Stacked cargo. Stacking or bundling of sets or groups of materiel items may affect the vibration transmitted to individual items. Ensure the test item configuration includes appropriate numbers and groupings of materiel items.

2.3.3 Multiple Exciter Consideration.

Method 527.1 addresses scenarios in which the test item size requires use of more than one exciter or test fidelity requires more than one mechanical degree-of-freedom. In general, if a test facility has the capability to address more than one mechanical degree-of-freedom, and if such testing can be conducted in a time and cost effective manner, multiple axis testing should be considered as a test option. If the default curves provided within various categories of Method 514.8 are used as reference curves in a multiple-axis test, it should be recognized that Cross Spectral Density (CSD) terms will be undefined. Method 527 recommends that the coherence terms be near zero. Some reduction in levels (e.g., lower conservatism factors) may be justified if it can be shown that the multiple degree-of-freedom (MDOF) test produces significantly higher stress levels or lower fatigue life than the sequential single degree-of-freedom (SDOF) tests.

2.4 Test Item Operation.

Where vibration tests are conducted to determine operational capability while exposed to the environment, operate the test item during the vibration test. Otherwise, verify operation before and after the vibration test. Use caution when applying combined or enveloped vibration profiles during operational tests as the levels may not be representative of any particular operational environment. During operational vibration tests, monitor and record sufficient data to define the achieved performance and sensitivity of the materiel to the vibration environment. See Annex A, paragraph 2.1.2.1 for additional functional test considerations.

3. INFORMATION REQUIRED.

The following information is required to conduct and document vibration tests adequately. Tailor the lists to the specific circumstances, adding or deleting items as necessary. Although generally not required in the past, perform fixture and materiel modal surveys when practical. These data are useful in evaluating test results, and in evaluating the suitability of materiel against changing requirements or for new applications. These data can be particularly valuable in future programs where the major emphasis will be to use existing materiel in new applications. (When

MIL-STD-810H
METHOD 514.8

modal survey is ruled out for programmatic reasons, a simple resonance search can sometimes provide useful information.)

3.1 Pretest.

The following information is required to conduct vibration tests adequately.

- a. General. See Part One, paragraphs, 5.7 and 5.9, and Part One, Annex A, Task 405 of this Standard.
- b. Specific to this Method (applicable to Procedures I through IV).
 - (1) Test schedule(s) and duration of exposure(s).
 - (2) Locations and specifications for all control and/or response transducers.
 - (3) Test equipment limitations. Assure that test requirements (force, acceleration, velocity, displacement) can be met. Seek approval for variation if required. Document any variation.
 - (4) Test shutdown procedures for test equipment or test item problems, failures, etc. (See paragraph 4.3).
 - (5) Test interruption recovery procedure. (See paragraph 4.3).
 - (6) Test completion criteria.
 - (7) Allowable adjustments to test item & fixture (if any); these must be documented in test plan and the test report.
- c. Tailoring. Necessary variations in the basic test parameters/testing materials to accommodate LCEP requirements and/or facility limitations.
- d. Specific to Procedure.
 - (1) Procedure I and IV- General and captive carriage/free flight vibration.
 - i. Test fixture requirements.
 - ii. Test fixture modal survey requirements / procedure.
 - iii. Test item / fixture modal survey requirements / procedure.
 - iv. Vibration exciter control strategy.
 - v. Test tolerances.
 - vi. Test temperature conditioning requirements.
 - vii. Combined environment requirements (e.g., temperature, humidity).
 - viii. Axes of exposure.
 - (2) Procedure II - Loose cargo vibration.
 - i. Orientation of test item(s) in relation to the axis of throw of the test table
 - ii. Number of possible test item orientations.
 - iii. Test time per orientation.
 - iv. Test item temperature conditioning requirements.
 - v. Test fixture requirements.
 - (3) Procedure III - Large assembly transport.
 - i. Test vehicle(s).
 - ii. Vehicle load configuration(s).
 - iii. Required road surface(s).
 - iv. Required distance(s) on each road surface.
 - v. Required speed(s) on each road surface.
 - vi. Vehicle suspension configuration(s) i.e., tire pressures (or Central Tire Inflation System

MIL-STD-810H
METHOD 514.8

(CTIS) settings), suspension settings (as applicable) etc.

NOTE: Modal surveys of both test fixtures and test items can be extremely valuable. Large test items on large complex fixtures are almost certain to have fixture resonances within the test range. These resonances may result in significant overtests or undertests at specific frequencies and locations within a test item. Where fixture and test item resonances couple, the result can be catastrophic. Similar problems often occur with small test items, even when the shaker/fixture system is well designed because it is very difficult and often impractical to achieve a lowest fixture resonant frequency above 2000 Hz. In cases where the fixture/item resonance coupling cannot be eliminated, consider special vibration control techniques such as acceleration or force limit control.

3.2 During Test.

Document the following information during conduct of the test:

- a. Collect the information listed in Part One, paragraph 5.10, and in Part One, Annex A, Tasks 405 and 406 of this Standard. Document any adjustments to the test item and fixture identified by the test plan, including planned stopping points. (See also paragraph 4.3.)
- b. Document the vibration exciter control strategy used, e.g., single point response, multipoint response, force limit, waveform, etc.
- c. Refer to the test-specific plan to address any additional data that may be required during the test phase.

3.3 Post-Test.

The following post test data, if applicable, shall be included in the test report.

- a. General. See Part One, paragraph 5.13, and Part One, Annex A, Task 406 of this Standard.
- b. Specific to this Method.
 - (1) Summary and chronology of test events, test interruptions, and test failures.
 - (2) Discussion and interpretation of test events.
 - (3) Functional verification data.
 - (4) Test item modal analysis data.
 - (5) All vibration measurement data.
 - (6) Documentation of any test requirement variation (paragraph 3.1 b (7))
 - (7) Any changes from the original test plan.
 - (8) Record of combined environment parameters (i.e., temperature and humidity).

4. TEST PROCESS.

Tailor the following paragraphs as appropriate for the individual program.

4.1 Test Facility.

Use a test facility, including all auxiliary equipment, capable of providing the specified vibration environments and the control strategies and tolerances discussed in paragraph 4.2. In addition, use measurement transducers, data recording and data reduction equipment capable of measuring, recording, analyzing, and displaying data sufficient to document the test and to acquire any additional data required. Unless otherwise specified, perform the specified vibration tests and take measurements at standard ambient conditions as specified in Part One, paragraph 5.1.

4.1.1 Procedure I - General vibration.

This procedure uses standard laboratory vibration exciters (shakers), slip tables, and fixtures. Choose the specific exciters to be used based on:

- a. the size and mass of test items and fixtures;

MIL-STD-810H
METHOD 514.8

- b. the frequency range required;
- c. the force, acceleration, velocity, and displacement required.

4.1.2 Procedure II - Loose cargo transportation.

Simulation of this environment requires use of a package tester (Annex C, Figure 514.8C-8) that imparts a 25.4 mm (1.0 inch) peak-to-peak, circular synchronous motion to the table at a frequency of 5 Hz. This motion takes place in a vertical plane. The figure shows the required fixturing. This fixturing does not secure the test item(s) to the bed of the package tester. Ensure the package tester is large enough for the specific test item(s) (dimensions and weight).

4.1.3 Procedure III - Large assembly transport.

The test facility for this Procedure is a test surface(s) and vehicle(s) representative of transportation and/or service phases of the environmental life cycle. The test item is loaded on the vehicle and secured or mounted to represent the life cycle event. The vehicle is then driven over the test surface in a manner that reproduces the transportation or service conditions. The test surfaces may include designed test tracks (e.g., test surfaces at the US Army Aberdeen Test Center (paragraph 6.1, reference b), typical highways, or specific highways between given points (e.g., a specified route between a manufacturing facility and a military depot)). Potentially, such testing can include all environmental factors (vibration, shock, temperature, humidity, pressure, etc.) related to wheeled vehicle transport.

4.1.4 Procedure IV - Assembled aircraft store captive carriage and free flight.

This procedure uses standard laboratory vibration exciters (shakers) driving the test item directly or through a fixture. The test item is supported by a test frame independent of the vibration exciters (see paragraph 4.4.4). Select the specific exciters based on size and mass of test items and fixtures, frequency range, and low frequency stroke length (displacement) required.

4.2 Controls, Tolerances, and Instrumentation.

The accuracy in providing and measuring vibration environments is highly dependent on fixtures and mountings for the test item, the measurement system and the exciter control strategy. Ensure all instrumentation considerations are in accordance with the best practices available (see paragraph 6.1, reference c). Careful design of the test set up, fixtures, transducer mountings and wiring, along with good quality control will be necessary to meet the tolerances of paragraph 4.2.2 below.

4.2.1 Control strategy.

For Procedures I and IV, select a control strategy that will provide the required vibration at the required location(s) in or on the test item. Base this selection on the characteristics of the vibration to be generated and platform/materiel interaction (see paragraph 1.3b above and Annex A, paragraph 2.4). Generally, a single strategy is appropriate. There are cases where multiple strategies are used simultaneously.

4.2.1.1 Acceleration input control strategy.

The vibration excitation is controlled to within specified bounds by sampling the vibratory motion of the test item at specific locations. These locations may be at, or in close proximity to, the test item fixing points (controlled input) or at defined points on the test item (controlled response). The vibratory motions may be sampled at a single point (single point control), or at several locations (multi-point control). The control strategy will be specified in the Test Plan. However, it should be noted that it could be influenced by:

- a. The results of preliminary vibration surveys carried out on materiel and fixtures;
- b. Meeting the test specifications within the tolerances of paragraph 4.2.2;
- c. The capability of the test facility.

In view of the possibility of frequency drift, it is essential when conducting fixed frequency sinusoidal "resonance dwell" tests that the frequency be constantly adjusted to ensure a maximum response. Two methods are available:

- a. Search for the maximum dynamic response;
- b. Maintain the phase between the control and monitoring points.

MIL-STD-810H
METHOD 514.8**4.2.1.1.1 Single Point Control Option**

This option can be used when the preliminary vibration survey indicates a rigid vibration fixture, or when one control accelerometer accurately represents an average of the inputs at each fixing point. However, given the increased risk associated with transducer or instrumentation failure and/or calibration or scaling error attributable to a single channel, this option is not recommended. A single control point is selected:

- a. Either from among the fixing points;
- b. Or, in such a way that it provides the best possible solution for achieving the tolerances at the fixing points.

4.2.1.1.2 Multiple Point Control (average) Option.

This option can be used when the preliminary vibration survey shows that inputs to the test item vary significantly between fixing points. The control points, usually two or three, will be selected using the same criteria listed in paragraph 4.2.1.1.1 for the single control point option. However, the control for:

- a. Random will be based on the average of the ASD of the control points selected.
- b. Sine will be based on the average of the peak response values of the control points selected.

4.2.1.1.3 Multiple Point Control (maximum) Option

This option can be used when responses are not to exceed given values, but care is needed to avoid an undertest. Preliminary vibration survey results are used to aid the definition of the control points on the test item at which maximum response motions occur. The control points, usually two or three, will be selected using the same criteria listed in paragraph 4.2.1.1.1 for the single point option. However, the control for:

- a. Random, will be based on the maximum spectrum response at any of the selected control points.
- b. Sine, will be based on the maximum peak response at any of the selected control points.

4.2.1.2 Force control strategy.

Dynamic force gages are mounted between the exciter/fixture and the test item. Exciter motion is controlled with feedback from the force gages to replicate field measured interface forces. This strategy is used where the field (platform/materiel) dynamic interaction is significantly different from the laboratory (exciter/test item) dynamic interaction. This form of control inputs the correct field-measured forces at the interface of the laboratory vibration exciter and test item. This strategy is used to prevent overtest or undertest of materiel mounts at the lowest structural resonances that may otherwise occur with other forms of control.

4.2.1.3 Acceleration limit strategy.

Input vibration criteria are defined as in paragraph 4.2.1.1. In addition, vibration response limits at specific points on the materiel are defined (typically based on field measurements). Monitoring transducers (typically accelerometers or strain gages) are located at these points. The test item is excited as in paragraph 4.2.1.1 using test item mounting point accelerometer signals to control the exciters. The input criteria are experimentally modified as needed to limit responses at the monitoring transducers to the predefined limits. Changes to the specified input criteria are limited in frequency bandwidth and in level to the minimum needed to achieve the required limits.

4.2.1.4 Acceleration response control strategy.

Vibration criteria are specified for specific points on, or within the test item. Control accelerometers are mounted at the vibration exciter/fixture interface. Monitoring accelerometers are mounted at the specified points within the item. Low level vibration, controlled with feedback from the control accelerometers is input to the test item. The input vibration is experimentally adjusted until the specified levels are achieved at the monitoring accelerometers. This strategy is commonly used with assembled aircraft stores where store response to the dynamic environment is measured or estimated. It is also applicable for other materiel when field measured response data are available.

4.2.1.5 Waveform control strategy.

This strategy is discussed in Methods 525.1 and 527.1.

MIL-STD-810H
METHOD 514.8**4.2.2 Tolerances.**

Use the following tolerances unless otherwise specified. In cases where these tolerances cannot be met, achievable tolerances should be established and agreed to by the cognizant engineering authority and the customer prior to initiation of test. Protect measurement transducer(s) to prevent contact with surfaces other than the mounting surface(s).

4.2.2.1 Acceleration spectral density.

The test facility should be capable of exciting the test item to the random vibration conditions specified in the Test Plan. The motion induced by the random vibration should be such that the fixing points of the test item move substantially parallel to the axis of excitation. In these conditions the amplitudes of motion should exhibit a normal distribution. The tolerances defined in Table 514.8-II below should be used and checked with the test item installed. The tolerances associated with the test severity parameters are not to be used to overtest or undertest the test item. Any deviations to the test or test tolerances from the values in Table 514.8-II must be approved by the appropriate test authority and must be clearly documented. In addition to the tolerances specified in Table 514.8-II, the following factors should also be considered:

- a. Vibration environment. The following discussion relates the measured vibration level to the specification level and, like the control system, does not consider any measurement uncertainty. The test tolerance should be kept to the minimum level possible considering the test item, fixturing and spectral shape. Test tolerances of less than ± 3 dB are usually readily attainable with small, compact test items (such as small and medium sized rectangular electronic packages), well-designed fixtures, and modern control equipment. When test items are large or heavy, when fixture resonances cannot be eliminated, or when steep slopes (>20 dB/octave) occur in the spectrum, these tolerances may have to be increased. When increases are required, exercise care to ensure the selected tolerances are the minimum attainable, and that attainable tolerances are compatible with test objectives.
- b. Vibration measurement. Use a vibration measurement system that can provide acceleration spectral density measurements within ± 0.5 dB of the vibration level at the transducer mounting surface (or transducer target mounting surface) over the required frequency range. Do not use a measurement bandwidth that exceeds 2.5 Hz at 25 Hz or below, or 5 Hz at frequencies above 25 Hz. Use a frequency resolution appropriate for the application (i.e., generally in wheeled vehicles a resolution of 1 Hz is sufficient).
- c. Statistical degrees of freedom. Since the control loop time depends on the number of degrees of freedom and on the analysis and overall bandwidths, it is important to select these parameters so that test tolerances and control accuracy can be achieved. If possible, ensure the number of statistical degrees of freedom is greater than 120. Swept narrow-band random on random vibration tests may require lesser degrees of freedom due to sweep time constraints.
- d. Root mean square (RMS) "g." Do not use RMS g as the sole parameter defining or controlling vibration tests because it contains no spectral information. RMS levels are useful in monitoring vibration tests since RMS can be monitored continuously, whereas measured spectra are available on a delayed, periodic basis. Also, RMS values are sometimes useful in detecting errors in test spectra definition. Do not use random vibration RMS g as a comparison with sinusoidal peak g. These values are unrelated.
- e. When possible, an identical analysis bandwidth should be used for both control and monitoring. When this is not possible, adequate allowance should be made to the results of the monitoring analysis.
- f. For swept narrow band random tests, the tolerances on the swept components of the test requirement should, wherever possible, be the same as for a wide band random component. However, at some sweep rates, these tolerances may not be achievable. Therefore, the tolerance requirements for these components shall be stated in the Test Plan.
- g. The complete test control system including checking, servoing, recording, etc., should not produce uncertainties exceeding one third of the tolerances listed in Table 514.8-II.

MIL-STD-810H
METHOD 514.8

- h. The tolerances associated with the test severity parameters are not to be used to overtest or undertest the test item. If tolerances are not met, the difference observed should be noted in the test report.

Table 514.8-II. Random Vibration Test Tolerances.

Specific Tolerances For All Random Vibration Tests (including the broadband component of mixed random and sinusoidal vibration tests and the fixed and swept narrowband components of mixed broadband and narrowband random vibration tests)		
Parameter	Tolerance	
Number (n) of independent statistical degrees of freedom (DOF) for control of the specified ASD.	n > 120	
Composite Control: Maximum deviation of the composite control ASD in relation to the specified ASD. ¹	± 3 dB below 500 Hz ± 6 dB above 500 Hz ± 10% overall grms	
Multi-point Control: Maximum deviation of any individual control channel ASD in relation to the specified ASD. ²	Average Control ± 6 dB below 500 Hz ± 9 dB above 500 Hz ± 25% overall grms	Extremal Control - 6 dB / + 3 dB below 500 Hz - 9 dB / + 6 dB above 500 Hz ± 25% overall grms
Cross-axis Motion: ASD measured with the same number of DOF as in the test axis, along the mutually orthogonal directions, in relation to the in-axis specified ASD.	Less than 50% below 500 Hz Less than 100% above 500 Hz Less than the relevant specified ASD for the given cross-axis.	
Frequency sweep rate	± 10% of stated rate	
Test time duration	± 5% of stated duration	
Amplitude distribution of the instantaneous values of the random vibration measured at the drive signal.	Nominally Gaussian (Refer to paragraph 2.4 for amplitude distribution discussion)	

¹ Composite Control is defined as: The ASD computed as either the average, maximum, or minimum (depending on control method) of all feedback channels deemed as control channels in a multi-point control scenario or the single control channel in a single-point control scenario. As discussed in paragraph 4.2.1.1 multi-point control is encouraged.

² If using minimum control, the negative tolerance will be that of the Composite Control.

The default assumption for all ASD references provided in this document is that the associated probability density function (pdf) is of Gaussian form. Generally, unless documentation from field data indicates otherwise, the drive-limiting option (often referred to as three-sigma clipping) should not be invoked. However, it is recognized that there are scenarios such as test equipment displacement limitations or power amplifier voltage or current limitations that could be resolved by invoking the drive limiting control parameter. When invoking the drive signal limiting feature on a Gaussian drive signal, the limiting threshold should never be set to less than three standard deviations (3-sigma). In addition, the test engineer or program engineer responsible for the test article should approve the operation and it should be properly documented within the test report.

When an ASD is being generated to serve as a reference for a vibration test, careful examination of field measured response probability density information should be performed. The probability density/distribution function should be estimated and compared with that of a theoretical Gaussian probability density/distribution. If there is strong evidence of departure from the Gaussian distribution then an accurate estimate of the higher moments – primarily kurtosis and skewness should be made, cognizant of the substantial increased amount of measurement information needed to estimate higher order moments accurately. Skewness and kurtosis are the third and fourth standardized moments about the mean computed as:

MIL-STD-810H
METHOD 514.8

$$\text{Skewness} = E \left[\frac{(x - \mu)^3}{\sigma^3} \right] \quad \text{and} \quad \text{Kurtosis} = E \left[\frac{(x - \mu)^4}{\sigma^4} \right], \text{ where}$$

E = expectation operator
 x = individual acceleration values
 μ = mean acceleration value
 σ = acceleration standard deviation

A Gaussian process has a skewness equal to 0 and a kurtosis equal to 3. Skewness is a measure of the asymmetry of the probability distribution of a random variable while kurtosis is a measure of “peakedness” or “flatness” of the distribution.

If analysis shows the data to be highly non-Gaussian, one may consider either of the following:

- (1) Employing TWR techniques (that will generally preserve the measured pdf and the distribution in time of the time history characteristics e.g., peaks and valleys, that provide for kurtosis differing from the Gaussian theoretical value).
- (2) Employing a control algorithm capable of drive signal synthesis per user defined kurtosis and “matching” the measurement pdf within some level of statistical confidence. All control systems do not necessarily assume the same model for generating non-Gaussian input and most control system software ignore the form of the pdf. Use of a control system that does not take account of the form of the pdf is discouraged unless it can be demonstrated that the pdf of the synthesized data is comparable (via statistical test) to that of the measured data upon which the test reference is based. This assumes a single measured test reference with non-Gaussian behavior. When several measured test references are present the overall non-Gaussian behavior may be due to “mixture distribution” effects, in which case an analyst must be consulted for recommendations as to a way to proceed.

In the event TWR or user defined kurtosis options as defined above are employed to address non-Gaussian scenarios, the time compression techniques outlined in Annex A paragraph 2.2 are not applicable.

The test engineer or program engineer responsible for the test article should approve any deviation from the standard Gaussian process and any deviations should be properly documented within the test report by time history plots, skewness/kurtosis estimates and probability density function estimate plots.

4.2.2.2 Peak sinusoidal acceleration.

The test facility should be able to excite the materiel as specified in the Test Plan. The motion should be sinusoidal and such that the fixing points of the test item move substantially in phase with and parallel to the excitation axis. The sinusoidal tolerances and related characteristics defined in Table 514.8-III should be used and checked with the test item installed. Only under exceptional circumstances should a Test Plan need to specify different tolerances. The complete test control system should not produce uncertainties exceeding one third of the tolerances listed in Table 514.8-III. The tolerances associated with the test severity parameters are not to be used to overttest or undertest the test item. If tolerances are not met, the difference observed should be noted in the test report.

MIL-STD-810H
METHOD 514.8**Table 514.8-III. Sinusoidal Vibration Test Tolerances.**

Specific Tolerances For All Sinusoidal Tests (including fixed, swept and stepped sine tests as well as the fixed and swept sinusoidal components of mixed random and sinusoidal tests)		
Parameter	Tolerance	
Frequency	± 0.1 %	
Composite Control: Maximum deviation of the composite control ¹ tone level(s) in relation to the specified tone level(s).	± 10%	
Multi-point Control: Maximum deviation of the individual control channel tone levels in relation to the specified tone level(s). ²	Average Control ± 25% below 500 Hz ± 50% above 500 Hz	Maxi Control +10% / -25% below 500 Hz +10% / -50% above 500Hz
Cross-axis Motion: Tone levels measured along the mutually orthogonal directions, in relation to the in-axis specified level(s).	Less than 50% below 500 Hz Less than 100% above 500 Hz Less than the relevant specified levels for the given cross-axis.	
Frequency sweep rate	± 10% of stated rate	
Test time duration	± 5% of stated duration	
Difference between the unfiltered signal and filtered acceleration signal ³	± 5% on the grms values ⁴	

¹ Composite Control is defined as: The Line Spectrum computed as either the average, maximum, or minimum (depending on control method) of all feedback channels deemed as control channels in a multi-point control scenario or the single control channel in a single-point control scenario. As discussed in paragraph 4.2.1.1

² If using minimum control, the negative tolerance will be that of the Composite Control.

³ Distortion of the sinusoidal signal can occur particularly when using hydraulic actuators. If distortion of the sinusoidal signal is suspected, the unfiltered signal and filtered acceleration signal should be compared. A signal tolerance of ±5 percent corresponds to a distortion of 32 percent by utilization of the formula:

$$d = \frac{\sqrt{a_{tot}^2 - a_1^2}}{a_1} \times 100$$

where: a_1 = grms value of acceleration at the driving frequency;
 a_{tot} = total grms of the applied acceleration (including the value of a_1).

⁴ The grms of a sinusoid equals 0.707 times peak g. It is not related to grms of a random (g^2/Hz) spectrum; do NOT use this to compare sine criteria (g) to random criteria (g^2/Hz).

4.2.2.3 Frequency measurement.

Ensure the vibration measurement system provides frequency measurements within ± 1.25 percent at the transducer mounting surface (or transducer target mounting surface) over the required frequency range.

4.2.2.4 Cross axis accelerations.

In a single axis vibration test, cross axis vibration acceleration in two axes mutually orthogonal and orthogonal to the drive axis should be less than or equal to the values specified in Table 514.8-II for the cross axis of concern. If measured cross axis vibration accelerations exceed these values, the source of the vibration should be identified and addressed. The following common sources of cross axis vibration should be considered:

- a. **Test fixture resonance.** Prior to test, a test fixture survey should be conducted to ensure that the structural characteristics of the test fixture do not introduce uncontrollable resonances into the test setup. The survey may be experimental or analytical. If problematic resonances are identified, modifications should be made to the test fixture to shift the resonance beyond the frequency range of the test or to dampen the resonance in order to minimize the effect on the test.
- b. **Test article resonance.** Cross axis resonances of the test article may be characteristic of the test article structure and not necessarily a product of test fixture or restraint. As long as the test item is secured in a

MIL-STD-810H
METHOD 514.8

manner consistent with the environment being tested, and the test fixture is not introducing unrealistic resonance, the following options should be considered in limiting the cross axis vibration:

- (1) Response Limit - A limit spectrum may be applied to the cross axis response of the test article in order to effectively notch the control spectrum in the drive axis. This limit spectrum should be defined in terms of the test profile for the cross axis of concern. For example, if the transverse response to vertical axis test is excessive, the transverse response should be limited to some factor of the corresponding transverse profile. In a random vibration test, the cross axis resonances are often narrow frequency bands, the notching may be within acceptable tolerances.
- (2) Multi-axis Test - If the test article structure is such that the cross axis vibration response to a single axis vibration test is beyond acceptable levels, it may be necessary to conduct the test as a multi-axis in order to simultaneously control multiple axes of vibration to the required test profiles. Method 527.1 discusses the technical details associated with multi-axis vibration testing.

4.2.3 Instrumentation.

In general, acceleration will be the quantity measured to meet the vibration specification. On occasion, other devices may be employed, e.g., strain gage, linear displacement/voltage transducer, force gage, laser velocimeter, rate gyro, etc. In these cases, give special consideration to the instrument specification to satisfy the calibration, measurement, and analysis requirements. Calibrate all measurement instrumentation to traceable national calibration standards (see Part One, paragraph 5.3.2). The measurement device and its mounting will be compatible with the requirements and guidelines provided in paragraph 6.1, reference c.

- a. Accelerometer. In the selection of any transducer, one should be familiar with all parameters provided on the associated specification sheet. Key performance parameters for an accelerometer follow:
 - (1) Frequency Response: A flat frequency response within ± 5 percent across the frequency range of interest is required.
 - (2) Transverse sensitivity should be less than or equal to 5 percent.
 - (3) Nearly all transducers are affected by high and low temperatures. Understand and compensate for temperature sensitivity deviation as required. Temperature sensitivity deviations at the test temperature of interest should be no more than ± 5 percent relative to the temperature at which the transducer sensitivity was established.
 - (4) Base Strain sensitivity should be evaluated in the selection of any accelerometer. Establishing limitations on base strain sensitivity is often case specific based upon the ratio of base strain to anticipated translational acceleration.
- b. Other measurement devices. Any other measurement devices used to collect data must be demonstrated to be consistent with the requirements of the test.
- c. Signal conditioning. Use only signal conditioning that is compatible with the instrumentation requirements of the test, and is compatible with the requirements and guidelines provided in paragraph 6.1, reference c. In particular, filtering of the analog voltage signals will be consistent with the time history response requirements (in general, demonstrable linearity of phase throughout the frequency domain of response), and the filtering will be so configured that anomalous acceleration data caused by clipping will not be misinterpreted as response data.

4.3 Test interruption.

Test interruptions can result from multiple situations. The following paragraphs discuss common causes for test interruptions and recommended paths forward for each. Recommend test recording equipment remain active during any test interruption if the excitation equipment is in a powered state.

4.3.1 Interruption due to laboratory equipment malfunction.

- a. General. See Part One, paragraph 5.11, of this Standard.
- b. Specific to this Method. When interruptions are due to failure of the laboratory equipment, analyze the failure to determine root cause. It is also strongly advised that both control and response data be evaluated

MIL-STD-810H
METHOD 514.8

to ensure that no undesired transients were imparted to the test item during the test equipment failure. If the test item was not subjected to an over-test condition as a result of the equipment failure, repair the test equipment or move to alternate test equipment and resume testing from the point of interruption. If the test item was subjected to an over-test condition as a result of the equipment failure, the test engineer or program engineer responsible for the test article should be notified immediately. A risk assessment based on factors such as level and duration of the over-test event, spectral content of the event, cost and availability of test resources, and analysis of test specific issues should be conducted to establish the path forward. See Annex A, paragraph 2.1 for descriptions of common test types and a general discussion of test objectives.

4.3.2 Interruption due to test item operation failure.

Failure of the test item(s) to function as required during operational checks presents a situation with several possible options. Failure of subsystems often has varying degrees of importance in evaluation of the test item. Selection of option a through c below will be test specific.

- a. The preferable option is to replace the test item with a “new” one and restart the entire test.
- b. An alternative is to replace / repair the failed or non-functioning component or assembly with one that functions as intended, and restart the entire test. A risk analysis should be conducted prior to proceeding since this option places an over-test condition on the entire test item except for the replaced component. If the non-functioning component or subsystem is a line replaceable unit (LRU) whose life-cycle is less than that of the system test being conducted, proceed as would be done in the field by substituting the LRU, and continue from the point of interruption.
- c. For many system level tests involving either very expensive or unique test items, it may not be possible to acquire additional hardware for re-test based on a single subsystem failure. For such cases, a risk assessment should be performed by the organization responsible for the system under test to determine if replacement of the failed subsystem and resumption of the test is an acceptable option. If such approval is provided, the failed component should be re-tested at the subcomponent level.

NOTE: When evaluating failure interruption, consider prior testing on the same test item and consequences of such.

4.3.3 Interruption due to a scheduled event.

There are often situations in which scheduled test interruptions will take place. For example, in a tactical transportation scenario, the payload may be re-secured to the transport vehicle periodically (i.e., tie-down straps may be re-secured at the beginning of each day). Endurance testing often represents a lifetime of exposure; therefore it is not realistic to expect the payload to go through the entire test sequence without re-securing the tie-downs as is done in a tactical deployment. Similarly, items mounted on rubber isolation systems may require monitoring of the isolator temperature with planned test interruptions to prevent overheating and unnatural failure of the isolator. Many other such interruptions, to include scheduled maintenance events, are often required over the life-cycle of materiel. Given the cumulative nature of fatigue imparted by dynamic testing, it is acceptable to have test interruptions that are correlated to realistic life-cycle events. All scheduled interruptions should be documented in the test plan and test report.

4.3.4 Interruption due to exceeding test tolerances

Exceeding the test tolerances defined in paragraph 4.2.2, or a noticeable change in dynamic response may result in a manual operator initiated test interruption or an automatic interruption when the tolerances are integrated into the control strategy. In such cases, the test item, fixturing, and instrumentation should be checked to isolate the cause.

- a. If the interruption resulted from a fixturing or instrumentation issue, review the data leading up to the test interruption and assess the extent of over/under test, if any. If an over/under test condition is identified, document the incident and obtain approval from the organization responsible for the system under test to correct the problem and resume the test.

MIL-STD-810H
METHOD 514.8

- b. If the interruption resulted from a structural or mechanical degradation of the test item, the problem will generally result in a test failure and requirement to re-test unless the problem is allowed to be corrected during testing by the organization responsible for the system under test. If the test item does not operate satisfactorily, see paragraph 5 for failure analysis, and follow the guidance in paragraph 4.3.2 for test item failure.

4.4 Test Setup.

See Part One, paragraph 5.8. For standardization purposes, major axes are defined as vertical (perpendicular to level ground); longitudinal (parallel to vehicle fore and aft movement), and transverse (perpendicular to vertical and longitudinal movement).

4.4.1 Procedure I - General vibration.

- a. Test Configuration. Configure the test item appropriately for the life cycle phase to be simulated.
 - i. Transportation. Configure the test item for shipment including protective cases, devices, and/or packing. Mount the test item to the test fixture(s) by means of restraints and/or tie downs dynamically representative of life cycle transportation events.
 - ii. Operational service. Configure the test item for service use. Secure the test item to the test fixture(s) at the mounting point(s) and use the same type of mounting hardware as used during life cycle operational service. Provide all mechanical, electrical, hydraulic, pneumatic or other connections to the materiel that will be used in operational service. Ensure these connections dynamically simulate the service connections and that they are fully functional unless otherwise specified.
- b. Instrumentation. Installation and location of the control accelerometer(s) can significantly affect test outcome. It is recommended to mechanically attach (i.e., screw mount) control accelerometer(s) to the vibration test fixture near the test item interface(s) or at the location(s) used to derive the test specification. Additional control and/or response instrumentation may be attached with screws or adhesives to other locations on the vibration table or test item as specified in the test plan. All instrumentation locations should be described in the test plan and in the specification derivation report. Examples are presented in Annex C.

4.4.2 Procedure II - Loose cargo transportation.

The loose cargo test can be considered as being of two types that differ from one another only in the installation conditions of the materiel. Two different setups of fencing are required depending on the type of test item. The two types are those that are more likely to slide on the test surface or “rectangular cross section items” (typically packaged items), and those most likely to roll on the surface or “circular cross section items.” See paragraph 4.5.3 for details of the test procedure. Fencing information is presented in Annex C, paragraph 2.2. Because part of the damage incurred during testing of these items is due to the items impacting each other, the number of test items should be greater than three where the size of the item is such that more than three items in a typical cargo truck bed. Although the loose cargo transportation simulators are typically operated at fixed rates of rotation, it is recommended to monitor and record an accelerometer on the table surface in order to (1) provide measurable verification of the table motion and (2) detect any change in the test setup caused by degradation of the fencing or damage to the test article.

4.4.3 Procedure III - Large assembly transport.

Install the test item in/on the vehicle in its intended transport or service configuration. If the test assembly is to be contained within a shelter, or if other units are attached to the materiel assembly in its in-service configuration, also install these items in their design configuration.

- a. Test surfaces. When setting up the test, consider the test surfaces available at the particular test location (see paragraph 6.1, reference b). Also, ensure the selection of test surfaces, test distances, and test speeds are appropriate for the specified vehicles and their anticipated use as defined in the vehicle OMS/MP.
- b. Test loads. Response of the vehicle to the test terrain is a function of the total load and the distribution of the load on the vehicle. In general, a harsher ride occurs with a lighter load, while a heavier load will result

MIL-STD-810H
METHOD 514.8

in maximum levels at lower frequencies. Multiple test runs with variations in load may be required to include worst case, average, or other relevant cases.

- c. Tie-down/mounting arrangements. During the test, it is important to reproduce the more adverse arrangements that could arise in normal use. For example, during transportation, relaxation of tie-down strap tension could allow the cargo to lift off the cargo bed and result in repeated shock conditions. Excessive tightening of webbing straps could prevent movement of test items and thereby reduce or eliminate such shocks.

4.4.4 Procedure IV - Assembled aircraft store captive carriage and free flight.

- a. Captive carriage test fixture. Suspend the test item (store) from a structural support frame by means of the operational service store suspension equipment (bomb rack, launcher, pylon, etc.). Ensure the flexible modes of the support frame are as high as practical, at least twice the first flexible frequency of the store, and that they do not coincide with store modes. Include and load (torque, clamp, latch, etc.) sway braces, lugs, hooks or other locking and load carrying devices that attach the store to the suspension equipment and the suspension equipment to the carrier aircraft, as required for captive carriage in service. Ensure the layout of the structural support frame and the test area is such that there is adequate access for the vibration exciters and test materiel.
 - (1) Configure the assembled store for captive carriage and mount it to the structural support frame. Softly suspend the structural support frame within the test chamber. Ensure that rigid body modes of the store, suspension equipment, and structural support frame combination are between 5 and 20 Hz, and lower than one half the lowest flexible mode frequency of the store. Use structural support that is sufficiently heavy and of sufficient pitch and roll inertias to approximately simulate carrier aircraft dynamic reaction mass. If the structural support is too heavy or its inertia too large, the store suspension equipment and store hardback will be over-stressed. This is because unrealistically high dynamic bending moments are needed to match acceleration spectral densities. Conversely, if the structural support is too light or its inertia too low, there will be an undertest of the suspension equipment and store hardback.
 - (2) Do not use the structural support to introduce vibration into the store. Hard-mounting stores to large shakers has proven to be inadequate. Test experience with F-15, F-16, and F/A-18 stores indicates that including a structural support/reaction mass greatly improves the match between flight measured data and laboratory vibrations, particularly at lower frequencies.
 - (3) In cases in which the frequency requirements in (1) and (2) cannot be met, consider force control strategy (see paragraph 4.2.1.2).
- b. Free flight test fixture. Configure the assembled test store for free flight and softly suspend it within the test chamber. Ensure rigid body modes of the suspended store are between 5 and 20 Hz and lower than one half the lowest flexible mode frequency of the store.
- c. Orientation. With the store suspended for test, the longitudinal axis is the axis parallel to the ground plane and passing through the longest dimension of the store. The vertical axis is mutually perpendicular to the ground plane and the longitudinal axis. The transverse axis is mutually perpendicular to longitudinal and vertical axes.
- d. Vibration excitation. Store longitudinal vibration is typically less than vertical and transverse vibration. Vertical and transverse excitation of store modes usually results in sufficient longitudinal vibration. When a store is relatively slender (length greater than 4 times the height or width), drive the store in the vertical and transverse axes. In other cases, drive the store in the vertical, transverse, and longitudinal axes. If a store contains material that is not vibration tested except at assembled store level, or the store contains components that are sensitive to longitudinal vibration, include longitudinal excitation.
 - (1) Transmit vibration to the store by means of rods (stingers) or other suitable devices running from vibration exciters to the store. Separate drive points at each end of the store in each axis are recommended. Ideally, the store will be driven simultaneously at each end. However, it can be driven at each end separately. A single driving point in each axis aligned with the store aerodynamic center

MIL-STD-810H
METHOD 514.8

has also been successful. Use drive points on the store surfaces that are relatively hard and structurally supported by the store internal structure or by test fixture(s) (usually external rings around the local store diameter) that distribute the vibratory loads into the store primary structure.

- (2) There are many signal forms available to drive the vibration exciters. Some of the most popular are uncorrelated random, sinusoidal and transient (burst random or sine) excitation. Consideration of the characteristics of the store structure, the suspension equipment, general measurement considerations, and the desired data resolution will dictate selection of the driving signals. Uncorrelated random excitation and burst random excitation should be accomplished such that the signals are driven periodically within each data acquisition block in order to improve the data quality of the derived frequency response functions (FRFs). Use of more than one vibration exciter with random excitation will assist in minimizing the influence of non-linear behavior and allows the structure to be uniformly excited and allow for better FRFs. In turn, sinusoidal excitation should be used to characterize non-linearities in the system. For suspension systems involving carriage of multiple stores, the relative phase characteristics between stores should be defined and efforts made to replicate relative phasing in the laboratory setting to the maximum degree possible. It is acknowledged that there may not be sufficient excitation degrees-of-freedom to have full control authority over the phase characteristics of multiple stores. When more than one vibration exciter is used simultaneously, knowledge of multiple exciter testing techniques that include specification of the vibration exciter cross-spectral density matrices is required (reference Method 527.1). The auto and cross-spectral density characteristics should be made available as part of the test specification. In the absence of measured cross-spectral data, the cross-spectrum will need to be either estimated via model, or assumed to be uncorrelated. Additional information regarding specification of cross-spectral parameters is addressed in paragraph 6.1, reference gg. For the case in which the cross-spectral density between drive points is assumed to be zero, recognize that due to coupling between the vibration exciters via the store/suspension structure, some level of correlation between the control points will generally exist.
- e. **Instrumentation.** Mount transducers on the store and/or the store excitation devices to monitor compliance of vibration levels with requirements, to provide feedback signals to control the vibration exciter, and to measure materiel function. Additionally, it is usually important to overall program objectives to add transducers to measure the local vibration environment throughout the store. Note the vibration exciter control strategy used, e.g., single point response, multipoint response, force limit, waveform, etc. Also note the relationship between field measurement data and laboratory measurement data.
- (1) Mount accelerometers to monitor vibration levels at the forward and aft extremes of the primary load carrying structure of the store. Do not mount these accelerometers on fairings, unsupported areas of skin panels, aerodynamic surfaces, or other relatively soft structures. In some cases (see paragraph 4.4.4c above), transducers are required in the vertical and transverse directions. In other cases, transducers are required in vertical, transverse, and longitudinal directions. Designate these transducers as the test monitor transducers.
 - (2) An alternate method is to monitor the test with strain gages that are calibrated to provide dynamic bending moment. This has proven successful where integrity of the store primary structure is a major concern. Flight measured dynamic bending moment data is required for this Method. Also, use accelerometers positioned as discussed above to verify that general vibration levels are as required.
 - (3) As feedback control transducers, use either accelerometers on or near the store/vibration transmission device(s)/vibration exciter interface, force transducer(s) in series with the store/vibration transmission device(s)/vibration exciter, or dynamic bending moment strain gages. A clear understanding of the vibration exciter control strategy and its effects on the overall measurements is necessary.

4.5 Test Execution.

The following steps, alone or in combination, provide the basis for collecting necessary information concerning the durability and function of a test item in a vibration environment.

MIL-STD-810H
METHOD 514.8**4.5.1 Preparation for test.****4.5.1.1 Preliminary steps.**

Before starting a test, review pretest information in the test plan to determine test details (procedure(s), test item configuration(s), levels, durations, vibration exciter control strategy, failure criteria, item operational requirements, instrumentation requirements, facility capability, fixture(s), etc.).

- a. Select appropriate vibration exciters and fixtures.
- b. Select appropriate data acquisition system (e.g., instrumentation, cables, signal conditioning, recording, analysis equipment).
- c. Operate vibration equipment without the test item installed to confirm proper operation.
- d. Ensure the data acquisition system functions as required.

4.5.1.2 Pretest standard ambient checkout.

All items require a pretest standard ambient checkout to provide baseline data. Conduct the pretest checkout as follows:

- Step 1. Examine the test item for physical defects, etc. and document the results.
- Step 2. Prepare the test item for test, in its operating configuration if required, as specified in the test plan.
- Step 3. Examine the test item/fixture/exciter combination for compliance with test item and test plan requirements.
- Step 4. If applicable, conduct an operational checkout in accordance with the test plan and document the results for comparison with data taken during or after the test. If the test item does not operate as required, resolve the problems and repeat this step.

4.5.2 Procedure I - General vibration.

- Step 1. Conduct a fixture modal survey or resonance search, if required, and verify that fixture design is compliant with recommended practices, and meets any test defined requirements that may have been provided in the item-specific test plan (see paragraph 6.1, references aa, dd, and ee).
- Step 2. Mount the test item to the test fixture in a manner dynamically representative of the life cycle event simulated.
- Step 3. Install sufficient transducers on or near the test item/fixture/vibration exciter combination to measure vibration at the test item/fixture interface, to control the vibration exciter as required by the control strategy, and measure any other required parameters. Mount control transducer(s) as close as possible to the test item/fixture interface. Ensure that the total accuracy of the instrumentation system is sufficient to verify that vibration levels are within the tolerances of paragraph 4.2.2, and to meet additionally specified accuracy requirements.
- Step 4. Conduct a test item modal survey or resonance search, if required.
- Step 5. Perform a visual inspection of the test setup.
- Step 6. Apply low level vibration to the test item/fixture interface. If required, include other environmental stresses.
- Step 7. Verify that the vibration exciter, fixture, and instrumentation system function as required.
- Step 8. Apply the required vibration levels to the test item/fixture interface. Apply additional environmental stresses as required.
- Step 9. Monitor vibration levels and, if applicable, test item performance continuously through the exposure. If levels shift or a failure occurs, shut down the test in accordance with the test interruption procedure (paragraph 4.3.2). Determine the reason for the shift and proceed in accordance with the test interruption recovery procedure (paragraph 4.3.2).

MIL-STD-810H
METHOD 514.8

- Step 10. When the required duration has been achieved, stop the vibration.
- Step 11. If the test plan calls for additional exposures, repeat Steps 5 through 10 as required by the test plan before proceeding.
- Step 12. Inspect the test item, fixture, vibration exciter, and instrumentation. If failure, wear, looseness, or other anomalies are found, proceed in accordance with the test interruption recovery procedure (paragraph 4.3.2).
- Step 13. Verify that the instrumentation functions as required, and perform an operational check of the test item as required per the test plan. If the test item fails to operate as intended, follow the guidance in paragraph 4.3.2 for test item failure.
- Step 14. Repeat Steps 1 through 13 for each required excitation axis.
- Step 15. Remove the test item from the fixture and inspect the test item, mounting hardware, packaging, etc., for any signs of visual mechanical degradation that may have occurred during testing. See paragraph 5 for analysis of results.

4.5.3 Procedure II - Loose cargo transportation

- Step 1. Place the test item(s) on the package tester within the restraining fences in accordance with paragraph 2.2 of Annex C.
- Step 2. Install instrumentation to measure the rotational speed of the package tester. Ensure the total accuracy of the instrumentation system is sufficient to meet specified accuracy requirements.
- Step 3. After determining the number of possible test item orientations and corresponding test time (paragraph 3.1d), operate the package tester for the prescribed orientation duration (Annex C, paragraph 2.2).
- Step 4. Perform a visual inspection of the test item and an operational check. If the test item fails to operate as intended, follow the guidance in paragraph 4.3.2 for test item failure. Otherwise, proceed to Step 5.
- Step 5. Reorient the test item(s) and/or the fencing/impact walls in accordance with paragraph 3.1d(1) and Annex C, paragraph 2.2b.
- Step 6. Operate the package tester for the next prescribed duration.
- Step 7. Perform a visual inspection of the test item and an operational check. If the test item fails to operate as intended, see paragraph 5 for analysis of results, and follow the guidance in paragraph 4.3.2 for test item failure.
- Step 8. Repeat Steps 5-7 for the total number of orientations.
- Step 9. Perform a final visual inspection of the test item and an operational check. See paragraph 5 for analysis of results.

4.5.4 Procedure III - Large assembly transport.

- Step 1. Mount the test item(s) on/in the test vehicle as required in the test plan.
- Step 2. If required, install transducers on or near the test item sufficient to measure vibration at the test item/vehicle interface, and to measure any other required parameters. Protect transducers to prevent contact with surfaces other than the mounting surface.
- Step 3. Subject the vehicle containing the test item to the specified test conditions in Annex C, paragraph 2.3, or as otherwise specified in the test plan.
- Step 4. Perform a visual inspection of the test item and an operational check. If the test item fails to operate as intended, follow the guidance in paragraph 4.3.2 for test item failure.
- Step 5. Repeat Steps 1 through 4 for additional test runs, test loads, or test vehicles as required by the test plan.

MIL-STD-810H
METHOD 514.8

Step 6. Perform a final visual inspection of the test item and an operational check. See paragraph 5 for analysis of results.

4.5.5 Procedure IV - Assembled aircraft store captive carriage and free flight.

Step 1. With the store suspended within the test chamber and the instrumentation functional, verify that the store suspension system functions as required by measuring the suspension frequencies.

Step 2. If required, conduct a test item modal survey.

Step 3. If required, place the test item in an operational mode and verify that it functions properly. Perform a visual inspection of the test setup.

Step 4. Apply low level vibration to the vibration exciter/store interface(s) to ensure the vibration exciter and instrumentation system function properly. For acceleration feedback control, use an initial input level 12 dB down from the required forward test monitor transducer spectrum. For force feedback control, use a flat force spectrum where the response at the test monitor accelerometer is at least 12 dB below the required test monitor value at all frequencies. For bending moment feedback control, use an initial input level that is 12 dB down from the required test monitor transducer spectrum.

Step 5. Adjust the vibration exciter(s) such that the test monitor transducers in the excitation axis meet the test requirements. For acceleration control, identify the test monitor transducer spectrum peaks that exceed the input spectrum by 6 dB or more (frequencies may differ fore and aft). For force feedback control, identify major peaks from the force measurements to check monitor accelerometer transfer functions. For both cases, equalize the input spectra until the identified peaks equal or exceed the required test levels. The identified peaks shall include at least the first 3 structural elastic modes of the store airframe, any local mode frequencies for subsystem structure of significant mass, and any frequencies which correspond with subassembly local modes which are critical for store performance. Additionally, the input spectra should be equalized at all frequencies up to the first flexible bending mode peak of the store to achieve the required test levels for ensuring the aircraft suspension equipment / store interface is adequately stressed. The resulting input spectra should be as smooth and continuous as possible while achieving the required peak responses. (It is not necessary to fill in valleys in the test monitor transducer spectra; however, it is not acceptable to notch out the input in these valleys.) For bending moment control raise and shape the input spectrum until it matches the required spectrum (peaks and valleys).

Step 6. When the input vibration is adjusted such that the required input response (R_1) is achieved, measure the off-axis response(s) (R_2, R_3). Verify that off-axis response levels are within requirements using the following equations. If the result obtained from the equation is greater than the value established for the equation, reduce the input vibration level until the achieved input and off-axis response levels are less than or equal to the appropriate constant. Apply these equations at each peak separately. Use the first equation for testing that requires vibration application in two separate mutually perpendicular axes, and use the second equation for testing that requires vibration application in three separate mutually perpendicular axes. Refer to paragraph 4.2.2.4 for additional guidance.

$$\begin{aligned} (R_1/A_1 + R_2/A_2) &\leq 2 \\ \text{or} \\ (R_1/A_1 + R_2/A_2 + R_3/A_3) &\leq 3 \end{aligned}$$

Where

R_i = Response level in g^2/Hz or $(N-m)^2/Hz$ or $(in-lb)^2/Hz$ for $i = 1 - 3$, and

A_i = Test requirement level in g^2/Hz or $(N-m)^2/Hz$ or $(in-lb)^2/Hz$ for $i = 1 - 3$

For example:

For testing that requires vibration application in three, separate, mutually-perpendicular axes, and the vibration is being applied in the vertical axis, use the equation below as follows:

$$(R_1/A_1 + R_2/A_2 + R_3/A_3) \leq 3$$

MIL-STD-810H
METHOD 514.8

Where:

R_1 = Vertical axis response level
 A_1 = Vertical axis requirement level
 R_2 = Transverse axis response level
 A_2 = Transverse axis requirement level
 R_3 = Longitudinal axis response level
 A_3 = Longitudinal axis requirement level.

For vibration being applied in either the transverse or longitudinal axis, repeat the above process.

$$(R_1/A_1 + R_2/A_2 + R_3/A_3) \leq 3$$

- Step 7. Verify that vibration levels are as specified. If the exposure duration is 1/2 hour or less, accomplish this step immediately after full levels are first applied, and immediately before scheduled shut down. Otherwise, accomplish this step immediately after full levels are first applied, every half-hour thereafter, and immediately before scheduled shut down.
- Step 8. Monitor the vibration levels and test item performance continuously through the exposure. If levels shift, performance deviates beyond allowable limits, or failure occurs, shut down the test in accordance with the test shut down procedure (paragraph 4.3). Determine the reason for the anomaly and proceed in accordance with the test interruption recovery procedure (paragraph 4.3).
- Step 9. When the required duration has been achieved, stop the vibration.
- Step 10. If the test plan calls for additional exposures, repeat Steps 3 through 9 as required by the test plan before proceeding.
- Step 11. Inspect the test item, fixture, vibration exciter, and instrumentation. If failure, wear, looseness or other anomalies are found, proceed in accordance with the test interruption recovery procedure (paragraph 4.3).
- Step 12. Verify that the instrumentation functions as required and perform an operational check of the test item for comparison with data collected in paragraph 4.5.1.2. If the test item fails to operate as intended, follow the guidance in paragraph 4.3.2 for test item failure.
- Step 13. Repeat Steps 1 through 12 for each required excitation axis.
- Step 14. Remove the test item from the fixture and inspect the test item, mounting hardware, packaging, etc., for any signs of visual mechanical degradation that may have occurred during testing. See paragraph 5 for analysis of results.

5. ANALYSIS OF RESULTS.

In addition to the guidance provided in Part One, paragraph 5.14, the following is provided to assist in the evaluation of the test results.

5.1 Physics of Failure.

Analyses of vibration related failures must relate the failure mechanism to the dynamics of the failed item and to the dynamic environment. It is insufficient to determine that something broke due to high cycle fatigue or wear. It is necessary to relate the failure to the dynamic response of the materiel to the dynamic environment. Thus, include in failure analyses a determination of resonant mode shapes, frequencies, damping values and dynamic strain distributions, in addition to the usual material properties, crack initiation locations, etc. (See paragraph 6.1, references ll and mm, and Annex A, paragraph 2.5.)

5.2 Qualification Tests.

When a test is intended to show formal compliance with contract requirements, recommend the following definitions:

MIL-STD-810H
METHOD 514.8

- a. **Failure definition.** “Materiel is deemed to have failed if it suffers permanent deformation or fracture; if any fixed part or assembly loosens; if any moving or movable part of an assembly becomes free or sluggish in operation; if any movable part or control shifts in setting, position or adjustment, and if test item performance does not meet specification requirements while exposed to functional levels and following endurance tests.” Ensure this statement is accompanied by references to appropriate specifications, drawings, and inspection methods.
- b. **Test completion.** “A vibration qualification test is complete when all elements of the test item have successfully passed a complete test. When a failure occurs, stop the test, analyze the failure, and either repair the test item or replace with a modified test item. Continue or repeat the test until all fixes have been exposed to a complete test. Each individual element is considered qualified when it has successfully passed a complete test (see paragraph 4.3). Qualified elements that fail during extended tests are not considered failures, and can be repaired to allow test completion.”

5.3 Other Tests.

For tests other than qualification tests, prepare success and/or failure criteria and test completion criteria that reflect the purpose of the tests.

6. REFERENCE/RELATED DOCUMENTS

6.1 Referenced Documents.

- a. Methodology Investigation, Final Report of the TECOM Package Tester Characterization, DTIC AD No. B217688, September 1996.
- b. Test Operations Procedure (TOP) 01-1-011A, Vehicle Test Facilities at Aberdeen Test Center Yuma Test Center, 27 February 2012; DTIC AD No. ADA557002. "Vehicle Test Facilities at Aberdeen Test Center and Yuma Test Center"
- c. Handbook for Dynamic Data Acquisition and Analysis, IEST-RD-DTE012.2; Institute of Environmental Sciences and Technology, Arlington Place One, 2340 S. Arlington Heights Road, Suite 100, Arlington Heights, IL 60005-4516; Institute of Environmental Sciences and Technology Website.
- d. Test Operations Procedure (TOP) 01-2-601, Ground Vehicle Laboratory Vibration Schedules. 18 May 2015.
- e. International Test Operating Procedure (ITOP) 1-1-050. Development of Laboratory Vibration Test Schedules. 6 June 1997. DTIC AD No B227368.
- f. Tevelow, Frank L., The Military Logistical Transportation Vibration Environment: Its Characterization and Relevance to MIL-STD Fuse Vibration Testing. Harry Diamond Laboratories, December 83. HDL-SR-83-11.
- g. Connon, William H. (III). Methodology Investigation, Final Report, Ground Vehicle - Loose Cargo Vibration Schedules. January 1987. DTIC AD No. B1114819L.
- h. White, George O., Methodology Investigation, Final Report, Loose Cargo Testing of Unpackaged Separate Loading Projectiles. May 1990, DTIC AD No. B144437.
- i. Wafford, J.H. and J. F. Dreher, Aircraft Equipment Vibration Test Criteria Based on Vibration Induced by Jet and Fan Engine Exhaust Noise. Shock and Vibration Bulletin 43, Part 3, 1973, pp. 141-151. Shock & Vibration Information Analysis Center (SAVIAC), PO Box 165, 1104 Arvon Road, Arvon, VA 23004.
- j. Dreher, J. F., Aircraft Equipment Random Vibration Test Criteria Based on Vibration Induced by Turbulent Air Flow Across Aircraft External Surfaces. Shock and Vibration Bulletin 43, Part 3, 1973, pp. 127-139. Shock & Vibration Exchange (SAVE), 1104 Arvon Road, Arvon, VA 23004.
- k. Hinegardner, W. D., et al., Vibration and Acoustics Measurements on the RF-4C Aircraft. Wright-Patterson AFB, OH: ASD Systems Engineering Group, 1967, TM-SEF-67-4.

MIL-STD-810H
METHOD 514.8

- l. Bartel, H. W and J. M. McAvoy, Cavity Oscillation in Cruise Missile Carrier Aircraft. Air Force Wright Aeronautical Laboratories, June 1981. AFWAL-TR-81-3036; DTIC No. ADA108610.
- m. Tipton, A. G., Weapon Bay Cavity Noise Environments Data Correlation and Prediction for the B-1 Aircraft. Air Force Wright Aeronautical Laboratories, June 1980. AFWAL-TR-80-3050.
- n. Thomas, C. E., Flight Survey of C-130A Aircraft. March 1962. ASD-TR-62-2167. DTIC No. AD-274-904.
- o. Bolds, P. G., Flight Vibration Survey C-133 Aircraft. April 1962. ASD-TDR-62-383. DTIC No. AD-277-128.
- p. Kuhn, D. L., Analysis of the Vibration Environment for Airborne Reconnaissance Integrated Electronics System (ARIES) Installed on EP-3E Aircraft. Indianapolis: Naval Avionics Center 443, 1975. Document No. ESL-163.
- q. Kuhn, D. L. and R. M. Johnson., Evaluation of the Vibration Environment for the Doppler Ranging Information System. Indianapolis: Naval Avionics Center 443, 1982. Document No. ESL-420.
- r. Analysis of the Vibration Environment for TACAMO IV B System Installed on ED-130 Aircraft. Indianapolis: Naval Avionics Center 443, 1976. Document No. ESL-199.
- s. Kuhn, D. L., Evaluation of Flight Data for the Big Look Antenna System OE-319/APS Installed on EP-3E aircraft. Indianapolis: Naval Avionics Center 443, 1981. Document No. ESL-418.
- t. Kuhn, D. L., Analysis of Flight Data for Deepwell System Installed in EP-3E Aircraft. Indianapolis: Naval Avionics Center 443, 1975. Document No. ESL-169.
- u. Dreher, J. F., E. D. Lakin, and E. A. Tolle, Vibroacoustic Environment and Test Criteria for Aircraft Stores During Captive Flight. Shock and Vibration Bulletin 39, Supplement (1969), pp. 15-40. Shock & Vibration Exchange (SAVE), 1104 Arvon Road, Arvon, VA 23004.
- v. Dreher, J. F., Effects of Vibration and Acoustical Noise on Aircraft/Stores Compatibility. Aircraft Store Symposium Proceedings, Vol. 6, November 1969.
- w. Piersol, A. G., Vibration and Acoustic Test Criteria for Captive Flight of Externally Carried Stores, December 1971. AFFDL-TR-71-158. DTIC No. AD-893-005L.
- x. Frost, W. G., P. B. Tucker, and G. R. Waymon, Captive Carriage Vibration of Air-to-Air Missiles on Fighter Aircraft. Journal of Environmental Sciences, 21:15, (September/October 1978), pp. 11-15. Institute of Environmental Sciences and Technology, Arlington Place One, 2340 S. Arlington Heights Road, Suite 100, Arlington Heights, IL 60005-4516.
- y. Mechanical Vibrations; Den Hartog, J. P., Fourth Edition, McGraw-Hill Book Company. 1956.
- z. A Modern Course in Aeroelasticity. Dowell, E. H., et al, Second Edition, Kluwer Academic Publisher, 1989.
- aa. Shock and Vibration Handbook, Fifth Edition, Edited by Harris, Cyril M. and Piersol, Allan G.; McGraw-Hill Book Company.
- bb. Bendat, Julius S., and Piersol, Allan G., Engineering Applications of Correlation and Spectral Analysis, 2nd Edition, John Wiley & Sons, Inc., New York, 1993. Wiley Interscience, ISBN 0471570554, 1993.
- cc. Allemang, Randall J. and David L. Brown, Experimental Modal Analysis and Dynamic Component Synthesis - Measurement Techniques for Experimental Modal Analysis. Vol. 2. December 1987. AFWAL-TR-87-3069, DTIC No. ADA195145.
- dd. Allemang, Randall J. and David L. Brown, Experimental Modal Analysis and Dynamic Component Synthesis - Modal Parameter Estimation. Vol. 3. December 1987. AFWAL-TR-87-3069, DTIC No. ADA195146.

MIL-STD-810H
METHOD 514.8

- ee. Allemang, Randall J. and David L. Brown, Experimental Modal Analysis and Dynamic Component Synthesis - System Modeling Techniques. Vol. 6. December 1987. AFWAL-TR-87-3069, DTIC No. ADA195148.
- ff. Airplane Aerodynamics, Dommasch, Daniel O, Sidney S. Sherby and Thomas F. Connolly, Pitman Publishing Corporation, 1958.
- gg. Smallwood, David, Multiple Input Multiple Output (MIMO) Linear Systems Extreme Inputs/Outputs. Shock and Vibration 13 (2006) 1-25, Manuscript number SAV-05-058; IOS Press, Inc., 4502 Rachael Manor Drive, Fairfax, VA 22032
- hh. NATO STANAG 4370, Environmental Testing.
- ii. NATO Allied Environmental Conditions and Test Publication (AECTP) 400, Mechanical Environmental Testing, Method 401.
- jj. NATO Allied Environmental Conditions and Test Publication (AECTP) 240, Mechanical Environmental Testing.
- kk. U.S. Standard Atmosphere, 1976; DTIC No. ADA035728.
- ll. NATO STANAG 4570, Evaluating the Ability of Materiel to Meet Extended Life Requirements; 2004; Information Handling Services.
- mm. NATO Allied Environmental Conditions and Test Publication (AECTP) 600, A Ten Step Method for Evaluating the Ability of Materiel to Meet Extended Life Requirements; December 2004; Leaflet 604; Information Handling Services.
- nn. Ehlers, E.L., and Cline, H.T., "Methodology Investigation Final Report Improvement of Shock and Vibration Testing - Schedules for Transport of Loose, Restrained and Restrained Cargo," Report No. APG-MT-5521, September 1981, ADB060211.
- oo. Foley, J.T., M. B. Gens, C. G. Magnuson, and R. A. Harley; "Transportation Dynamic Environment Summary," Sandia Laboratories, EDB 1354, January 1973b.
- pp. Barry, M., "Test Record, Composite Wheeled Vehicle Vibration Schedule Development," USAADSS No. 2005-DT-ATC-SNIMT-D0079, US Army Aberdeen Test Center, Report No. 06-AID-115, October 2006.
- qq. The Shock and Vibration Monograph Series, SVM-8, "Selection and Performance of Vibration Tests," 1971; Shock & Vibration Exchange (SAVE), 1104 Arvon Road, Arvon, VA 23004.
- rr. Robinson, J.A., Final Report, Methodology Investigation "Cargo Configuration and Restraint in Military Ground Vehicles," TECOM-Project No. 7-CO-RD8-AP1-002; US Army Aberdeen Proving Ground, Report No. APG-MT-5319, November 1979.
- ss. Ehlers, E.L. and Cline, H.T., Final Report, Methodology Investigation, "Realistic Vehicle Mileages for Installed Equipment in Ground Vehicles," TECOM Project No. T-CO-RD2-AP1-003; US Army Aberdeen Proving Ground, Report No. APG-MT-5804, December 1983.
- tt. Baily, R.D., Corr, J.R., Final Report, Methodology Investigation, "Realistic Test Schedules for Restrained Cargo in Military Vehicles, Groups I and II," TECOM Project No. T-CO-RD3-AP1-002; US Army Aberdeen Proving Ground, Report No. APG-MT-5948, January 1984.
- uu. US TOP 2-2-506A, "Wheeled and Tracked Vehicle Endurance Testing", 2 October 2014, ADA610880.
- vv. Baily, R.D., Final Report, Methodology Investigation, "Realistic Vibration Schedules for Equipment Installed in Military Vehicles," TECOM Project No. 7-CO-R86-APO-003, US Army Aberdeen Proving Ground. Report No. USACSTA 6656, March 1988.
- ww. Kim, Steven S., "How to Use MIL-STD-810 Helicopter Vibration Test Procedures," Report Number IHTR 2011, Indian Head Division, Naval Surface Warfare Center, 18 August 1997.

MIL-STD-810H
METHOD 514.8

- xx. Test Operations Procedure (TOP) 01-2-603, Rotorcraft Laboratory Vibration Test Schedules, 12 June 2017; DTIC AD No. AD1035102.
- yy. SST-EAS-0581 Issue 1, Assessment Report, Mmunition Vibration and Shock Environments Experienced During Transportation by Hercules C130J Mk 5, June 2005
- zz. ESG-TN-0397 Issue 6, Technical Note, Derivation of Vibration test Severities for the Transport of Material in C130K and C130J Aircraft, 26 May 2005

6.2 Related Documents.

- a. Dynamic Environmental Criteria, NASA Technical Handbook, NASA-HDBK-7005, 2001.
- b. Force Limited Vibration Testing, NASA Technical Handbook, NASA-HDBK-7004, 2003.
- c. Egbert, Herbert W. "The History and Rationale of MIL-STD-810 (Edition 2)," January 2010; Institute of Environmental Sciences and Technology, Arlington Place One, 2340 S. Arlington Heights Road, Suite 100, Arlington Heights, IL 60005-4516.
- d. The Shock and Vibration Monograph Series, SVM 9, "Equivalence Techniques for Vibration Testing," 1972. Shock & Vibration Exchange (SAVE), 1104 Arvon Road, Arvon, VA 23004.
- e. McConnell, Kenneth, Vibration Testing: Theory and Practice, Wiley Interscience, ISBN 0471304352, 1995.
- f. Nelson, Wayne, Accelerated Testing Statistical Models, Test Plans, and Data Analyses, Wiley Interscience, ISBN 0471522775, 1990.
- g. Ewins, D. J., Modal Testing, Theory, Practice and Application, Research Study Press LTD., ISBN 0863802184, 2000.
- h. Bendat, Julius S., Piersol, Allan, G., Random Data Analysis and Measurement Procedures, Wiley Interscience, ISBN 0471317730, 3d edition, 2000.
- i. Lalanne, Christian, Specification Development (Mechanical Vibration and Shock), CRC, ISBN 1560329904, 2002.
- j. Dodson, Bryan and Schwab, Harry, Accelerated Testing: A Practitioner's Guide to Accelerated And Reliability Testing, SAE International, ISBN 0768006902, 2006.
- k. Porter, Alex, Accelerated Testing and Validation, Amsterdam; Newnes, ISBN 0750676531, 2004.
- l. MIL-STD-167-1A, Mechanical Vibrations of Shipboard Equipment (Type I – Environmental and Type II – Internally Excited).
- m. Tustin, Wayne, Random Vibration & Shock Testing, Measurement, Analysis & Calibration, Equipment Reliability Institute, ISBN: 0-9741466-0-9, 2005.

(Copies of Department of Defense Specifications, Standards, and Handbooks, and International Standardization Agreements are available online at <https://assist.dla.mil>.)

Requests for other defense-related technical publications may be directed to the Defense Technical Information Center (DTIC), ATTN: DTIC-BR, Suite 0944, 8725 John J. Kingman Road, Fort Belvoir VA 22060-6218, 1-800-225-3842 (Assistance--selection 3, option 2), <http://www.dtic.mil/dtic/>; and the National Technical Information Service (NTIS), Springfield VA 22161, 1-800-553-NTIS (6847), <http://www.ntis.gov/>.

MIL-STD-810H
METHOD 514.8 ANNEX A**METHOD 514.8, ANNEX A**
Engineering Information

NOTE: Unless specifically noted, all document references refer to paragraph 6.1 in the front part of this Method.

1. SCOPE.**1.1 Purpose.**

This Annex provides information intended to be useful in interpreting Method 514.8.

1.2 Application.

The following discussions concern basic engineering information. They are intended as a quick introduction to the subject matter and are offered without detailed explanations, mathematics, or references. If further information or understanding is required, the technical literature and engineering textbooks should be consulted. Paragraph 6.1, reference aa, is recommended as a starting point.

1.3 Limitations.

See paragraph 1.3 in the front part of this Method.

2. ENGINEERING INFORMATION.**2.1 Vibration Test Types.**

The following presents discussions of general types of vibration tests. Other test types, definitions, and names will be found in practice. All of these test types may not be applied to a given materiel item. A typical materiel development might include development testing and durability testing, while another might include qualification and reliability testing. Environmental worthiness testing is included when needed. Environmental Stress Screening (ESS) is a part of most current DOD acquisitions. All of the tests, including ESS, consume vibratory fatigue life. In many cases, a qualification test, a durability test, or a reliability test consumes so much of the fatigue life of the test article that it is not suitable for field deployment. However, there are instances in which the same tests are conducted to only a portion of the fatigue life in the conduct of a system level version of an ESS test. Similarly, development tests and worthiness tests may or may not consume a complete life depending on the specific test goals. It is important to ensure ESS consumes only an appropriate, hopefully negligible, portion of total life, and that this portion is accounted for in the total life cycle of vibration exposures. In all cases, it is vital to tailor test methodology and requirements to achieve the desired results.

2.1.1 Development test.

Development testing is used to determine characteristics of materiel, to uncover design and construction deficiencies, and to evaluate corrective actions. Begin as early as practical in the development, and continue as the design matures. The ultimate purpose is to assure developed materiel is compatible with the environmental life cycle, and that formal testing does not result in failure. The tests have a variety of specific objectives. Therefore, allow considerable freedom in selecting test vibration levels, excitation, frequency ranges, and durations. Typical programs might include modal analysis to verify analytical mode shapes and frequencies, and sine dwell, swept sine, transient, or random vibration to evaluate function, fatigue life, or wear life. The test types, levels, and frequencies are selected to accomplish specific test objectives. Levels may be lower than life cycle environments to avoid damage to a prototype, higher to verify structural integrity, or raised in steps to evaluate performance variations and fragility.

2.1.2 Qualification test.

Qualification testing is conducted to determine compliance of a materiel with specific environmental requirements. Such tests are commonly a contractual requirement and will include specific test specifications. Qualification tests should be conducted using an excitation that has the same basic characteristics as the anticipated service environment. For most items, this consists of a functional test and an endurance test (sometimes combined). The functional test represents the worst case vibration (or envelope of worst case conditions) of the operational phases of the environmental life cycle. The endurance test is a fatigue test representing an entire life cycle. When separate functional and endurance tests are required, split the functional test duration, with one half accomplished before the endurance test, and one half after the endurance test (in each axis). The duration of each half should be sufficient to

MIL-STD-810H
METHOD 514.8 ANNEX A

fully verify materiel function. This arrangement has proven to be a good way of adequately verifying that materiel survives endurance testing in all respects.

2.1.2.1 Functional test.

Functional testing is conducted to verify that the materiel functions as required while exposed to no less than the worst case operational vibration for a particular segment(s) of a mission profile. Functional vibration levels typically do not include time compression but may include some level of conservatism. Tailor the vibration level for each segment of the mission profile based on measured data, when available, or derived from the operational state of the vehicle platform. This is the maximum vibration environment where the unit under test is expected to function. Fully verify function at the beginning, middle and end of each test segment. Monitor basic function at all times during each test run. In some cases, materiel that must survive severe worst case environments may not be required to function or function at specification levels during worst case conditions. Typically "operating" and "non-operating" envelopes are established. Tailor functional tests to accommodate non-operating portions by modifying functional monitoring requirements as appropriate.

2.1.2.2 Endurance test.

Endurance testing is conducted to reveal time-dependent failures. In many cases the test is accelerated in order to produce the same damage as the entire duration of the required service life. Generally, it is not required to have an item powered-up during the endurance phase of test. Refer to paragraph 2.1.2.1 for functional testing. Use the simplified fatigue relationship in paragraph 2.2 below to scale the less severe vibration levels to the maximum service levels that occur during the service life. This, in turn, will define the test time at maximum service levels (functional levels) that are equivalent to a vibration lifetime (levels vary throughout each mission). Use the equivalent time as the functional test duration, thereby combining functional and endurance tests. There may be cases when this test duration is too long to be compatible with program restraints. In these cases, use as long of a test duration as is practical and use the fatigue relationship to define the test level. While this approach does not completely eliminate nonlinearity questions, it does limit levels to more realistic maximums. Generally, the test item will not be in a powered-up state during the endurance ("non-operating") phase of testing; particularly in a situation in which the test levels have been exaggerated beyond maximum measured values in order to significantly compress the test duration.

2.1.3 Durability test.

Durability testing is a real-time (non-exaggerated) simulation of the environmental life cycle to a high degree of accuracy. A durability analysis precedes the test and is used to determine which environmental factors (vibration, temperature, altitude, humidity, etc.) must be included in the test to achieve realistic results. Although the test is intended to be a real time simulation of the life cycle, it may be shortened by truncation if feasible. Truncation is the elimination of time segments that are shown by the durability analysis to be benign with regard to materiel function and life. Durability analyses should use fatigue and fracture data applicable to each material, rather than the simplified expressions of paragraph 2.2 below.

- a. Worst case levels. Mission portions of the environmental life cycle are represented in the durability test by mission profiles. Mission profiles are statistical definitions of environmental stress and materiel duty cycle versus time. Mission profiles often do not include worst case environmental stresses because they are encountered too rarely to be significant statistically. However, it is important to verify that materiel will survive and function as needed during extreme conditions. Therefore, insert maximum environmental levels into the durability test, in a realistic manner. For example, in the case of a fighter airplane, the maximum levels would be inserted during an appropriate combat mission segment rather than a more benign segment such as cruise.
- b. Success criteria. Pass/fail criteria for durability tests are established for the particular effort. Criteria could include no failures, a maximum number of failures, a maximum amount of maintenance to fix failures, or some combination of these.

2.1.4 Reliability test.

Reliability testing is accomplished to obtain statistical definitions of materiel failure rates. These tests may be development tests or qualification tests. The accuracy of the resulting data is improved by improving realism of the environmental simulation. Test requirements are developed by engineers responsible for materiel reliability. Specific definitions for reliability test as discussed in paragraph 6.1, reference aa, are provided below.

MIL-STD-810H
METHOD 514.8 ANNEX A**2.1.4.1 Statistical Reliability test.**

A statistical reliability test is a test performed on a large sample of production items for a long duration to establish or verify an assigned reliability objective for the equipment operating in its anticipated service environment, where the reliability objective is usually stated in terms of a mean-time-to-failure (MTTF), or if all failures are assumed to be statistically independent, a mean-time-between-failures (MTBF) or failure rate (the reciprocal of MTBF). To provide an accurate indication of reliability, such tests must simulate the equipment shock and vibration environments with great accuracy. In some cases, rather than applying stationary vibration at the measured or predicted maximum levels of the environment, even the non-stationary characteristics of the vibration are reproduced, often in combination with shocks and other environments anticipated during the service life (see Annex A of Method 516.8). The determination of reliability is accomplished by evaluating the times to individual failures, if any, by conventional statistical techniques.

2.1.4.2 Reliability Growth test.

A reliability growth test is a test performed on one or a few prototype items at extreme test levels to quickly cause failures and, thus, identify weaknesses in materiel design. In many cases, the test level is increased in a stepwise manner to clearly identify the magnitude of the load needed to cause a specific type of failure. Design changes are then made and the failure rate of the materiel is monitored by either statistical reliability tests in the laboratory or valuations of failure data from service experience to verify that the design changes produced an improvement in reliability. Unlike statistical reliability tests, reliability growth tests do not simulate the magnitudes of the service environments, although some effort is often made to simulate the general characteristics of the environments; for example, random vibration would be used to test materiel exposed to a random vibration service environment.

2.1.5 Worthiness test.

When unqualified materiel is to be evaluated in the field, verification that the materiel will function satisfactorily is normally required for safety and/or test efficiency reasons. This is accomplished by environmental worthiness test. The worthiness test is identical to a qualification test except that it covers only the life cycle of the field evaluation. Levels are usually typical operating levels unless safety is involved; then maximum operating levels are necessary. Durations are either equivalent to a complete system/subsystem test, long enough to check materiel function, or an arbitrary short time (5 or 10 minutes). For safety driven worthiness test, the test item is considered to be consumed by the test (the test item may not be used in the field). An identical item of hardware is used in the field evaluation. When safety is not an issue, an item may be subjected to a minimum time functional test and then used in the field evaluation. When it is required to evaluate the cumulative environmental effects of vibration and environments such as temperature, altitude, humidity, leakage, or EMI/EMC, a single test item should be exposed to all environmental conditions. For air worthiness testing, a three step approach may be required. For example, this could include conducting an initial laboratory vibration test, followed by experimental flight testing to acquire the actual exposure levels, and ending with a qualification test based on the measured field data.

2.1.6 Environmental Stress Screening (ESS).

ESS is not an environmental simulation test representative of a life cycle event and is not a substitute for a qualification test. It is a production or maintenance acceptance inspection technique designed to quickly induce failures due to latent defects that would otherwise occur later during service. However, it is an environmental life cycle event and should be included as preconditioning or as part of the test as appropriate. Materiel may be subject to multiple ESS cycles, and maintenance ESS vibration exposures may differ from production acceptance exposures. ESS should be included in development tests only as appropriate to the test goals. The vibration environment is sometimes applied using relatively inexpensive, mechanically or pneumatically driven vibration testing machines (often referred to as impact or repetitive shock machines) that allow little or no control over the spectrum of the excitation. Hence, the screening test environment generally does not represent an accurate simulation of the service environment for the materiel.

2.2 Test Time Compression and the Fatigue Relationship.

The major cause of items failing to perform their intended function is material fatigue and wear accumulated over a time period as a result of vibration-induced stress. It is preferable for materiel to be tested in real-time so the effects of in-service conditions are simulated most effectively. However, in most instances real-time testing cannot be justified based on cost and/or schedule constraints and, therefore, it is customary to compress the service life environment into an equivalent laboratory test. For vibration environments that vary in severity during the materiel's

MIL-STD-810H
METHOD 514.8 ANNEX A

service life, the duration of the environment can often be reduced for testing by scaling the less severe segments of the vibration environment to the maximum levels of the environment by use of an acceptable algorithm. In many cases, scaling less severe segments to the maximum levels may still yield a test duration that is still too long to be practical. In such cases, the same algorithm may be used to further reduce test duration by increasing test amplitude. Provided that fatigue is a significant potential failure criterion for the materiel under test, this practice is acceptable within strict limits, notably that test amplitudes are not over exaggerated (or accelerated) simply to achieve short test durations. Such excessive amplitudes may lead to wholly unrepresentative failures, and cause suppliers to design materiel to withstand arbitrary tests rather than the in-service conditions.

The most commonly used method for calculating a reduction in test duration is the Miner-Palmgren hypothesis that uses a fatigue-based power law relationship to relate exposure time and amplitude. The mathematical expression and variable descriptions for this technique are illustrated below in Equations (1) and (4).

$$\frac{t_2}{t_1} = \left[\frac{S_1}{S_2} \right]^m \quad \text{Equation (1)}$$

where

t_1 = equivalent test time

t_2 = in-service time for specified condition

S_1 = severity (rms) at test condition

S_2 = severity (rms) at in-service condition

[The ratio S_1/S_2 is commonly known as the exaggeration factor.]

m = a value based on (but not equal to) the slope of the S-N curve for the appropriate material, where S represents the stress amplitude, and N represents the mean number of constant amplitude load applications expected to cause failure.

Fatigue damage can be calculated using either a stress life or strain life process. For the strain life technique, the number of cycles to failure, N_f , is computed from:

$$\varepsilon_a = \frac{\sigma'_f}{E} (2N_f)^b + \varepsilon'_f (2N_f)^c \quad \text{Equation (2)}$$

where

ε_a = test or environment strain amplitude

σ'_f = fatigue strength coefficient (material property)

E = modulus of elasticity (material property)

N_f = number of cycles to failure

b = fatigue strength exponent (material property)

ε'_f = fatigue ductility coefficient (material property)

c = fatigue ductility exponent (material property)

The fatigue strength portion of the equation represents the elastic portion of the S-N curve and the fatigue ductility portion of the equation represents the plastic portion. The stress life technique uses only the linear (elastic) portion of the curve (below yield) and is written as:

$$S_a = \sigma'_f (2N_f)^b \quad \text{Equation (3)}$$

Where

S_a = test or environment stress amplitude

Equation (3) is valid only in the finite life region with elastic nominal stresses (generally 1000 to 10,000,000 cycles

MIL-STD-810H
METHOD 514.8 ANNEX A

to failure). Fatigue damage outside this region can be described by a power law model in the form of Equation (1) with an exponent “ m ” that is not equal to “ b .” The value of “ m ” is strongly influenced by the material S-N curve, but fatigue life is also influenced by the surface finish, the treatment, the effect of mean stress correction, the contributions of elastic and plastic strain, the waveshape of the strain time history, etc. Therefore, the value of “ m ” is generally some proportion of the negative reciprocal of the slope of the S-N curve, known as the fatigue strength exponent and designated as “ $-1/b$.” Typical values of “ m ” are 80 percent of “ $-1/b$ ” for random waveshapes, and 60 percent of “ $-1/b$ ” for sinusoidal waveshapes. Historically, a value of $m = 7.5$ has been used for random environments, but values between 5 and 8 are commonly used. A value of 6 is commonly used for sinusoidal environments. This cumulative damage assumption is based on the fatigue properties of metals. Paragraph 6.1, reference aa (chapter 35) recommends that Miner’s cumulative damage theory not be used for composite materials. However, a “wearout model,” defined as “the deterioration of a composite structure to the point where it can no longer fulfill its intended purpose,” is shown as a power law model in the form of Equation (1) with variable exponents dependent upon the type of composite system. It is recommended that test time compression for composite structures be treated on a case-by-case basis.

Since most vibration environments are expressed in terms of the auto spectral density function, Equation (1) can also be formulated as:

$$\frac{t_2}{t_1} = \left[\frac{W(f)_1}{W(f)_2} \right]^{m/2} \quad \text{Equation (4)}$$

where:

t_1 = equivalent test time

t_2 = in-service time for specified condition

$W(f)_1$ = ASD at test condition, g^2/Hz

$W(f)_2$ = ASD at in-service condition, g^2/Hz

[The ratio $W(f)_1/W(f)_2$ is commonly known as the exaggeration factor]

m = as stated in Equation (1)

In many instances these equations appear to offer a satisfactory solution. However, caution should always be exercised in the application of the equations. Some methods of characterizing vibration severities, notably ASDs, do not necessarily reproduce under laboratory testing the same strain responses as those experienced under in-service conditions. Exaggeration factors for materials whose fatigue characteristics are unknown or for failure mechanisms other than fatigue (such as loosening of threaded connections) cannot be calculated. Real time test levels and durations should be used in these instances unless there is sufficient information about the particular application to allow for the use of a reasonable exaggeration factor. It is recommended that the exaggeration factor be kept to a minimum value consistent with the constraints of in-service time and desired test time, and should generally not exceed values of 2 (S_1/S_2) or 4 ($W(f)_1/W(f)_2$).

Note: Using material S-N curves results in different equivalencies for different parts in a given test item. A decision will be required as to which equivalency to use to establish test criteria.

2.3 Vibration Characterization.

The majority of vibration experienced by materiel in operational service is broadband in spectral content. That is, vibration is present at all frequencies over a relatively wide frequency range at varying intensities. Vibration amplitudes may vary randomly, periodically, or as a combination of mixed random and periodic.

MIL-STD-810H
METHOD 514.8 ANNEX A

2.3.1 Random vibration.

Random vibration is expressed as auto spectral density (also referred to as power spectral density, or PSD). The auto spectral density (ASD) at a given frequency is the square of the root mean square (rms) value of the acceleration, divided by the bandwidth of the measurement. Accuracy of spectral values depends on the product of the measurement bandwidth and the time over which the spectral value is computed. The normalized random error for a spectral estimate is given by $1/\sqrt{BT}$, where B is the analysis bandwidth in Hz, and T is the averaging time in seconds. In general, use the smallest practical bandwidth or minimum frequency resolution bandwidth. Most commercially available vibration control systems assume that the acceleration amplitude has a normal (Gaussian) distribution. Other amplitude distributions may be appropriate in specific cases. Ensure that test and analysis hardware and software are appropriate when non-Gaussian distributions are encountered (refer to Method 525.1).

- a. Frequency range. ASD is defined over a relevant frequency range. This range is between the lowest and highest frequencies at which the materiel may be effectively excited by mechanical vibration. Typically, the low frequency is one half the frequency of the lowest resonance of the materiel, or the lowest frequency at which significant vibration exists in the environment. The high frequency is two times the highest materiel resonant frequency, the highest frequency at which significant vibration exists in the environment, or the highest frequency at which vibration can be effectively transmitted mechanically. Historically due to limitations in fixture transmissibility and shaker resonances, testing has been limited to a high frequency of 2000 Hz for mechanically transmitted vibration. However this limitation has changed with some facilities now performing system level tests to 3000 Hz and component level tests to 4000 Hz. When higher frequencies are needed, it may be necessary to augment the vibration with acoustic noise (see Method 523.4).
- b. Rms values. The use of rms values to specify random vibration is not sufficient. The spectrum rms value is the square root of the area under the spectral density curve over the total frequency range. It contains no frequency information. Rms values are useful as a general error check, and as a measure of power needed to run a vibration shaker. Definitions of vibration should always include frequency spectra.

2.3.2 Sinusoidal vibration.

Sine vibration is expressed as acceleration and a frequency. An environment dominated by sine vibration is characterized by a fundamental frequency and harmonics (multiples) of that fundamental. Often there will be more than one fundamental frequency. Each fundamental will generate harmonics. The service vibration environment in some cases (low performance propeller aircraft and helicopters for example) contains excitation that is basically sinusoidal in nature, and with a very low broadband background. The excitation derives from engine rotational speeds, propeller and turbine blade passage frequencies, rotor blade passage, and their harmonics. Environments such as this may be best simulated by a sinusoidal test. Ensure the frequency range of the sinusoidal exposure is representative of the platform environment. In many cases the broadband random may be of sufficient amplitude that the concept of simply omitting the broadband energy and conducting a pure sine test is either questionable or not acceptable. If so, refer to paragraph 2.3.3.

2.3.3 Mixed broadband and narrowband vibration.

In some cases, the vibration environment is characterized by quasi-periodic excitation from reciprocating or rotating structures and mechanisms (e.g., rotor blades, propellers, pistons). When this form of excitation predominates, source dwell vibration is appropriate. Source dwell is characterized by broadband random vibration, with higher level narrowband random, or sinusoidal vibration superimposed. Since data reduction techniques affect the apparent amplitudes of these different types of signals, exercise care when determining levels of random and sinusoidal vibration from measured data.

- a. Narrowband random over broadband random. Ensure that the amplitudes and frequencies of the total spectrum envelope the environment. The narrowband bandwidth(s) should encompass or be cycled through frequencies representative of variations of the environment and variations of materiel resonant frequency (see paragraph 2.4.3 below).
- b. Sinusoid(s) over broadband random background. Ensure the random spectrum is continuous over the frequency range, and that it envelopes all of the environment except for the amplitude(s) to be represented by the sinusoid(s). The sinusoid(s) amplitude(s) should envelope the sinusoid(s) in the environment. Cycle

MIL-STD-810H
METHOD 514.8 ANNEX A

the sinusoid(s) frequency(s) through bands representative of frequency variations in the environment and resonant frequency variations in materiel (see paragraph 2.4.3 below).

2.3.4 Transient vibration.

Transient vibration is a time-varying "windowed" portion of a random vibration that is of comparatively short duration (e.g., 0.5 second to 7.5 seconds). Currently, such a measured environment is replicated in the laboratory on a vibration exciter under waveform control. Verification of the laboratory test is provided by (1) display of the laboratory measured amplitude time history; (2) an optimally smooth estimate of the amplitude time history time-varying root-mean-square, and (3) either an energy spectral density estimate, or a Shock Response Spectrum (SRS) estimate for comparatively short environments (transient vibration duration less than the period of the first natural mode of the test item), or a time-varying auto spectral density estimate of longer duration environments, e.g., 2.5 to 7.5 seconds. In general, since the environment is being replicated in the laboratory under waveform control, if the impulse response function of the system is correctly determined and correctly applied, the replication should be nearly identical to the measured environment. The transient vibration environment is an important environment for stores resident in platform weapon bays that may be exposed to such environments many times in the life of training missions. See paragraph 6.1, references c and bb; Method 516.8; and Method 525.2 for procedures relative to transient vibration.

2.3.5 Random versus sinusoidal vibration equivalence.

In the past, most vibration was characterized in terms of sinusoids. Currently, most vibration is correctly understood to be random in nature and is characterized as such. This results in a demand to determine equivalence between random and sine vibration. This demand is generated by the need to use materiel that was developed to sine requirements.

- a. General equivalence. Sine and random characterizations of vibration are based on distinctly different sets of mathematics. In order to compare the effects of given random and sine vibration on materiel, it is necessary to know the details of materiel dynamic response. A general definition of equivalence is not feasible.
- b. G-rms. Often, attempts are made to compare the peak acceleration of sine to the rms acceleration of random. The only similarity between these measures is the dimensional units that are typically acceleration in standard gravity units (g). Peak sine acceleration is the maximum acceleration at one frequency (see paragraph 2.3.2). Random rms is the square root of the area under a spectral density curve (see paragraph 2.3.1). These are not equivalent.

2.3.6 Combination of test spectra

When combining test spectra to develop an envelope or weighted average of multiple vibration profiles, refer to the discussion and techniques presented in Annex F of this method.

2.4 Platform/Materiel and Fixture/Test Item Interaction.

Generally, it is assumed that the vibration environment of the materiel is not affected by the materiel itself. That is, the vibration of the platform at the materiel attachment point would be the same whether or not the materiel is attached. Since the entire platform, including all materiel, vibrates as a system, this is not strictly correct. However, when the materiel does not add significantly to the mass or stiffness of the platform, the assumption is correct within reasonable accuracy. The following paragraphs discuss the limitations of this assumption. These effects also apply to sub-elements within materiel and to the interactions of materiel with vibration excitation devices (shakers, slip tables, fixtures, etc.).

2.4.1 Mechanical impedance.

- a. Large mass items. At platform natural frequencies where structural response of the platform is high, the materiel will load the supporting structures. That is, the mass of the materiel is added to the mass of the structure, and it inertially resists structural motions. If the materiel mass is large compared to the platform mass, it causes the entire system to vibrate differently by lowering natural frequencies and changing mode shapes. If the materiel inertia is large compared to the stiffness of the local support structure, it causes the local support to flex, introducing new low frequency local resonances. These new local resonances may act as vibration isolators (see paragraph 2.4.2 below).

MIL-STD-810H
METHOD 514.8 ANNEX A

- b. Items acting as structural members. When materiel is installed such that it acts as a structural member of the platform, it will affect vibrations and it will be structurally loaded. This is particularly important for relatively large materiel items, but it applies to materiel of any size. In these cases, the materiel structure adds to the stiffness of the platform and may significantly affect vibration modes and frequencies. Further, the materiel will be subjected to structural loads for which it may not have been designed. An example is a beam tied down to the cargo deck of a truck, aircraft, or ship. If the tie-downs are not designed to slip at appropriate points, the beam becomes a structural part of the deck. When the deck bends or twists, the beam is loaded and it changes the load paths of the platform structure. This may be catastrophic for the beam, the platform, or both. Be careful in the design of structural attachments to assure that the materiel does not act as a structural member.
- c. Large item mass relative to supporting structures. When materiel items are small relative to the overall platform, but large relative to supporting structures, account for the change in local vibration levels, if practical. This effect is discussed in Annex D, paragraph 2.1 for materiel mounted in jet aircraft. Due to differences in environments, relative sizes, and structural methods, the factor defined in Annex C, Table 514.8C-X is not applicable to materiel mounted in small, unmanned aircraft.
- d. Large item size/mass relative to platform. When materiel is large in size or mass relative to the platform, always consider the potential of damage to the platform as a result of materiel vibration. It is imperative to consider these effects in the design of vibration test fixtures. Otherwise, the vibration transmitted to the test item may be greatly different than intended.

2.4.2 Vibration isolation.

Vibration isolators (shock mounts), isolated shelves, and other vibration isolation devices add low-frequency resonances to the dynamic system that attenuate high-frequency vibration inputs to materiel. Vibration inputs at the isolation frequencies (materiel six degree-of-freedom rigid body modes) are amplified, resulting in substantial rigid body motions of the isolated materiel. Effective performance of these devices depends on adequate frequency separation (minimum factor of two) between materiel resonant frequencies and isolation frequencies, and on adequate sway space (clearance around isolated materiel) to avoid impacts of the isolated materiel with surrounding materiel (possibly also vibration isolated and moving) and structure.

- a. Sway space. Include sway amplitude and isolation characteristics (transmissibility versus frequency) in all design analyses and measure them in all vibration tests. Isolation devices are nonlinear with amplitude. Evaluate these parameters at vibration levels ranging from minimum to maximum. These comments also apply to isolated sub-elements within materiel items.
- b. Minimum ruggedness. All materiel should have a minimum level of ruggedness, even if protected by isolation in service use and shipping. Thus, when materiel development does not include all shipping and handling environments of the materiel's life cycle, include the appropriate minimum integrity exposures in materiel (Annex E, paragraph 2.1.1).

2.4.3 Materiel resonant frequency variation.

The installed resonant frequencies of materiel may vary from those of the laboratory test. One cause is the small variations between serial items from an assembly process. Tightness of joints, slight differences in dimensions of parts and subassemblies, and similar differences affect both the resonant frequencies and the damping of the various modes of the item. A second cause is the interaction between the materiel and the mounting. As installed for field use, a materiel item is tied to mounting points that have an undefined local flexibility, and that move relative to each other in six degrees of freedom as the platform structure vibrates in its modes. In a typical laboratory test, the test item is tied to a massive, very stiff fixture intended to transmit single axis vibration uniformly to each mounting point. In each case, the mounting participates in the vibration modes of the materiel item and, in each case, the influence is different. When defining test criteria, consider these influences. Both in the cases of measured data and arbitrary criteria, add an allowance to narrow band spectral elements.

2.5 Modal Test and Analysis.

Modal test and analysis is a technique for determining the structural dynamic characteristics of materiel and test fixtures. Modal tests (paragraph 6.1, reference cc), also known as ground vibration tests (GVT) and ground vibration surveys (GVS), apply a known dynamic input to the test item, and the resulting responses are measured and stored. Modal analysis methods are applied to the measured data to extract modal parameters (resonant frequencies, mode

MIL-STD-810H
METHOD 514.8 ANNEX A

shapes, modal damping, etc.). Modal parameters are used to confirm or generate analytical models, investigate problems, determine appropriate instrumentation locations, evaluate measured vibration data, design test fixtures, etc. Modal analysis methods range from frequency domain, single degree of freedom methods, to time domain, multi-degree of freedom methods (paragraph 6.1, references dd and ee).

2.5.1 Modal test techniques.

Experimental modal tests involve excitation of a structure with a measured force while measuring the acceleration response and computing the frequency response functions (FRF) at location(s) of interest for subsequent modal analysis. Excitation of the structure for modal test may be accomplished in various ways. The simplest method, a modal impact test, consists of excitation with a modally tuned impact hammer instrumented with a force gage to produce a low force impact on the structure that approximates an impulse function. This technique is commonly used as a quick check of resonant frequencies for fixtures and installed components. A more sophisticated approach would use burst random excitation with small vibration exciter(s) attached to a structure that is instrumented with an array of accelerometers. Modal tests with vibration exciters is more commonly used for high channel count modal tests of complex structures with more precise measurements required for the development of mode shapes and verification of analytical models. Sinusoidal and broadband random vibration excitation of a test fixture/item mounted on large vibration exciters are also options to check resonant frequencies for laboratory vibration test setups. Select methodology that will result in well-understood, usable data, and that will provide the level or detail needed for the specific test goals.

2.5.2 Material non-linear behavior.

Dynamic inputs should be at as realistic levels as possible, and at as many levels as practical because materiel response is generally nonlinear with amplitude. Modal parameters determined through modal test and analysis techniques are typically based on assumption of structural linearity. Linearity checks can be conducted during modal tests by collecting and analyzing data at various force levels and identifying frequency shifts, if any, in the resonant frequencies. For structures that exhibit highly non-linear behavior, additional analysis will be required to extrapolate modal test results to the expected life cycle vibration environments.

2.6 Aerodynamic Effects.

A primary source of vibration in aircraft and aircraft stores is the aerodynamic flow over the vehicle. Oscillating pressures (turbulence) within the flow drive vibration of the airframe surfaces. These pressures and, thus, the vibration are a linear function of dynamic pressure, and a non-linear function of Mach number. When a flow becomes supersonic, it smooths out and turbulence drops off. Then, as speed increases, further turbulence builds up again. This phenomenon is well illustrated in the vibration data contained in paragraph 6.1, reference k. The Mach corrections given in Annex D, Table 514.8D-IV are based on an average of this data. The following definitions and the values and the formulas of Annex D, Table 514.8D-V are provided for use in calculating airspeeds and dynamic pressures. The source of the formulas is paragraph 6.1, reference ff, and the source of the atmospheric values is paragraph 6.1, reference kk.

2.6.1 Dynamic pressure.

The total pressure of a gas acting on an object moving through it is made up of static pressure plus dynamic pressure (q). The proportions vary with speed of the body through the gas. Dynamic pressure is related to speed by

$q = 1/2 \rho V^2$ where ρ is the density of the gas, and V is the velocity of the object through the gas.

2.6.2 Airspeed.

The speed of an aircraft moving through the atmosphere is measured in terms of airspeed or Mach number. There are several forms of airspeed designation that are discussed below. At sea level these are equal, but as altitude increases they diverge. Equations and data required for airspeed and dynamic pressure calculations are provided in Annex D, Table 514.8D-V. These are based on paragraph 6.1, references ff and kk.

- a. Calibrated airspeed. Airspeed is usually specified and measured in calibrated airspeed. Calibrated airspeed is typically expressed in nautical miles per hour (knots) and designated knots calibrated air speed (K_{cas}). K_{cas} is not true airspeed. It is derived from quantities that are directly measurable in flight. Since it is not true airspeed, it cannot be used in the simple formula for q given above.

MIL-STD-810H
METHOD 514.8 ANNEX A

- b. Indicated airspeed. Another form of airspeed measurement is indicated airspeed. Calibrated airspeed is indicated airspeed when empirical corrections are added to account for factors in the specific aircraft installation. Indicated airspeed is expressed in various units (kilometers per hour, miles per hour, and knots), but in military aircraft it is normally in knots indicated airspeed (K_{ias}).
- c. Equivalent airspeed. Equivalent airspeed is a form directly related to dynamic pressure. It is sometimes used in engineering calculations since other forces (lift, drag, and structural air-loads) acting on an airframe are also proportional to dynamic pressure. However, it is not used in airspeed measurement systems or flight handbooks. Equivalent airspeed may be expressed in various units, but it is usually seen as knots equivalent airspeed (K_{eas}).
- d. True airspeed. This is the actual airspeed. To calculate true airspeed with an aircraft air data system, local atmospheric properties must be accurately known. This was not practical until recent years and aircraft generally do not use true airspeed in handbooks or to navigate. True airspeed may be expressed in various units but it is usually seen as knots true airspeed (K_{tas}).
- e. Mach number. Mach number is the ratio of true airspeed to the speed of sound. When Mach number is measured by an aircraft air data system, it is true Mach number.

2.6.3 Altitude.

Aircraft air data systems measure local atmospheric pressure and convert this value to pressure altitude through a standard atmosphere model that relates pressure, temperature, and density. Pressure altitude is used in the equations relating airspeeds and dynamic pressure. Care must be exercised to assure that altitudes are pressure altitudes. Often, low altitude values for modern military aircraft are given as absolute height above local terrain. These values should be changed to pressure altitude values. Guidance from engineers familiar with mission profile development is required to make this adjustment.

2.7 Similarity.

It is often desirable to use materiel in an application other than that for which it was developed. Also, changes are made to existing materiel or the environmental exposures because of an application change. The question arises as to how to verify that the materiel is suitable for the application? This is usually accomplished through a process called "qualification by similarity." Unfortunately, this process has never had a generally accepted definition. In practice it sometimes devolves to a paper exercise that provides traceability but has no engineering content. The following paragraphs are an adaptation of a set of criterion that was provided to an Air Force avionics program. It is suggested as a basis for vibration similarity criteria. Tailor the criteria for materiel type, platform environments, and program restraints. Change the emphasis from circuit cards to the particular critical elements when the materiel is not an electronic box. Also, change the fatigue equation exponents as appropriate.

2.7.1 Unmodified materiel.

Qualify unmodified materiel by documented evidence that one of the following is met:

- a. The materiel was successfully qualified by test to vibration criteria that equals or exceeds the vibration requirements of the application.
- b. The materiel has demonstrated acceptable reliability in an application where vibration environments and exposure durations are equal to, or more stringent than the vibration requirements of the application.
- c. The materiel was successfully qualified by test to vibration criteria that falls short of the application ASD requirements in very narrow bands of energy (<5 percent of the test bandwidth) by no more than 3 dB, contingent that the materiel under test has no resonant frequencies within the subject narrow band, and that the G-rms falls within a minimum of 90 percent of the application and subsequently the materiel demonstrated acceptable reliability.

2.7.2 Modified materiel.

Qualify modified materiel by documented evidence that the unmodified materiel meets the vibration requirements for the application supplemented by analyses and/or test data demonstrating that the modified materiel is dynamically similar to the unmodified materiel.

MIL-STD-810H
METHOD 514.8 ANNEX A

2.7.3 Equal vibration environment.

Previous tests or other vibration exposures are considered to equal the application requirement when ALL of the following conditions are met:

- a. Previous exposures were the same type of vibration as the application requirement. That is, random vibration must be compared to random criteria, and sine must be compared to sine criteria.
- b. The exposure frequency range encompasses the application frequency range. Use a low frequency limit of the range that is the low frequency limit of the application requirement, or 1/2 of the lowest materiel resonant frequency, whichever is higher. The high frequency limit of the range is the high frequency limit of the application requirement.
- c. The exposure level (acceleration spectral density level or peak sinusoidal acceleration as applicable) was no more than 3.0 dB below the application requirement at any frequency, and was at or above the requirement for at least 80 percent of the total bandwidth.
- d. The fatigue damage potential of the exposure(s) is not less than 50 percent of the application fatigue damage potential at each frequency, and the fatigue damage potential of the exposure(s) equals or exceeds the application fatigue damage potential over 80 percent of the frequency range. State fatigue damage potentials as totaled equivalent exposure times at maximum application levels. Base summations and equivalencies on the relationships shown in paragraph 2.2 of this Annex. These relationships should be used with metal structures only.

2.7.4 Reliability data.

Use field reliability data that meets all of the following criteria:

- a. The numbers of fielded materiel from which the data were taken are sufficient to statistically represent the specific materiel item.
- b. The field service seen by the materiel from which the data were taken is representative of the design environmental life cycle.
- c. The field reliability data satisfies maintainability, mission readiness, mission completion, and safety requirements.

2.7.5 Critical resonant response.

Evaluate the first three natural frequencies of the chassis, and the first natural frequency of each sub assembly with the following procedure:

- a. Determine the required set (first set) of natural frequencies by test.
- b. Compare maximum levels at which the materiel is required to operate for the original qualification and for the application environment. Define the set (second set) of frequencies at which the application environment exceeds the original levels.
- c. Determine which resonances of the first set coincide with the frequencies of the second set. Show by test or analysis that the materiel will function as required when these resonances are exposed to the application environment maximum levels.
- d. Use the procedure of paragraph 2.2 above to compare the fatigue damage potential of the original qualification and the application environment. Define the set (third set) of frequencies at which the application fatigue damage potential exceeds the fatigue damage potential of the original criteria.
- e. Determine which resonances of the first set coincide with the frequencies of the third set. Show by test or analysis that the required materiel life will be obtained when these resonances are exposed to the application fatigue damage potential.

2.7.6 Dynamic similarity.

Consider modified materiel as dynamically similar to baseline materiel when all of the following apply (circuit card used as an example):

MIL-STD-810H
METHOD 514.8 ANNEX A

- a. The total change in mass of the unit and of each subassembly is within ± 10 percent.
- b. The unit center of gravity is within ± 10 percent of the original location in any direction.
- c. The mounting configuration is unchanged.
- d. The mounting configuration of circuit cards is unchanged.
- e. The first three natural frequencies of the chassis and the first natural frequency of each subassembly are within ± 5 percent of the original frequencies.
- f. The first natural frequency of each circuit board is within ± 10 percent of the original frequency.
- g. Each modified circuit card is vibrated for one hour in the axis perpendicular to the plane of the board. Use a test exposure that is $0.04 \text{ g}^2/\text{Hz}$ from 15 to 1000 Hz rolled off at 6 dB per octave to 2000 Hz. Maintain electrical continuity throughout the card during and after the test. (Where vibration levels and durations at board level are known, these may be substituted for the stated exposure.)
- h. Changes to mounts, chassis, internal support structures, and circuit card materials are to materials with equal or greater high cycle fatigue strength.

MIL-STD-810H
METHOD 514.8, ANNEX B**METHOD 514.8, ANNEX B****Manufacture / Maintenance Tailoring Guidance for Vibration Exposure Definition****1. SCOPE.****1.1 Purpose.**

This Annex provides guidance intended to be useful in determining the vibration levels and durations related to the manufacture and/or maintenance of materiel.

1.2 Application.

Recommended actual environments be measured, and materiel life cycle durations be used to develop materiel design and test criteria whenever possible. Existing databases can sometimes be used in lieu of measurements. A preliminary environmental life cycle based on data provided herein can be useful as a planning tool. A preliminary life cycle definition can be used to concentrate limited resources on those vibration exposures most significant to the materiel. Guidance for setting design and test exposure values is given below with descriptions of vibration environments of many typical life cycle events. Suggested alternate criteria (levels and durations) or other guidance are recommended for those cases where measured data defining the actual environments are not available.

1.3 Limitations.

See paragraph 1.3 in the front part of this Method.

2. MANUFACTURE/MAINTENANCE.

The following areas are not usually considered as part of the environmental life cycle. However these activities may result in vibratory fatigue damage to the materiel. Evaluate these environments and, where significant, include them in design and as preconditioning to environmental tests.

2.1 Category 1 - Manufacturing/Maintenance Processes.

All materiel will experience some vibration during manufacture and maintenance. When different serial number items (lots) experience significant differences in vibration exposure during manufacture, select vibration test specimens, exposure levels, and exposure durations from those lots that experience the maximum vibration exposure. For maintenance, evaluate this environment and, when significant, include it in design and test exposures, along with the exposure levels and durations.

2.2 Category 2 - Shipping and Handling.

Parts, subassemblies, and materiel are subject to vibration during handling and transportation within and between manufacturing and maintenance facilities. When there are significant differences between exposures to different serial number items (lots), select vibration test articles from those lots that experience the maximum vibration exposure, and determine exposure durations from manufacturing and maintenance planning. Where transportation is by normal commercial means, use the applicable guidance of Annex C, paragraph 2. For other means of transportation, measure exposure levels.

2.3 Category 3 - Environmental Stress Screening (ESS).

Parts, subassemblies, and materiel are often subject to ESS vibration exposures during manufacturing and maintenance. While exposure levels are identical for each like item, exposure durations are not. Items can be subjected to multiple cycles of ESS prior to production acceptance. Further, exposures are often significant with respect to vibratory fatigue. Include maximum allowable exposures in design calculations and as environmental test preconditioning. Use specified exposure levels and the maximum allowable production and maintenance exposure durations for part, subassembly, and materiel ESS.

MIL-STD-810H
METHOD 514.8, ANNEX B

(This page is intentionally blank.)

MIL-STD-810H
METHOD 514.8, ANNEX C**METHOD 514.8, ANNEX C****Transportation Tailoring Guidance for Vibration Exposure Definition**

NOTE: Unless specifically noted, all document references refer to paragraph 6.1 of the front part of this Method.

1. SCOPE.**1.1 Purpose.**

This Annex provides information on transportation environments. It is intended to be useful in determining the vibration levels and durations of environmental life cycle events, and in defining the tests necessary to develop materiel to operate in and survive these environments.

1.2 Application.

It is recommended that actual environments be measured and materiel life cycle durations be used to develop materiel design and test criteria whenever possible. Existing databases can sometimes be used in lieu of measurements. A preliminary environmental life cycle based on data provided herein can be useful as a planning tool. A preliminary life cycle definition can be used to concentrate limited resources on those vibration exposures most significant to the materiel. Guidance for setting design and test exposure values is given below with descriptions of vibration environments of many typical life cycle events. Suggested alternate criteria (levels and durations) or other guidance is recommended for those cases where measured data defining the actual environments are not available. Table 514.8-I in the front part of this Method contains an outline of the following paragraph with references to the paragraph numbers. For transportation vibration typical (default) missions are illustrated in Figure 514.8C-1.

1.3 Limitations.

See paragraph 1.3 in the front part of this Method.

2. TRANSPORTATION.

- a. Test item configuration. In all transportation exposures, configure the test item (packaged or not) as appropriate for the specific transportation phase. The following criteria are defined as inputs to packaged (or transportation configured) materiel. Use test items that are real materiel in real packaging. Making a vibration measurement on a simulated (dummy) item and comparing this to other vibration exposures of the materiel life cycle is generally not adequate. See paragraph 1.3b in the front part of this Method, and Annex A, paragraph 2.4.
- b. Configuration variation with transportation phase. Packaging is sometimes reconfigured for different transportation phases. For example, shipping containers may have low frequency shock isolation systems to protect against dropping and bumping while loading and unloading. This low frequency system may be bypassed by blocking or bracing when the container is loaded in the cargo area of the transport vehicle. The guidance provided below is for the vibration portion of the environment while being transported by various vehicles. See Method 516.8 for guidance on shock environments.
- c. Shock or vibration isolation. Materiel as packaged for shipment should not have very low resonant frequencies (see Annex A, paragraph 2.4.2). Otherwise, damage due to impacting of fixed and suspended elements or over-extension of suspension elements is likely. Packaging/configuring for transport should include blocking softly suspended internal elements to prevent low frequency relative motion between suspended elements and surrounding structures. The minimum suspension frequency should be two times the frequency of any low frequency spike or hump in the input spectra. In addition, the minimum suspension frequency of materiel packaged for transport on fixed wing aircraft should be 20 Hz (see paragraphs 2.4 and 2.5 below).
- d. Materiel orientation. When packaged materiel orientation is fixed relative to the transportation vehicle, vibration exposures should be related to vehicle orientation (e.g., vertical, longitudinal, transverse). When orientation within the vehicle can vary, vibration exposures should be derived from envelopes of possible orientations (e.g., longitudinal and transverse combined, vertical). Many of the profiles provided below include an enveloped profile for when the test item orientation relative to the vehicle is unknown or

MIL-STD-810H
METHOD 514.8, ANNEX C

variable.

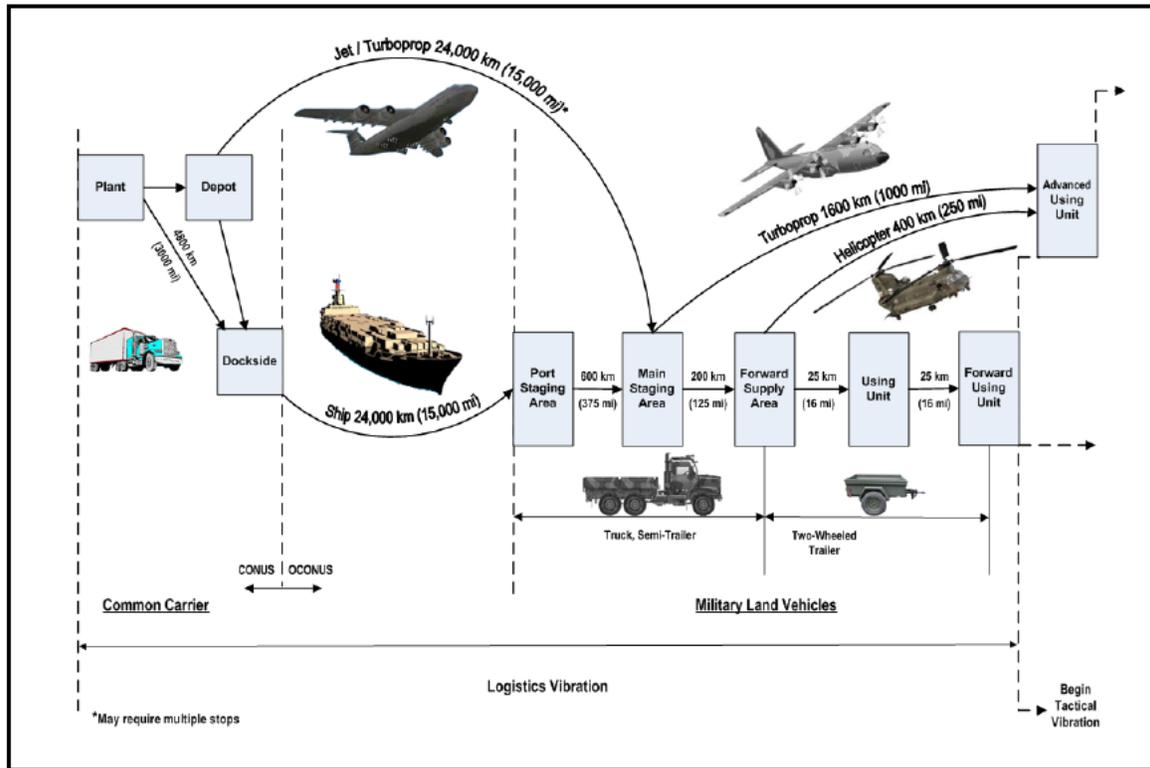


Figure 514.8C-1. Typical mission / field transportation scenario.^{1, 2}

¹See paragraph 6.1, reference m.

²In the event that tracked vehicles are identified in LCEP, they should be considered in the typical mission/field transportation scenario. See paragraph 6.1, reference d.

NOTE: This Figure represents only one mission in the life cycle of materiel. Determine the number of missions in the life cycle of the materiel from the LCEP. See Part One Paragraph 4.1.2c for Whole Life Assessment (WLA) and In Service Surveillance (ISS) considerations.

2.1 Category 4 - Truck/Trailer - Secured Cargo.

These transportation environments are characterized by broadband vibration resulting from the interaction of vehicle suspension and structures with road and surface discontinuities. Representative conditions experienced on moving materiel from point of manufacture to end-use are depicted in Part One, Figure 1-4a. This environment may be divided into two phases, truck transportation over US highways, and mission/field transportation. Mission/field transportation is further broken down into two-wheeled trailer and wheeled vehicles categories.

2.1.1 Truck transportation over US highways. This involves movement from the manufacturer's plant to any continental United States storage or user installation. (Data are available for US roads, but not for roads in other countries.) This movement is usually accomplished by large truck and/or tractor-trailer combination. Mileage for this transportation generally ranges from 3200 to 6400 kilometers (2000 to 4000 miles) over improved or paved highways.

2.1.2 Mission/field transportation. This involves movement of materiel as cargo where the platform may be two-wheeled trailers, 2-1/2 to 10 ton trucks, and/or semi-trailers. Typical distances for this phase are 480 to 800 kilometers (300 to 500 miles). Road conditions for mission/field support differ from the common carrier in that, in addition to the paved highway, the vehicles will traverse unimproved roads and unprepared terrain (off-the-road) under combat conditions.

MIL-STD-810H
METHOD 514.8, ANNEX C

2.1.3 Exposure levels. Whenever possible, measure vibration on the transport vehicles using the road conditions (surfaces, speeds, and maneuvers) of the materiel's LCEP. Include realistic load configurations (approximately 75 percent of the vehicle load capacity by weight). Use these data to develop exposure levels per Annex F. Alternatively, derive exposure levels as discussed below.

a. Truck transportation over US highways. Derive exposure levels from Figure 514.8C-2 and Table 514.8C-I, or, if the test item orientation is unknown or variable see Figure 514.8C-3 and Table 514.8C-II for exposure levels. These figures are based on data measured at the cargo floor of seven different configurations of trucks and semitrailer combinations. Both conventional suspensions and air-cushioned suspensions are represented. The data were collected from typical interstate highways (including rough portions as part of the database).

Test Schedule: Secured Cargo – Common Carrier (See paragraph 6.1, reference oo.)

Vehicles Used for Composite: This schedule is based on data measured at the cargo floor of seven different configurations of trucks and semitrailer combinations. Both conventional suspensions and air-cushioned suspensions are represented. The data were collected from typical interstate highways with rough portions as part of the database:

Measured Locations: Measurements were made on the cargo floor of the vehicles tested.

Type of Test Load: Unknown.

Scenario to be Simulated: 1609 km (1000 miles) on interstate highways.

Assumptions (Scenario, Load, Failure Mechanism, etc.):

100 percent of scenario is on improved interstate highways

Fatigue is the failure mode

Test Time Compression: This test represents 1609 km (1000 mi) in 60 minutes so there is time compression involved. The algorithm used to determine the exaggeration factor is unknown.

Test Time: 60 minutes per axis

Exaggeration Factor: Unknown

Method of Combination of Spectra: Unknown.

Location of Control Accelerometer(s): 2 accelerometers at opposite corners, within 30 cm (12 in.) from test item

Recommended Control Scheme: Average (Extremal control may be appropriate for some applications)

For movement direction definitions, see paragraph 4.4 in the front part of this Method.

RMS Acceleration:^{1,2} (G-rms): Vertical – 1.08;

Transverse – 0.21;

Longitudinal – 0.76;

Envelope – 1.17.

Velocity (in/sec) (peak single amplitude):^{1,2}

Vertical – 9.68;

Transverse – 1.23;

Longitudinal – 6.11;

Envelope – 9.69.

MIL-STD-810H
METHOD 514.8, ANNEX C

Displacement (in) (peak double amplitude):^{1,2}

Vertical – 0.37

Transverse – 0.04;

Longitudinal – 0.24;

Envelope – 0.37.

¹ Approximate values for a Gaussian random distribution which may vary based on the control system and spectral resolution. Peak velocity and displacement values are based on an acceleration maximum of three times the standard deviation (3σ) and a spectral resolution of 1 Hz.

² For test items for which the test item orientation is unknown or variable the Envelope profile should be run for all three axes (Figure 514.8C-3 and Table 514.8C-II).

MIL-STD-810H
METHOD 514.8, ANNEX C

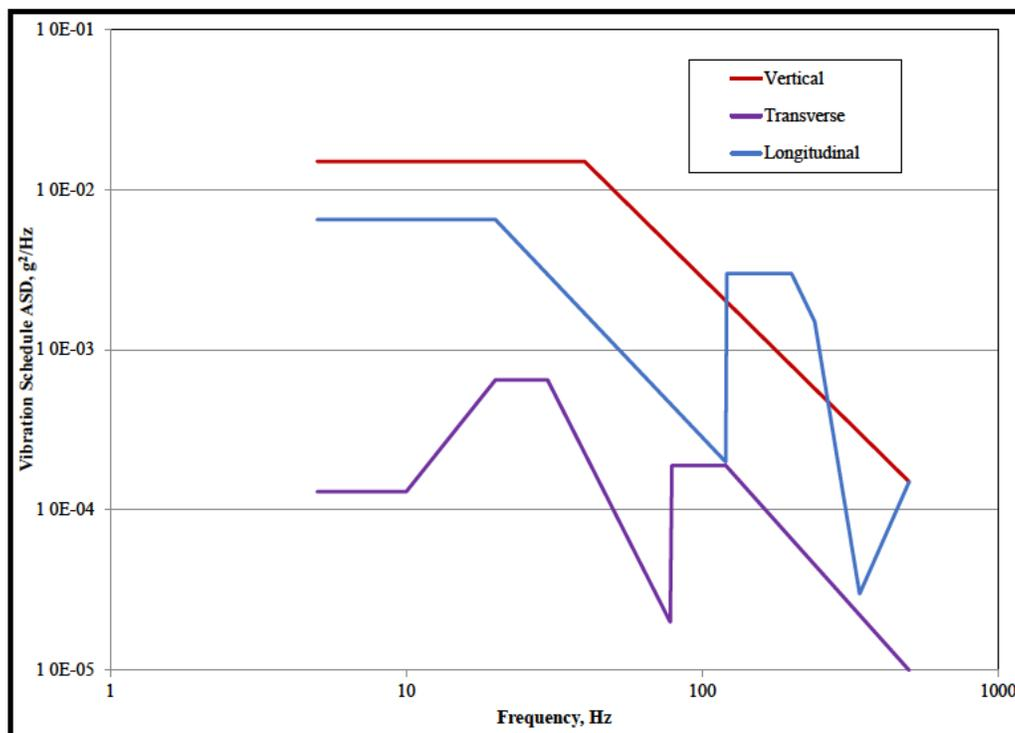


Figure 514.8C-2 – Category 4 – Common carrier (US highway truck vibration exposure).

Table 514.8C-I. Category 4 – Common carrier (Break points for curves of Figure 514.8C-2).

Vertical		Transverse		Longitudinal	
Frequency, Hz	ASD, g ² /Hz	Frequency, Hz	ASD, g ² /Hz	Frequency, Hz	ASD, g ² /Hz
5	0.015	5	0.00013	5	0.0065
40	0.015	10	0.00013	20	0.0065
500	0.00015	20	0.00065	120	0.0002
		30	0.00065	121	0.003
		78	0.00002	200	0.003
		79	0.00019	240	0.0015
		120	0.00019	340	0.00003
		500	0.00001	500	0.00015
rms = 1.08 g		rms = 0.21 g		rms = 0.76 g	

MIL-STD-810H
METHOD 514.8, ANNEX C

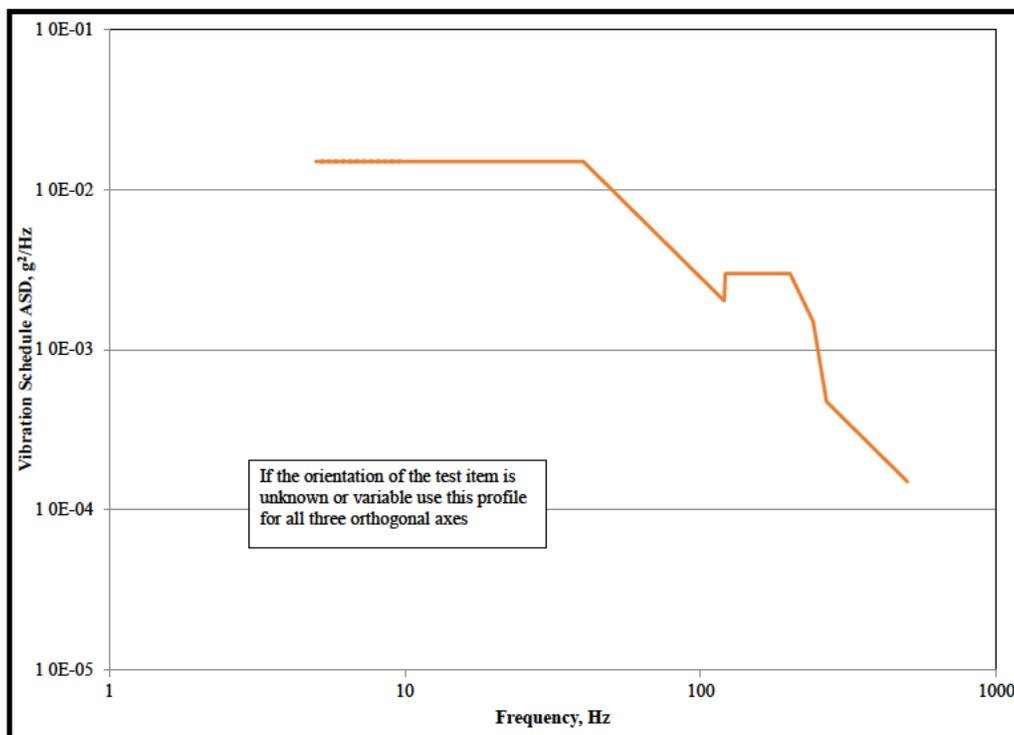


Figure 514.8C-3 – Category 4 – Common carrier for unknown orientation (US highway truck vibration exposure).

Table 514.8C-II. Category 4 – Common carrier for unknown orientation (Break points for curves of Figure 514.8C-3).

Envelope	
Frequency, Hz	ASD, g ² /Hz
5	0.015
40	0.015
120	0.002025
121	0.003
200	0.003
240	0.0015
266	0.000475
500	0.00015
rms = 1.17 g	

MIL-STD-810H
METHOD 514.8, ANNEX C

b. Two-wheeled trailer and wheeled vehicles.

Both trucks and two-wheeled trailers are used between the Forward Supply Point (FSP) and at the Using Unit (USU). When materiel is too large for the two-wheeled trailer, use the composite wheeled levels.

- (1) **Two wheeled trailer (TWT).** Exposures are shown in Figure 514.8C-4, and are followed by the respective data table (Table 514.8C-IV). If the orientation of the test item is unknown or variable see Figure 514.8C-5 and Table 514.8C-V for exposure levels. (See paragraph 6.1, references pp to vv.)

Test Schedule: Secured Cargo – Two-Wheeled Trailer

Vehicles Used for Composite: Measured vibration data from the following vehicles (Table 514.8C-III) were used to develop the Two-Wheeled Trailer Vehicle test schedule:

Table 514.8C-III. Vehicles used for TWT composite.

NOMENCLATURE	DESCRIPTION
M105A2	U.S. 1-1/2 ton trailer
N/A	German 1-1/2 ton trailer
M1102	U.S. 1-1/4 ton trailer

Measured Locations: 9 locations on frame under cargo bed (3X3 matrix).

Type of Test Load: Sand filled ammo boxes (or other similar cargo) were secured to the cargo bed, and loaded to ¾ of vehicle rated load.

Scenario to be Simulated: 51.5 km (32 mi) from the forward supply point to the using unit described as follows: The typical mission/field transport scenario starts at the port staging area (PSA). The movement prior to this point would include transport by commercial common carrier, military long-range aircraft, ship, and/or railroad. This movement would occur over improved road surfaces or in platforms that have been proven to impose significantly lower vibration levels than those vehicles used for transport from the port staging area to the using unit. The typical scenario has established that 51.5 km (32 mi) of transport are expected between forward supply point to the using unit. This transport is in two-wheeled trailers. The road surfaces will be paved, secondary, and cross-country.

Assumptions (Scenario, Load, Failure Mechanism, etc.):

Total Mission of 51.5 km (32 miles) is accounted for as follows:

- 15 percent of total mission, 7.7 km (5 miles), is on-road and considered benign compared to the off-road environment.
- 85 percent of total mission, 43.8 km (27 miles), is off-road:
 - One-third of the off-road environment, 14.6 km (9 miles), is rough terrain consistent with the Belgian Block, Two-Inch Washboard, Radial Washboard, and Three-Inch Space Bump courses used to collect data. Average Speed over these courses was 26 km/hr (16 mph).
 - Two-thirds of the off-road environment, 29.2 km (18 miles), is considered benign compared to the test conditions described above.

Failure mode: fatigue

Test Time Compression: None; this test is run in real time.

Test Time: 32 minutes per axis

Exaggeration Factor: 1.00

MIL-STD-810H
METHOD 514.8, ANNEX C

Method of Combination of Spectra: A statistical method as described in Annex F, Appendix C, was used to create the spectra for the individual trailers in Table 514.8C-III. This method makes use of the spectral variance from different measurement locations and test conditions and produces a spectrum that is a very conservative estimate of the actual measured environments. This procedure produced an ASD for each trailer in each of the orthogonal axes. The composite two-wheeled trailer spectrum was created by enveloping the individual trailers. Ideally a statistical method would have been used (as was done for the Composite Wheeled Vehicle below) but because the number of samples was so low an enveloping method was employed.

Location of Control Accelerometer(s): 2 accelerometers at opposite corners, within 30 cm (12 in.) from test item

Recommended Control Scheme: Average (Extremal control may be appropriate for some applications). Based on the field data characteristics and the conservatism associated with the composite vehicle VSD process, drive limiting to 3 sigma is recommended.

For movement direction definitions, see paragraph 4.4 in the front part of this Method.

RMS Acceleration:^{1,3} (G-rms): Vertical – 3.98;

Transverse – 1.22;

Longitudinal – 2.52;

Envelope – 4.03.

Velocity (in/sec) (peak single amplitude):^{1,3}

Vertical – 33.29;

Transverse – 15.23;

Longitudinal – 18.18;

Envelope – 33.30.

Displacement (in) (peak double amplitude):^{1,2,3}

Vertical – 1.51;

Transverse – 0.69;

Longitudinal – 0.79;

Envelope – 1.51.

¹ Approximate values for a Gaussian random distribution which may vary based on the control system and spectral resolution. Peak velocity and displacement values are based on an acceleration maximum of three times the standard deviation (3σ) and a spectral resolution of 1 Hz.

² For shaker systems that are incapable of the displacement requirements of this schedule, minor adjustments may be made to the low frequency within the tolerances specified in 4.2.2.1a (main body) to accommodate the shaker limitations. If any schedule needs to be modified, make sure that all parties involved (tester, customer, etc.) are aware of the reason for the changes, and agree to the changes prior to test. Ensure an adequate test is performed and all deviations from the published schedules are properly documented.

³ For test items for which the test item orientation is unknown or variable the Envelope profile should be run for all three axes (Figure 514.8C-5 and Table 514.8C-V).

MIL-STD-810H
METHOD 514.8, ANNEX C

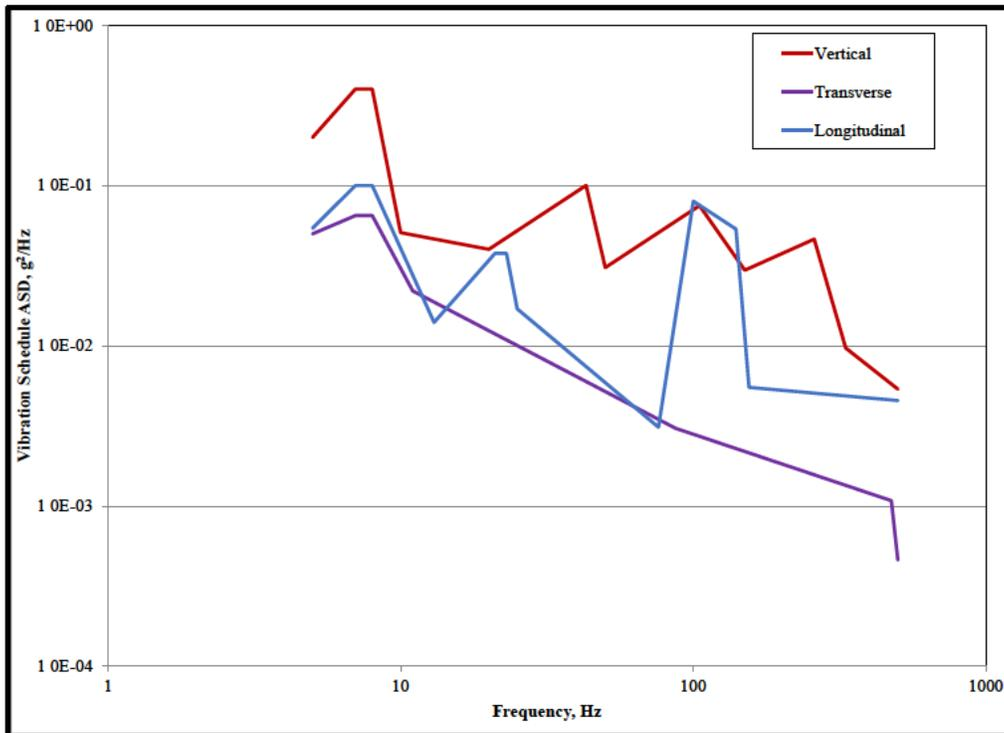


Figure 514.8C-4. – Category 4 – Composite two-wheeled trailer vibration exposure.

Table 514.8C-IV. Category 4 – Composite two-wheeled trailer vibration exposure. (Break points for curves of Figure 514.8C-4.)

Vertical		Transverse		Longitudinal	
Frequency, Hz	ASD, g²/Hz	Frequency, Hz	ASD, g²/Hz	Frequency, Hz	ASD, g²/Hz
5	0.20000	5	0.05000	5	0.05418
7	0.40000	7	0.06500	7	0.10000
8	0.40000	8	0.06500	8	0.10000
10	0.05090	11	0.02200	13	0.01400
20	0.04000	87	0.00306	21	0.03780
43	0.10036	475	0.00108	23	0.03780
50	0.03079	500	0.00046	25	0.01700
105	0.07500			76	0.00310
150	0.02964			100	0.08000
259	0.04636			140	0.05354
332	0.00970			155	0.00551
500	0.00537			500	0.00456
rms = 3.98 g		rms = 1.22 g		rms = 2.52 g	

MIL-STD-810H
METHOD 514.8, ANNEX C

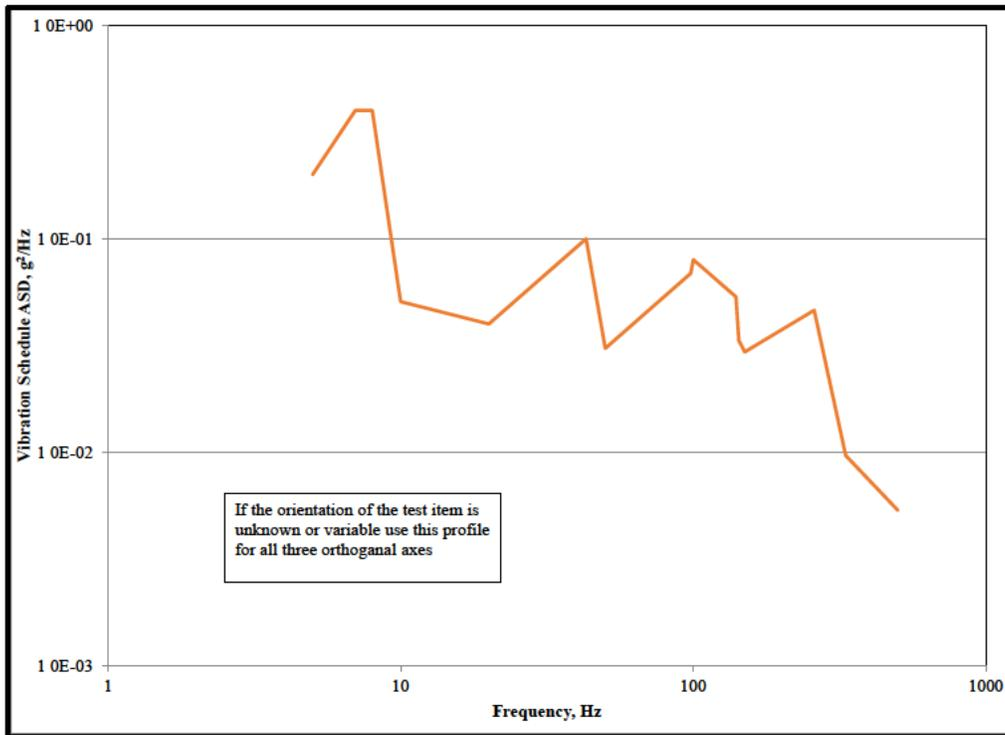


Figure 514.8C-5. – Category 4 – Composite two-wheeled trailer vibration exposure for unknown orientation.

Table 514.8C-V. Category 4 – Composite two-wheeled trailer vibration exposure for unknown orientation.
(Break points for curves of Figure 514.8C-5.)

V, L&T Envelope	
Frequency, Hz	ASD, g ² /Hz
5	0.20000
7	0.40000
8	0.40000
10	0.05090
20	0.04000
43	0.10036
50	0.03079
98	0.06910
100	0.08000
140	0.05354
143	0.03350
150	0.02964
259	0.04636
332	0.00970
500	0.00537
rms = 4.03 g	

MIL-STD-810H
METHOD 514.8, ANNEX C

- (2) **Composite wheeled vehicle (CWV)**. Exposures are shown in Figure 514.8C-6, and are followed by the respective data table (Table 514.8C-VII). If the orientation of the test item is unknown or variable, see exposure levels shown in Figure 514.8C-7 and Table 514.8C-VIII. (See paragraph 6.1, references pp to vv.)

Test Schedule: Secured Cargo – Composite Wheeled Vehicle

Vehicles Used for Composite: Measured vibration data from the following vehicles (Table 514.8C-VI) were used to develop the Composite Wheeled Vehicle test schedule:

Table 514.8C-VI. Vehicles used for CWV composite.

NOMENCLATURE	DESCRIPTION
M985	US Heavy Expanded Mobility Tactical Truck (HEMTT) 10-ton truck
MK27*	US Medium Tactical Vehicle Replacement (MTVR) 7-ton truck
M1083/M1084/M1085	US Medium Tactical Vehicle (MTV) 5-ton truck
M1151**/M1152/M1113	US High Mobility Multipurpose Wheeled Vehicle (HMMWV) 1-1/4-ton truck
M1074/M1075	US Palletized Loading System (PLS) truck
M1078***	US Light MTV 2-1/2-ton truck
MTVR-T*	US MTVR trailer
M989****	US Heavy Expanded Mobility Trailer (HEMAT)
M1076	US PLS trailer
M1095	US MTV 5-ton trailer
M1082***	US Light MTV 2-1/2-ton trailer
M871A3*****	US 22-ton semitrailer
Unimog	German 2-ton truck
Machine Fabrik Augsburg Nurnberg (MAN)	German 5-, 7-, 10-, 15-ton trucks

* 2 measurement locations

** 6 measurement locations

*** 8 measurement locations

**** 4 measurement locations

***** 12 measurement locations

Measured Locations: 9 locations on frame under cargo bed (3X3 matrix) except as noted in the table above

Type of Test Load: Sand filled ammo boxes (or other similar cargo) were secured to the cargo bed, and loaded to ¾ of vehicle rated load.

Scenario to be Simulated: 805 km (500 mi) from the port staging area to the forward supply point described as follows: The typical mission/field transport scenario starts at the port staging area (PSA). The movement prior to this point would include transport by commercial common carrier, military long range aircraft, ship, and/or railroad. This movement would occur over improved road surfaces or in platforms that have been proven to impose significantly lower vibration levels than those vehicles used for transport from the port staging area to the using unit. The typical scenario has established that 805 km of transport are expected between the PSA and the forward supply point (FSP). This transport is in trucks and/or semitrailers. The road surfaces will be paved, secondary, and cross country.

MIL-STD-810H
METHOD 514.8, ANNEX C

Assumptions (Scenario, Load, Failure Mechanism, etc.):

Total Mission of 805 km (500 miles) is accounted for as follows:

- 35 percent of total mission, 282 km (175 miles), is on-road and considered benign compared to the off-road environment.
- 65 percent of total mission, 523 km (325 miles), is off-road:
 - One-third of the off-road environment, 174 km (108 miles), is rough terrain consistent with the Belgian Block, Two-Inch Washboard, Radial Washboard, and Three-Inch Spaced Bump courses used to collect data. Average Speed over these courses was 26 km/hr (16 mph).
 - Two-thirds of the off-road environment, 349 km (217 miles), is considered benign compared to the test conditions described above.

Failure mode: fatigue

Test Time Compression: Test time was computed from:

$$\frac{t_2}{t_1} = \left[\frac{W(f)_1}{W(f)_2} \right]^{m/2}$$

Where:	t_1	=	equivalent test time
	t_2	=	in-service time for specified condition
	$W(f)_1$	=	ASD at test condition, g²/Hz
	$W(f)_2$	=	ASD at in-service condition, g²/Hz
	m	=	7.5 (see paragraph 2.2 of Annex A for further explanation)

Test Time: 40 minutes per axis

Exaggeration Factor: $\left[\frac{W(f)_1}{W(f)_2} \right] = 1.85$

Method of Combination of Spectra: A statistical method, as described in Annex F, Appendix C, was used to create the spectra for the individual vehicles in Table 514.8C-VI. This method makes use of the spectral variance from different measurement locations and test conditions and produces a spectrum that is a very conservative estimate of the actual measured environments. This procedure produced an ASD for each vehicle in each of the orthogonal axes. The composite wheeled vehicle spectrum was created by applying the upper normal one-sided tolerance limit to the spectrum data. The upper normal one-sided tolerance limit is based on two values, β and γ . For these data β was set to 0.90 and γ was set to 0.50. This means that one is 50 percent confident that 90 percent of the vibration profiles of all wheeled cargo vehicles will fall below the composite wheeled vehicle vibration schedules presented below. The upper normal one-sided tolerance limit is described more fully in Annex F, Appendix B, paragraph 2.3.

Location of Control Accelerometer(s): 2 accelerometers at opposite corners, within 30 cm (12 in.) from test item

Recommended Control Scheme: Average (Extremal control may be appropriate for some applications). Based on the field data characteristics and the conservatism associated with the composite vehicle VSD process, drive limiting to 3 sigma is recommended.

For movement direction definitions, see paragraph 4.4 in the front part of this Method.

MIL-STD-810H
METHOD 514.8, ANNEX C

RMS Acceleration:^{1,3} (G-rms): Vertical – 2.24;
Transverse – 1.45;
Longitudinal – 1.32;
Envelope – 2.24.

Velocity (in/sec) (peak single amplitude):^{1,3}
Vertical – 28.76;
Transverse – 17.83;
Longitudinal – 12.75;
Envelope – 28.76.

Displacement (in) (peak double amplitude):^{1,2,3}
Vertical – 1.22;
Transverse – 0.73;
Longitudinal – 0.51;
Envelope – 1.22.

¹ Approximate values for a Gaussian random distribution which may vary based on the control system and spectral resolution. Peak velocity and displacement values are based on an acceleration maximum of three times the standard deviation (3σ) and a spectral resolution of 1 Hz.

² For shaker systems that are incapable of the displacement requirements of this schedule, minor adjustments may be made to the low frequency ASD values within the tolerances specified in 4.2.2.1a (main body) to accommodate the shaker limitations. If any schedule needs to be modified, make sure that all parties involved (tester, customer, etc.) are aware of the reason for the changes, and agree to the changes prior to test. Ensure an adequate test is performed and all deviations from the published schedules are properly documented.

³ For test items for which the test item orientation is unknown or variable the Envelope profile should be run for all three axes (Figure 514.8C-7 and Table 514.8C-VIII).

MIL-STD-810H
METHOD 514.8, ANNEX C

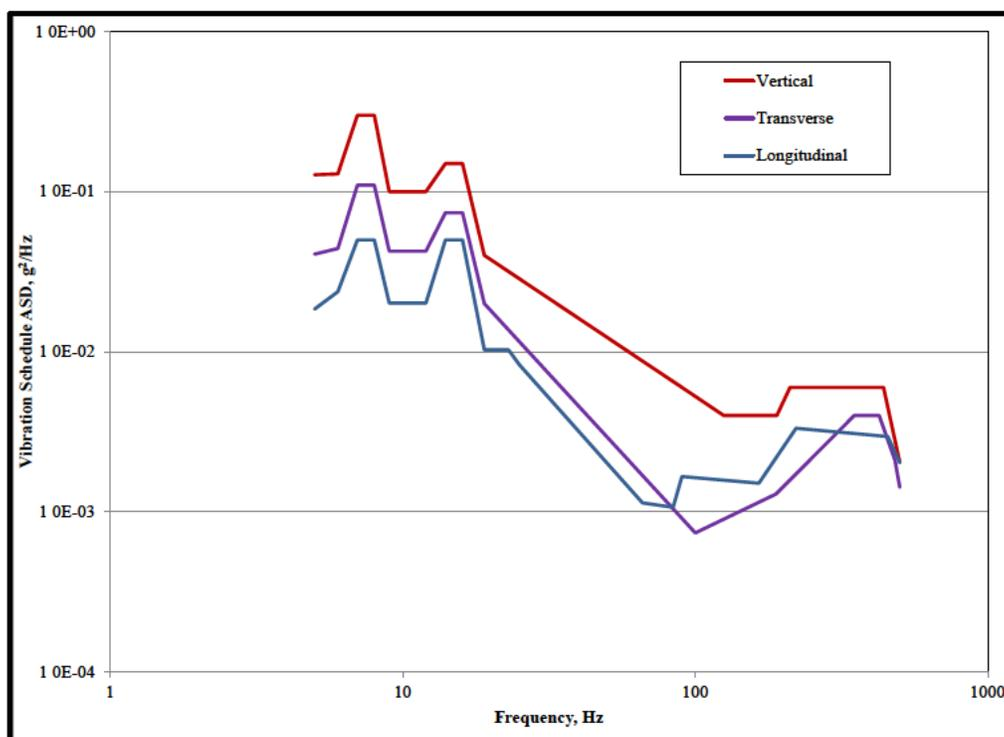


Figure 514.8C-6. – Category 4 – Composite wheeled vehicle vibration exposure.

Table 514.8C-VII. Category – 4 – Composite wheeled vehicle vibration exposure. (Break points for curves of Figure 514.8C-6.)

Vertical		Transverse		Longitudinal	
Frequency, Hz	ASD, g ² /Hz	Frequency, Hz	ASD, g ² /Hz	Frequency, Hz	ASD, g ² /Hz
5	0.12765	5	0.04070	5	0.01848
6	0.12926	6	0.04415	6	0.02373
7	0.30000	7	0.11000	7	0.05000
8	0.30000	8	0.11000	8	0.05000
9	0.10000	9	0.04250	9	0.02016
12	0.10000	12	0.04250	12	0.02016
14	0.15000	14	0.07400	14	0.05000
16	0.15000	16	0.07400	16	0.05000
19	0.04000	19	0.02000	19	0.01030
90	0.00600	100	0.00074	23	0.01030
125	0.00400	189	0.00130	25	0.00833
190	0.00400	350	0.00400	66	0.00114
211	0.00600	425	0.00400	84	0.00107
440	0.00600	482	0.00210	90	0.00167
500	0.00204	500	0.00142	165	0.00151
				221	0.00333
				455	0.00296
				500	0.00204
rms = 2.24 g		rms = 1.45 g		rms = 1.32 g	

MIL-STD-810H
METHOD 514.8, ANNEX C

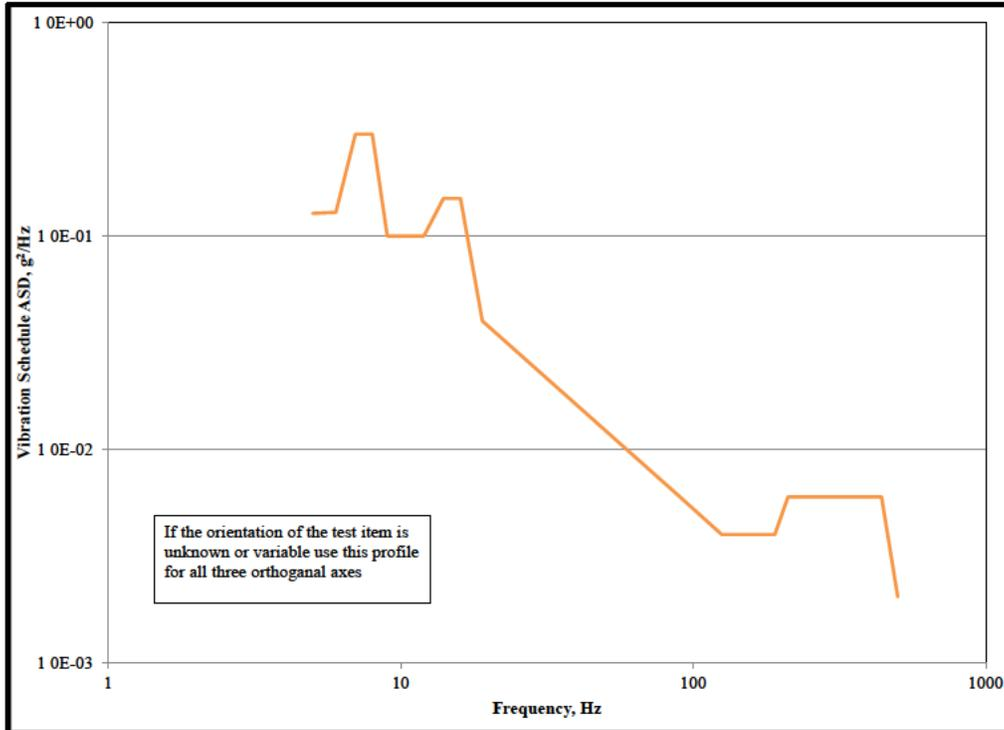


Figure 514.8C-7. – Category 4 – Composite wheeled vehicle vibration exposure for unknown orientation.

Table 514.8C-VIII. Category – 4 – Composite wheeled vehicle vibration exposure for unknown orientation.
(Break points for curves of Figure 514.8C-7.)

Envelope	
Frequency, Hz	ASD, g ² /Hz
5	0.12765
6	0.12926
7	0.30000
8	0.30000
9	0.10000
12	0.10000
14	0.15000
16	0.15000
19	0.04000
90	0.00600
125	0.00400
190	0.00400
211	0.00600
440	0.00600
500	0.00204
rms = 2.24 g	

MIL-STD-810H
METHOD 514.8, ANNEX C

2.1.4 Exposure durations. Base durations on the materiel Life Cycle Environment Profile. Figure 514.8C-1 shows the typical field/mission transportation scenario with the most typical vehicles.

- a. Truck transportation over US highways. The exposure duration for common carrier/truck is 60 minutes per 1609 kilometers (1000 miles) of road travel (per axis).
- b. Two-wheeled trailer and wheeled vehicles. The exposure duration for two-wheeled trailer is 32 minutes per 51.5 kilometers (32 miles) traveled (per axis), and the exposure duration for composite wheeled vehicles is 40 minutes per 805 kilometers (500 miles) traveled (per axis).

2.2 Category 5 - Truck/trailer - loose cargo.

The cargo has freedom to bounce, scuff and collide with other cargo and with the sides of the vehicle. The loose cargo environment includes conditions experienced by cargo transported in a vehicle traversing irregular surfaces. This test replicates the repetitive random shock environment incurred by cargo transported under these conditions. This test does not address general cargo deck vibration or individual shocks or impacts inflicted during handling or accidents.

- a. Test bed. (See Figure 514.8C-8.) Cover the test bed of the package tester with a cold rolled steel plate (see note below), 5 to 10 mm (0.2 to 0.4 in) thick, and secure the plate with bolts. The tops of the heads should be slightly below the surface. Space the bolts at sufficient intervals around the four edges and through the center area to prevent diaphragming of the steel plate. Do not start a test on an area of steel plate that is severely damaged or worn through.

Note: Comparison of plywood bed and steel bed data show no statistical difference. Also, steel beds require less maintenance and US Army trucks use steel beds. See paragraph 6.1, reference a.

- b. Fencing. Two different setups of fencing are required depending on the type of test item. The two types are those that are more likely to slide on the test surface or “rectangular cross section items” (typically packaged items), and those most likely to roll on the surface, or “circular cross section items.” (“Multiple test items” refers to identical test items, and not to a mixture of unrelated test items.) The fence opposite the vertical impact wall is not intended as an impact surface, but is used to restrain the test item from leaving the tester. The distance to this restraining fence should be sufficient to prevent constant impact, but still prevent one or more of multiple test items from “walking” away from the others. The height of the test enclosure (sideboards, impact wall, and restraining fence) should be at least 5 cm higher than the height of the test item to prevent unrealistic impacting of the test item on the top of the enclosure.
- c. Test item structure.
 - (1) Materiel likely to slide (e.g., flat-bottomed). Using suitable fixturing as described previously, the test item is placed on the test machine. The wooden impact walls are configured so as to allow impacting on only one end wall (no rebounding), and to prevent unlimited rotation of test items that are non-symmetrical about the vertical axis. Multiple test items are not separated from one another by sideboards. The test item is positioned in its most likely transport orientation. In the event the most likely transport orientation cannot be determined, the test item is placed on the bed with the longest axis horizontal and parallel to the plane of rotation of the bed. The default space around the perimeter of a test item or an item and a barrier wall is a minimum of one inch (25.4 cm) at the start of testing. The spacing varies during testing and is not controlled. After one-half the total designated test time, stop the test, reposition the test item to an alternate orientation, and continue the test.
 - (2) Materiel likely to roll (e.g., circular cross section). For the circular cross section items, place the impact walls and sideboards so as to form a square test area. The size of the test area is determined by a series of equations presented below. S_W and S_B are chosen based on test item geometry to provide realistic impacting with the test bed impact walls and between test items. A typical value for both S_W and S_B is 25 mm. Use the following formulae to determine the test area dimension:

MIL-STD-810H
METHOD 514.8, ANNEX C

For values of the number of test items, $N > 3$, compute the required slenderness ratio, R_r , from Equation (1):

$$R_r = \frac{N L}{0.767 L \sqrt{N} - 2 S_W - (N-1) S_B} \quad \text{Equation (1)}$$

R_r = required slenderness ratio

L = length of the test item, cm

D = diameter of the test item, cm

N = number of test items

S_W = space between test item and wall, cm

S_B = space between each test item, cm

Compute the test item actual slenderness ratio, R_a , from:

$$R_a = L/D \quad \text{Equation (2)}$$

and it is independent of the number of test items, N .

If the actual test item slenderness ratio, R_a , is greater than the required ratio, R_r , computed in Equation (1), then:

$$X = 0.767 L \sqrt{N} \quad \text{Equation (3)}$$

X = length of each side of the square test area

If the actual test item slenderness ratio, R_a , is less than the required ratio, R_r , computed in Equation (1), then:

$$X = ND + 2S_W + (N-1)S_B \quad \text{Equation (4)}$$

For values of $N \leq 3$, the required slenderness ratio, R_r , is computed from Equation (5):

$$R_r = \frac{N L}{1.5 L - 2 S_W - (N-1) S_B} \quad \text{Equation (5)}$$

If the actual test item slenderness ratio, R_a , is greater than the required ratio, R_r , computed in Equation (5), then:

$$X \geq 1.5 L \quad \text{Equation (6)}$$

Otherwise:

X is computed from Equation (3).

Generally, if the actual slenderness ratio, L/D , is greater than 4, Equations (3) or (6), (depending upon the number of test items) are applicable.

- d. **Test item placement.** For either type test item, the materiel is placed on the test machine in a non-uniform manner. Because part of the damage incurred during testing of these rolling items is due to them impacting with each other, the number of test items should be greater than three. After the designated test time, stop the test.
- e. **Exposure levels.** This environment is a function of package geometry and inertial properties, vehicle geometry, and the complex vibratory motion of the vehicle cargo bed. No database exists for input vibration to simulate this environment. However, the test discussed below will provide a generally conservative simulation of the environment.
 - (1) Two methodology studies (paragraph 6.1 references g and h) determined that Figure 514.8C-8 package test equipment, operated in circular synchronous mode, provides a reasonable loose cargo simulation.

MIL-STD-810H
METHOD 514.8, ANNEX C

The equipment motion required is a 2.54 cm (1.0 inch) diameter orbital path at 5 Hz (300 RPM, approximately 1.3 g). Test equipment should have the capability to maintain the speed at 300 ± 2 RPM. Tables operated near maximum load capacity or with an unbalanced test item(s) may require a larger RPM tolerance. The use of a package tester operating in non-synchronous, vertical linear motion, or a single axis vibration system, is not an acceptable substitute for the loose cargo test requirement.

- (2) This test is not tailorable and cannot be directly interpreted in terms of materiel design requirements.
- f. Exposure durations. A duration of 20 minutes represents 240 km (150 miles) of transportation (encompassing truck, two-wheeled trailer, and tracked vehicle), over the various road profiles found in the transport scenario from the Corps Staging Area to a Using Unit (see Figure 514.8C-1). Use ratio scenario times in the materiel Life Cycle Environment Profile to define exposure times.

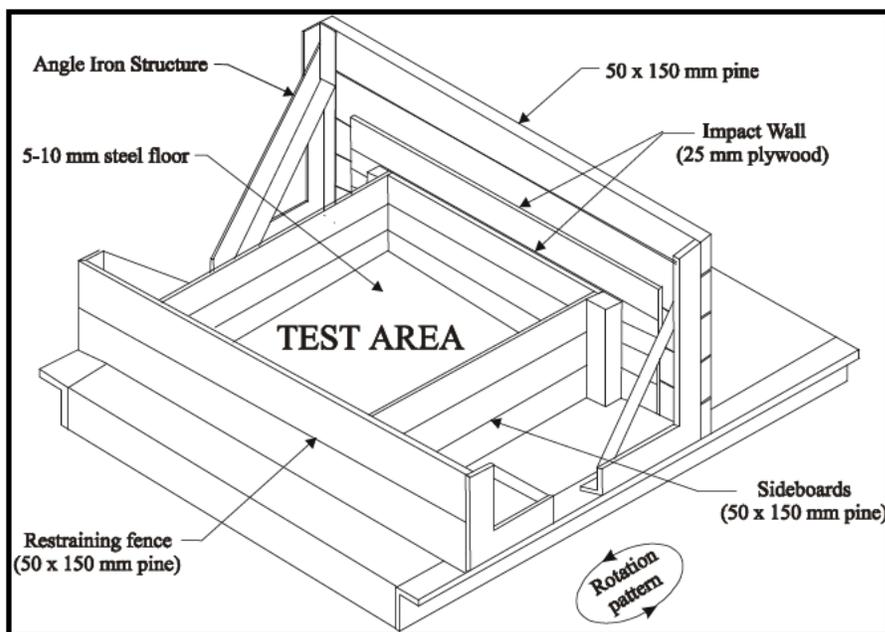


Figure 514.8C-8. Category 5 - Loose cargo test setup.

2.3 Category 6 - Truck/trailer - large assembly transport.

For large materiel, it is necessary to recognize that the materiel and the transport vehicle vibrate as a flexible system (see Annex A, paragraph 2.4). In such cases, transportation conditions may be simulated using the actual transport vehicle as the vibration exciter. The test assemblage may consist of materiel mounted in a truck or trailer, or materiel mounted in a shelter that is then mounted on a truck, trailer, or dolly set. Ensure the materiel is mounted and secured on the transport vehicle(s) that is used during actual transport. Provide instrumentation to measure vertical vibration of the materiel mounts, cargo floor, or shelter floor. Provide additional instrumentation as needed to determine the vibration of the materiel and critical subassemblies.

Note: This procedure is suitable for measuring or testing for the transportation or ground mobile environment of materiel of any size or weight. For smaller cargo loads, the assemblage should be either the specific design cargo load or the most critical cargo load(s) for the transport vehicle as appropriate.

- a. Exposure levels. The assemblage should be in its deployment configuration and mounted on the vehicle for which it was designed. If the assemblage is to be contained in a shelter, it should be installed within the shelter in the deployment configuration. The exposure consists of traversing the transport vehicle over a prepared test course. The test course and vehicle speeds should represent the transportation terrain/road conditions of the LCEP. Transport vehicle speeds may be limited either by the vehicle's safe operating speed over a specific course profile, or by the speed limit set for the specific course. An example based on test surfaces available at the US Army Aberdeen Test Center (paragraph 6.1, reference b) is as follows. Drive the test vehicle over each of the following test surfaces. Operate at the specified speeds unless these exceed safe driving conditions. In this case, define and coordinate maximum safe operating speeds with

MIL-STD-810H
METHOD 514.8, ANNEX C

the authority responsible for the environmental requirements.

	Vehicle Speed		Course Length	
	km/hr	(mph)	m	(ft)
(1) Coarse washboard [150 mm (6 in) waves; 1.8 m (6 ft) apart]	8	(5)	243	(798)
(2) Belgian block	32	(20)	1201	(3940)
(3) Radial washboard [50 mm (2 in) to 100 mm (4 in) waves]	24	(15)	74	(243)
(4) Two inch washboard [50 mm (2 in) waves, 0.6 m (2 ft) apart]	16	(10)	251	(822)
(5) Three inch spaced bump [75 mm (3 in) bumps]	32	(20)	233	(764)

- b. Exposure durations. Ensure the durations (distances) of each test course segment/speed combination are in accordance with the scenario(s) of the Life Cycle Environment Profile. If the LCEP in-service road information is not available, the minimum test duration is defined by operation of the vehicle five individual times on the full length of each test course above, or an equal total distance at the indicated or test plan defined speed(s).

2.4 Category 7 - Aircraft - jet.

Cargo vibration environments on jet aircraft are broadband random in nature. The maximum vibrations are usually engine exhaust noise generated and occur during takeoff. Levels drop off rapidly after takeoff to lower level cruise levels that are boundary layer noise generated. These sources are discussed in Annex D, paragraph 2.1.

- a. Low frequency vibration. Vibration criteria typically begin at 15 Hz. At frequencies below 15 Hz, it is assumed that the cargo does not respond dynamically (see Annex A, paragraph 2.4). Airframe low frequency vibration (gust response, landing impact, maneuvers, etc.) is experienced as steady inertial loads (acceleration). That part of the environment is included in Method 513.8.
- b. Large cargo items. Cargo items that are large relative to the airframe in dimensions and/or mass may interact with aircraft structural dynamics (see Annex A, paragraph 2.4). This is particularly true if the materiel has natural frequencies below 20 Hz. This interaction may have serious consequences with regard to aircraft loads and flutter. Evaluate materiel that fits this description by the aircraft structural engineers prior to carriage. Contact the Aircraft Product Center Wings responsible for the aircraft type for this evaluation.
- c. Exposure levels.
- (1) Vibration qualification criteria for most jet cargo airplanes are available through the Aircraft Product Center Wings responsible for the aircraft type. These criteria are intended to qualify materiel for permanent installation on the airplanes and are conservative for cargo. However, function criteria for materiel located in the cargo deck zones can be used for cargo if necessary. The guidance of Annex D, paragraph 2.1 can also be used to generate conservative criteria for specific airplanes and cargo. The associated spectral shape and functional guidance from Annex D are repeated below for convenience as Figure 514.8C-10 and Table 514.8C-X.
 - (2) Figure 514.8C-9 shows the cargo compartment zone functional qualification levels of the C-5, C/KC-135, C-17, E/KE-3, KC-10, and T-43A aircraft. These are recommended criteria for jet aircraft cargo. Also, shown on the figure is a curve labeled "General Exposure." This curve is based on the worst case zone requirements of the most common military jet transports, so that even though it does not envelope all peaks in the various spectra, it should still be mildly conservative for cargo. Also, since it does not allow the valleys in the individual spectra, it should cover other jet transports with different frequency characteristics. The envelope represents take-off, the worst case for cargo. Vibration during other flight conditions is substantially less.
- d. Exposure durations. When Figure 514.8C-9 is used, select a duration of one minute per takeoff. Determine the number of takeoffs from the LCEP.

MIL-STD-810H
METHOD 514.8, ANNEX C

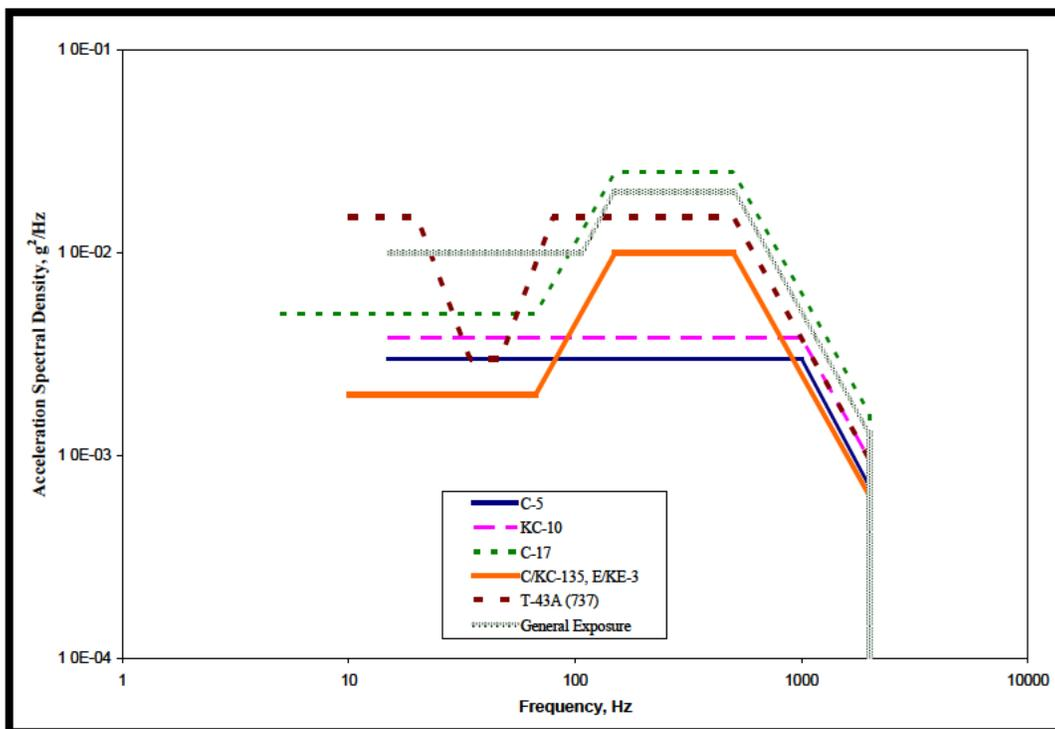


Figure 514.8C-9. Category 7 - Jet aircraft cargo vibration exposure.

Table 514.8C-IX. Category 7 - Jet aircraft cargo vibration exposure - Break points for Figure 514.8C-9.

C-5			KC-10			KC-135, E-3			C-17		
Hz	g ² /Hz	dB/Oct	Hz	g ² /Hz	dB/Oct	Hz	g ² /Hz	dB/Oct	Hz	g ² /Hz	dB/Oct
15	0.003		15	0.0038		10	0.002		5	0.005	
1000	0.003		1000	0.0038		67	0.002		67	0.005	
		-6			-6			6			6
2000	7.5E-4		2000	9.5E-4		150	0.01		150	0.025	
rms = 2.11 g			rms = 2.38 g			500	0.01		500	0.025	
								-6			-6
						2000	6.3E-4		2000	1.6E-3	
						rms = 2.80 g			rms = 4.43 g		
T-43A (737)			General Exposure			Note: C-17 levels apply to the primary cargo floor. Levels for items carried on the aft ramp are higher.					
Hz	g ² /Hz	dB/Oct	Hz	g ² /Hz	dB/Oct						
10	0.015		15	0.01							
20	0.015		106	0.01							
		-9			6						
34	0.003		150	0.02							
47	0.003		500	0.02							
		9			-6						
80	0.015		2000	1.3E-3							
500	0.015		rms = 4.02 g								
		-6									
2000	9.5E-4										
rms = 3.54 g											

MIL-STD-810H
METHOD 514.8, ANNEX C

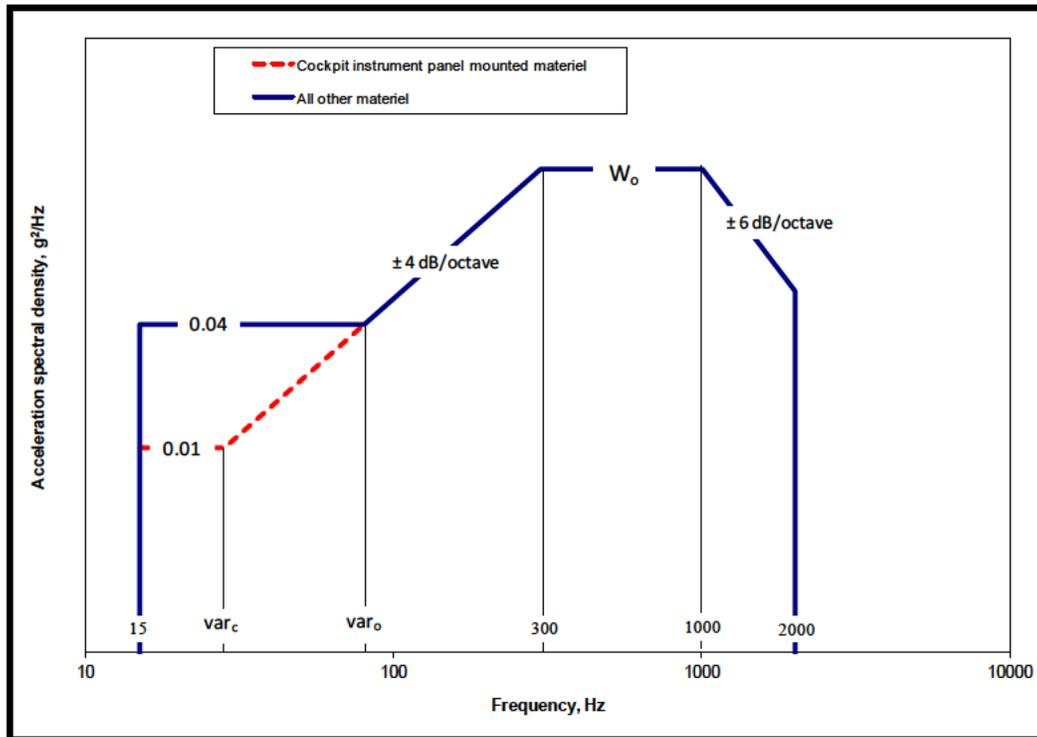


Figure 514.8C-10. Category 7 - Jet aircraft vibration exposure. (Same as Annex D, Figure 514.8D-1.)

MIL-STD-810H
METHOD 514.8, ANNEX C

Table 514.8C-X. Category 7 - Jet aircraft vibration exposure. (Same as Annex D, Table 514.8D-I.)

$W_0 = W_A + \sum_1^n (W_J)$	
W_0, W_A, W_J - Exposure levels in acceleration spectral density (g^2/Hz).	
Aerodynamically induced vibration $W_A = a \times b \times c \times (q)^2$	
Jet engine noise induced vibration $W_J = \{[0.48 \times a \times d \times \cos^2(\theta)/R] \times [D_c \times (V_c / V_r)^3 + D_f \times (V_f / V_r)^3]\}$	
a	- Platform/Materiel interaction factor (see Annex A, paragraph 2.4). Note that this factor applies to W_0 and not to the low frequency portion (15 Hz to break) of Figure 514.8C-10. = 1.0 for materiel mounted on vibration isolators (shock mounts) and materiel weighing less than 36.3 kg. = $1.0 \times 10^{(0.6 - W/60)}$ for materiel weighing between 36.3 and 72.6 kg. (w = weight in kg) = 0.25 for materiel weighing 72.6 kg or more.
b	- Proportionality factor between vibration level and dynamic pressure (SI units). \sum_1^n - Jet noise contribution is the sum of the W_J values for each engine. = 2.96×10^{-6} for materiel mounted on cockpit instrument panels. = 1.17×10^{-5} for cockpit materiel and materiel in compartments adjacent to external surfaces that are smooth and free from discontinuities. = 6.11×10^{-5} for materiel in compartments adjacent to or immediately aft of external surface discontinuities (cavities, chines, blade antennae, speed brakes, etc.), fuselage aft of wing trailing edge, wing, empennage, and pylons. d - Afterburner factor. = 1.0 for conditions where afterburner is not used or is not present. = 4.0 for conditions where afterburner is used. R - Vector distance from center of engine exhaust plane to materiel center of gravity, m (ft). θ - Angle between R vector and engine exhaust vector (aft along engine exhaust centerline), degrees For $70^\circ < \theta \leq 180^\circ$ use 70° .
c	= Mach number correction. Note that this factor applies to W_0 and not to the low frequency portion (15 Hz to var_c or var_o) of Figure 514.8C-10. = 1.0 for $0 \leq Mach \leq 0.9$ = $(-4.8M + 5.32)$ for $0.9 \leq Mach \leq 1.0$ (where M = Mach number) = 0.52 for Mach number greater than 1.0 D _c - Engine core exhaust diameter, m (ft). D _f - Engine fan exhaust diameter, m (ft). V _r - Reference exhaust velocity, m/sec (ft/sec). = 564 m/sec V _c - Engine core exhaust velocity (without afterburner), m/sec (ft/sec). V _f - Engine fan exhaust velocity (without afterburner), m/sec (ft/sec).
q	- Flight dynamic pressure, kN / m^2 (lb/ft ²). var_c - intersection frequency for cockpit materiel based on 4dB/oct slope from W_0 var_o - intersection frequency for all other materiel based on 4dB/oct slope from W_0 (See Annex A, para. 2.6.1 and Table 514.8D-V)
If Dimensions are in feet and pounds then:	
a	= 1.0 for materiel mounted on vibration isolators (shock mounts) and materiel weighing less than 80 lb. = $1.0 \times 10^{(0.60 - 0.0075 W)}$ for materiel weighing between 80 and 160 lb. = 0.25 for materiel weighing 160 lb. or more.
b	= 6.78×10^{-9} , 2.70×10^{-8} , or 1.40×10^{-7} in the order listed above.
V _r	= 1850 feet/second

MIL-STD-810H
METHOD 514.8, ANNEX C**2.5 Category 8 - Aircraft - propeller.**

Cargo vibration environments on propeller aircraft are dominated by relatively high amplitude, approximately sinusoidal spikes at propeller passage frequency and harmonics. There is wide band vibration at lower levels across the spectra. This wide band vibration is primarily due to boundary layer flow over the aircraft. These sources are discussed in Annex D, paragraph 2.2.

- a. Low frequency vibration. Vibration criteria typically begin at 10 Hz. At frequencies below 10 Hz it is assumed that the cargo does not respond dynamically (see Annex A, paragraph 2.4). Airframe low frequency vibration (gust response, landing impact, maneuvers, etc.) are experienced as steady inertial loads (acceleration). That part of the environment is included in Method 513.8.
- b. Large cargo items. Cargo items that are large relative to the airframe in dimensions and/or mass may interact with aircraft structural dynamics (see Annex A, paragraph 2.4). This is particularly true if the materiel has natural frequencies below 20 Hz. This interaction may have serious consequences with regard to aircraft loads and flutter. Materiel that fits this description must be evaluated by aircraft structural engineers prior to carriage. Contact the Aircraft Product Center Wing responsible for the aircraft type for this evaluation.
- c. Exposure levels. Whenever possible, use flight vibration measurements to develop vibration criteria. In the absence of flight measurements: use the spectra of Figure 514.8C-11 and Table 514.8C-XI for the 4-blade C-130; use the spectra of Figure 514.8C-12 and Table 514.8C-XII for the 6-blade C-130; and use the spectra of Figure 514.8C-13 and Table 514.8C-XIII for fixed wing propeller aircraft other than C-130. Zones for propeller aircraft are shown in Figure 514.8C-14. The C-130 spectra are based on measurements made on several versions of the C-130K (4 blade) and C-130J (6-blade) aircraft (paragraph 6.1, references yy and zz) and are fairly representative of the environments of these aircraft.
- d. Exposure durations. Take durations from the Life Cycle Environment Profile. If LCEP data are not available for development of test durations, tests should be conducted for one hour per axis which is equivalent to a 20 hour flight. There are two versions of the C-130 vibration profile, the first represents the 4-bladed version and the second represents the 6-bladed version. For cargo that will be transported in various version of the C-130 aircraft, split the durations evenly between the 4-bladed version and the 6-bladed version.
- e. Test Time Compression. For the C-130 spectra, test time was computed utilizing the guidance provided in Section 9.2.1.2 of Annex F with a slope (m) of 5.0.

MIL-STD-810H
METHOD 514.8, ANNEX C

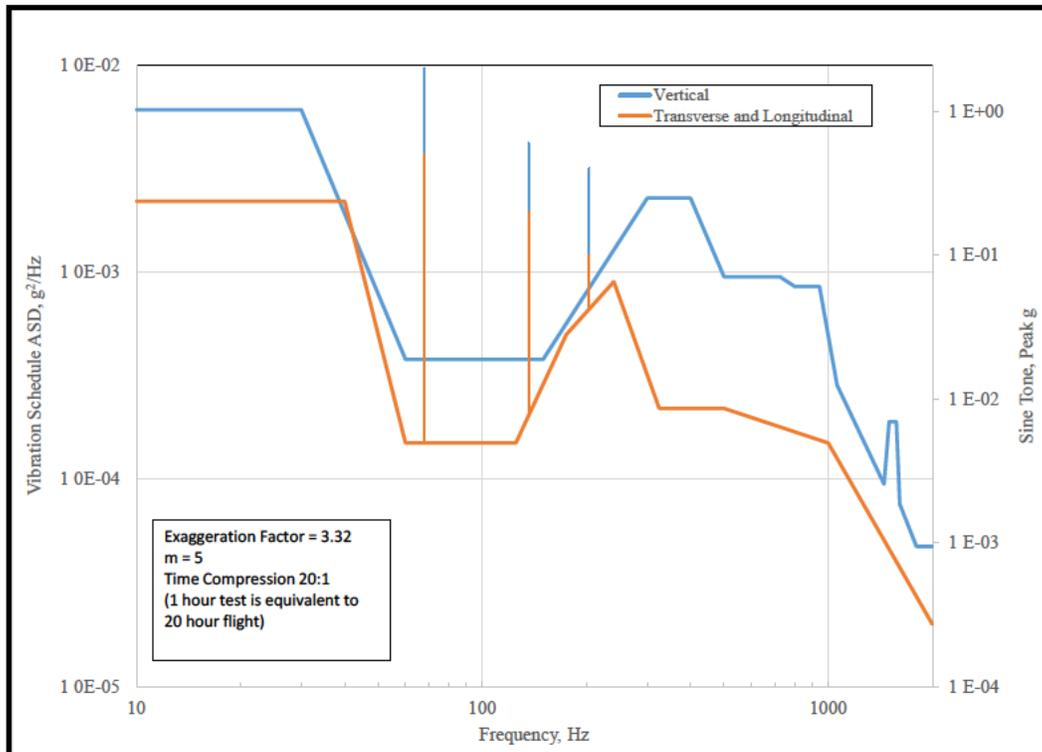


Figure 514.8C-11. Category 8 - Propeller aircraft vibration exposure, 4-bladed C-130.

Table 514.8C-XI. Category 8 - Propeller aircraft vibration exposure. 4-bladed C-130.

Vertical Axis Broadband Random		Vertical Axis Sinusoidal Components		Longitudinal and Transverse Broadband Random	
Frequency, Hz	ASD, g ² /Hz	Center Frequency, Hz (Blade Order)	Acceleration peak (g _{pk})	Frequency, Hz	ASD, g ² /Hz
10	0.0032	17 (R)	0.5	10	0.0022
30	0.0032	68 (nR)	2	40	0.0022
60	0.0002	136(2nR)	0.6	60	0.00015
150	0.0002	204 (3nR)	0.4	125	0.00015
300	0.0012	Overall rms, g	1.76	175	0.0005
400	0.0012	Longitudinal and Transverse Sinusoidal Components		240	0.0009
500	0.0005			325	0.00022
725	0.0005			500	0.00022
800	0.00045			1000	0.00015
943	0.00045			2000	0.00002
1061	0.00015	rms, g	0.61		
1450	0.00005	Center Frequency, Hz (Blade Order)	Acceleration peak (g _{pk})		
1500	0.0001				
1575	0.0001	17 (R)	0.2		
1610	0.00004	68 (nR)	0.5		
1800	0.000025	136 (2nR)	0.2		
2000	0.000025	204 (3nR)	0.1		
rms, g	0.84	Overall rms, g	0.74		

Test Duration per axis: 1 hour for 20 hours of flight.

MIL-STD-810H
METHOD 514.8, ANNEX C

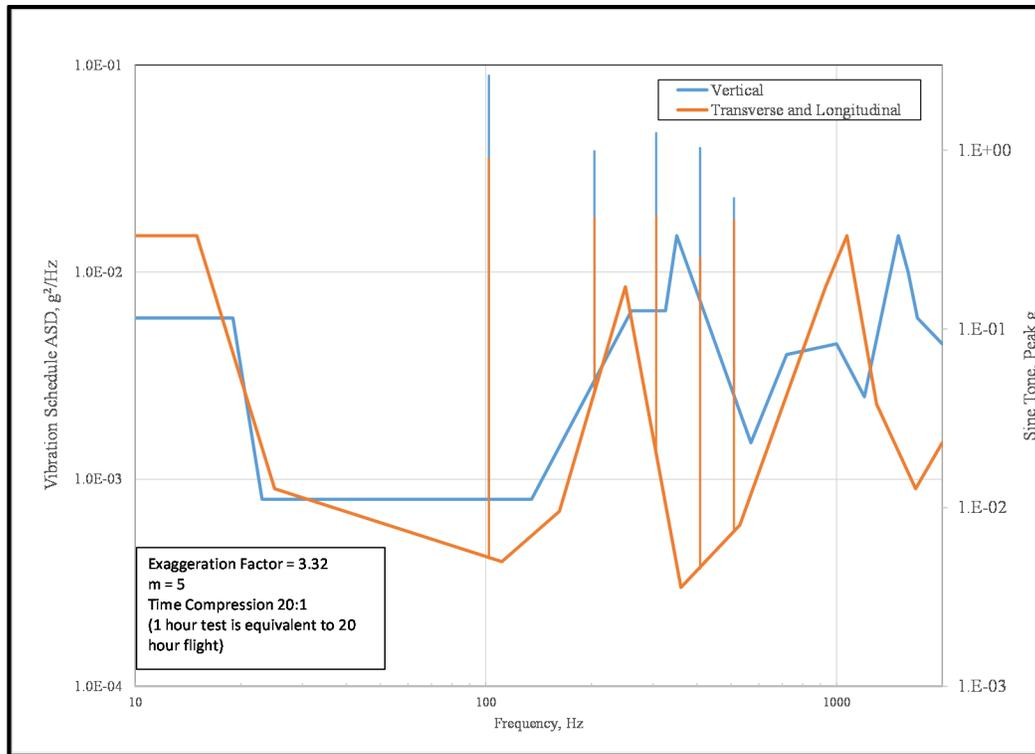


Figure 514.8C-12. Category 8 - Propeller aircraft vibration exposure. 6-bladed C-130

Table 514.8C-XII. Category 8 - Propeller aircraft vibration exposure. 6-bladed C-130.

Vertical Axis Broadband Random		Vertical Axis Sinusoidal Components		Longitudinal and Transverse Broadband Random	
Frequency, Hz	ASD, g ² /Hz	Center Frequency, Hz (Blade Order)	Acceleration peak (g _{pk})	Frequency, Hz	ASD, g ² /Hz
10	0.006	102 (nR)	2.62	10	0.015
19	0.006	204 (2nR)	0.99	15	0.015
23	0.0008	306 (3nR)	1.25	25	0.0009
135	0.0008	408 (4nR)	1.03	111	0.0004
260	0.0065	510 (5nR)	0.54	162	0.0007
325	0.0065	Overall rms, g	3.97	250	0.0085
350	0.015			360	0.0003
570	0.0015	Longitudinal and Transverse Sinusoidal Components		530	0.0006
720	0.004			930	0.0085
1000	0.0045			1070	0.015
1200	0.0025	Center Frequency, Hz (Blade Order)	Acceleration peak (g _{pk})	1300	0.0023
1500	0.015			1680	0.0009
1600	0.01	102 (nR)	0.9	2000	0.0015
1700	0.006	204 (2nR)	0.42	rms, g	2.49
2000	0.0045	306 (3nR)	0.43		
rms, g	3.22	408 (4nR)	0.25		
		510 (5nR)	0.41		
		Overall rms, g	2.63		

Test Duration per axis: 1 hour for 20 hours of flight.

MIL-STD-810H
METHOD 514.8, ANNEX C

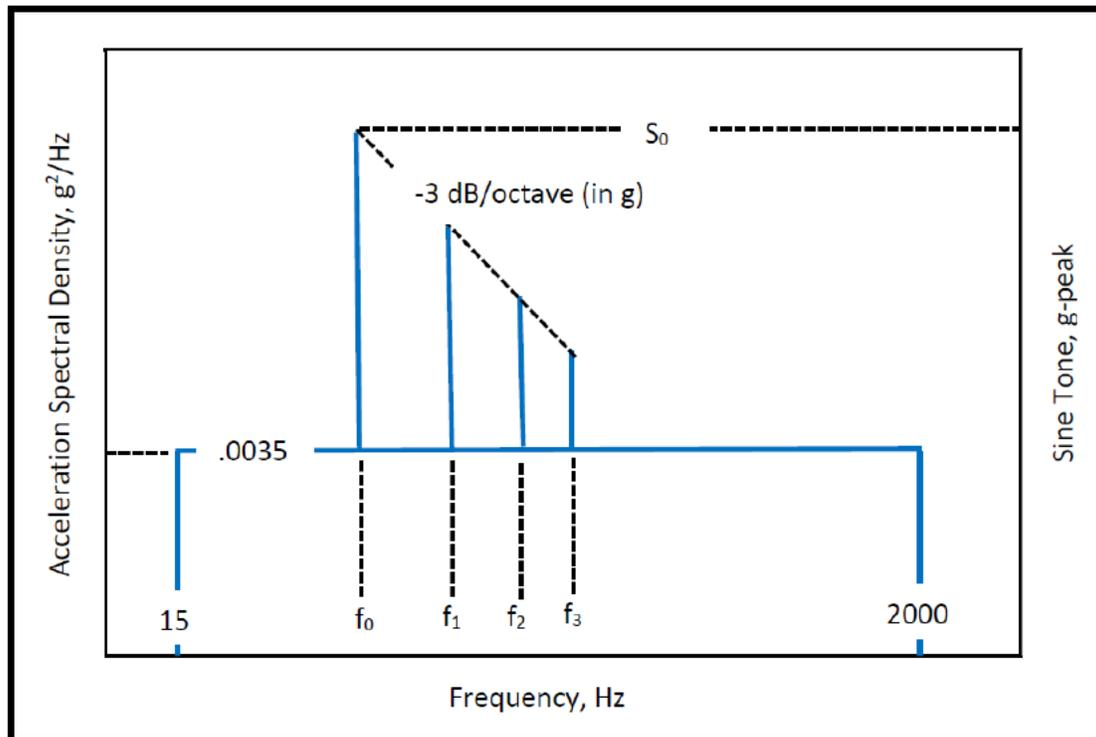


Figure 514.8C-13. Category 8 - Propeller aircraft vibration exposure. Other than C-130

Table 514.8C-XIII - Category 8 - Propeller aircraft vibration exposure. Other than C-130

TRANSPORTATION LOCATIONS (see Figure 514.8C-14)	NARROWBAND LEVEL L_0 (g^2/Hz)
In fuselage forward of propeller	0.035
In fuselage within one propeller blade radius of propeller passage plane	0.42
In fuselage or wing aft of propeller	0.11
<p>1/ f_0 = blade passage frequency (propeller rpm times number of blades) (Hz). $f_1 = 2 \times f_0$ $f_2 = 3 \times f_0$ $f_3 = 4 \times f_0$</p> <p>2/ Test should be conducted as sine-on-random, with:</p> $S_0 = 1.414 * \sqrt{0.1 * f_0 * L_0}$	
<p>3/ Sine tones may be swept to account for known variance in blade passing frequency.</p> <p>4/ If transportation location is unknown test to highest S_0 level of the possible locations.</p> <p>5/ Test duration per axis: 1 hour for 20 hours of flight.</p> <p>6/ The broadband and narrowband levels were derived from previous versions of this standard by decompression from 1000 to 20 flight hours per hour runtime utilizing Equation 9.5 of Annex F with $m = 7.5$ (slope for acceleration spectral density).</p>	

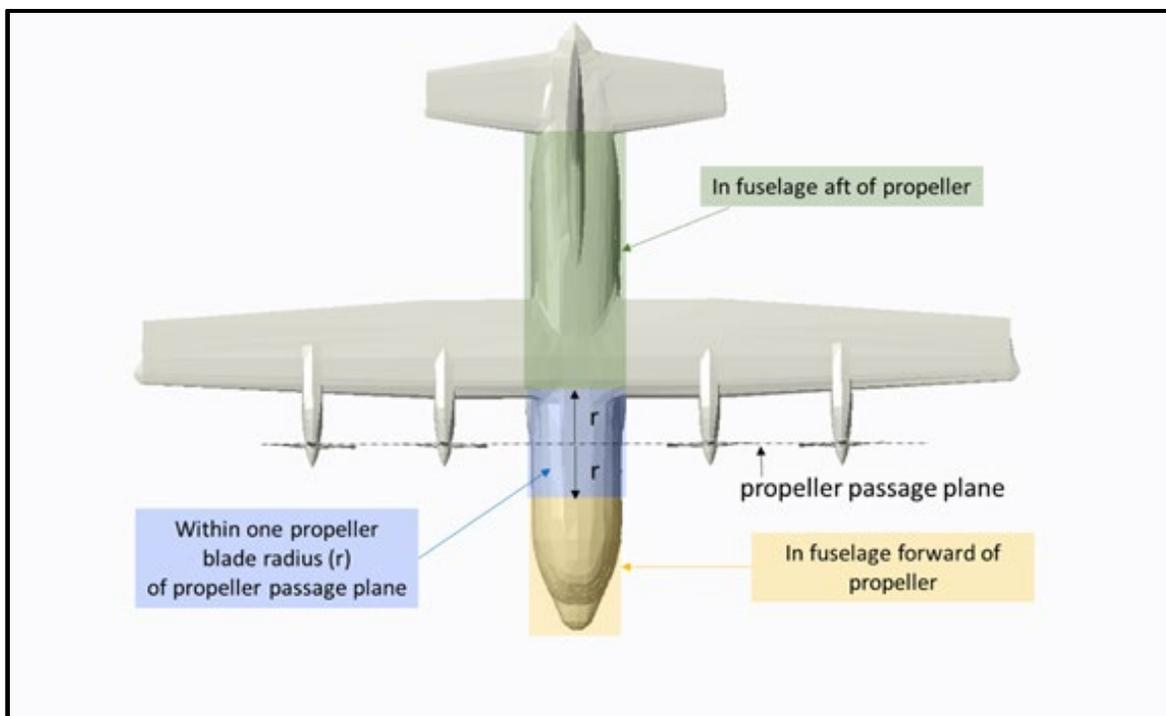
MIL-STD-810H
METHOD 514.8, ANNEX C

Figure 514.8C-14. Category 8 - Propeller aircraft transportation locations (other than C-130).

2.6 Category 9 - Aircraft - helicopter.

- a. Environment characterization. Vibration of cargo carried in helicopters is characterized by a continuous wideband, low-level background with strong narrowband peaks superimposed. This environment is a combination of many sinusoidal or near sinusoidal components due to main and tail rotors, rotating machinery and low-level random components due to aerodynamic flow. These sources are discussed in Annex D, paragraph 2.3.

Data acquired from variants of the rotorcraft listed in Table 514.8C-XIVa, were used to develop the random levels, source frequency relationships, and peak acceleration relationships reported in Table 514.8C-XIVb. Aircraft specific source frequencies are directly associated with rotor blade count and rotation speed. Tabulated source frequency ranges, peak acceleration amplitudes and associated random levels were empirically determined and encompass the vibration environments measured. The suitability of extrapolating these empirical peak acceleration relationships to aircraft not listed is unknown. Application of these empirical relationships to rotorcraft that are not included in the sample set should be applied with caution and only in the total absence of field data. Whenever possible, vehicle specific flight data should be acquired and employed in development of an aircraft specific vibration criterion.

- b. Sling loads. Cargo carried as sling loads below a helicopter is normally subjected to low level random vibration due to turbulent flow around the cargo with narrow band peaks due to helicopter main rotor blade passage. In addition, there will be low frequency (primarily vertical) motions due to the sling suspension modes (similar to vibration isolator modes, see Annex A, paragraph 2.4.2). Choose slings based on sling stiffness and suspended mass such that suspension frequencies (f_s) do not coincide with helicopter main rotor forcing frequencies (f_i). Ensure suspension frequencies are not within a factor of two of forcing frequencies ($f_s < f_i / 2$ or $f_s > 2 f_i$). Determine main rotor forcing frequencies (shaft rotation frequency, blade passage frequency, and harmonics) for several helicopters from Table 514.8C-XIV. **When inappropriate combinations of cargo and slings are used, violent vibration can occur.** The cargo is likely to be dropped to protect the helicopter.

MIL-STD-810H
METHOD 514.8, ANNEX Cc. Exposure levels.

- (1) Helicopter internal cargo vibration is a complex function of location within the helicopter cargo bay and the interaction of the cargo mass and stiffness with the helicopter structure. Measurements of the vibration of the cargo in the specific helicopter are necessary to determine vibration with any accuracy. Approximate criteria may be derived from Annex D, paragraph 2.3. These levels are intended to envelope potential worst-case environments, and have been aggressively compressed in time. Additional tailored helicopter vibration schedules are provided in TOP 01-2-603 paragraph 6.1, reference xx.

<p>NOTE: These levels are intended to envelope potential worst-case environments, and have been aggressively compressed in time (paragraph 6.1, reference ww indicates a time compression from 2500 hours to 4 hours using the equation shown in paragraph 2.3f with a value of $m=6$). They do not represent environments under which vibration-sensitive materiel should be expected to perform to specification. However, the materiel is expected to survive undamaged, and to function to specification at the completion of the test.</p>

- (2) Slung cargo levels are low and should not be a significant factor in design of materiel that has a reasonable degree of ruggedness.
- (3) Plans for development of updated vibration schedules representative of the modern rotorcraft fleet are in progress. As each aircraft's vibration schedule updates are completed, they will be provided as individual Annexes to TOP 01-2-603 (Rotorcraft Laboratory Vibration Test Schedules) along with vibration schedule development (VSD) technique details and all relevant descriptors such as mission scenario and instrumentation locations. The updated schedules will supersede the current defaults as listed in Table 514.8C-XIV. Currently there are only two rotorcraft in TOP 01-2-603, the UH-60 and the CH-47. These helicopters have therefore been removed from Table 514.8C-XIV.

- d. Exposure durations. When measured data are used to establish exposure levels, take durations from the LCEP. Otherwise refer to the guidance provided in paragraph 2.3d in Annex D of this method.

MIL-STD-810H
METHOD 514.8, ANNEX C

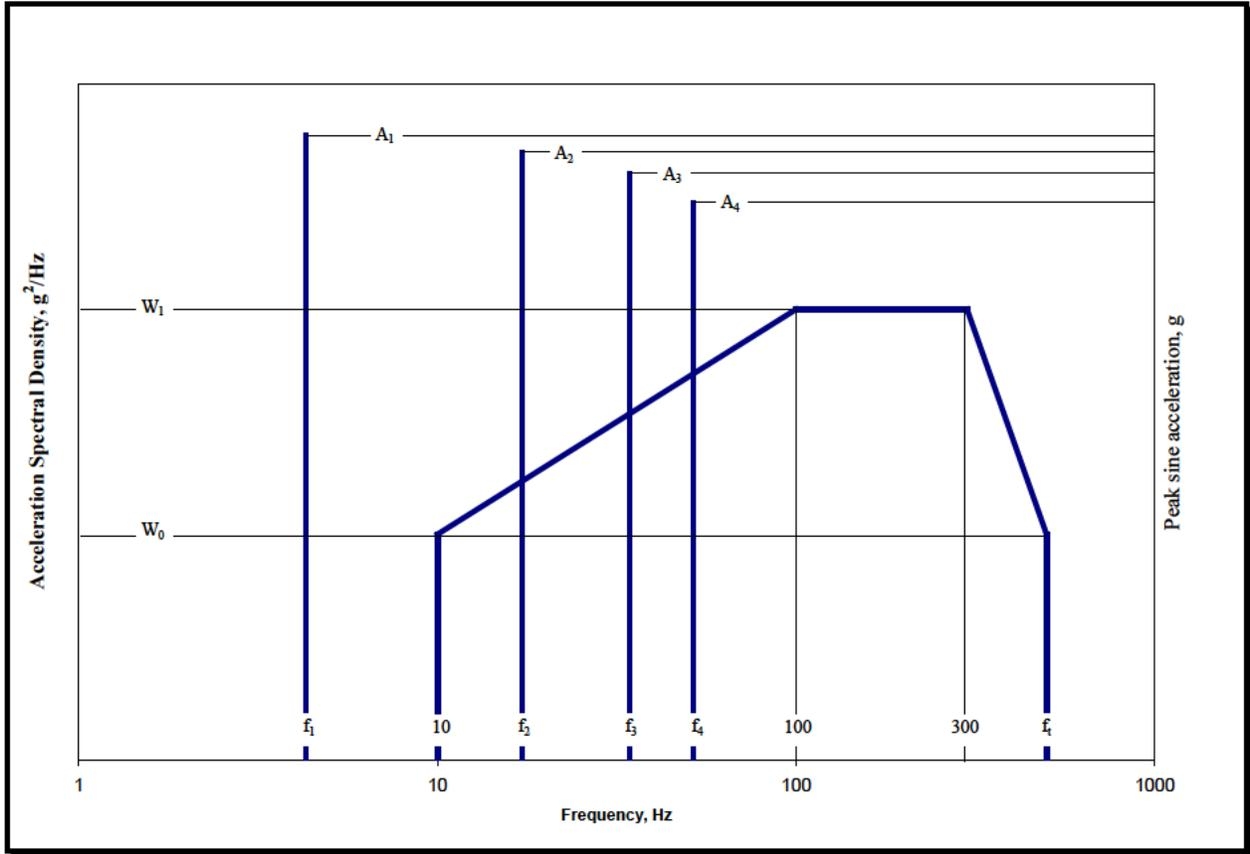


Figure 514.8C-15. Category 9 - Helicopter vibration exposure. (Same as Annex D, Figure 514.8D-4.)

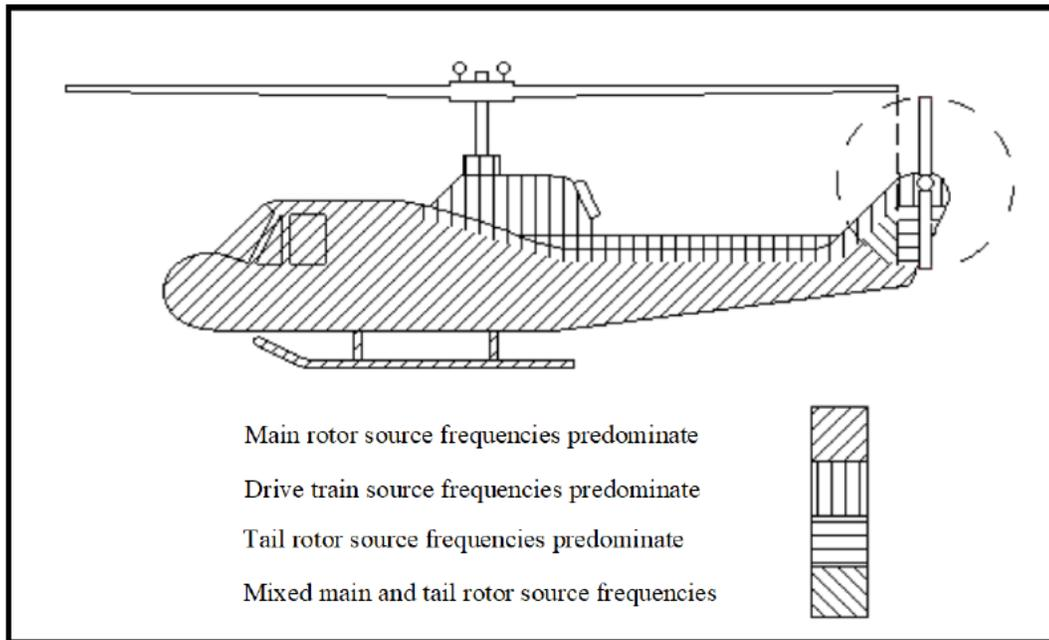


Figure 514.8C-16. Category 9 - Helicopter vibration zones. (Same as Annex D, Figure 514.8D-5.)

MIL-STD-810H
METHOD 514.8, ANNEX C

Table 514.8C-XIVa. Category 9 - Helicopter parameters. (Same as Annex D, Table 514.8D-IIIa.)

Helicopter	MAIN ROTOR		TAIL ROTOR	
	Rotation Speed 1P (Hz)	Number of Blades n	Rotation Speed 1T (Hz)	Number of Blades m
AH-1	5.40	2	27.7	2
AH-6J	7.95	5	47.3	2
AH-6M	7.92	6	44.4	4
AH-64 (early)	4.82	4	23.4	4
AH-64 (late)	4.86	4	23.6	4
CH-47D	Refer to TOP 01-2-603 (Paragraph 6.1, reference xx)			
MH-6H	7.80	5	47.5	2
OH-6A	8.10	4	51.8	2
OH-58A/C	5.90	2	43.8	2
OH-58D	6.60	4	39.7	2
UH-1	5.40	2	27.7	2
UH-60	Refer to TOP 01-2-603 (Paragraph 6.1, reference xx)			

MIL-STD-810H
METHOD 514.8, ANNEX C

Table 514.8C-XIVb. Category 9 - Helicopter vibration exposure. (Same as Annex D, Table 514.8D-IIIb.)

MATERIEL	RANDOM LEVELS	SOURCE FREQUENCY (f_x) RANGE (Hz)	PEAK ACCELERATION (A_z) at f_x (GRAVITY UNITS (g))	
General	$W_0 = 0.0010 \text{ g}^2/\text{Hz}$ $W_1 = 0.010 \text{ g}^2/\text{Hz}$ $f_t = 500 \text{ Hz}$	3 to 10 10 to 25 25 to 40 40 to 50 50 to 500	$0.70 / (10.70 - f_x)$ $0.10 \times f_x$ 2.50 $6.50 - 0.10 \times f_x$ 1.50	
Instrument Panel	$W_0 = 0.0010 \text{ g}^2/\text{Hz}$ $W_1 = 0.010 \text{ g}^2/\text{Hz}$ $f_t = 500 \text{ Hz}$	3 to ≤ 10 >10 to 25 25 to 40 40 to 50 50 to 500	$0.70 / (10.70 - f_x)$ $0.070 \times f_x$ 1.750 $4.550 - 0.070 \times f_x$ 1.050	
External Stores	$W_0 = 0.0020 \text{ g}^2/\text{Hz}$ $W_1 = 0.020 \text{ g}^2/\text{Hz}$ $f_t = 500 \text{ Hz}$	3 to ≤ 10 >10 to 25 25 to 40 40 to 50 50 to 500	$0.70 / (10.70 - f_x)$ $0.150 \times f_x$ 3.750 $9.750 - 0.150 \times f_x$ 2.250	
On/Near Drive System Elements	$W_0 = 0.0020 \text{ g}^2/\text{Hz}$ $W_1 = 0.020 \text{ g}^2/\text{Hz}$ $f_t = 2000 \text{ Hz}$	5 to ≤ 50 > 50 to 2000	$0.10 \times f_x$ $5.0 + 0.010 \times f_x$	
Main or Tail Rotor Frequencies (Hz) Determine 1P and 1T from the Specific Helicopter or from the table (below).			Drive Train Component Rotation Determine 1S from Specific Helicopter and Component.	
$f_1 = 1P$	$f_1 = 1T$	fundamental	$f_1 = 1S$	fundamental
$f_2 = n \times 1P$	$f_2 = m \times 1T$	blade passage (BP)	$f_2 = 2 \times 1S$	2 nd harmonic
$f_3 = 2 \times n \times 1P$	$f_3 = 2 \times m \times 1T$	2 nd harmonic	$f_3 = 3 \times 1S$	3 rd harmonic
$f_4 = 3 \times n \times 1P$	$f_4 = 3 \times m \times 1T$	3 rd harmonic	$f_4 = 4 \times 1S$	4 th harmonic

2.7 Category 10 - Watercraft – Marine Vehicles.

The vibration environment of cargo carried in ships is fundamentally the same as for materiel installed on ships. See Annex D, paragraph 2.10. For Navy vessels, see Method 528.1.

2.8 Category 11 - Railroad - train.

Cargo vibration levels for rail transport are generally low amplitude and have a moderately wide frequency bandwidth. The vibration levels can vary significantly with position on the railcar, load capacity, and track quality. Vertical axis vibration is typically the most severe followed by transverse and longitudinal. See Method 526.2, Rail Impact, for the shock associated with railcar longitudinal axis shock during coupling.

- a. Exposure levels. Transportation of non-isolated secured cargo on the railcar deck during cross country transportation is the typical environment. The ASD in Figure 514.8C-17 depicts the test severity at the railcar cargo deck. The vertical axis is up from the railcar deck, transverse is perpendicular across the rail tracks, and longitudinal is parallel to the rail tracks. The ASD is based on data measured at the cargo deck of different railcars including flat cars, box cars, and refrigerated cars on US rail track. The data were collected from typical rail lines with track sections across switch yards, bridges, and track crossings. The data include a varying percentage of partial cargo load to maximum capacity, and a range of railcar speeds. The typical railcar average speed for the measurements is 80 – 96 km/hr (50 to 60 mph). The ASD is a worst case envelope of the measured data, time compressed to a test time of 12 hours representing 4,800 km

MIL-STD-810H
METHOD 514.8, ANNEX C

(3000 miles) of rail transport. The ASD is not representative of high-speed magnetic levitation suspension systems. The ASD also does not represent low frequency, transient displacement and shock typical in the transverse and longitudinal axes. Additional information on the ASD background is available in reference f.

- b. Exposure durations. Wheeled vehicle vibration amplitude is typically much higher than rail vibration and may eliminate the rail transportation test requirement. Rail vibration testing may be required for fragile or large mass equipment, or items shipped primarily by rail. Define the test duration based on the LCEP if the test is required. Measurements of the actual environment are recommended. If inadequate LCEP or field measurements are available use Figure 514.8C-17 to represent the worst case environment for each orthogonal axis. The default test duration is 12 hours/axis which represents 4,800 km (3,000 miles) of rail transport. An exaggeration factor of 1.5 using a value of $m=7.5$ (see paragraph 2.2 of Annex A for further explanation of exaggeration), is applied in Figure 514.8C-17.

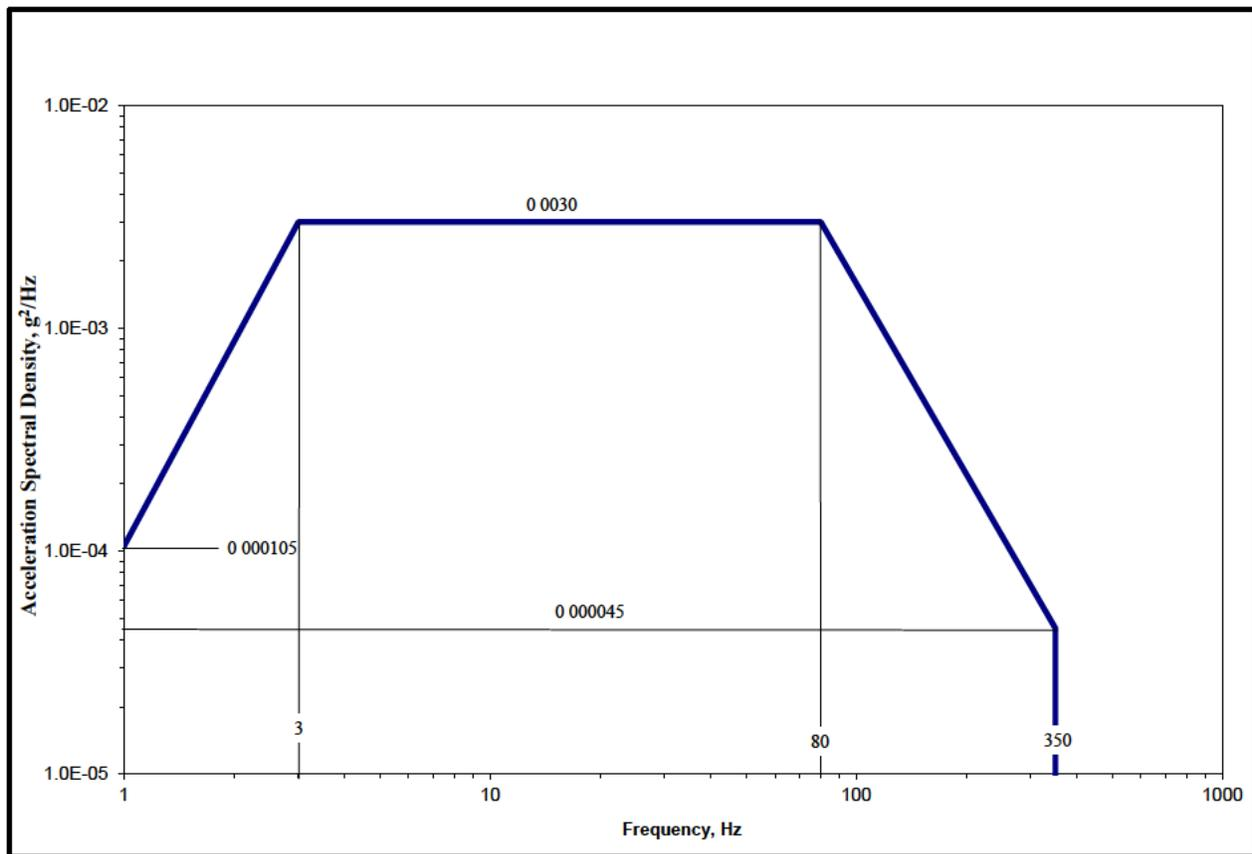


Figure 514.8C-17. Category 11 - Rail cargo vibration exposure.

MIL-STD-810H
METHOD 514.8, ANNEX D**METHOD 514.8, ANNEX D****Operational Tailoring Guidance for Vibration Exposure Definition**

NOTE: Unless specifically noted, all document references refer to paragraph 6.1 of the front part of this Method.

1. SCOPE.**1.1 Purpose.**

This Annex provides information intended to be useful in determining the vibration levels and durations of operational environmental life cycle events, and in defining the tests necessary to develop materiel to operate in and survive these environments.

1.2 Application.

Recommend actual environments be measured and materiel life cycle durations be used to develop materiel design and test criteria whenever possible. Existing databases can sometimes be used in lieu of measurements. A preliminary environmental life cycle based on data provided herein can be useful as a planning tool. A preliminary life cycle definition can be used to concentrate limited resources on those vibration exposures most significant to the materiel. Guidance for setting design and test exposure values is given below with descriptions of vibration environments of many typical life cycle events. Suggested alternate criteria (levels and durations) or other guidance is recommended for those cases where measured data defining the actual environments are not available. Table 514.8-I in the front part of this Method contains an outline of the following paragraphs with references to the paragraph numbers.

1.3 Limitations.

See paragraph 1.3 in the front part of this Method.

2. OPERATIONAL SERVICE.

This paragraph applies to materiel installed in a vehicle, aircraft store, turbine engine, or carried by personnel. Such materiel may be permanently installed or removable.

2.1 Category 12 - Fixed wing aircraft - jet aircraft.

The vibration environment for materiel installed in jet aircraft (except engine-mounted (see paragraph 2.11 of this Annex)), and gunfire-induced, (see Method 519.8) stems from four principal mechanisms. These are (1) engine noise impinging on aircraft structures; (2) turbulent aerodynamic flow over external aircraft structures, (3) turbulent aerodynamic flow and acoustic resonance phenomena within cavities open to the external airflow, particularly open weapon bays, and (4) airframe structural motions due to maneuvers, aerodynamic buffet, landing, taxi, etc. Vibration can also be produced by installed materiel items. These vibrations are generally important only locally at or near the source and may not be significant even in that local area.

- a. Airframe structural response. Airframe structural motions are the responses of flexible airframe structures to transient events. Examples of such events are landing impact, arrested landings, catapult, rebound of wings and pylons when heavy stores are ejected, and separated flow or shed vortex excitation of flight surfaces during maneuvers. Catapult take-off and arrested landing also result in structural motions. These are included in Method 516.8 as transient vibrations. Airframe structural motions are most important for the outer regions of flexible structures (i.e., outer 1/2 of wings, empennage, pylons, etc.). These vibrations are characteristic of the particular airframe involved and must be evaluated through measured data. In other areas of the airframe (fuselage, inboard wing, etc.) these vibrations are relatively mild and are generally covered by the fallback criteria described below or by minimum integrity criteria (Annex E, paragraph 2.1).
- b. Jet noise and aerodynamically induced vibration. Jet noise induced vibration is usually dominant in vehicles that operate at lower dynamic pressures, i.e., limited to subsonic speeds at lower altitudes and transonic speeds at high altitudes (paragraph 6.1, reference i). Aerodynamically induced vibration usually predominates in vehicles that operate at transonic speeds at lower altitudes, or supersonic speeds at any altitude (paragraph 6.1, references j and k).
- c. Cavity noise induced vibration. Where there are openings in the aircraft skin with airflow across the

MIL-STD-810H
METHOD 514.8, ANNEX D

opening, the corresponding cavity within the aircraft is subject to very high levels of aerodynamic and acoustic fluctuating pressures. This is because of general flow disruption and, more importantly, to a phenomenon known as cavity resonance. The fluctuating pressures can be crudely predicted analytically (see paragraph 6.1, references l and m) and somewhat more accurately measured in wind tunnel measurements. Flight test measurement is the only accurate method available to determine these pressures. Further, given the pressures, it is very difficult to predict the resulting vibration and no simple method is available. This vibration should be measured. These vibrations are likely to be important in the local areas surrounding small cavities such as flare launchers, cooling air exhaust openings, etc. With large cavities (particularly weapons bays), the resulting vibration is likely to be a major element of the overall aircraft environment. Method 515.8 contains an acoustic test simulating this environment. That procedure may be used for materiel located inside the cavity, but it is not suitable for simulating the vibration environments for areas near the cavity. Where cavities remain open continuously, the vibration is continuous. When doors or covers open, there will be a transient vibration. While the doors remain open, there is a steady state vibration, followed by another transient vibration as the doors close. When doors open and close quickly, the entire event can sometimes be characterized as a single transient vibration.

- d. Materiel induced vibration. In addition, installed materiel can produce significant vibration. Any materiel that involves mechanical motion may produce vibration. This is particularly true of those that have rotating elements such as motors, pumps, and gearboxes. The vibration output of installed materiel varies widely and is highly dependent on the mounting as well as the characteristics of the materiel. There is no basis for predicting local environments due to materiel. Materiel items must be evaluated individually. General aircraft environments as discussed above can generally be expected to cover the contribution of installed materiel.
- e. Exposure levels. Vibration criteria in the form of qualification test levels (see Annex A, paragraph 2.1.2) have been established for most airplanes developed for the military. Obtain these criteria through the program office responsible for the particular aircraft. This is the recommended basis for developing exposure levels. In cases where satisfactory criteria are not available, measured data may be available through the aircraft program office. Otherwise, measurements of actual vibrations are recommended.
 - (1) As a last resort, the guidance of Figure 514.8D-1 and Table 514.8D-I may be used to develop levels. Define both jet noise induced and aerodynamic noise induced levels for each flight condition of interest. The level for that flight condition is the envelope of the two.
 - (2) This applies to materiel that is small (light) relative to the structure that supports it. As materiel gets heavier, dynamic interaction with supporting structures increases. For typical full-scale manned aircraft, this effect is usually ignored for materiel weighing less than 36 kg (80 lb). A simple mass loading factor is included in Table 514.8D-I for heavier materiel. However, evaluate the installation of materiel weighing more than roughly 72 kg (160 lb) for dynamic interaction. (See Annex A, paragraph 2.4.)
 - (3) Materiel mounted on vibration isolators (shock mounts) is dynamically uncoupled from the support structure. Unless it is very large (heavy) relative to the support structure (see Annex A, paragraph 2.4.1), its influence on vibration of the support structure will be minimal and the mass loading factor discussed above does not apply. Use the exposure levels discussed above as input to the vibration isolators.
- f. Exposure durations. Take durations from the Life Cycle Environment Profile. Historically, the following defaults are employed in the absence of a well-defined LCEP. Note that the amplitudes computed from Table 514.8D-I are based on empirical data and time compression information is unknown.
 - (1) Environmental Worthiness test durations are either equivalent to a complete system/subsystem test, long enough to check materiel function, or an arbitrary short time (5 or 10 minutes).
 - (2) Endurance Test default durations are 1 hour/axis.
 - (3) Functional testing (when required) is recommended to be split such that one-half is conducted prior to endurance testing and one-half after endurance testing. The duration of each half of the functional test should be sufficient to fully verify equipment functionality or one-half hour per axis, whichever is greater.

MIL-STD-810H
METHOD 514.8, ANNEX D

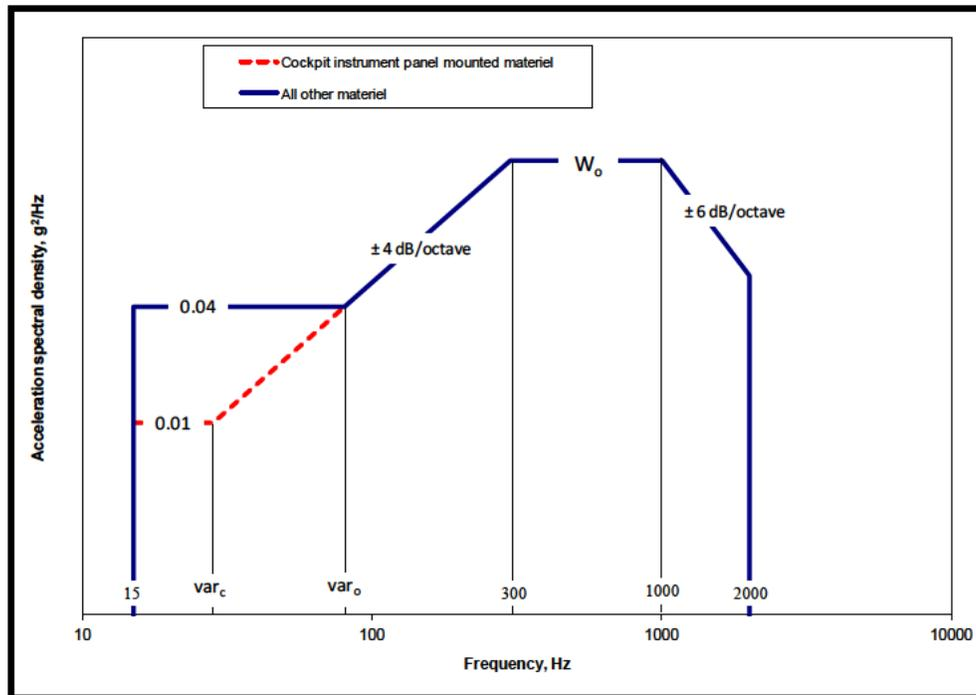


Figure 514.8D-1 - Category 12 - Fixed wing aircraft - jet aircraft. (Same as Annex C, Figure 514.8C-10.)

MIL-STD-810H
METHOD 514.8, ANNEX D

Table 514.8D-I – Category 12 - Jet aircraft vibration exposure. (Same as Annex C, Table 514.8C-X.)

$W_0 = W_A + \sum_1^n (W_J)$	
W_0, W_A, W_J - Exposure levels in acceleration spectral density (g^2/Hz).	
Aerodynamically induced vibration $W_A = a \times b \times c \times (q)^2$	
Jet engine noise induced vibration $W_J = \{[0.48 \times a \times d \times \cos^2(\theta)/R] \times [D_c \times (V_c / V_r)^3 + D_f \times (V_f / V_r)^3]\}$	
a	- Platform/Materiel interaction factor (see Annex A, paragraph 2.4). Note that this factor applies to W_0 and not to the low frequency portion (15 Hz to break) of Figure 514.8D-1. = 1.0 for materiel mounted on vibration isolators (shock mounts) and materiel weighing less than 36.3 kg. = $1.0 \times 10^{(0.6 - W/60)}$ for materiel weighing between 36.3 and 72.6 kg. (w = weight in kg) = 0.25 for materiel weighing 72.6 kg or more.
b	= Proportionality factor between vibration level and dynamic pressure (SI units). \sum_1^n - Jet noise contribution is the sum of the W_J values for each engine.
	= 2.96×10^{-6} for materiel mounted on cockpit instrument panels. = 1.17×10^{-5} for cockpit materiel and materiel in compartments adjacent to external surfaces that are smooth and free from discontinuities. = 6.11×10^{-5} for materiel in compartments adjacent to or immediately aft of external surface discontinuities (cavities, chines, blade antennae, speed brakes, etc.), fuselage aft of wing trailing edge, wing, empennage, and pylons.
	d - Afterburner factor. = 1.0 for conditions where afterburner is not used or is not present. = 4.0 for conditions where afterburner is used.
	R - Vector distance from center of engine exhaust plane to materiel center of gravity, m (ft).
	θ - Angle between R vector and engine exhaust vector (aft along engine exhaust centerline), degrees For $70^\circ < \theta \leq 180^\circ$ use 70° .
c	- Mach number correction. Note that this factor applies to W_0 and not to the low frequency portion (15 Hz to var_c or var_o) of Figure 514.8D-1. = 1.0 for $0 \leq Mach \leq 0.9$ = $(-4.8M + 5.32)$ for $0.9 \leq Mach \leq 1.0$ (where M = Mach number) = 0.52 for Mach number greater than 1.0
	D_c - Engine core exhaust diameter, m (ft).
	D_f - Engine fan exhaust diameter, m (ft).
	V_r - Reference exhaust velocity, m/sec (ft/sec). = 564 m/sec (1850 ft/sec)
	V_c - Engine core exhaust velocity (without afterburner, m/sec (ft/sec))
	V_f - Engine fan exhaust velocity (without afterburner, m/sec (ft/sec))
q	- Flight dynamic pressure, kN / m^2 (lb/ft ²). var_c - intersection frequency for cockpit materiel based on 4dB/oct slope from W_0 var_o - intersection frequency for all other materiel based on 4dB/oct slope from W_0
If Dimensions are in feet and pounds then:	
a	= 1.0 for materiel mounted on vibration isolators (shock mounts) and materiel weighing less than 80 lb. = $1.0 \times 10^{(0.60 - 0.0075 W)}$ for materiel weighing between 80 and 160 lb. = 0.25 for materiel weighing 160 lb. or more.
b	= 6.78×10^{-9} , 2.70×10^{-8} , or 1.40×10^{-7} in the order listed above.
V_r	= 1850 feet/second

MIL-STD-810H
METHOD 514.8, ANNEX D**2.2 Category 13 - Propeller aircraft.**

The vibration environment for materiel installed in propeller aircraft (except engine-mounted, see paragraph 2.11, and gunfire induced (see Method 519.8)) is primarily propeller induced. The vibration frequency spectra consists of a broadband background with superimposed spikes (see paragraph 6.1, references n through t). The spikes are more nearly sinusoidal than narrowband and are best represented utilizing sine-on-random vibration. The background spectrum results from various random sources (see paragraph 2.1) combined with many lower level periodic components due to the rotating elements (engines, gearboxes, shafts, etc.) associated with turboprops. The spikes are produced by the passage of pressure fields rotating with the propeller blades. These occur in relatively narrow bands centered on the propeller passage frequency (number of blades multiplied by the propeller rpm) and harmonics.

- a. Constant propeller speed. Most current propeller aircraft are constant-speed machines. This means that rpm is held constant and power changes are made through fuel flow changes and variable-pitch blades, vanes, and propellers. These machines produce fixed frequency spikes like those of Figures 514.8D-2 at the blade passing frequency and harmonics.
- b. Varying propeller speed. When propeller speed varies during operation, the frequency of the spikes change. This can be represented by swept sine tests with the sweep bandwidths encompassing the propeller speed variations of operation. Separate spectra may be required to describe individual mission segments.
- c. Source dwell testing. These vibration environments can be approximated in the laboratory by the source dwell test described in Annex A, paragraph 2.3.3. Vibration problems in this type of environment are typically associated with the coincidence of materiel vibration modes and excitation spikes. Intelligent designs use notches between spikes as safe regions for materiel vibration modes. It is particularly important to assure that vibration isolation frequencies do not coincide with spike frequencies. Source dwell tests minimize the likelihood that materiel will be overstressed at non-representative conditions, and ensure reasonable design provisions will not be subverted.
- d. Exposure levels. Whenever possible, use flight vibration measurements to develop vibration criteria. When measured data are not available, endurance levels can be derived from Table 514.8D-II, and Figures 514.8D-2 and 514.8D-3. Functional test levels can be derived by scaling the endurance ASD levels (broadband and L_0) by a factor of 0.35. Reliability test levels can be derived by scaling the endurance levels by a factor of 0.22. Once scaled L_0 can be converted to an equivalent sine tone (S_0) using the formula provided in Table 514.8D-II. Subsequent harmonics (S_1 , S_2 , and S_3 , corresponding to f_1 , f_2 , and f_3) are calculated from S_0 dropping 3 dB in amplitude per octave. Tests should be conducted as sine-on-random vibration, with sine levels calculated as defined in Table 514.8D-II and Figure 514.8D-2.
- e. Exposure durations. Take durations from the Life Cycle Environment Profile. If LCEP data are not available for development of the test durations, endurance tests should be conducted for one hour per axis which equivalent to 1000 hours of flight. Test durations associated with functional testing should be kept to a minimum and it is generally not considered part of the endurance test duration. Test duration for reliability testing should be set to the total flight hours required, divided equally among the three test axes, and can be considered as part of the endurance test. For equipment that will be installed on multiple fixed wing propeller aircraft the test can be divided equally between all aircraft types.

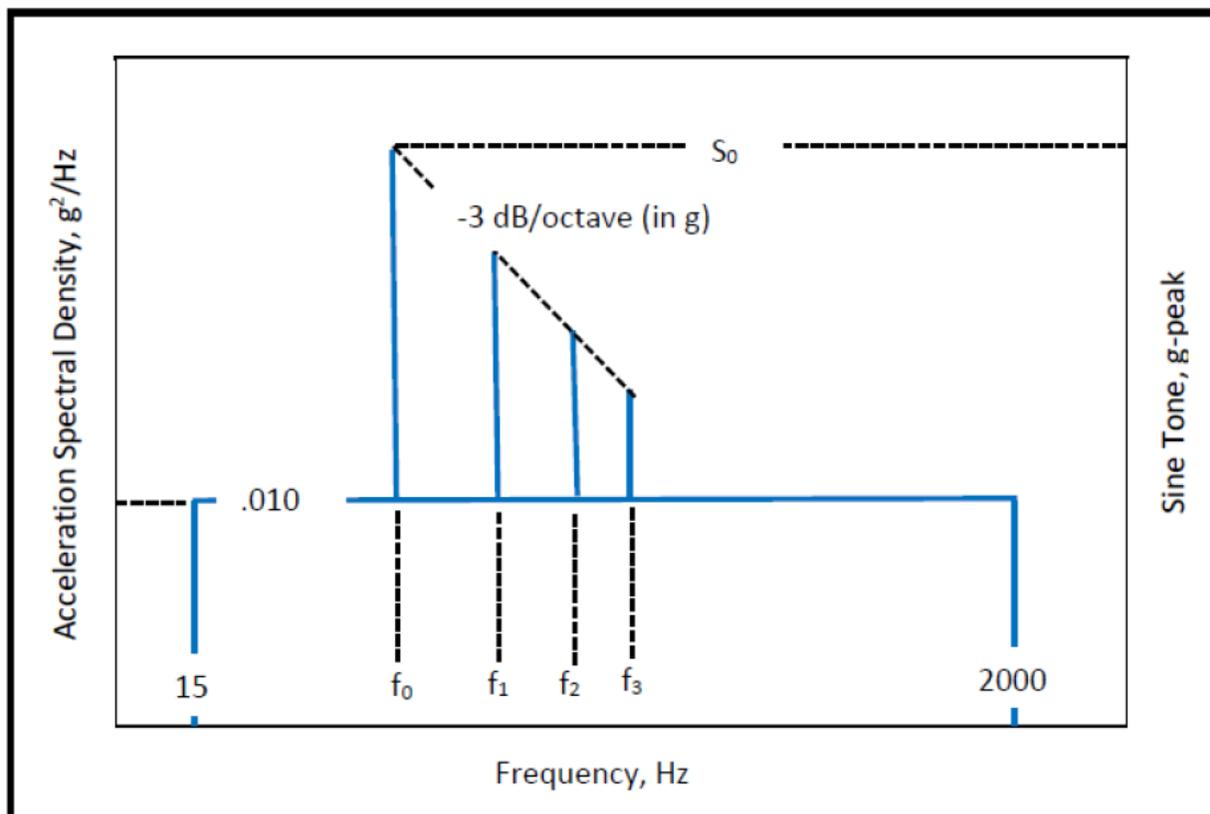
MIL-STD-810H
METHOD 514.8, ANNEX D

Figure 514.8D-2. Category 13 - Propeller aircraft vibration exposure.

Table 514.8D-II - Category 13 - Propeller aircraft vibration exposure.

TRANSPORTATION LOCATIONS (see Figure 514.8D-3)	NARROWBAND LEVEL L_0 (g^2/Hz)
In fuselage or wing forward of propeller	0.1
Within one propeller blade radius of propeller passage plane	1.2
In fuselage or wing aft of propeller	0.3
In engine compartment, empennage, or pylons	0.6
<p>1/ For Materiel mounted to external skin, increase level by 3 dB.</p> <p>2/ f_0 = blade passage frequency (propeller rpm times number of blades) (Hz). $f_1 = 2 \times f_0$ $f_2 = 3 \times f_0$ $f_3 = 4 \times f_0$</p> <p>3/ Test should be conducted as sine-on-random, with: $S_0 = 1.414 * \sqrt{0.1 * f_0 * L_0}$</p> <p>4/ Sine tones may be swept to account for known variance in blade passing frequency.</p> <p>5/ C-130 Aircraft: 4 blade propeller - $f_0 = 68$ Hz (C-130K); 6 blade propeller - $f_0 = 102$ Hz (C-130J)</p> <p>6/ Endurance test duration per axis: 1 hour for 1000 hours of flight.</p>	

MIL-STD-810H
METHOD 514.8, ANNEX D

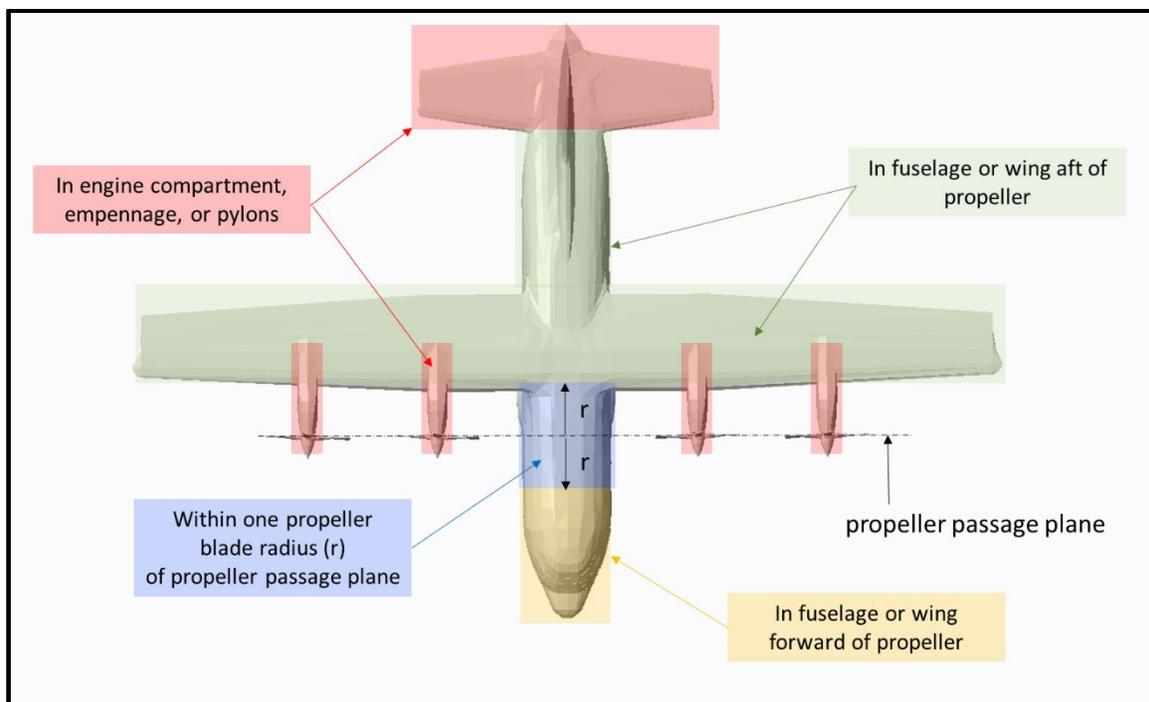


Figure 514.8D-3. Category 13 - Propeller aircraft installed equipment locations.

2.3 Category 14 - Rotary wing aircraft - helicopter.

Helicopter vibration (for engine-mounted materiel, see paragraph 2.11 below, and for gunfire induced vibration, see Method 519.8) is characterized by dominant peaks superimposed on a broadband background, as depicted in Figure 514.8D-4. The peaks are sinusoids produced by the major rotating components (main rotor, tail rotor, engine, gearboxes, shafting, etc.). The peaks occur at the rotation speed (frequency) of each component (i.e., 1P for main rotor, 1T for tail rotor, and 1S where S designates a locally predominate rotating element) and harmonics of these speeds (e.g., 2P, 3P, 4P). The broadband background is a mixture of lower amplitude sinusoids and random vibrations due to sources such as aerodynamic flow noise (see paragraph 2.1). Vibration levels and spectrum shapes vary widely between helicopter types and throughout each helicopter, depending on strength and location of sources and the geometry and stiffness of the structure. Thus, the need for measured data is acute.

- a. **Broadband background.** The broadband background is expressed as random vibration for design and test purposes as a matter of expediency. The definition of and application to design and test of all lower level sinusoidal and random components is not practical.
- b. **Dominant sinusoids.** The dominant sinusoids are generated by rotating components of the helicopter, primarily the main rotor(s), but also tail rotor, engine(s), drive shafts, and gear meshing. The normal operating speeds of these components are generally constant, varying less than five percent. However, recent designs have taken advantage of variable rotor speed control that generates a pseudo steady state rotor speed at values between 95 and 110 per cent of the nominal rotor speed. This complicates the materiel design and test process since all rotating component speeds, pseudo or otherwise, should be accounted for.
- c. **Variable rotor speeds.** Variable speed helicopters are also possible; in this case they also account for the full range of rotation speeds. A range of 0.975 times minimum speed to 1.025 times maximum speed is recommended.
- d. **Design practice.** An obvious requirement for helicopter materiel design is to avoid a match or near match between materiel resonant frequencies and the dominant sinusoids. A minimum clearance between operating speed and resonant frequency of at least five percent is recommended. It is important to note that helicopter frequencies and amplitudes are unique for each helicopter type and, to some degree, each model of a given type.

MIL-STD-810H
METHOD 514.8, ANNEX D

e. Exposure levels.

- (1) For reasons stated above, the exposure levels for materiel installed in helicopters should be derived from field measurement (additional tailored helicopter vibration schedules are provided in paragraph 6.1, reference xx). When measured data are not available, levels can be derived from Table 514.8D-III, and Figures 514.8D-4 and 514.8D-5.

NOTE: These levels are intended to envelope potential worst-case environments, and have been aggressively compressed in time (paragraph 6.1, reference ww indicates a time compression from 2500 hours to 4 hours using the equation shown in paragraph 2.3f with a value of $m=6$). **They do not represent environments under which vibration-sensitive materiel should be expected to perform to specification.** However, the materiel is expected to survive undamaged, and to function to specification at the completion of the test. Functional test levels can be derived as discussed below in paragraph 2.3e (4).

Materiel costs are often strongly influenced by the performance required in a vibration environment. Consequently, field measurement based vibration criteria can be very important and are strongly recommended.

Data acquired from variants of the rotorcraft listed in Table 514.8D-IIIa, were used to develop the random levels, source frequency relationships, and peak acceleration relationships reported in Table 514.8D-IIIb. Aircraft specific source frequencies are directly associated with rotor blade count and rotation speed. Tabulated source frequency ranges, peak acceleration amplitudes and associated random levels were empirically determined and encompass the vibration environments measured. The suitability of extrapolating these empirical peak acceleration relationships to aircraft not listed is unknown. Application of these empirical relationships to rotorcraft that are not included in the sample set should be applied with caution and only in the total absence of field data. Whenever possible, vehicle specific flight data should be acquired and employed in development of an aircraft specific vibration criterion.

- (2) To determine levels, divide the aircraft into zones as shown in Figure 514.8D-5. Use the source frequencies of the main rotor in determining the values of A_1 , A_2 , A_3 , and A_4 (Table 514.8D-III) for all materiel locations except those defined below. For materiel located in the horizontal projection of the tail rotor disc, use the source frequencies of the tail rotor. In addition, ensure criteria for materiel located in an overlap of main and tail rotor zones includes both sets of frequencies. Fundamental main and tail rotor source frequencies of several helicopters are given in Table 514.8D-III. For materiel located on or in close proximity to drive train components such as gearboxes and drive shafts, use the source frequencies of that drive train component (i.e., gear mesh frequencies, shaft rotational speeds). Determine these from the drive train data for the particular helicopter.
- (3) Plans for development of updated vibration schedules representative of the modern rotorcraft fleet are in progress. As each aircraft's vibration schedule updates are completed, they will be provided as individual Annexes to TOP 01-2-603, Rotorcraft Laboratory Vibration Test Schedules, (paragraph 6.1, reference xx) along with vibration schedule development (VSD) technique details and all relevant descriptors such as mission scenario and instrumentation locations. The updated schedules will supersede the current defaults as listed in Table 514.8D-III. Currently there are only two rotorcraft in TOP 01-2-603, the UH-60 and the CH-47. These helicopters have therefore been removed from Table 514.8D-III.
- (4) In the event that Functional Testing is to be considered it is permissible to reduce the test levels derived from Table 514.8D-IIIb by an amount which will yield levels representative of the maximum measured field levels. This is achieved by scaling the derived random levels (in g^2/Hz) by a factor of 0.18 and the peak acceleration levels (A_x in g) by a factor of 0.34. Test durations associated with Functional Testing should be kept to a minimum and it is generally not considered part of the Endurance Test duration.
- (5) In the event that Reliability Testing is to be considered it is permissible to reduce the test levels derived from Table 514.8D-IIIb by an amount which will yield a one-to-one equivalency in total test hours

MIL-STD-810H
METHOD 514.8, ANNEX D

and flight hours. This is achieved by scaling the derived random levels (in g^2/Hz) by a factor of 0.24 and the peak acceleration levels (A_x in g) by a factor of 0.41. Test duration should be set to the total flight hours required for Reliability Testing, divided equally among the three test axes and can be considered as part of the Endurance Test duration.

- f. Exposure durations. When measured data are used to establish exposure levels, take durations from the LCEP.
- g. Environment Profile. Default test duration of four (4) hours in each of three (3) orthogonal axes for a total test time of twelve (12) hours is recommended, when levels are derived from Tables 514.8D-IIIa and 514.8D-IIIb, and Figures 514.8D-4 and 514.8D-5. This test duration represents a 2500-hour operational life. If the LCEP of the UUT is other than the 2500 Hr default, modify the test duration as appropriate (i.e., a 1250 Hr LCEP would yield a 2 hour test at the default amplitudes of Table III). Such linear scaling of duration is acceptable to a minimum test duration of 0.5 Hrs. (which represents 312.5 Flight Hrs.). In the general case, it is acceptable to adjust the test durations and test levels per the guidance provided in Section 9.2.1.2 of Annex F, provided the test duration is not less than 30 minutes per axis, the test levels do not exceed the defaults derived from the tables, and the test levels are not less than the Functional Test levels defined in paragraph 2.3e(4). Seek assistance from specialist with expertise in vibration specification development as required.

Example: Consider a situation in which the 50 flight hours are required and the default amplitude for f_1 is 1.944 g-Pk. Applying linear scaling as described above yields a .08 hour test. Scale the default amplitude to yield the default minimum duration of 0.5 hours per the guidance provided in Section 9.2.1.2 of Annex F. In this example $t_1 = 0.08$ hours, $t_2 = 0.5$ hours and $W(f)_1 = 1.944$ g-Pk. Using the default slope of 6 for a sine tone yields a revised amplitude for f_1 of 1.432 g-Pk for a 0.5 hour test. (Scale the remaining tones in a similar manner). The broadband random portion of the spectrum should be scaled using a value of $m = 7.5$.

MIL-STD-810H
METHOD 514.8, ANNEX D

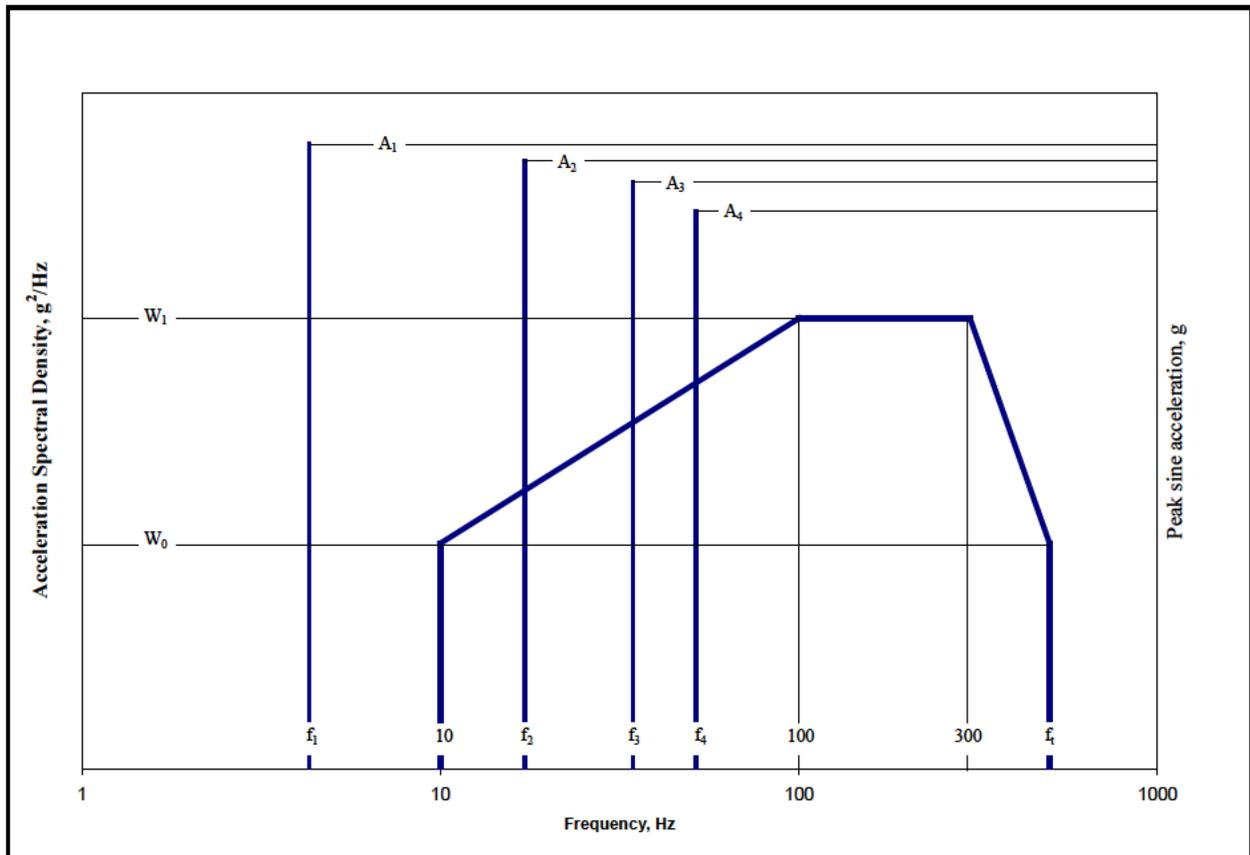


Figure 514.8D-4 Category 14 – Helicopter vibration (Same as Annex C, Figure 514.8C-15).

MIL-STD-810H
METHOD 514.8, ANNEX D

Table 514.8D-IIIa – Category 14 - Helicopter parameters. (Same as Annex C, Table 514.8C-XIVa.)

Helicopter	MAIN ROTOR		TAIL ROTOR	
	Rotation Speed 1P (Hz)	Number of Blades n	Rotation Speed 1T (Hz)	Number of Blades m
AH-1	5.40	2	27.7	2
AH-6J	7.95	5	47.3	2
AH-6M	7.92	6	44.4	4
AH-64 (early)	4.82	4	23.4	4
AH-64 (late)	4.86	4	23.6	4
CH-47D	Refer to TOP 01-2-603 (Paragraph 6.1, reference xx)			
MH-6H	7.80	5	47.5	2
OH-6A	8.10	4	51.8	2
OH-58A/C	5.90	2	43.8	2
OH-58D	6.60	4	39.7	2
UH-1	5.40	2	27.7	2
UH-60	Refer to TOP 01-2-603 (Paragraph 6.1, reference xx)			

Table 514.8D-IIIb – Category 14 - Helicopter vibration exposure. (Same as Annex C, Table 514.8C-XIVb.)

MATERIEL	RANDOM LEVELS	SOURCE FREQUENCY (f_x) RANGE (Hz)	PEAK ACCELERATION (A_z) at f_x (GRAVITY UNITS (g))	
General	$W_0 = 0.0010 \text{ g}^2/\text{Hz}$ $W_1 = 0.010 \text{ g}^2/\text{Hz}$ $f_t = 500 \text{ Hz}$	3 to ≤ 10 >10 to 25 25 to 40 40 to 50 50 to 500	$0.70 / (10.70 - f_x)$ $0.10 \times f_x$ 2.50 $6.50 - 0.10 \times f_x$ 1.50	
Instrument Panel	$W_0 = 0.0010 \text{ g}^2/\text{Hz}$ $W_1 = 0.010 \text{ g}^2/\text{Hz}$ $f_t = 500 \text{ Hz}$	3 to ≤ 10 >10 to 25 25 to 40 40 to 50 50 to 500	$0.70 / (10.70 - f_x)$ $0.070 \times f_x$ 1.750 $4.550 - 0.070 \times f_x$ 1.050	
External Stores	$W_0 = 0.0020 \text{ g}^2/\text{Hz}$ $W_1 = 0.020 \text{ g}^2/\text{Hz}$ $f_t = 500 \text{ Hz}$	3 to ≤ 10 >10 to 25 25 to 40 40 to 50 50 to 500	$0.70 / (10.70 - f_x)$ $0.150 \times f_x$ 3.750 $9.750 - 0.150 \times f_x$ 2.250	
On/Near Drive System Elements	$W_0 = 0.0020 \text{ g}^2/\text{Hz}$ $W_1 = 0.020 \text{ g}^2/\text{Hz}$ $f_t = 2000 \text{ Hz}$	5 to ≤ 50 > 50 to 2000	$0.10 \times f_x$ $5.0 + 0.010 \times f_x$	
Main or Tail Rotor Frequencies (Hz) Determine 1P and 1T from the Specific Helicopter or from the table (below).			Drive Train Component Rotation Frequency (Hz) Determine 1S from Specific Helicopter and Component.	
$f_1 = 1P$	$f_1 = 1T$	fundamental	$f_1 = 1S$	fundamental
$f_2 = n \times 1P$	$f_2 = m \times 1T$	blade passage (BP)	$f_2 = 2 \times 1S$	2 nd harmonic
$f_3 = 2 \times n \times 1P$	$f_3 = 2 \times m \times 1T$	2 nd harmonic	$f_3 = 3 \times 1S$	3 rd harmonic
$f_4 = 3 \times n \times 1P$	$f_4 = 3 \times m \times 1T$	3 rd harmonic	$f_4 = 4 \times 1S$	4 th harmonic

MIL-STD-810H
METHOD 514.8, ANNEX D

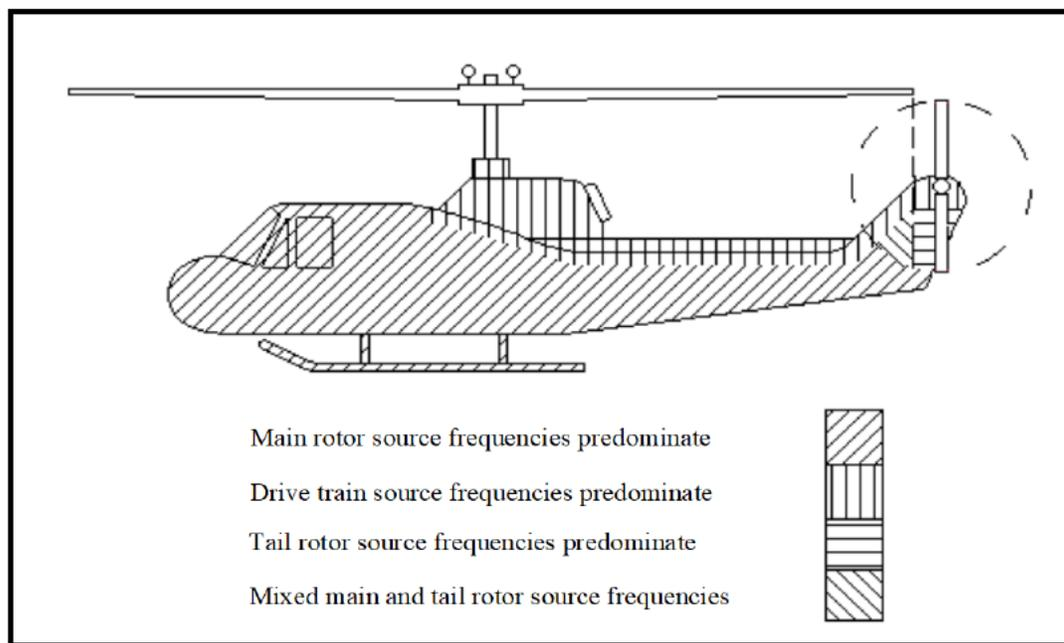


Figure 514.8D-5 – Category 14 - Helicopter vibration zones (Same as Annex C, Figure 514.8C-16).

2.4 Category 15 – Aircraft stores – assembled, jet aircraft.

Assembled jet aircraft stores may encounter three distinct vibration environments; external captive carriage, internal captive carriage, and free flight.

Note: High frequency vibration (above 1000 Hz) cannot be practically transmitted to a store mechanically. Combine store vibration and acoustic testing (Method 523.4). These test excitations in combination produce a much more realistic test.

2.4.1 Captive flight – external carriage.

Vibration (for gunfire induced vibration, see Method 519.7) experienced by a store carried externally on a jet aircraft arises primarily from four sources:

- a. Engine noise is produced by turbulence in the boundary of the jet exhaust plume. This turbulence is maximum at initiation of takeoff when the velocity difference between the jet and ambient air is maximum. This source is generally of primary importance when the store is carried on an aircraft that uses pure jet or very low bypass engines since these engines have the highest exhaust velocities. Further, it is important at higher frequencies because sources discussed below dominate at lower frequencies (paragraph 6.1, references u, v, and w).
- b. In-flight store vibration is primarily caused by aerodynamic turbulence distributed over the surface of the store.
 - (1) In single carriage, excitation is relatively independent of the carrying aircraft and mounting location on the aircraft. Local flow disturbances such as pylon wakes will vary considerably between aircraft and between store stations on a given aircraft. In general, these do not greatly affect overall store vibration. However, they may severely affect local structures such as tail fins that, in turn, may increase levels of store vibration. See Annex E, paragraph 2.1.2 for guidance on local flow effects. When stores are carried close together, the turbulence field around each is increased. A store carried behind another store is exposed to the turbulence generated by the forward store.

MIL-STD-810H
METHOD 514.8, ANNEX D

- (2) An extensive program of measurement and analysis was accomplished to characterize this environment (paragraph 6.1, references u, v, and w). Vibratory excitation is influenced by store configuration, structural configuration, mass density, and flight dynamic pressure. The high frequency portion of the resulting vibration is best represented by a combination of mechanical vibration and the acoustic noise exposures of Method 523.4. The low and medium frequency portion of this environment is better simulated by mechanical excitation. The studies mentioned above resulted in a method to accomplish this defining the response vibration of the store rather than specifying input vibration. This Method also includes low frequency vibration transmitted from the carrying aircraft (see below).
- c. Vibrations of the carrying aircraft are transmitted to the store through the attaching structures. The total vibrating system (aircraft, pylon, bomb rack, and store) is a low frequency system. That is, the lowest natural frequency of the system is typically below 20 Hertz and the store is isolated from high frequency aircraft vibration. Depending on the particular circumstances, these vibrations are often best represented as transient vibration (see Annex A, paragraph 2.3.4).
- (1) The low frequency vibration of the airframe transmitted to the store is not separable in the general case from the low frequency turbulence generated vibration. This vibration is accounted for by the method discussed under "Aerodynamic turbulence" (paragraph 2.4.1b).
 - (2) Flight test measurements on the F-15 with various external stores, (paragraph 6.1, reference x) have shown intense, very low frequency vibrations associated with aircraft buffet during high angle of attack maneuvers. Other aircraft, such as F-14, F-16, and F-18, or next generation fighters, have the potential to produce intense buffet vibrations during maneuvers.
 - (3) The F-15 buffet maneuver envelope is roughly bounded by speeds of 0.7 to 1.0 Mach and altitudes of approximately 3 to 10.7 kilometers (10,000 to 35,000 ft). Flight test measurements have shown the maximum F-15 buffet vibration to occur in the flight regime of 0.8 to 0.9 Mach, 4.6 to 7.6 km (15,000 to 25,000 ft) altitude, 8° to 12° angle of attack, and dynamic pressure less than 26.3 kN/m² (550 lb/ft²). Similar measurements on F/A-18 have shown the maximum buffet maneuver vibration to occur in the regime of 0.85 to 0.95 Mach, 1.5 to 4.6 km (5,000 to 15,000 ft.), 8° to 10° angle of attack, and dynamic pressure less than 33.5 kN/m² (700 lb/ft²). Although the vibration levels during high-performance maneuvers are very intense, they generally do not last for more than 10 seconds, reaching maximum in less than a second and deteriorating in 5 to 10 seconds. Typically, F-15 external stores will experience 30 seconds of maneuver buffet vibration for each hour of captive-carriage flight.
 - (4) Buffet vibration is typically concentrated between 10 and 50 Hz. Vibration response of the store is dominated by store structural resonances. Store loads that occur at frequencies below the lowest store natural frequency are effectively static loads. Buffet levels vary over a wide range on a given aircraft as well as between aircraft. Thus, buffet vibration requirements should be derived from in-flight vibration measurement when possible. As an alternative to measurements, the lowest store vibratory modes can be exercised at conservative levels to show that the store will be robust enough for any encountered buffet vibration. This does not cover the static loads associated with buffet. In order to include these loads, it is necessary to duplicate flight measured dynamic bending moments as discussed as an option in the front part of this Method (paragraph 4.2.1.2, Force control strategy). This would require extending the test frequency down to the lowest frequency of airplane buffet response and must be done in coordination with the responsible strength and loads engineers.
- d. Stores are also susceptible to vibration generated by internal materiel and local aerodynamic effects. There are no accepted criteria or methodology for predicting these environments. However, these environments can be dominating vibration sources and should not be ignored. Whenever they are present, they should be accounted for through development tests and measurements.
- (1) Internal materiel vibration is typically produced by rotating elements such as electric or hydraulic motors. Any device that generates or incorporates physical motion can produce vibration. Ram air turbines (RAT) are sometimes used to generate electrical or hydraulic power. A RAT can produce high levels of rotating element vibration in addition to severe aerodynamic turbulence at and behind the rotating blades.
 - (2) Acoustic resonance of simple cavities is typically handled as an acoustic environment (see Method

MIL-STD-810H
METHOD 514.8, ANNEX D

515.8). Any hole, cavity, opening, inlet, etc., that allows airflow to enter the store or a cavity in the store can produce high intensity acoustic resonance responses.

2.4.2 Captive flight – internal carriage.

There are two distinct vibration environments for stores carried in a closed, internal, aircraft bay. These environments occur when the bay is closed to the aircraft external environment and when the bay is open to this environment. Aircraft capable of high angle of attack maneuvers may be susceptible to buffet. Since buffet vibration is mechanically transmitted to the store, the bay will provide no protection. Thus the buffet vibration method discussed above applies.

- a. The general vibration environment of a store in a closed bay is very mild. The store is protected from the jet engine noise and aerodynamic turbulence environments and isolated from aircraft vibration. If a store is qualified for external carriage on any jet aircraft, this should more than adequately account for this case. There is no known method to predict this environment for the general case. Measured data may be available for specific aircraft, but generally measurements will be necessary if this environment must be defined.
- b. When the bay is opened in flight, a dramatic event occurs. This event is referred to as cavity resonance (paragraph 6.1, references l and m) and results in high levels of turbulence inside the bay. This is wide band turbulence with very high spikes across the spectrum, unless suppression devices are installed in the bay. The low frequency portions of the disturbance are not likely to drive the store because disturbance wavelengths greatly differ from store dimensions. The high frequency part of the spectrum will significantly affect the store. Store vibration resulting from this turbulence cannot be adequately predicted. Acoustic characterizations of the turbulence exist for most active aircraft and the resulting vibration is best represented by the acoustic noise exposures of Method 515.8.
 - (1) Generally, store flight surfaces (control surfaces, wings, stabilizers, etc.) are small enough (small surface area) and/or stiff enough (lowest resonant frequency above 100 Hz) that they are not significantly excited by this environment. However, in cases in which the control surfaces of the store are relatively large or soft, they may be excited by the open-bay environment. In these cases the store response can result in flight surface failure, high levels of store vibration, or both.
 - (2) In some instances, a store is carried in one configuration or position until use. Just prior to use, the configuration or position may change. For example, a weapon carried on a rotary launcher inside a weapons bay of a large bomber. The weapon moves from clock position to clock position as other weapons on the launcher are launched. The weapon is exposed to the open bay environment either each time another weapon is launched, or for a relatively long period while several are launched. Another example is a weapon that is extended out of the bay on the launch mechanism prior to launch. Here the environment will change considerably with position. A third example is an optical sensor pod. This type of store can be carried internally, extended into the air stream, configuration changed (e.g., covers over optical windows retract), operated, configuration changed back, and retracted into the closed bay many times in a lifetime. Account for such variations in environment and configuration.

Note: Door opening, position changes, configuration changes, door closing, etc., should be expected to happen rapidly. Each of these events and, possibly, a whole sequence of events can happen rapidly enough, so that they should be treated as transient (see Annex A, paragraph 2.3.4, and Method 516.8) rather than steady state vibration.

2.4.3 Free flight.

Vibration will be experienced by stores that are deployed from aircraft, ground vehicles, or surface ships. The sources of vibration for the free flight environment are engine exhaust noise, vibration, and noise produced by internal equipment and boundary layer turbulence.

- a. Generally, engine exhaust noise levels will be too low to excite significant vibration in the store. This is because the engine only operates when the ratio of the exhaust velocity to the ambient air speed is low and (except in unusual cases) the exhaust plume is behind the store.
- b. Vibration produced by onboard materiel can be severe in specific cases. Examples are ram air turbines, engines, and propellers. There is no general basis for predicting store vibrations from such sources. Each

MIL-STD-810H
METHOD 514.8, ANNEX D

case must be evaluated individually, and it is likely that measurements will be required.

- c. Boundary layer turbulence induced vibration should be as for captive carriage except that store vibration mode frequencies may shift, flight dynamic pressures may be different, and turbulence from the carrier aircraft and nearby stores will be absent.

2.4.4 Exposure levels.

Select test levels and spectra for captive flight and free flight from Table 514.8D-IV and Figures 514.8D-6 and 514.8D-7. Buffet test spectra and levels are provided in Figure 514.8D-7. The use of these tables and figures is suggested only when there is an absence of satisfactory flight measurements. Except for buffet portions, these criteria are closely based in paragraph 6.1, references u, v, and w. These document the results of an extensive study and include a large amount of information and insight. The buffet criteria are based on paragraph 6.1, reference x, and additional measurements and experience with the F-15 aircraft. It represents F-15 wing pylon buffet that is the worst known buffet environment. F-15 fuselage store stations buffet environments are generally less severe. Criteria for the other environments must be determined for each specific case.

2.4.5 Exposure durations. Take durations from the Life Cycle Environment Profile.

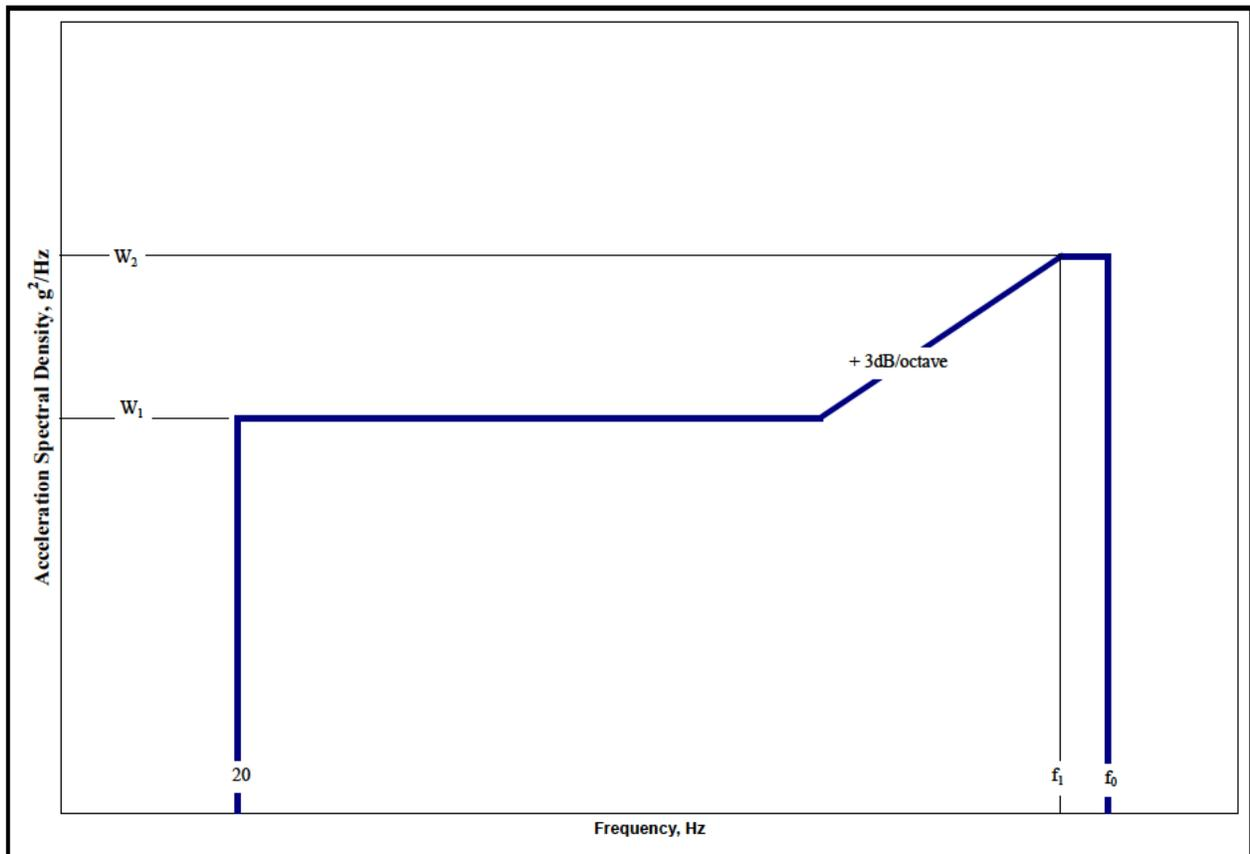


Figure 514.8D-6. Category 15 - Jet aircraft store vibration response.

MIL-STD-810H
METHOD 514.8, ANNEX D

Table 514.8D-IV. Category 15 - Jet aircraft external store vibration exposure.

$W_1 = 5 \times 10^{-3} \times K \times A_1 \times B_1 \times C_1 \times D_1 \times E_1$; (g ² /Hz) <u>1/</u>						
$W_2 = H \times (q/\rho)^2 \times K \times A_2 \times B_2 \times C_2 \times D_2 \times E_2$; (g ² /Hz) <u>1/</u>						
$M \leq 0.90$, $K = 1.0$; $0.90 \leq M \leq 1.0$, $K = -4.8 \times M + 5.32$; $M \geq 1.0$, $K = 0.52$ <u>2/</u> $f_1 = 10^5 C (t/R^2)$, (Hz) <u>3/</u> , <u>4/</u> , <u>5/</u> ; $f_2 = f_1 + 1000$, (Hz) <u>3/</u> ; $f_0 = f_1 + 100$, (Hz) <u>6/</u> , <u>7/</u>						
Configuration	Factors		Configuration	Factors		
Aerodynamically clean	A₁	A₂		B₁	B₂	
Single store	1	1	Powered missile, aft half	1	4	
Side by side stores	1	2	Other stores, aft half	1	2	
Behind other store(s)	2	4	All stores, forward half	1	1	
Aerodynamically dirty <u>8/</u>	C₁	C₂		D₁	D₂	
Single and side by side	2	4	Field assembled sheet metal			
Behind other store(s)	1	2	fin/tail cone unit	8	16	
Other stores	1	1	Powered missile	1	1	
	E₁	E₂	Other stores	4	4	
Jelly filled firebombs	1/2	1/4				
Other stores	1	1				
<p>M – Mach number. H – Constant = 5.59 (metric units) (= 5 × 10⁻⁵ English units). C – Constant = 2.54 × 10² (metric units) (= 1.0 English units). q – Flight dynamic pressure (see Table 514.8D-V) – kN/m² (lb/ft²). ρ – Store weight density (weight/volume) - kg/m³ (lb/ft³). Limit values of ρ to 641 ≤ ρ ≤ 2403 kg/m³ (40 ≤ ρ ≤ 150 lb/ft³). t – Average thickness of structural (load carrying) skin - m (in). R – Store characteristic (structural) radius m (in) (Average over store length). = Store radius for circular cross sections. = Half or major and minor diameters for elliptical cross section. = Half or longest inscribed chord for irregular cross sections.</p>						
<u>1/</u> – When store parameters fall outside limits given, consult references.			<u>5/</u> – Limit length ratio to: 0.0010 ≤ C (t/R ²) ≤ 0.020			
<u>2/</u> – Mach number correction (see Annex B).			<u>6/</u> – f ₀ = 500 Hz for cross sections not circular or elliptical			
<u>3/</u> – Limit f ₁ to 100 ≤ f ₁ ≤ 2000 Hz			<u>7/</u> – If f ₀ ≥ 1200 Hz, then use f ₀ = 2000 Hz			
<u>4/</u> – Free fall stores with tail fins, f ₁ = 125 Hz						
<u>8/</u> – Configurations with separated aerodynamic flow within the first ¼ of the store length. Blunt noses, optical flats, sharp corners, and open cavities are some potential sources of separation. Any nose other than smooth, rounded, and gently tapered is suspect. Aerodynamics engineers should make this judgment.						
Representative parameter values						
Store type	Max q		ρ		f ₁	f ₂
	kN/m ²	(lb/ft ²)	kg/m ³	(lb/ft ³)	Hz	Hz
Missile, air to ground	76.61	(1600)	1602	(100)	500	1500
Missile, air to air	76.61	(1600)	1602	(100)	500	1500
Instrument pod	86.19	(1800)	801	(50)	500	1500
Dispenser (reusable)	57.46	(1200)	801	(50)	200	1200
Demolition bomb	57.46	(1200)	1922	(120)	125	1100
Fire bomb	57.46	(1200)	641	(40)	100	1100

MIL-STD-810H
METHOD 514.8, ANNEX D

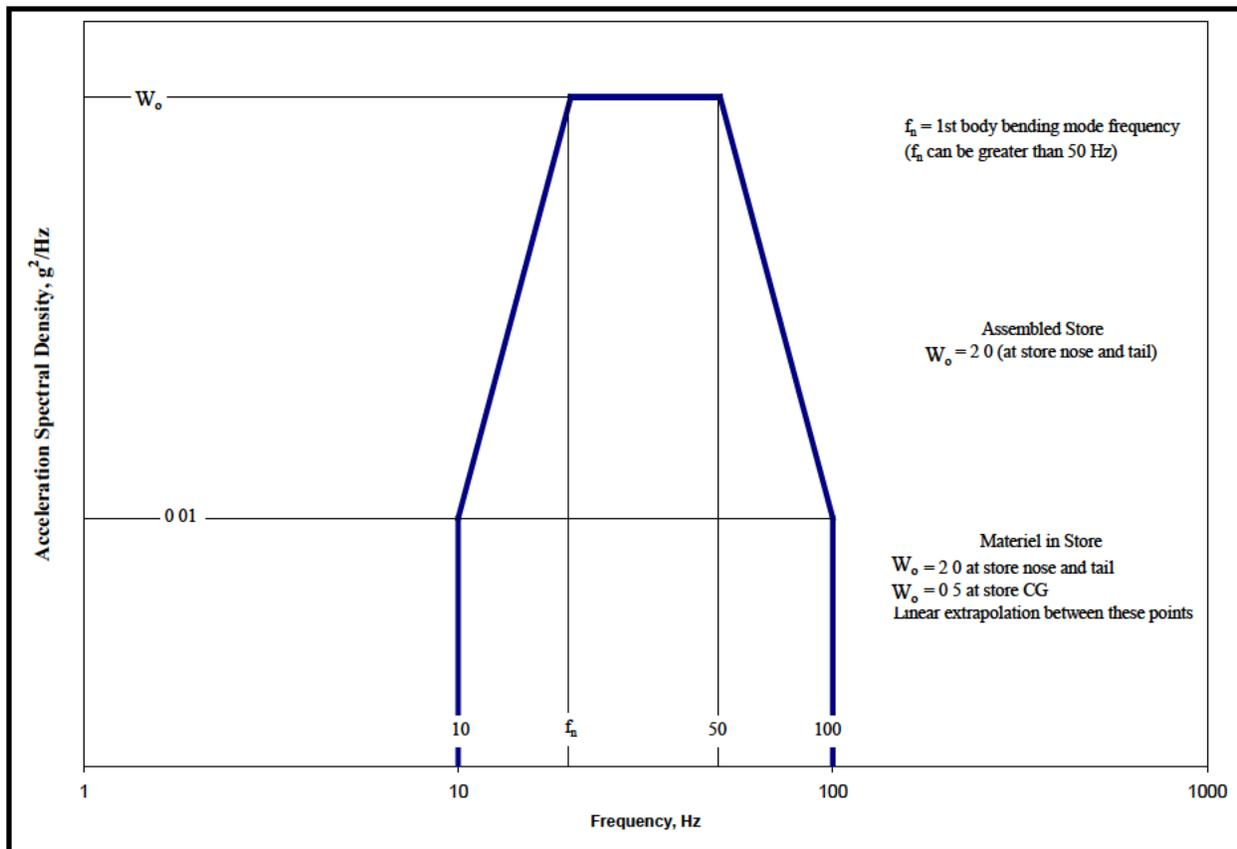


Figure 514.8D-7. Category 15 - Jet aircraft store buffet response.

MIL-STD-810H
METHOD 514.8, ANNEX D

Table 514.8D-V. Dynamic pressure calculation.

(See Annex A, paragraph 2.6.2 for definitions and details)								
1. Dynamic pressure calculation valid only for Mach numbers less than 1.0 (one).								
2. Mach number may be used at any airspeed.								
3. Unless specifically stated otherwise, assume airspeeds to be in calibrated airspeed (V_{cas}).								
4. When airspeed values are given as indicated airspeed (V_{ias}), assume V_{ias} equal V_{cas} .								
5. Altitude (h) is pressure altitude and not height above terrain.								
$q = 2.5 \rho_o \sigma V_a^2 \left[\left(\frac{1}{\delta} \left\{ \left[1 + 0.2 \left(\frac{V_{cas}}{V_{ao}} \right)^2 \right]^{3.5} - 1 \right\} + 1 \right)^{2/7} - 1 \right]$ $q = 1/2 \rho_o \sigma V_a^2 M^2 \quad q = 1/2 \rho_o V_{eas}^2 \quad q = 1/2 \rho_o \sigma V_{tas}^2$								
	$h \leq 11000 \text{ m}$	$11000 < h \leq 20056 \text{ m}$	$(h \leq 36089 \text{ ft})$	$36089 < h \leq 65800 \text{ ft}$				
θ	$1 - 2.2556 \times 10^{-5} h$	0.75189	$1 - 6.8750 \times 10^{-6} \times h$	0.75189				
δ	$\theta^{5.2561}$	$0.2234 e^\phi$	$\theta^{5.2561}$	$0.2234 e^\phi$				
V_a	$V_{ao} \times \theta^{1/2}$	295.06	$V_{ao} \times \theta^{1/2}$	968.03				
σ	$\theta^{4.2561}$	$0.2971 e^\phi$	$\theta^{4.2561}$	$0.2971 e^\phi$				
ϕ	-----	$(11000 - h) / 6342.0$	-----	$(36089 - h) / 20807$				
ρ_o	1.2251×10^{-3}	1.2251×10^{-3}	2.377×10^{-3}	2.377×10^{-3}				
V_{ao}	340.28	-----	1116.4	-----				
T_o	288.16°K	-----	518.69°R	-----				
V_{cas}	- Calibrated airspeed, m/sec (ft/sec)		ρ_o - Sea level atmospheric density kg/m^3 (slugs/ft ³ or lb sec ² /ft ⁴)					
V_{ias}	- Indicated airspeed, m/sec (ft/sec)		δ - Ratio of local atmospheric pressure to sea level atmospheric pressure					
V_{eas}	- Equivalent airspeed, m/sec (ft/sec)							
V_{tas}	- True airspeed, m/sec (ft/sec) ($V_{tas} = V_{eas} = V_{cas} = V_{ias}$ at sea level)		σ - Ratio of local atmospheric density to sea level atmospheric density (standard atmosphere)					
V_{ao}	- Sea level speed of sound, m/sec (ft/sec)		θ - Ratio of temperature at altitude to sea level temperature (standard atmosphere)					
V_a	- Local speed of sound, m/sec (ft/sec)							
M	- Mach number		ϕ - Stratospheric altitude variable					
q	- Dynamic pressure, kN/m^2 (lb/ft ²)							
h	- Pressure altitude, m (ft), (standard atmosphere)		T_o - Sea level atmospheric temperature °K (°R)					
T_o	- Sea level atmospheric temperature °K (°R)							
Airspeeds are typically expressed in knots as follows: V_{kcas} - knots calibrated air speed V_{kias} - knots indicated air speed V_{keas} - knots equivalent air speed V_{ktas} - knots true air speed [knots = nautical miles per hour (knots x 0.51478 = m/sec)(knots x 1.6889 = ft/sec)]								
Calculation Examples								
Airspeed	Pressure Altitude - h							
	1500m	(4921 ft)	3048m	(10000 ft)	7000m	(22966 ft)	10668m	(35000 ft)
	kN/m²	lb/ft²	kN/m²	lb/ft²	kN/m²	lb/ft²	kN/m²	lb/ft²
500 V_{kcas}	$q = 39.6$	$q = 827$	$q = 38.5$	$q = 803$	NA ($M > 1$)		NA ($M > 1$)	
500 V_{ktas}	$q = 35.0$	$q = 731$	$q = 29.9$	$q = 625$	$q = 19.5$	$q = 407.2$	$q = 12.5$	$q = 262$
$M = 0.8$	$q = 37.9$	$q = 791.6$	$q = 31.2$	$q = 652$	$q = 18.4$	$q = 384.2$	$q = 10.7$	$q = 223$
300 V_{keas}	$q = 14.5$	$q = 302.8$	$q = 14.6$	$q = 304$	$q = 14.6$	$q = 304.9$	$q = 14.6$	$q = 304$

MIL-STD-810H
METHOD 514.8, ANNEX D

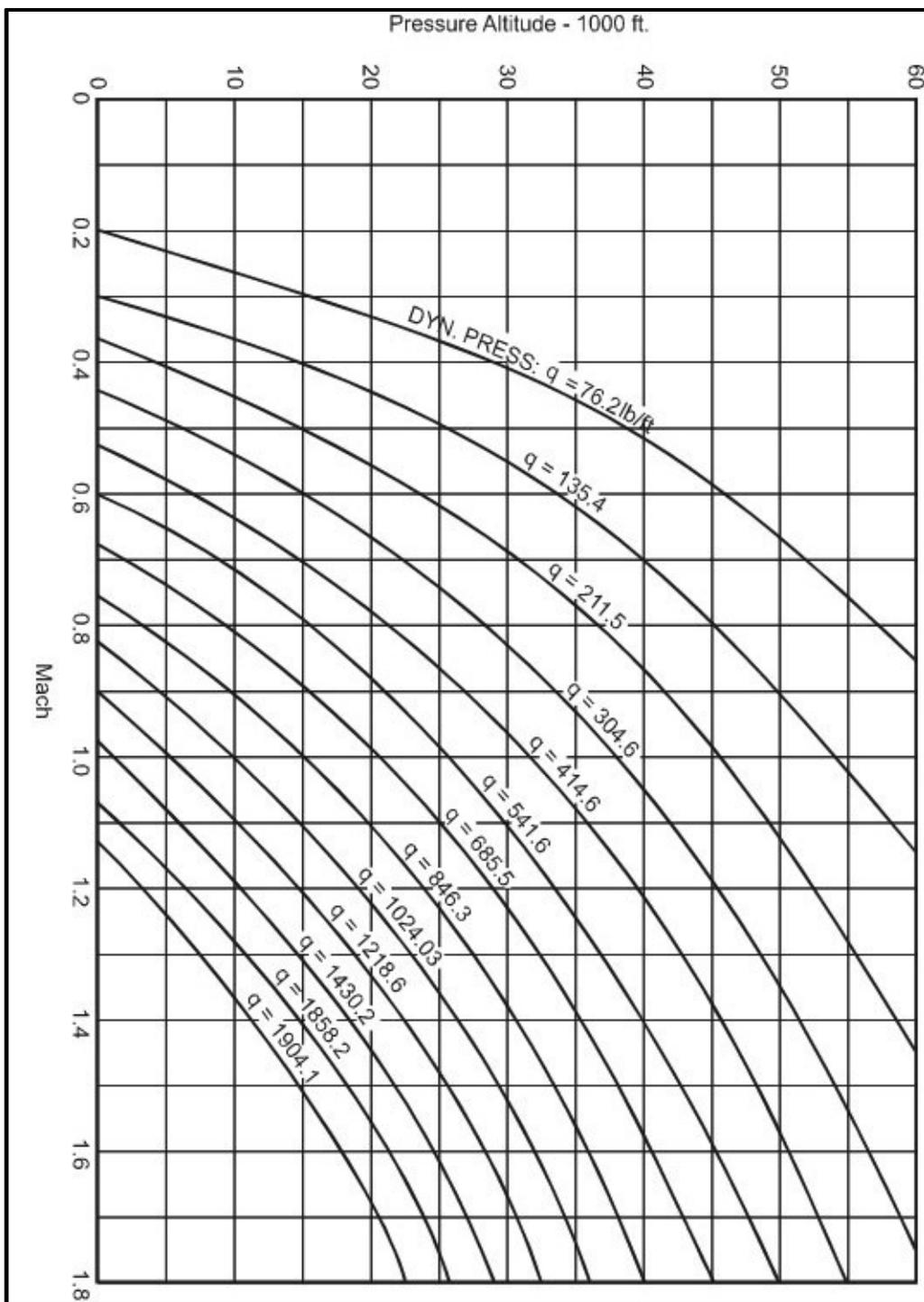


Figure 514.8D-8. Dynamic pressure as a function of Mach number and altitude.

MIL-STD-810H
METHOD 514.8, ANNEX D

2.5 Category 16 - Aircraft stores - materiel, jet aircraft.

Materiel installed within a jet aircraft store will experience the store vibration discussed in paragraph 2.4. The input exposure levels for materiel within the store are essentially the same as response levels of the store. If gunfire, cavity resonance, buffet-maneuver, and free-flight conditions occur for the store, the materiel will also be exposed to these conditions.

- a. Exposure levels. Base vibration criteria on in-flight measurements when possible. If satisfactory flight measurements are not available, derive levels from Table 514.8D-IV and Figure 514.8D-9.

Note: Use input control for vibration testing of this materiel rather than response control (see paragraph 4.2.1 in the front part of this Method).

- b. Exposure durations. Take durations from the Life Cycle Environment Profile.

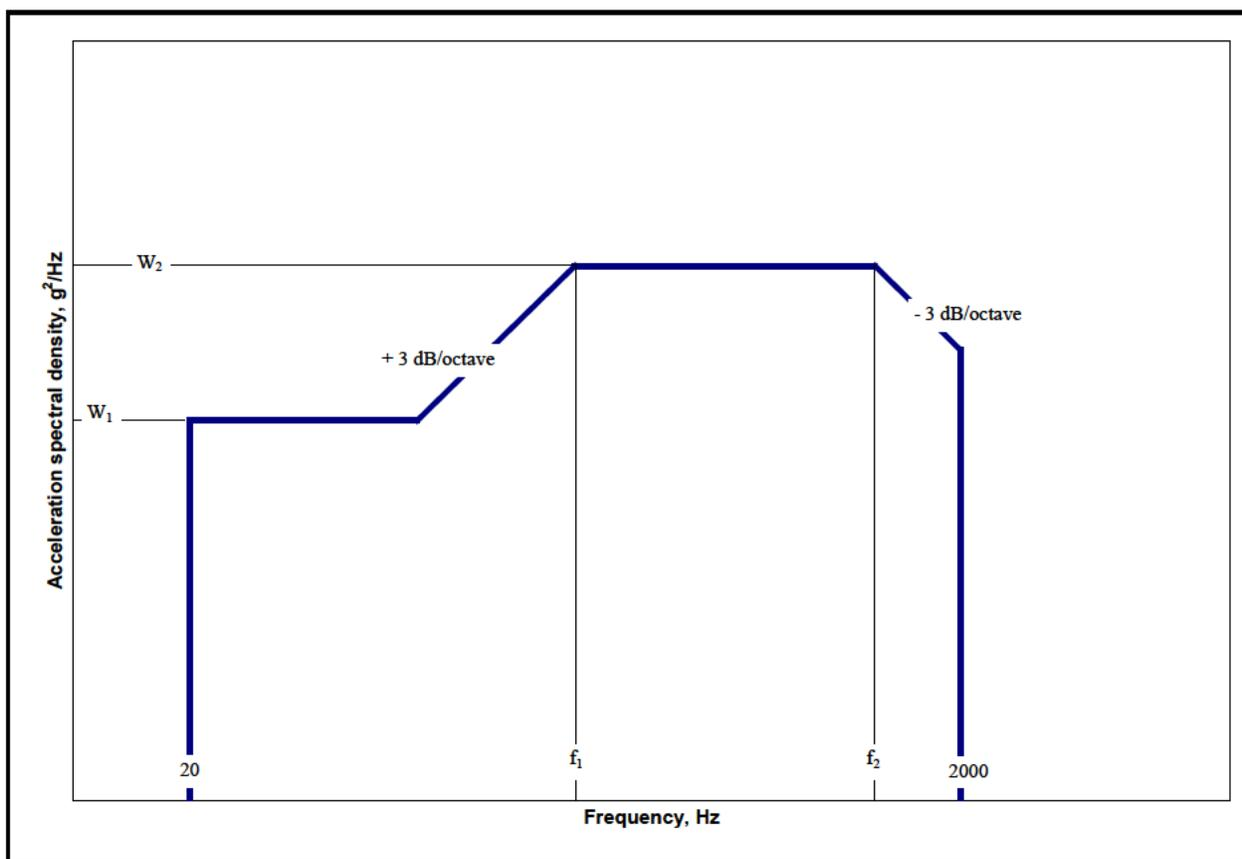


Figure 514.8D-9. Category 16 - Jet aircraft store equipment vibration exposure.

2.6 Category 17 - Aircraft stores - assembled/materiel, propeller aircraft.

There is no known source of general guidance or measured data for the vibration of propeller aircraft stores (except gunfire induced, see Method 519.8). However, since the excitation sources are the same, it seems likely that store vibration will be similar to that of the carrying aircraft. See paragraph 2.2 and Annex A, paragraph 2.3.3 for a discussion of this vibration. Maneuver buffet vibration experienced by stores of highly maneuverable propeller aircraft should be similar to that experienced by jet aircraft stores. See the buffet vibration portion of paragraph 2.4.1c.

- a. Exposure levels. There is no known source of data. For accurate definition of propeller aircraft store vibration, measurement of the actual environment is essential. The criteria of Table 514.8D-II and Figure 514.8D-2 may be used to develop preliminary estimates of general vibration. The criteria of Figure 514.8D-7 may be applied for maneuver buffet vibration.
- b. Exposure durations. Take durations from the Life Cycle Environment Profile (LCEP).

MIL-STD-810H
METHOD 514.8, ANNEX D

2.7 Category 18 - Aircraft stores - assembled/materiel, helicopter.

Complex periodic waveforms characterize the service environment encountered by assembled stores externally carried on helicopters. Unlike stores carried on fixed-wing aircraft, externally mounted helicopter stores receive little aerodynamic excitation, particularly when compared with the rotor-induced vibration. Thus, most of the vibratory energy reaches the store and materiel through the attachment points between the aircraft and the store. Some excitation, however, is added along the entire store structure due to periodic rotor-induced pressure fluctuations. The result is a complex response, unique to the particular aircraft-store configuration. Therefore, realistic definition of the environment depends almost totally upon the use of in-flight vibration measurements. For stores exposed to gunfire, refer to Method 519.8.

- a. Exposure levels. Derive exposure levels for helicopter-carried store materiel from field measurements (paragraph 6.1, reference f contains criteria for specific helicopters). When measured data are not available, initial estimates can be derived from Table 514.8D-III, and Figures 514.8D-4 and 514.8D-5, prior to acquisition of field data. These levels are intended as worst-case environments and represent environments for which it may be difficult to develop vibration sensitive materiel. Materiel costs are often strongly influenced by the performance required in a vibration environment. Consequently, field measurement based vibration criteria are very important. To determine levels, locate the store relative to the helicopter zones as shown in Figure 514.8D-5. Most stores will be inside a vertical projection of the main rotor disc and should use the source frequencies of the main rotor in determining the values of A_1 , A_2 , A_3 , and A_4 (see Table 514.8D-III). Also in Table 514.8D-III are the fundamental main rotor source frequencies of several helicopters.
- b. Exposure durations. When measured data are used to establish exposure levels, take durations from the LCEP. When levels are derived from Table 514.8D-III, and Figures 514.8D-4 and 514.8D-5, use a duration of four (4) hours in each of three (3) orthogonal axes for a total time of twelve (12) hours. This represents a 2500-hour operational life. Use the fatigue relationship of Annex A, paragraph 2.2 to trade test time for exposure level. Perform the calculation separately for each sinusoid and each segment of the broadband background.

2.8 Category 19 - Missiles - Tactical missiles (free flight).

There is no known source of general guidance or measured data for tactical missile carriage or launch vibration environments. Environments for jet aircraft, propeller aircraft, and helicopter carried missiles (stores) are discussed in paragraphs 2.4 through 2.7. Tactical carriage ground environments are discussed in paragraph 2.9. Free flight environments are covered in paragraphs 2.4.3 and 2.5 in regard to aircraft carried missiles. These environments should be generally applicable to tactical missiles during free flight mission segments.

- a. Exposure levels. There is no known source of data. For accurate definition of tactical missile free flight vibration, measurement of the actual environment is essential. The aircraft store criteria of Table 514.8D-IV and Figures 514.8D-6 and 514.8D-9 may be used to develop preliminary estimates of free flight vibration.
- b. Exposure durations. Take durations from the Life Cycle Environment Profile.

2.9 Category 20 - Ground vehicles - ground mobile. (See paragraph 6.1, references pp to vv.)

The ground mobile environment consists of broadband random vibration with peaks and notches. These peaks and notches are considerably higher and lower than the mean level. (See paragraph 6.1, reference d.) Terrain, road, and surface discontinuities, vehicle speed, loading, structural characteristics, and suspension system all affect this vibration. Gunfire criteria (Method 519.8) are not applicable since it is based on the response of aircraft-type structures that are significantly different than ground vehicle structures.

- a. Wheeled vehicles. There is presently no analytical model of these environments suitable for generalized application. A smooth spectrum similar to Annex C, Figure 514.8C-2 will be overly conservative at notches in the frequency spectrum. The spectra of Annex C, Figures 514.8C-4 through 514.8C-7 are typical of cargo bed responses in two-wheeled trailers and tactical wheeled vehicles (including four-wheeled trailers), respectively. This may be unrealistic for installed materiel since it does not consider vehicle structural response beyond the heavily supported cargo bed. The large assembly cargo test of Annex C, paragraph 2.3 can be adapted to provide highly accurate tests for this materiel.

MIL-STD-810H
METHOD 514.8, ANNEX D

- b. **Tracked vehicles.** The tracked vehicle environment is characterized by the strong influence of track patten that is related to the track pitch (length of a single track block) and the vehicle speed. The track induced component overlays a basic random environment similar to that discussed above for wheeled vehicles. This environment is best represented by superimposing narrowband random (track induced component) vibration at selected frequencies over a broadband random base. A representative tracked vehicle spectrum is given in Figure 514.8D-10. Test execution requires sweeping across the narrow band regions (rectangular shapes in Figure 514.8D-10) while maintaining the random floor. The sweeping action simulates varying vehicle speeds, and the bandwidths and sweep rates should be chosen accordingly. Because the track pitch and the mechanical vibration transmission path through the vehicle are unique to each vehicle, vibration amplitudes and frequencies are vehicle and location dependent. Detailed criteria for many tracked vehicles can be found in paragraph 6.1, reference d. Testing to this requirement will require a narrow band random-on-random vibration exciter control strategy.
- c. **Exposure levels.** As discussed above, generalized methodology for estimating ground vehicle vibration levels have not been developed. Whenever possible, actual vibration environments should be measured and the results used to formulate accurate levels and spectrum shapes. When this is not possible or when preliminary estimates are made, for wheeled vehicles, the information, levels, and curves referenced in Annex C, paragraph 2.1 (Category 4) may be adapted. Numerous measurements have been made and used to develop test criteria for tracked vehicles. Paragraph 6.1, reference d contains criteria that may be used directly or adapted as necessary.
- d. **Exposure durations.** Take durations from the LCEP. Guidance is given in paragraph 6.1, reference d, relating durations to exposure levels for various tracked vehicles.

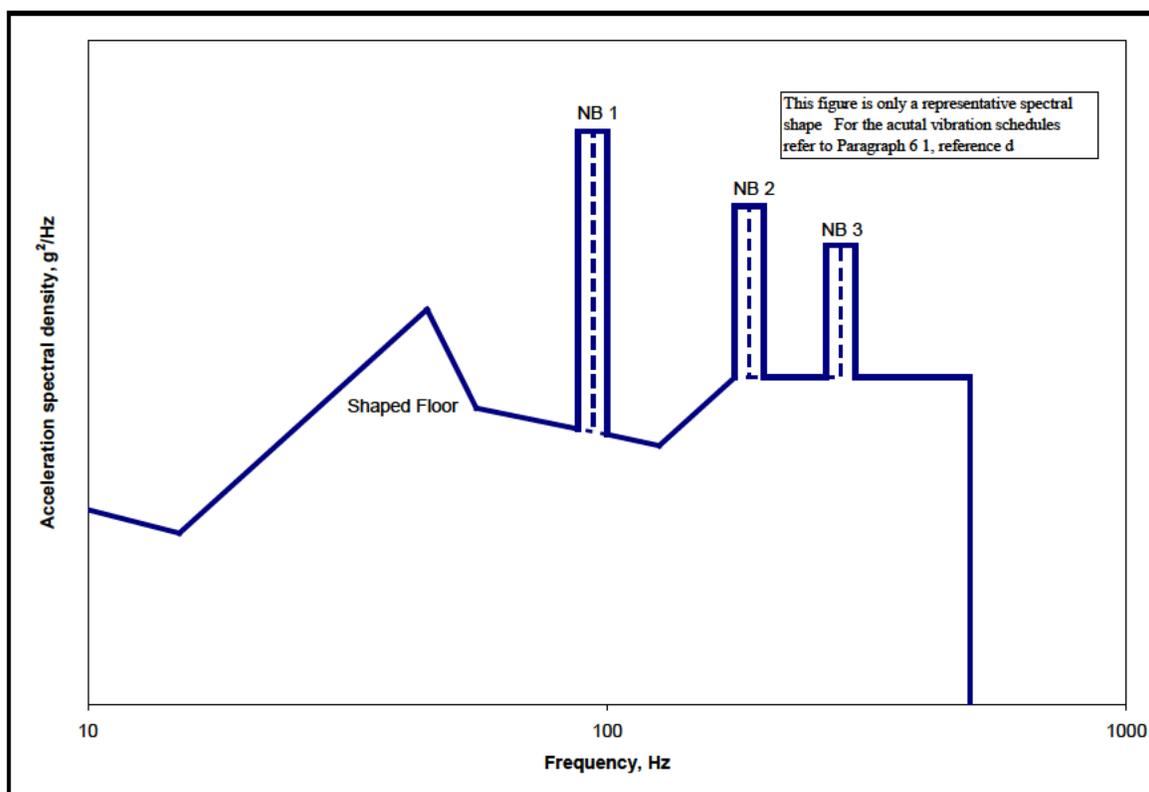


Figure 514.8D-10. Category 20 - Tracked vehicle representative spectral shape.

MIL-STD-810H
METHOD 514.8, ANNEX D**2.10 Category 21 - Watercraft - marine vehicles.**

Note: For US Navy applications refer to Method 528.1.
--

Marine vibration spectra have a random component induced by the variability of cruising speeds, sea states, maneuvers, etc., and a periodic component imposed by propeller shaft rotation and hull resonance. Materiel mounted on masts (such as antennas) can be expected to receive higher input than materiel mounted on the hull or deck. The overall ship's structure, materiel mounting structure, and materiel transmissibility (amplifications) greatly affect materiel vibration. Development of shipboard materiel should address both the levels of environmental inputs and the coincidence of materiel/mounting resonances and input frequencies. Gunfire shock criteria per Method 519.8 are not applicable since they are based on the response of aircraft type structures that are significantly different than marine vehicle structures.

- a. Exposure levels.
 - (1) Ship/watercraft vibrations are a very complex function of natural environmental forcing function (wave action, wind), induced forcing function (propeller shaft speeds, operation of other equipment, etc.), ship/watercraft structure, materiel mounting structure and materiel response. Even roughly accurate general vibration criteria are not available. Use measurements of actual environments to develop exposure criteria.
 - (2) An arbitrary qualification test requirement has been developed for shipboard materiel. This may be used as a crude definition of a total onboard life exposure. It consists of the random levels of Figure 514.8D-11 for a duration of two hours along each of three orthogonal axes, and the sinusoidal requirements of Method 528 Procedure I. In the event that actual shipboard vibration data recorded on candidate vessels show levels or frequency ranges different from those for Method 528, Procedure I, the test levels should be tailored to envelope the highest values for each frequency, with appropriate consideration given to the fatigue life of the equipment. For materiel to be installed in a US Navy ship any deviation from the defaults of Method 528 requires the approval of the responsible US Navy Warrant. This criterion applies to ships and not to other watercraft. No criteria are known to be available for other watercraft.
- b. Exposure durations. Take durations from the Life Cycle Environment Profile.

MIL-STD-810H
METHOD 514.8, ANNEX D

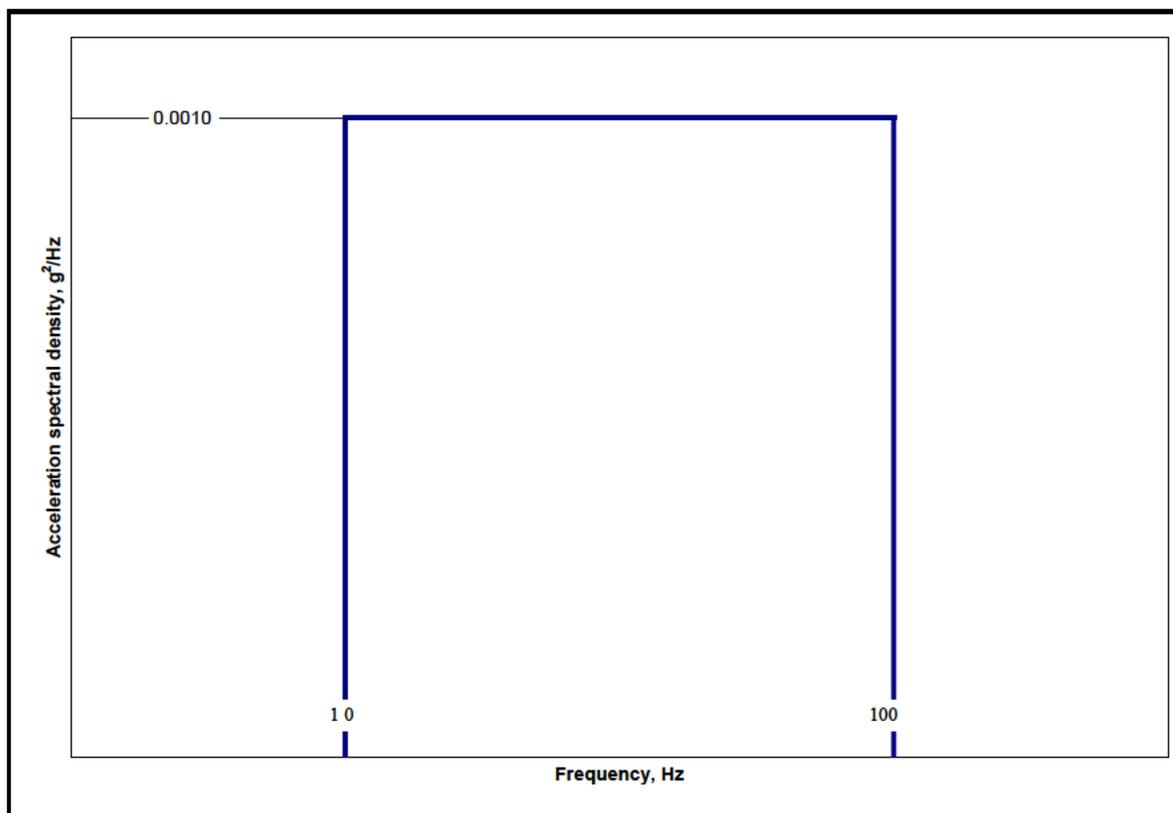


Figure 514.8D-11. Category 21 - Shipboard random vibration exposure.

2.11 Category 22 - Engines - turbine engines.

Vibration spectra for materiel mounted directly on or in close proximity to turbine engines consists of a broadband background with narrow band spikes superimposed. The broadband background is the sum of random flow turbulence and low-level quasi-sinusoidal peaks generated by various rotating machinery elements. The narrow band spikes are due to the rotation of the main engine rotor(s) and the frequencies are the rotor rotational speed(s) and harmonics.

- a. Constant speed. Many turbine engines are constant speed. This means that the rpm is held constant and power changes are made through fuel flow changes and variable pitch blades, vanes, and propellers. These machines produce the fixed frequency spikes of Figure 514.8D-12. These spikes have an associated bandwidth because there is minor rpm drift, the vibration is quasi-sinusoidal (see Annex A, paragraph 2.3.3), and the materiel resonant frequencies vary with serial number and mounting conditions.
- b. Variable speed. Other turbine engines are not constant speed machines. For these engines, the rpm varies with power setting. To represent these engines, adjust the spikes of Figure 514.8D-12 to include the engine rpm range, or alternatively, use swept sinusoidal over the engine rpm range.
- c. Multiple rotors. Multiple rotors and output shaft. Turbofan and turboshaft engines usually have two and sometimes three mechanically independent rotors operating at different speeds. Modify the spectra of Figure 514.8D-12 to include spikes for each rotor or, alternatively, used swept sinusoids for each rotor. Additionally, turboshaft engines sometimes employ gearboxes to reduce the engine output shaft speed. If the engine output shaft speed is different from one of the engine rotor speeds, modify the spectra of Figure 514.8D-12 to include spikes for the output shaft speed or, alternatively, use swept sinusoids for the output shaft speed range.
- d. Design criteria. These vibration environments can be approximated in the laboratory by the narrowband random over broadband random test described in Annex A, paragraph 2.3. Many vibration problems in this type of environment are associated with the coincidence of materiel resonant modes and the excitation spikes. The notches between spikes are used in intelligent design as safe regions for critical vibration

MIL-STD-810H
METHOD 514.8, ANNEX D

modes. Source dwell tests minimize the likelihood that materiel will be overstressed at non-representative conditions and that reasonable design provisions will not be subverted.

- e. Engine mounts. Engine vibration levels are affected by the engine mounting structure (see Annex A, paragraph 2.4). Thus, the same engine mounted in two different platforms may produce differing levels. Engine test stand levels are very likely to be different than platform levels. The locations of frequency peaks in the vibration spectrum are engine driven and will not change with the installation.
- f. Exposure levels. Measured values should be used when possible. For those tests employing time compression, test levels can be increased above measured values (see Annex A, paragraph 2.2) for the endurance portion of the test while measured values can be used for the performance portion of the test. Typically, component functional performance is checked at the beginning and at the end of the endurance test in each axis. Figure 514.8D-12 levels can be used when measured data are not obtainable. These levels are rough envelopes of data measured on several Air Force constant speed propeller applications.
- g. Exposure durations. Take durations from the Life Cycle Environment Profile.

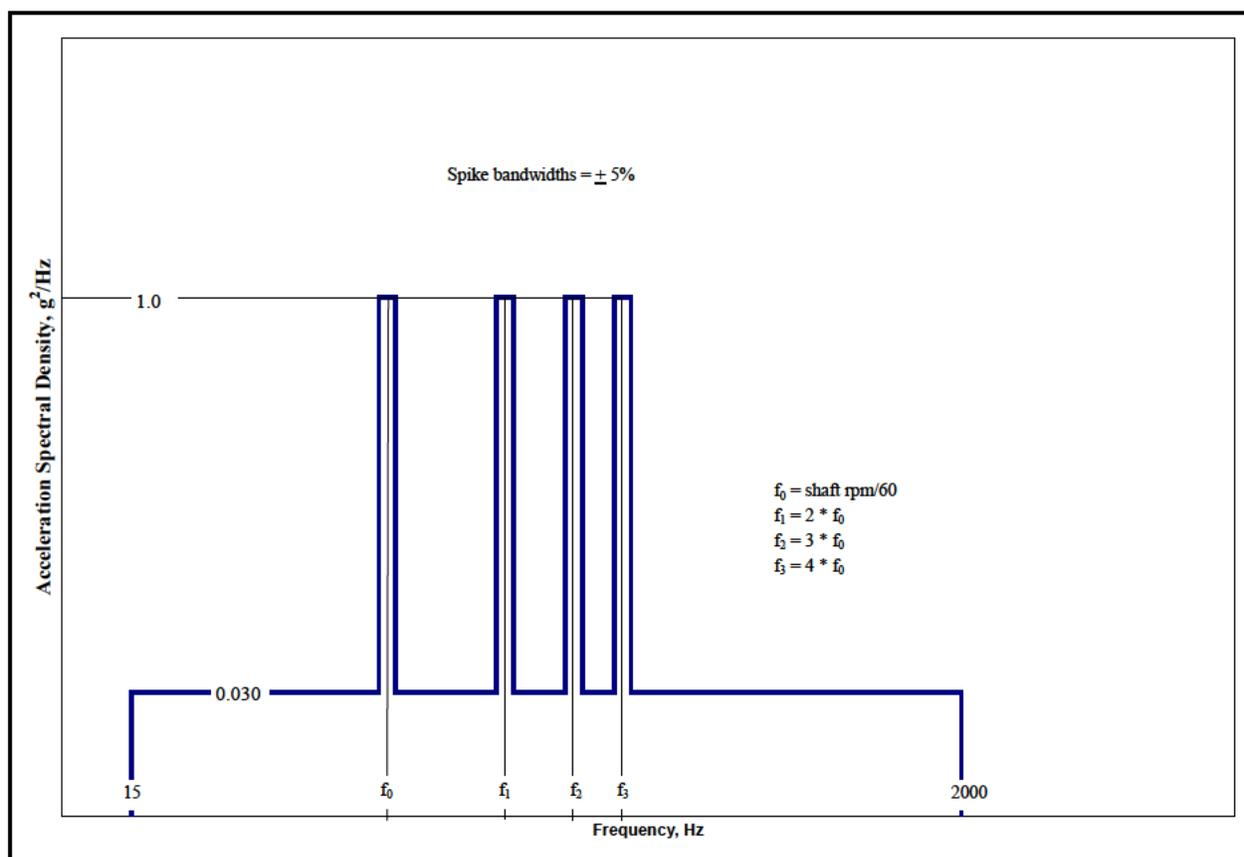


Figure 514.8D-12. Category 22 - Turbine engine vibration exposure.

2.12 Category 23 - Personnel - materiel carried by/on personnel.

The human body has highly damped, low frequency modes of vibration. Materiel carried on the body is protected from the vibration environment. Vibrations sufficient to harm materiel would be intolerable if transmitted through the body. Develop personnel materiel to withstand typical vibration environments (shipping, transportation, etc.) when the materiel is not carried by personnel.

- a. Exposure levels. No personal materiel vibration exposures are required.
- b. Exposure durations. No personal materiel vibration exposure durations are required.

MIL-STD-810H
METHOD 514.8, ANNEX D

(This page is intentionally blank.)

MIL-STD-810H
METHOD 514.8, ANNEX E**METHOD 514.8, ANNEX E**
Supplemental Tailoring Guidance for Vibration Exposure Definition

NOTE: Unless specifically noted, all document references refer to paragraph 6.1 in the front part of this Method.

1. SCOPE.**1.1 Purpose.**

This Annex provides information intended to be useful in determining the vibration levels and durations of environmental life cycle events and in defining the tests necessary to develop materiel to operate in and survive these environments.

1.2 Application.

Recommend actual environments be measured and materiel life cycle durations be used to develop materiel design and test criteria whenever possible. Existing databases can sometimes be used in lieu of measurements. A preliminary environmental life cycle based on data provided herein can be useful as a planning tool. A preliminary life cycle definition can be used to concentrate limited resources on those vibration exposures most significant to the materiel. Guidance for setting design and test exposure values is given below with descriptions of vibration environments of many typical life cycle events. Suggested alternate criteria (levels and durations) or other guidance is recommended for those cases where measured data defining the actual environments are not available. Table 514.8-I in the front part of this Method contains an outline of the following paragraph with references to the paragraph numbers.

1.3 Limitations.

See paragraph 1.3 in the front part of this Method, as well as paragraph 2.1.1a(1) below.

2. SUPPLEMENTAL TESTS.**2.1 Supplemental Considerations.****2.1.1 Category 24 : All materiel - minimum integrity tests.**

Minimum Integrity Test (MIT) methods are generally relatively unsophisticated tests that can be adopted when a precise simulation is not necessary to establish suitability for service. These are normally coupled to generalized or fallback test severities that may be used in the earlier phases of a materiel development program when adequate information may not be available to allow use of project specific severities.

Note: Tailored test methods are preferred over MIT and should be employed whenever possible. MIT cannot be used for qualification.

The MIT test category is still employed and, therefore, continues to be included within the MIL-STD-810 guidelines; however, it is placed under the category “supplemental” due primarily to the unorthodox non-tailored nature of the test category with advice to implement with care.

The minimum integrity test is intended to provide reasonable assurance that materiel can withstand transportation and handling including field installation, removal, and repair. This is particularly important for materiel that was designed and tested to requirements based only on operational service environments in which the item is mounted on vibration isolators. The same hardware is often subjected to handling, transportation, etc., without isolators, and should be tested in such configurations. Subsequent to introduction of MIT in MIL-STD-810D, Environmental Stress Screening (ESS) has become a common practice in many production facilities. Generally, ESS testing is conducted at lower levels than those proposed in Figures 514.8E-1 and 514.8E-2, and spectral shaping based on structural characteristics of the materiel may be employed. Additionally, ESS testing is generally conducted in a hard mount configuration that may address the transportation test shortcomings addressed earlier in this paragraph pertaining to otherwise shock mounted equipment.

MIL-STD-810H
METHOD 514.8, ANNEX E

Many agencies use some form of MIT based on historical knowledge of their particular service environments, and their spectra may vary from those provided within this document.

- a. Basis for levels. Vibration levels and durations of Figures 514.8E-1 and 514.8E-2 are not based on application environments. Rather, experience has shown that materiel that withstands these exposures functions satisfactorily in the field (unfortunately, much of the original documentation leading to the MIT levels was not carefully preserved). Since the MIT levels may be severe relative to most environments, failure to pass an MIT does not imply that the materiel will fail in its service environment. Failure to function subsequent to exposure to an MIT test should serve as grounds to make an attempt to define the test environment and make an effort at developing a tailored test.
 - (1) Limitations. Do not apply minimum integrity tests to materiel that has been designed and tested to all environments of its life cycle, or to materiel that is otherwise tested to levels and durations that are equivalent to the minimum integrity test by the vibratory fatigue relationships of Annex A, paragraph 2.2. MIT cannot be used for qualification tests.
 - (2) Delicate materiel. Use care with delicate materiel. Do not apply this test when the levels are felt to be too high for the materiel. Rather, evaluate the full environmental life cycle and make provisions to ensure the materiel is adequately protected from vibration and shock during all phases of the environmental life cycle - to include the transportation phase.
 - (3) Exposure levels. Test levels are shown in Figure 514.8E-1 for general use, and in Figure 514.8E-2 for helicopter materiel. These exposures are to be applied directly to the materiel (hard mounted) and not through vibration isolation devices. These exposures are based on typical electronic boxes. When materiel is too large, unnecessarily high loads are induced in mounting and chassis structures, while higher frequency vibrations at subassemblies are too low. In these cases, apply the minimum integrity test to subassemblies. The maximum test weight of a materiel or subassembly should be approximately 36 kg (80 lb).
 - (4) Exposure durations. Test durations are shown in Figure 514.8E-1 for general use, and in Figure 514.8E-2 for helicopter materiel.

In many cases, materiel is designed and tested to requirements based only on operational service environments. Other phases of the environmental life cycle are assumed to be less stringent or not considered. The minimum integrity test is intended to provide reasonable assurance that materiel can withstand transportation and handling including field installation, removal, and repair. This is particularly important for materiel mounted on vibration isolators in service and subjected to handling, transportation, etc., without isolators.

MIL-STD-810H
METHOD 514.8, ANNEX E

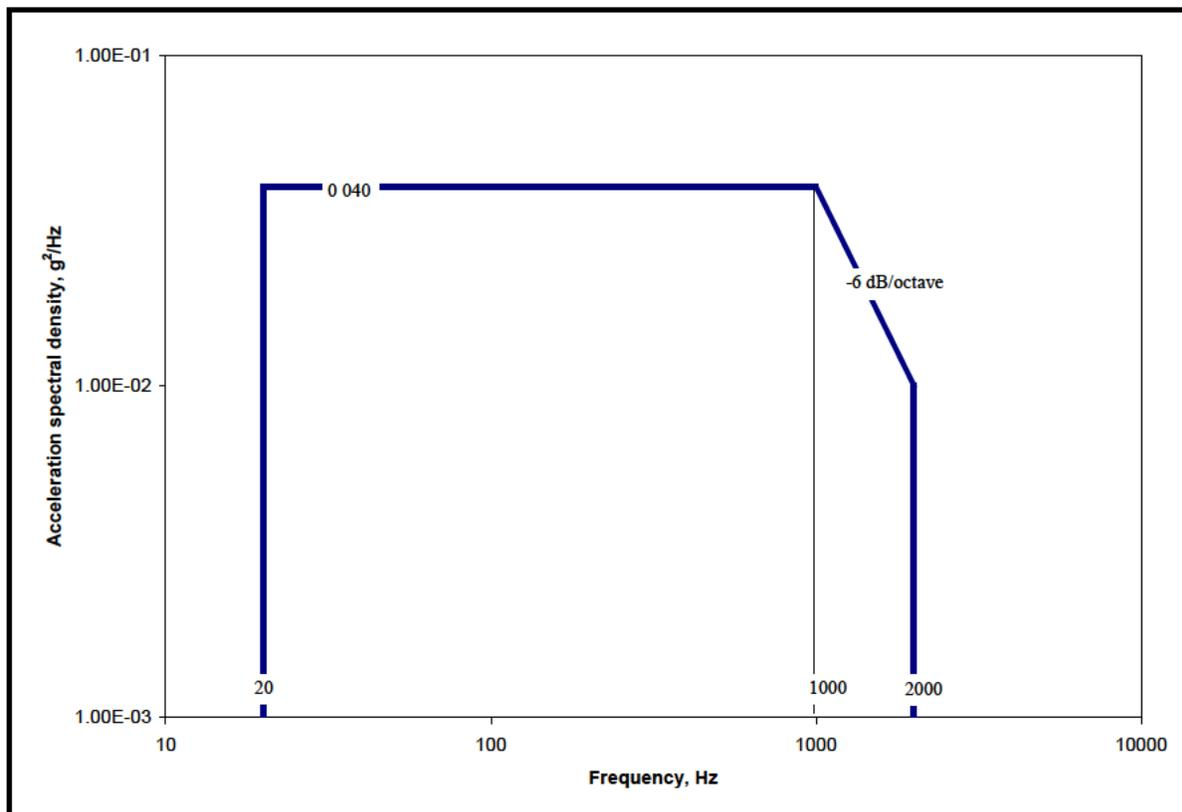


Figure 514.8E-1. Category 24 - General minimum integrity exposure.
(Test duration: One hour per axis; rms = 7.7 g's)

MIL-STD-810H
METHOD 514.8, ANNEX E

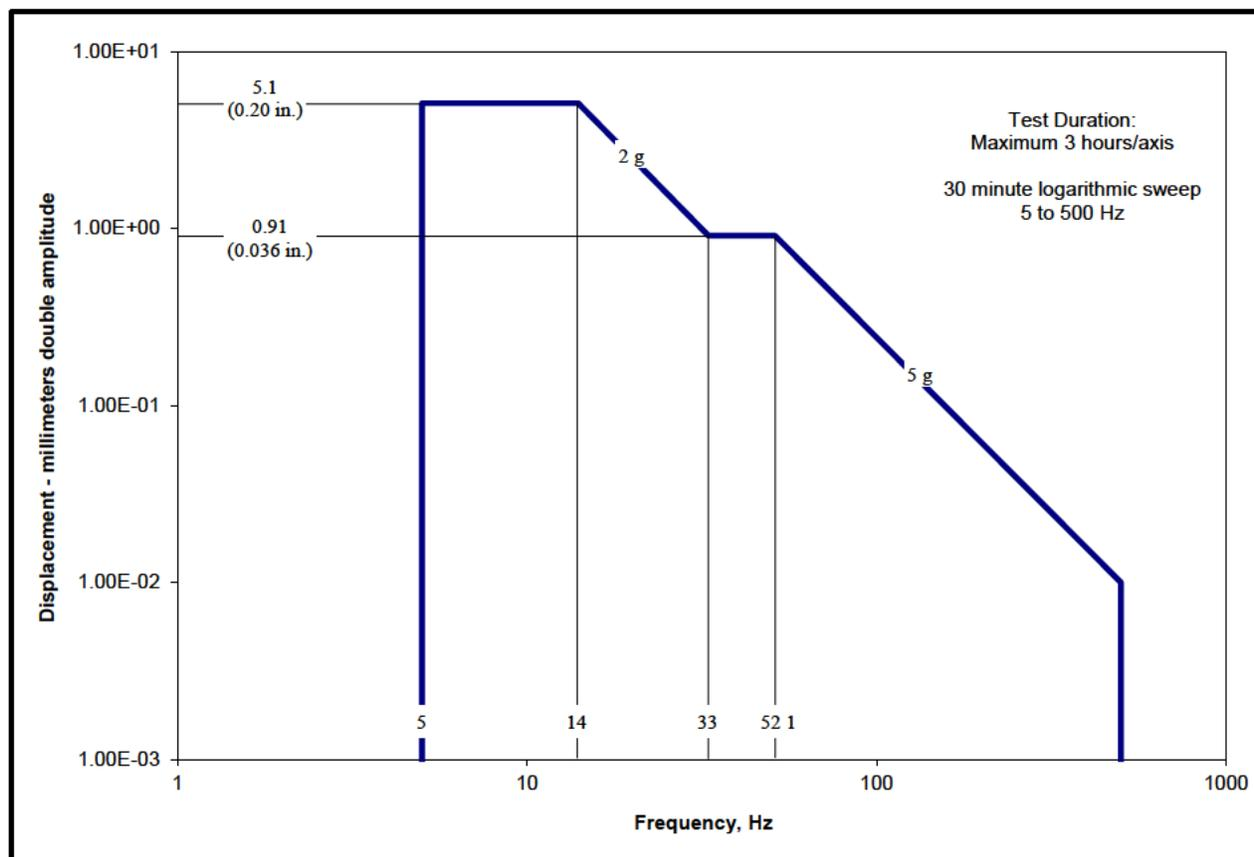


Figure 514.8E-2. Category 24 - Helicopter minimum integrity exposure. (Test duration: Maximum three hours per axis – 30 minute logarithmic sweep 5 to 500 Hz.)

2.1.2 Category 25 - All vehicles - cantilevered external materiel.

Materiel that consists of, or includes cantilever elements mounted external to a platform are subject to special problems. These problems are relatively rare but when they occur usually result in rapid and complete failure. These problems occur when the cantilevered elements are excited to vibrate in their cantilever bending or torsion modes by interaction with fluid flows.

- a. Excitation mechanisms. Cantilever elements immersed in a fluid flow can vibrate due to several types of self-excited vibration, and by forced response to pressure fluctuations. The three primary mechanisms are introduced below. For a general discussion of self-excited vibrations and more information on these three mechanisms, see paragraph 6.1, reference y, Chapter 7, and paragraph 6.1, reference z, paragraph 3.6, and chapters 5 and 6.
 - (1) Flutter is a mechanism where the vibrations of a "wing" in a flow are such as to produce lift forces and moments that reinforce and amplify the vibration. A "wing" is a cantilever beam with slender cross section (i.e., the dimension parallel to the airflow is much larger than the dimension perpendicular to the flow). Flutter is not the result of an environmental forcing function. It is a mechanism inherent in a design and once started it needs no further environmental excitation to sustain and amplify the motion. Flutter is a separate engineering specialty and should be handled by flutter engineers. The vibration engineer needs to recognize flutter and the difference between flutter and other vibrations. Many artificial problems have been generated when other types of vibrations have been mislabeled as flutter. Conversely, flutter problems will not be solved until recognized as such and treated by flutter engineers.
 - (a) A simple form is known as stall or stop sign flutter. Stop sign flutter can be seen when a plate

MIL-STD-810H
METHOD 514.8, ANNEX E

(sign) mounted on a single central metal post flaps violently in the wind. This happens when the wind blows roughly parallel, but at a small angle to the vertical plane of the plate. A pressure distribution forms over the plate as with a "wing." These pressures combine as a lifting force located upstream (1/4 mean chord) of the post. This off center force causes the plate to twist the post, increasing the angle between the plate and the wind (angle of attack). Increased angle of attack causes increased lift, more twist of the post, and larger angle of attack. This continues until either the post torsional stiffness is sufficient to stop further twisting, or until the airflow over the plate stalls. When stall occurs, the center of lift shifts to the plate center (1/2 mean chord) and the twisting moment disappears. The post (torsional spring) returns the sign to the original angle, the flow reestablishes and the plate twists again, repeating the cycle. The cycle then repeats at the frequency of the plate/post torsion mode. With road signs this cycling can go on for long periods of time without failing the simple steel post. However, when a similar oscillation occurs with more sophisticated structures, failure usually occurs rapidly.

- (b) Classical flutter is a mechanism that involves two (or more) modes. Typically these are the first bending and first torsion modes. As flow speed increases the fluid interacts with the modal masses and stiffnesses, changing modal frequencies. Flutter occurs when modal frequencies converge and the motions of the two modes couple in a mechanism that extracts energy from the fluid flow. For additional information see paragraph 6.1, reference z, paragraph 7.10 or paragraph 3.6.
- (2) When air flows over a blunt cross section (depth \approx height), vortices are shed alternately from one side, and then the other side, producing an oscillating force. These vortices are parallel to the length of the cantilever and propagate downstream as individual elements, dissipating rapidly. A blunt cross section cantilever attached to a platform moving through a fluid is subject to this force. When the excitation frequency is close to a cantilever resonant frequency, vibration will occur. When the vibrating mode is low, damped vibration can be substantial. This is another self-excited rather than an environment driven vibration. However, in this case, unlike flutter, the vibration engineer is usually expected to handle the problem.
- (a) Vibration due to vortex shedding can often be seen in the radio antennae commonly used on automobiles (the single piece non-telescoping type). When moving at speeds of roughly 80 to 97 kilometers per hour (50 to 60 miles per hour) and when there is water on the antenna, the antenna often vibrates at easily visible amplitudes. It would appear that the antennae are not failing because the vibration is in the second bending mode (2 node points). The strain distribution (mode shape) is such (again clearly visible) that dynamic bending stresses are not very high at the root of the cantilever. (It is also suspected that the antennae are made of a low-strength steel that fortuitously has good fatigue properties.)
- (b) Shed frequency and force generated are approximately equal to:

$$f = 0.22 V/D$$

$$F = (1/2 \rho V^2 DL) \sin(2\pi ft)$$

f = frequency

V = velocity

D = cantilever cross section diameter

F = force

ρ = density

t = time

L = the exposed length (perpendicular to the cross section)

(For non-circular cross sections, D becomes the dimension perpendicular to the flow in the frequency equation and the dimension parallel to the flow in the force equation. See paragraph 6.1, reference y, paragraph 7.6 for more information.)

- (3) Forced vibration of external cantilevers by fluctuations in a fluid flow is the same response to aerodynamic turbulence that is a primary source of vibration in aircraft. The factors that make this a special case for cantilevers are the dynamic characteristics of the cantilevers. First, a cantilever

MIL-STD-810H
METHOD 514.8, ANNEX E

exposes a large surface area to the excitation relative to the cross section of the support structure. Second, a cantilever tends to respond with high amplitude motion and large root stresses in the supporting base. Third, when the cantilever has the form of a "wing," aerodynamic lift and drag forces can be produced that add to the fluctuating pressure loads. These aerodynamic forces are produced because the turbulence is a tumbling of the fluid with variations in flow direction and flow velocity. These variations affect the "wing" as variations in angle of attack and flow velocity.

- (a) There are two types of excitation that are important. One is the broadband random turbulence behind any relatively blunt flow obstruction or behind a stalled airfoil. The other is vortices. A vortex forms when the pressures on two sides of a "wing" are different. The flow from the high pressure side wraps around the tip to the low pressure side. This results in a rotating flow trailing downstream of the tip. This rotating flow or vortex is left in the wake of the "wing," is highly stable, and persists for long distances downstream. Such a vortex is highly structured with a sharply peaked frequency distribution.
- (b) Vortex generators (small "wings") are often seen on airplane wings. The vortices generated help to hold the flow in the desired locations over the wing. This phenomenon can be clearly seen during takeoff of Boeing 737 aircraft equipped with CFM 56 (large diameter) engines when the air is humid. There is a vortex generator (small "wing") roughly 20 centimeters by 20 centimeters (8 inches by 8 inches) on the inboard side of each engine cowling. When the aircraft rotates to takeoff attitude, a vortex is formed that moves up over the wing and extends back parallel to the fuselage. Moisture condenses in the vortex, making it clearly visible to passengers seated at windows beside the engine and over the wing.

b. Platform environments.

(1) Fixed wing aircraft and external stores.

- (a) Any "wing" can flutter. However, this is not likely with blade antennas or the wings, control surfaces, and fins on stores. This is because first bending and first torsion mode frequencies are typically well separated. Any "wing" that has closely spaced bending and torsion mode frequencies should be evaluated by flutter engineers.
- (b) Fixed wing aircraft usually do not have blunt cross section external cantilevers. Anything outside the mold lines is generally streamlined (i.e., airfoil shaped) to reduce drag. However, if blunt cross sections are used, care should be exercised to ensure that shed frequencies and cantilever frequencies are well separated.
- (c) Many fixed wing aircraft have problems due to turbulence forced vibration. Typical problems are failed blade antennae, failed fins on external stores, and failed wings and control surfaces on missiles. Blade antenna problems are usually caused by locating the antenna downstream of a flow disturbance such as a cockpit canopy, a radome that projects into the air stream, or a cavity in the aircraft skin. Severe broadband flow turbulence carries downstream behind the disturbing element for a distance of three to five times the maximum cross sectional dimension of the disturbing element.
- (d) Fins on external stores are typically exposed to turbulence behind the carrying pylon, rack, or leading store. There is a case where a vortex forms in a corner of an engine inlet during high speed throttle chops. This vortex drops down and moves toward the airplane centerline as it extends aft. There is a single fuselage external store station that is wiped by this vortex. A specific missile carried at this station experienced high vibration levels of wings and control surfaces leading to rapid failure. The missile had to be redesigned to allow carriage on that one station.

(2) Helicopters and external stores.

- (a) Flutter of "wings" on a helicopter is not likely due to the relatively low air speeds. However, if otherwise unexplainable failures occur in "wing" like elements, a flutter engineer should be consulted.
- (b) Flight speeds of helicopters are lower than fixed wing aircraft and streamlining is not as important. Thus, blunt cross section cantilevers are more likely to be used. When blunt cross sections are

MIL-STD-810H
METHOD 514.8, ANNEX E

used, care should be exercised to ensure that vortex shed frequencies and cantilever frequencies are well separated.

- (c) Helicopters are also subject to turbulence. However, turbulence produced vibratory loads are proportional to flow speed and helicopter speeds make problems due to turbulence relatively unlikely. It is still prudent to locate cantilevered materiel away from known turbulence.
- (3) Ground vehicles.
- (a) The flapping of the fabric cover of an open truck is a form of flutter. Structures of this type will "flutter" and must be strong enough and tied down well enough to prevent carrying away. However, to replace a fabric cover with a stiffened structure is not reasonable. Flutter problems at ground vehicle speeds should be limited to cases of this type.
 - (b) Streamlining is usually not a significant factor in ground vehicle design. Thus, blunt cross-section cantilevers and vortex shedding are relatively likely. Exercise care to ensure vortex shed frequencies and cantilever frequencies are separated.
 - (c) Forced vibration problems should be extremely rare due to low flow speeds. However, turbulence does exist at any flow speed and could possibly affect large, low frequency structures. The low frequency turbulence produced by large trucks affects the handling of smaller vehicles in close proximity. Vortices in the wakes of large trucks can often be seen in disturbances of roadside dust.
- (4) Watercraft.
- (a) For the portion of the platform above water, the discussion for ground vehicles applies. Portions of the platform below water are in a higher density fluid, even though flow speeds are low, the pressures are high. Wake turbulence of watercraft is clearly visible at the water surface. "Wing" materiel is subject to flutter and blunt cantilevers including "wing" elements with blunt trailing edges are subject to vortex shedding. Much of the original work in this technology dealt with watercraft problems.
 - (b) Hulls and externally mounted underwater materiel are generally designed for smooth flow at the bow and along the sides but with squared off "boat tail" sterns. Turbulence driven forced vibration should not be a problem in smooth flow areas. However, anything located downstream of a "boat tail" will be subjected to high levels of flow turbulence.
- c. Exposure levels.
- (1) Exposure levels are not pertinent to flutter or other instabilities. These mechanisms, if they occur, will either drive the system to rapid, complete failure or will persist at high levels resulting in rapid fatigue or wear failure. The correct procedure is to design the materiel such that these mechanisms do not occur. When instabilities are discovered, the correct procedure is to understand and then eliminate the mechanism. This is accomplished by determining the mode shapes and frequencies of those resonances participating in the instability and, if possible, the characteristics of the flow field. Eliminating the mechanism is done by changing modal frequencies, mode shapes, modal damping, and/or flow characteristics. This is accomplished by changing modal mass, stiffness, or damping and/or by changing aerodynamic shapes. (See paragraph 6.1, reference z, paragraph 6.1.) Dynamic absorbers are often useful in changing modal properties (see paragraph 6.1, reference y, paragraphs 3.2 and 3.3).
 - (2) Vortex shedding driven vibration also generally leads to rapid fatigue or wear failure. This problem typically involves a single mode of vibration of the materiel. If possible, the problem should be eliminated by separating the shed frequency and the resonant frequency (ideally by a factor of 2). If this is not practical, it may be possible to survive this mechanism for useful periods of time with good design. Good design consists of using materials with good fatigue properties, elimination of high stress points, and adding damping. In order to define exposure levels, it is necessary to measure the motions of the cantilever on the platform in the operating environment. These measurements are used to define modal responses. When laboratory tests are required, response control is necessary. This is

MIL-STD-810H
METHOD 514.8, ANNEX E

because the primary energy input is directly from the fluid flow. Response of the cantilever to this input is greater than the response to the vibration environment at the mount.

- (3) Local turbulence is not predictable except in a very general sense. Problems of this type should be avoided whenever possible by locating materiel away from known turbulence areas. Beyond this, it is necessary to operate the platform through its operational envelope and evaluate problems as they occur. When problems are discovered, the first approach should be to determine the source of the turbulent wake that is causing the problem and to move the materiel out of this wake. If this is not possible, proceed as discussed for vortex shedding problems.
- d. Exposure durations. As discussed above, problems should be solved by eliminating instability mechanisms or by moving materiel away from turbulence. If it is necessary to define exposure durations, take them from the LCEP. These problems may occur in very specific regions of an operating envelope. It may be necessary to break missions down to a very detailed level in order to define realistic durations.

MIL-STD-810H
METHOD 514.8, ANNEX F**METHOD 514.8, ANNEX F****Development of Laboratory Vibration Test Schedules**

NOTE: Unless specifically noted, all document references refer to Annex F, Appendix F of this Method.

1. GENERAL.

The purpose of this annex is to present considerations and techniques for developing Laboratory Vibration Test Schedules (LVTS) that can be utilized to simulate field vibration environments on a vibration table. Laboratory vibration tests are used extensively in lieu of more time-consuming and less cost effective field exposure tests. This annex specifically addresses vibration testing controlled to frequency-domain vibration spectra and is currently limited to single mechanical degree-of-freedom scenarios.

Analysis considerations and techniques depend somewhat on the intended use of the LVTS. An LVTS developed solely for functional testing will differ from one developed to induce a full lifetime of vibration exposure. This annex primarily addresses development for the purpose of inducing a lifetime of vibration exposure, but also discusses development for other purposes.

The primary function of Vibration Schedule Development (VSD) is to combine vibration measurements of numerous events that collectively represent an item's lifetime vibration exposure into a manageable set of LVTS representing the equivalent exposure. The most dynamically accurate method to reproduce the full exposure would be to sequentially vibrate the system to all the individual, uncompressed events representing its full lifecycle. However, such an approach is generally not feasible from both schedule and economic perspectives and some compromises must be made to realize the benefits of testing in the laboratory. Time compression techniques based on fatigue equivalency are typically employed such that vibration testing can be performed in a timely and economic manner. This annex presents guidance for developing accurate representations, and issues that should be considered during the VSD process.

There is no single "best method" for VSD. Several methods have evolved at different organizations. Those methods were influenced by project specific issues, the nature of the vibration exposures, and the concerns of the given organization. This annex presents one VSD method plus two methods of combining spectra which can be useful for validation of test schedules, comparing one test schedule with another and comparing one test schedule with measured data. Critical issues are also presented that should be addressed by all methods to ensure accurate representations. Which methods are adopted may depend on the item being tested, the exposure to be replicated, the concerns of the parties involved, or other project specific factors. Ultimately, the VSD method selected must yield a set of vibration definitions and durations that collectively replicates the actual field exposure and/or induces the equivalent fatigue.

This annex addresses vibration issues only and does not address fatigue or damage potential of shock events. Shock concerns and respective test development issues are discussed in Method 516.8. Note that conditions that produce vibration may also produce shock (a pothole during road transport). Shock events should be identified, removed and addressed separately for analysis and testing.

2. REQUIREMENTS.

VSD requires a thorough knowledge of the dynamic environment in which the test hardware will be exposed when fielded. This knowledge must include characterization of the exposure levels and durations for all relevant conditions. Annex F, Appendix A presents guidelines and cautionary notes related to data acquisition.

Vibration of an item may be induced by transportation on a given platform, co-location near other vibrating equipment, self-induced, or a result of other sources. This annex is relevant as long as the expected exposure conditions and durations are understood, and the vibration levels can be measured and/or characterized.

To characterize the exposure levels, the test hardware and deployment vehicle (if applicable) are often instrumented at points of interest. The hardware is then exposed to the environments of concern and vibration data is acquired. In the event that the test items, prototypes, or carrier vehicles are not available, predictions of the vibration environment may be developed per simulation techniques provided the model fidelity is understood and has been properly verified and validated.

The duration of the vibration environments can be derived from the item's Life Cycle Environment Profile (LCEP).

MIL-STD-810H
METHOD 514.8, ANNEX F

The life cycle will include many different types of induced mechanical environments which may occur while the materiel is being handled, transported, deployed and operated. Although all the induced mechanical environments are not critical in terms of generating potential damaging response amplitudes, they contribute in varying degrees to the materiel's fatigue damage. All expected exposure conditions should be tabulated, along with corresponding durations, to form the items lifetime "scenario". The scenario is a key parameter in the development of any vibration schedule. Methods for deriving an LCEP are discussed in Part 1 of this standard and in AECTP-100 (reference a). Methods for refining a scenario for VSD are presented in this annex.

3. DEFINITIONS.

For clarity of discussion, the following definitions are provided. The definitions are not intended to be general in nature, but rather specific to the discussions in this annex.

Laboratory Vibration Test Schedule (LVTS) – All information required to perform a vibration test on a vibration exciter. Information typically includes: a broadband spectra (or profile), sine or narrowband information (if used), test run time, control accelerometer locations, control methods and tolerances, and any test specific information required.

Event – A unique exposure condition that represents some portion of the full lifecycle of a given item. Examples include flight maneuvers (i.e., forward flight at 80 percent VH) or ground vehicle conditions (i.e., paved road at 30 mph). Many events may be required to fully characterize the vibration exposure of an item.

Group – A set of events with similar vibration characteristics that are grouped together for processing.

Scenario – A tabulation of expected exposure events and the corresponding durations.

Profile – A broadband spectra that a vibration system can use as a control reference. The profile is typically provided in Auto Spectral Density (ASD) format and defined by a series of frequency and amplitude breakpoints.

Power Spectral Density (PSD) – The PSD describes how the power of a signal is distributed with respect to frequency. Vibration control systems typically use PSDs as the control reference; therefore, vibration profiles are generally developed in a PSD format. The PSD is also referred to as the auto spectral density (ASD). See Annex F, Appendix B for a description of ASD/PSD calculation methods often used. For consistency the term ASD will be used for the remainder of this Annex.

Windowing – Multiplication of a time history by a function which is zero valued outside of a given interval. Windowing is necessary for proper ASD calculation, with the Hann or Hamming windows commonly applied.

Leakage – An undesired result of windowing in which energy at one frequency leaks into adjacent frequencies. This can affect the spectral shape of the ASD and is dependent on the frequency resolution of the ASD calculations. Although the energy leaks into adjacent frequencies, the total amount of energy is preserved and the total g-rms of the ASD is unaffected.

Breakpoint – A point on the broadband profile, defined by a frequency (Hz) and a power level (g^2/Hz). Breakpoints allow the multi-point profile to be represented by a reduced set of points without overly compromising the spectral information.

Miner-Palmgren Hypothesis (Miner's Rule) – A set of mathematical equations used to scale vibration spectra and their associated test times while maintaining fatigue equivalency. A more detailed description of the Miner-Palmgren Hypothesis can be found below in paragraph 9.2.1.

Spectral Spike – Any narrowband, high-level vibration content in a vibration spectrum. The energy associated with the narrowband may be either narrowband random or sinusoidal in nature, depending upon the nature of the forcing function of the test platform. This energy is often removed from the broadband information and processed separately during analysis.

4. NATURE OF VIBRATION.

For VSD purposes, vibration can generally be classified in one of three categories. The category of vibration can affect the analysis techniques or test methods.

Sinusoidal – Vibration at a single frequency, typically of constant amplitude. Depending on the source of the

MIL-STD-810H
METHOD 514.8, ANNEX F

vibration, the frequency might remain constant (dwell) or change (sweep) over a pre-defined bandwidth.

Broadband Random – Vibration is simultaneously present at all frequencies over a wide bandwidth. The amplitude may vary significantly over the full bandwidth.

Narrowband Random – Vibration is simultaneously present over a narrow bandwidth of frequencies. Narrowband vibration is typically defined by a center frequency, a bandwidth, and amplitude. As with sinusoidal vibration, the frequency of the narrowbands is sometimes constant and sometimes swept.

An item will often undergo more than one category of vibration simultaneously. Most modern vibration test systems can produce broadband random, pure sinusoidal, sine-on-random (SOR), and narrowband random-on-random (NBROR) vibration. The sinusoids and narrowbands can either dwell or sweep.

In the field, narrowband energy is rarely pure sinusoidal or pure narrow-band random, but is more commonly a combination of the two. Unfortunately, most vibration control systems can produce either narrowband random or sine vibration at a given frequency, but not both. For that reason it is necessary to determine if the vibration of interest is more nearly sinusoidal or narrowband random in nature. This can be difficult as the leakage in ASD calculation often makes sinusoidal vibration appear to be narrowband random. One method of differentiating between sinusoidal and narrowband random data is the width of harmonically related spectral spikes. If the vibration is sinusoidal the width is a result of ASD leakage and will remain nearly constant in the harmonics. However, if the vibration is narrowband the widths will be harmonically related. Histograms and band-pass filter time histories are also helpful in determining the nature of spectral spikes.

5. PLATFORM SPECIFIC CONSIDERATIONS.

5.1 Road Transport - Wheeled Vehicle.

Equipment secured for transport in a wheeled vehicle will primarily be exposed to broadband random vibration, with the majority of the energy at low frequencies (relative to a tracked vehicle). It is often argued that items transported on both tracked and wheeled vehicle need only be tested to the tracked vehicle exposure under the assumption that tracked vehicle transport is more severe. However, this is not the case for items that may be sensitive to high-level low-frequency vibration, or the resultant high velocities and displacements characteristic of a wheeled vehicle.

Sinusoidal washboard courses are sometimes used to replicate real world exposure when road testing vehicles. Vibration data on these courses are often recorded and utilized for VSD. The vibration induced by these courses will include harmonically related spectral spikes superimposed over broadband random. Employing standard analysis techniques such as histograms, bandpass filters, and harmonic relationships between spectral spikes, one may deduce that the time histories yielding the dominant spectral spikes to be more nearly sinusoidal than narrowband in nature, with the frequencies being speed dependent. A swept SOR test is typically used to replicate washboard exposure. However, an assessment of the project specific data should be made to determine the nature of the vibration.

The terrain and severity of the vibration environment changes from relatively smooth asphalt/concrete roads through secondary roads to trails and virgin cross-country. Trails and cross-country terrains provide the most severe vibration environment for a given speed, and paved road produce the least severe. Many test tracks have been built to allow vehicle testing and data acquisition in a controlled test environment. Some of these tracks were designed specifically to replicate real world worst case environments and can be beneficial for VSD development. Other test tracks were developed to investigate aspects of vehicle handling and reliability and may not be appropriate for VSD. Courses often used for wheeled vehicle VSD include paved road, gravel road, Belgian block, radial washboard, embedded rock, two-inch washboard, and cross-country. Embedded rock and the washboard courses replicate the worst case exposure. Typically transport over asphalt/concrete roads produces vibration levels that are insignificant in comparison; therefore, that portion of a scenario is often ignored for VSD purposes. Additional wheeled vehicle transport vibration issues are discussed in AECTP 240, Leaflets 242/1, 242/5, and 245/2 (reference m).

5.2 Road Transport - Tracked Vehicle.

The vibration induced into secured equipment by tracked vehicles will include harmonically related spectral spikes superimposed over broadband random. The frequency of these narrowbands created by the interaction between the

MIL-STD-810H
METHOD 514.8, ANNEX F

tracks and hard road surface and is proportional to vehicle speed. This proportion can be described as follows:

$$f = .28 \frac{v}{p}$$

in which: f = frequency (Hz), p = track pitch (m), and v = velocity (km/h)

Employing standard analysis techniques such as histograms, bandpass filters, and harmonic relationships between spectral spikes, one may deduce that the time histories yielding the dominant spectral spikes to be more nearly narrowband random in nature than sinusoidal, with the frequencies being speed dependent. A swept NBROR test is typically used to replicate tracked vehicle exposure. However, an assessment of the project specific data should be made to determine the nature of the vibration.

Road courses typically used for tracked vehicle VSD include paved road, gravel road, and cross-country. Asphalt/concrete roads provide the most severe vibration levels in a tracked vehicle because of the relatively constant impact of the track blocks on the hard surface. Hard packed gravel or dirt secondary roads will produce levels nearly equivalent to asphalt/concrete roads and should be considered in the development of vibration schedules as well. Additional tracked vehicle transport vibration issues are discussed in TOP 01-2-601 (reference c) and AECTP 240, Leaflet 245/1 (reference m).

5.3 Air Transport - Rotor Wing.

The vibration induced into equipment transported by rotor wing platforms (whether captive carry, mounted internally, or secured in the cargo area) will include harmonically related spectral spikes superimposed over broadband random. Employing standard analysis techniques such as histograms, bandpass filters, and harmonic relationships between spectral spikes, one may deduce that the time histories yielding the dominant spectral spikes to be more nearly sinusoidal in nature than narrowband random, with the frequencies being dependent upon the number of rotor blades and the main rotor rate. Predominate frequencies are determined by the normally constant blade passing frequency and are independent of vehicle speed. Vibration of equipment mounted near the tail rotor may be dominated by the tail rotor blade passing frequency. A SOR test is typically used to replicate rotor wing platform exposure, with the sine tone frequencies held constant. However, an assessment of the project specific data should be made to determine the nature of the vibration.

Vibration severity is related to flight conditions. The vibration environment at a given location in or on a helicopter is affected by the power output of the engine, the aerodynamic buffeting of the rotor(s), and atmospheric conditions. VSD should include analysis of all aircraft maneuvers that constitute a significant portion of the expected flight time and that produce significant vibration amplitudes. Additional rotor wing transport vibration issues are discussed in TOP 01-2-603 (reference q) and AECTP 240, Leaflet 242/3 (reference m).

5.4 Air Transport - Fixed Wing.

Vibration environments on jet aircraft are broadband random in nature. The maximum vibrations are usually engine exhaust noise generated during takeoff. Levels drop off rapidly after takeoff to lower level cruise levels that are boundary layer noise generated.

Vibration environments on propeller aircraft are dominated by relatively high amplitude, approximately sinusoidal spectral spikes at propeller passage frequency and harmonics. Some aircraft have fixed-pitch, variable-speed rotor blades and in these cases the rotor speed and hence rotor related spectral spikes vary with engine speed over a wide frequency band. In this case a swept SOR test is likely to be appropriate. Other aircraft have variable-pitch, constant-speed rotor blades and in these cases the rotor speed is designed to be constant and therefore the rotor related spectral spikes should remain constant. However even in this later case minor rotor speed variation is likely resulting in rotor related spectral spikes varying in frequency by up to 1 percent of nominal frequency. These minor variations can usually be ignored. In addition to the sinusoidal spectral spikes there is wide band vibration at lower levels across the spectra. This wide band vibration is primarily due to boundary layer flow over the aircraft. Additional fixed wing air transport vibration issues are discussed in AECTP 240, Leaflet 242/3 (reference m).

5.5 Sea Transport.

Marine vibration spectra have a random component induced by the variability of cruising speeds, sea states, maneuvers, etc., and a periodic component imposed by propeller shaft rotation, hull resonance and local equipment tones often related to main power. Materiel mounted on masts (such as antennas) can be expected to receive higher

MIL-STD-810H
METHOD 514.8, ANNEX F

input than materiel mounted on the hull or deck. The overall ship's structure, materiel mounting structure, and materiel transmissibility (amplifications) greatly affect materiel vibration. VSD for shipboard materiel should address both the levels of environmental inputs and the coincidence of materiel/mounting resonances and input frequencies although in the transport by sea case, the vibration amplitudes are relatively benign and can often be considered as if they were wideband in nature. It is often not necessary to test for sea transport if an item is tested to other more severe transport, such as ground or jet aircraft transport. Additional sea transport vibration issues are discussed in AECTP 240, Leaflet 242/4 (reference m). For US Navy vessels refer to Method 528.1.

5.6 Rail Transport.

Vibration levels for rail transport are generally low in level and moderately wideband. Vertical axis vibration is typically more severe than transverse and longitudinal. It is often not necessary to test for rail transport if an item is tested to other more severe transport, such as ground transport. Additional rail transport vibration issues are discussed in AECTP 240, Leaflet 242/2 (Annex F, Appendix F reference m).

6. DATA COLLECTION, REVIEW AND SELECTION.

The data set for a typical VSD project is usually quite large. Data may have been acquired for multiple loading configurations or multiple platforms. For each configuration, many events are generally required to completely characterize the system's vibration exposure. Data is often acquired for multiple repetitions of each event. Some data acquisition issues are discussed in Annex F, Appendix A. The first step of any VSD project is to thoroughly review the data set for validity, accuracy, and content.

Various commercially available data analysis software tools are utilized for the data review. A review for accuracy may include a study of the time histories for possible erroneous data, comparison of channels at similar locations, comparison to historic data of similar vehicles, a search for outliers, and various test specific interests. Any erroneous data should be noted and identified. Once data integrity is assured, the selection of data for the VSD process can begin.

Data selection will include a study of the relative severity of multiple configurations and a determination of how the configurations will be weighted during development. The multiple events are studied to determine how they should be grouped. Due to several factors, it is often unwise to combine all events into a single vibration schedule. Consideration should be given to the linearity of the system. The events are compared, and those with similar ASD shape and level are grouped and processed together. This often results in two or more LVTS to reproduce a system's equivalent fatigue, but produces a more accurate representation of the vibration exposure.

Studies are also conducted to answer questions as to the nature of the data. What bandwidth is required to include the majority of the vibration energy? Is the vibration characterized as Gaussian, or how well can it be replicated by a control system that generates a Gaussian drive signal? Is the energy broadband, or does it contain narrowband energy (e.g., tonal energy induced by a helicopter main rotor)? If narrowband energy is present, is it more sinusoidal or more narrowband random in nature? Often, project specific studies must be conducted before the VSD procedure can begin.

7. SCENARIO DEVELOPMENT.

The expected duration of vibration exposure is derived from the system's mission or lifetime scenario, often provided in the LCEP. A system's mission or lifecycle scenario is a key parameter for a VSD effort. In some cases a number of mission types are required, each with differing proportions of terrain or maneuvers utilized. These must all be weighted appropriately depending upon the user requirement/LCEP and used in the generation of the vibration schedule. As a minimum, the scenario for a ground vehicle must provide terrain type, average and maximum speeds associated with each terrain type, and total distance traveled on each terrain type. For an aircraft, the scenario must provide a detailed description of all flight conditions, including hover, forward level flight, take-off/ landing and other and relevant maneuvers. The description should include the percentage of flight duration represented by each condition and the number of repetitions for each maneuver.

7.1 Ground Vehicle.

Often, scenario information in the form required for the VSD process is not available. This is particularly true for vehicles not yet in the DoD inventory. If no information is available the scenario information may be inferred by the intended usage. For cargo items, the ground distance is determined based upon transport distance between each of the designated supply points that extend from the depot through the Port Staging Area (PSA) to the user of the item. For installed equipment items, the ground distance is determined on the basis of the maintenance schedule for the

MIL-STD-810H
METHOD 514.8, ANNEX F

vehicle on which the equipment is mounted or on the basis of designer/user agreed upon repair/replacement schedule for the particular installed equipment item.

Often, limited scenario information can be found in the vehicles LCEP or other documentation. This information typically includes overall terrain type distance percentages and sometimes includes total distance and maximum and/or average speed information. Extensive manipulation is often required to distribute the total distance into the various road surfaces and speeds that characterize the vehicles usage. This process is illustrated in Table 514.8F-I.

The Level 1 breakout of Table 514.8F-I contains the minimum scenario information required for a VSD. The Level 2 breakout is a distribution of the general terrain type mileage into the various test surfaces for which data is typically acquired. All surfaces likely to be encountered for a given terrain type should be included in the Level 2 breakout. Surfaces used for Department of Defense (DoD) projects should be similar to those listed in Table 514.8F-I and described in reference r. Level 2 breakout information is rarely available and is typically derived through discussion between the analyst, the user, and other interested parties.

MIL-STD-810H
METHOD 514.8, ANNEX F

Table 514.8F-I: Lifetime Scenario Breakout – Example Only

LEVEL 1 BREAKOUT					LEVEL 2 BREAKOUT				
TOTAL MILES:	1000								
			Max	Avg				Max	Avg
Terrain Type	Percent	Miles	Speed	Speed	Surface¹	Percent	Miles	Speed	Speed
PRIMARY ROAD	70%	700	55	35	Paved	100%	700	55	35
						100%	700		
SECONDARY ROAD	20%	200	40	22	Secondary Road	60%	120	40	25
					Gravel Road	23%	46	45	22
					Belgian Block	10%	20	25	15
					Embedded Rock	1%	2	10	7
					Radial Washboard	3%	6	15	9
					2" Washboard	3%	6	10	7
						100%	200		
* Off Road	10%	100	25	14	Cross Country	85%	85	25	16.3
* A combination of trails and cross country					Embedded Rock	5%	5	10	7
					Radial Washboard	5%	5	15	9
					2" Washboard	5%	5	10	7
						100%	100		
LEVEL 1	This information should be provided by the program manager and is required before LVTS development can begin. This information can sometimes be found in the LCEP or other system documentation.								
LEVEL 2	This breakout has a significant impact on the test durations of the final LVTS and should therefore be given serious consideration. This information, too, should be provided but is seldom available. Development cannot begin without this breakout. Often the analyst is forced to recommend a breakout for the concurrence of user.								

¹ Surfaces are described in Annex F, Appendix F, reference r

MIL-STD-810H
METHOD 514.8, ANNEX F

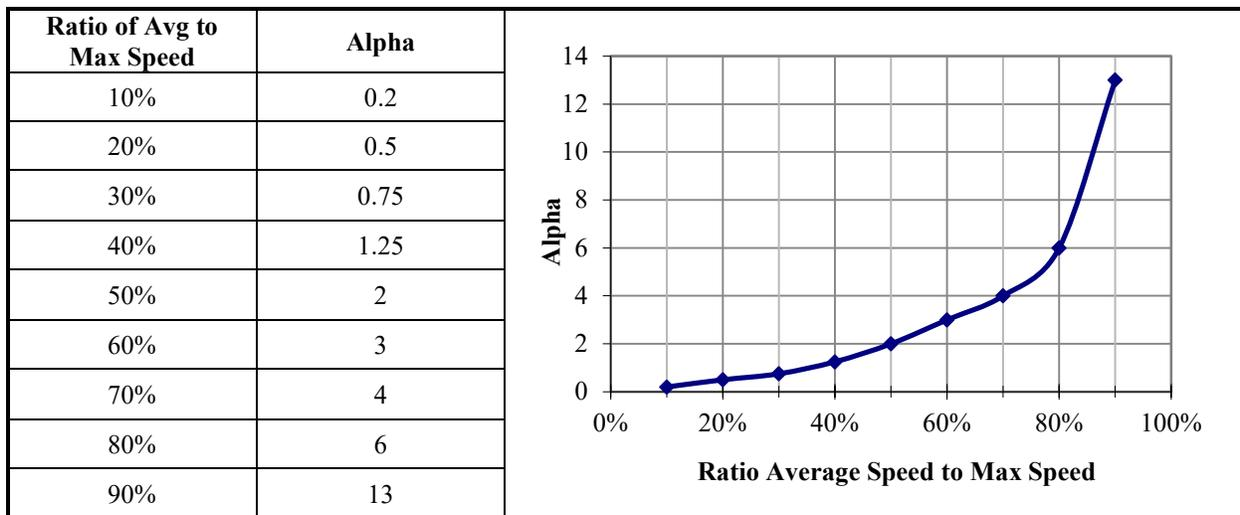
7.1.1 Beta Distribution.

Once consensus is reached on the Level 2 breakout, the distance must be further distributed into the various speeds for which data was acquired. This additional level of fidelity is rarely provided. One option is to utilize the Beta distribution to distribute surface distance into the speed events for that surface. The Beta is a probability distribution with two shaping parameters, α and β , calculated as defined in equation 7.1 where x is the normalized distribution range.

$$f(x) = \frac{(\alpha + \beta - 1)!}{(\alpha - 1)! (\beta - 1)!} x^{\alpha-1} (1-x)^{\beta-1} \quad (7.1)$$

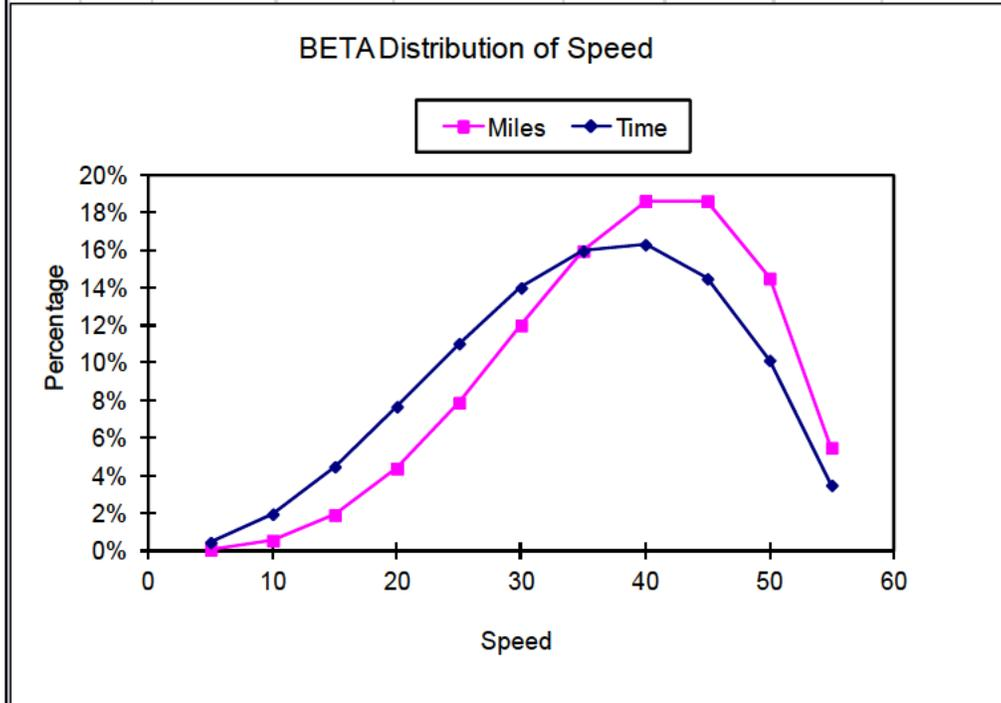
Guidelines have been established to allow consistent selection of α and β , based on the ratio of the average to maximum speed. Alpha can be selected from Table 514.8F-II. Beta is iteratively calculated to yield a calculated average speed from the Beta distribution results to match the average speed provided in the scenario. The Beta distribution should be utilized to distribute the distance into a set of speed ranges, rather than into a set of discrete speeds. An alternative to distributing the total distance is to distribute the total time, based on the total distance and average speed. A Beta distribution is produced for each road surface utilizing a spreadsheet. An example Beta distribution spreadsheet is provided in Figure 514.8F-1.

Table 514.8F-II: Selection of Alpha for Beta Distribution



MIL-STD-810H
METHOD 514.8, ANNEX F

BETA DISTRIBUTION INPUTS		CALCULATED RESULTS	
SURFACE	Paved Road	Dist Min Speed	0
MIN SPEED OF DATA SET	5	Dist Max Speed	57.5
MAX SPEED OF DATA SET	55	ALPHA	3.40
AVG SPEED FROM SCENARIO	35	BETA	2.19
SPEED INCREMENT OF DATA SET	5	Average Speed	35.00
TOTAL MILES FROM SCENARIO	700.00	Total Miles	699.982
TOTAL HOURS	20.000	Total Hours	20.000
Ratio Avg/Max Speed	64%	Error	0.00%



BETA DISTRIBUTION OF SPEED								
Repr Speed	Start Speed	End Speed	Range Avg	Percentage Time	Time in Hours	Time in Min.	Miles	Percentage Miles
n/a	0	2.5	1.25	0.012%	0.002	0.15	0.0031	0.00%
5	2.5	7.5	5	0.458%	0.092	5.50	0.46	0.07%
10	7.5	12.5	10	1.966%	0.393	23.59	3.93	0.56%
15	12.5	17.5	15	4.487%	0.897	53.84	13.46	1.92%
20	17.5	22.5	20	7.673%	1.535	92.08	30.69	4.38%
25	22.5	27.5	25	11.035%	2.207	132.42	55.18	7.88%
30	27.5	32.5	30	13.999%	2.800	167.99	84.00	12.00%
35	32.5	37.5	35	15.955%	3.191	191.46	111.68	15.95%
40	37.5	42.5	40	16.295%	3.259	195.54	130.36	18.62%
45	42.5	47.5	45	14.478%	2.896	173.74	130.31	18.62%
50	47.5	52.5	50	10.142%	2.028	121.71	101.42	14.49%
55	52.5	57.5	55	3.499%	0.700	41.99	38.49	5.50%
TOTAL				100.0%	20.000	1200.00	699.982	100.0%
TOTAL USED				100.0%	19.998	1199.85	699.979	100.0%

Figure 514.8F-1. Sample beta distribution (wheeled vehicle).

MIL-STD-810H
METHOD 514.8, ANNEX F

The Beta distribution calculations are performed in the “BETA DISTRIBUTION OF SPEED” table of Figure 514.8F-1. A description of the fields follows.

- a. Repr Speed - The representative speed for this entry. This is the speed for which vibration data were acquired.
- b. Start Speed – The beginning of the speed range for this entry.
- c. End Speed – The ending of the speed range for this entry.
- d. Range Average – The average of the speed range for this entry. This number should be equal to the representative speed for the entry.
- e. Percentage Time – This is the actual Beta distribution as a percentage of the total drive time. This column, along with the Percentage Miles column, is plotted on the graph of Figure 514.8F-1.
- f. Time in Hours – The time in hours represented by this data entry, calculated by multiplying the total hours by the percentages of the previous column. The total hours is calculated from the total miles and the average speed.
- g. Time in Min. – The time in minutes represented by this data entry. This is the final output of the Beta distribution and is passed forward to the VSD process.
- h. Miles – The miles represented by this data entry, calculated by multiplying the Time in Hours by the Range Average.
- i. Percentage Miles – The percentage of the total miles represented by this entry. This column, along with the Percentage Time column, is plotted on the graph of Figure 514.8F-1.

Note that the widths (in units of speed) of each speed range in the table of Figure 514.8F-1 are equal to the speed increment for which data was acquired and are centered around the acquired speeds. This results in two slight inconsistencies at the endpoints of the Beta distribution. First, the percentage of the miles at very low speeds (below 2.5 mph in this example) is not included in the VSD process. It is expected that the vibration at these speeds will be quite low and have no effect on the resultant LVTS, even if included. Second, the maximum speed of the Beta distribution is one-half speed increment higher than the highest speed for which data was acquired. This too should have little effect on the VSD process since very little time is spent at this speed.

The endpoints of the Beta distribution technique are treated slightly different for NBROR or SOR LVTS. In those cases, the endpoints for Beta distribution are set to exactly the minimum and maximum speeds acquired. If the example presented here were for a tracked vehicle the range of the first entry would be from 5 to 7.5 mph instead of 2.5 to 7.5 mph. Likewise, the last entry would be from 42.5 to 45 mph instead of 42.5 to 47.5 mph. For a tracked vehicle the narrowband random sweeps dominate the fatigue exposure represented by an LVTS. The same is true for the swept sine LVTS. Therefore, more emphasis is placed on the sweep ranges when calculating the Beta distribution. The sweep ranges are bound by the frequencies associated with the minimum and maximum speeds acquired, and the Beta distribution ranges are selected to account for that. Note that the speed ranges of the endpoints are then one-half as wide as the intermediate points. This is accounted for in the VSD process when calculating the actual run time represented by each speed event. The run times of the first and last speeds are set to one half of the intermediate speeds. Note also that during testing on the shaker, the swept narrow bands are in the range of the endpoint speeds for one-half the time of the other speeds.

7.2 Aircraft.

The scenario for cargo and installed equipment transported by aircraft is generally measured in time rather than distance. The time begins with the standby-engine running phase and progresses through ascent, level flight, maneuvers, and ends with descent and landing. It is imperative that the scenario information for a given aircraft provides sufficient flight conditions to adequately describe the most severe vibration environment. For example, level flight should include a range of speeds between minimum and maximum in order to determine the most severe level flight condition. In addition, the number of flights must be known so that the laboratory test time can be determined.

Detailed scenario information is generally more readily available for aircraft than for ground vehicles in the form of usage spectrums. A usage spectrum is a tabulation of the percentage of flight time associated with all maneuvers relevant for the aircraft. This information feeds directly into the tables required for VSD. Generally, the only manipulation required is to combine the usage of the extensive list of maneuvers included in an aircraft’s usage

MIL-STD-810H
METHOD 514.8, ANNEX F

spectrum into the relatively few maneuvers for which data is typically acquired. During the data acquisition phase, it is typically not feasible to acquire data for all the maneuvers in an aircraft's usage spectrum. Engineering judgment is exercised when selecting a representative set of maneuvers for which data is acquired, although it is common practice to explore the limits of the allowable aircraft flight envelope (altitude, speed, angle of attack, throttle variations, acceleration etc.) plus enough information to allow extrapolation/interpolation to cover other events. Likewise, the flight time percentages of all maneuvers in the usage spectrum must be distributed into the maneuvers for which data was acquired. This analysis should rely on sources knowledgeable of aircraft usage to assist in scenario development.

7.3 Sea Vehicle.

Material installed aboard naval ships is subjected to varying frequencies and amplitudes of environmental vibration for extended periods of time, during which they are required to perform their normal function. Principal causes of steady state shipboard vibration are propeller blade excitation and unbalanced forces of the propeller and shafting. Vibrations are also experienced by shipboard mounted equipment caused by mounting system resonances, changes in ship speed and heading, and changes in sea state.

Equipment integrated onto a ship will generally have a much longer service life than that of cargo. For either case, one would expect the LCEP to consist of the number of hours at sea subdivided into various sea states. If an exact breakdown of sea states is not provided, an experienced analyst may take advantage of the Beta distribution techniques discussed in the previous section as a method of refining the LCEP.

7.4 Rail Transport.

Material installed on railcars is primarily subjected to low level broadband vibration affected primarily by the railcar speed. There are no surface considerations. If an exact breakdown of speeds is not provided, an experienced analyst may take advantage of the Beta distribution techniques discussed in the previous section as a method of refining the LCEP.

8. VSD ALTERNATIVES.

As discussed in Annex F, paragraph 4, data classifications for a VSD effort will be either sinusoidal, random, or a combination thereof. In the case of random data, there is an underlying assumption of stationarity and Gaussian probability density function characteristics. For cases in which the field data is clearly not stationary or not Gaussian, alternatives to the VSD techniques discussed in this document should be investigated. Techniques such as Time Waveform Replication (TWR), consists of the replication of either measured or analytically specified time trace(s) in the laboratory. TWR is a statistically non-parametric technique in which both spectral and temporal characteristics are preserved. For more information about TWR refer to Method 525.2.

9. VSD PROCEDURES.

9.1 VSD Considerations.

The VSD process will depend on several factors, including the vibration environment, system goals, value of the hardware, system fragility, test schedule constraints, test lab capabilities, and other considerations. Independent of the methods utilized, the results must define the vibration in laboratory testable terms and include a definition of the vibration levels and test exposure times.

The objective in the VSD effort outlined in Annex F, Appendix D, as opposed to a simple statistical combination of spectra exercise, is development of both a spectral reference and associated test time. As stated above in Annex F, paragraph 1, time compression techniques based on fatigue equivalency are typically employed such that vibration testing can be performed in a timely and economic manner. However, regardless of the VSD technique employed, one would expect the spectral shape of the final product to be similar to that of the field data used as the basis for the development. As a sanity check, one may wish to compare the spectral shape resulting from a VSD development to a basic statistical summary of the uncompressed reference data. Annex F, Appendix B provides a basic discussion on the topic of statistical combination of data that often proves useful in reviewing VSD spectral results. Annex F, Appendix C provides a discussion of combination of data from a Fatigue Damage Spectrum (FDS) perspective.

MIL-STD-810H
METHOD 514.8, ANNEX F**9.2 Engineering Data Common Across VSD Methods.**

The Handbook for Dynamic Data Acquisition and Analysis (reference I) provides a wealth of signal analysis techniques and overall data acquisition guidance and is recommended as a key reference in the VSD process. A few of the most common analysis definitions utilized in VSD efforts are provided in Annex F, Appendix B.

9.2.1 Miner-Palmgren Hypothesis.

In the simplest terms, the Miner-Palmgren Hypothesis (Miner's rule) is a set of mathematical equations used to scale vibration spectra levels and their associated test times. It provides a convenient means to analyze fatigue damage resulting from cyclical stressing. Miner's rule, originally based on empirical data, establishes a relationship between the ratio of the number of cycles at a given stress level to the number of cycles at another stress level.

The major cause of items failing to perform their intended function is material fatigue and wear accumulated over a time period as a result of vibration-induced stress. It is preferable for materiel to be tested in real-time so the effects of in-service conditions are simulated most effectively. However, in most instances real-time testing cannot be justified based on cost and/or schedule constraints and, therefore, it is customary to compress the service life environment into an equivalent laboratory test. For vibration environments that vary in severity during the materiel's service life, the duration of the environment can often be reduced for testing by scaling the less severe segments of the vibration environment to the maximum levels of the environment by use of an acceptable algorithm.

In many cases, scaling less severe segments to the maximum levels may still yield a test duration that is still too long to be practical. In such cases, the same algorithm may be used to further reduce test duration by further increasing the test amplitude. Provided that fatigue is a significant potential failure criterion for the materiel under test, this practice is acceptable within strict limits, notably that test amplitudes are not over exaggerated (or accelerated) simply to achieve short test durations. Such excessive amplitudes may lead to wholly unrepresentative failures, and cause suppliers to design materiel to withstand arbitrary tests rather than the in-service conditions. Conversely, overly extending test durations in order to excessively reduce the amplitude may result in the test article passing vibration testing in the laboratory but experience vibration related failures in the field.

While the use of Miner's rule is based upon fatigue damage being the principal failure mechanism, it has been found historically that test durations calculated by this means tend to be somewhat conservative when considering other failure mechanisms such as fretting and other types of wear. However, when considering the wide range of dynamic forcing functions considered over the life cycle of most hardware, test durations calculated using Miner's rule have proven to be generally acceptable regardless of the failure mechanism under consideration.

9.2.1.1 S/N Curve.

Graphically, the relationship of stress to number of cycles can be depicted as shown in Figure 514.8F-2. Figure 514.8F-2 relates stress (S) to the number of cycles (N) and is an example of a plot commonly referred to as the S/N curve. The black curve of Figure 514.8F-2 is the theoretical relationship of stress and the number of cycles. The red curve is a linearized representation of the black curve. Note that the number of cycles increases as the stress level decreases. At point A on the curve the stress level is so high that fatigue failure will result from any number of cycles. At point B on the curve, commonly referred to as the endurance limit, the stress level is so low that an infinite number of cycles will induce no fatigue damage. Between points A and B is the region of interest for Miner's rule calculations.

MIL-STD-810H
METHOD 514.8, ANNEX F

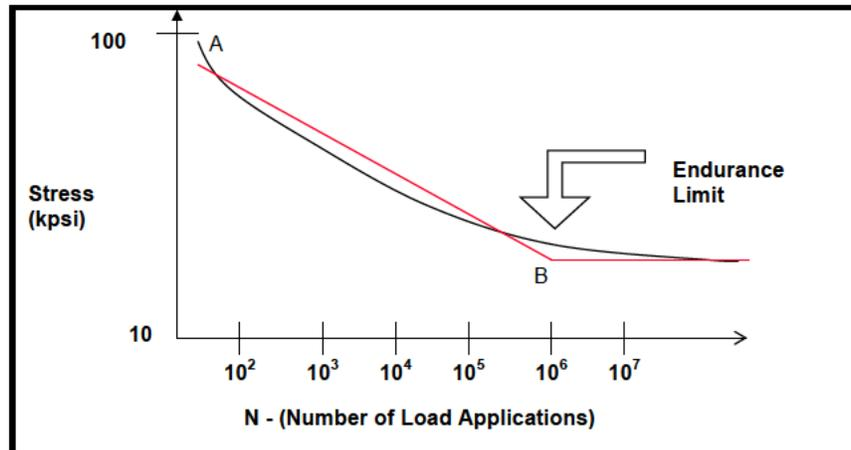


Figure 514.8F-2. S/N curve.

9.2.1.2 Miner-Palmgren Equations.

The most commonly used method for calculating a reduction in test duration is the Miner-Palmgren hypothesis that uses a fatigue-based power law relationship to relate exposure time and amplitude. The mathematical expression and variable descriptions for this technique are illustrated below in Equations (9.1) and (9.5).

$$\frac{t_2}{t_1} = \left[\frac{S_1}{S_2} \right]^m \quad (9.1)$$

where:

t_1 = equivalent test time

t_2 = in-service time for specified condition

S_1 = severity (rms) at test condition

S_2 = severity (rms) at in-service condition

[The ratio S_1/S_2 is commonly known as the exaggeration factor.]

m = a value based on (but not equal to) the slope of the S/N curve for the appropriate material where S represents the stress amplitude and N represents the mean number of constant amplitude load applications expected to cause failure.

In practice, vibration test amplitudes and durations need to be rescaled without knowledge of the original in-service condition (S_2). Equation 9.2 is the generalized relationship for rescaling sine tone test amplitudes based on the original time compression and new time compression.

$$S_{1new} = S_1 \left(\frac{t_1 t_{2new}}{t_2 t_{1new}} \right)^{\frac{1}{m_s}} \quad (9.2)$$

where:

t_1 = original test time

t_2 = original in-service time used to develop test

S_1 = original test levels

$m_s = 6$ (Historical material exponent for sinusoidal vibration, see Annex A, paragraph 2.2. The same material exponent value should be used when rescaling as used during the initial compression.)

t_{1new} = new test time

t_{2new} = new in-service time on LCEP

S_{1new} = rescaled test levels based on LCEP

MIL-STD-810H
METHOD 514.8, ANNEX F

Fatigue damage can be calculated using either a stress life or strain life process. Although most engineering structures are designed such that the nominal loads remain elastic, it is important to acknowledge that stress concentrations often cause plastic strains to develop in the vicinity of notches. Figure 514.8F-3 illustrates the total strain as a sum of plastic and elastic components of strain (reference o).

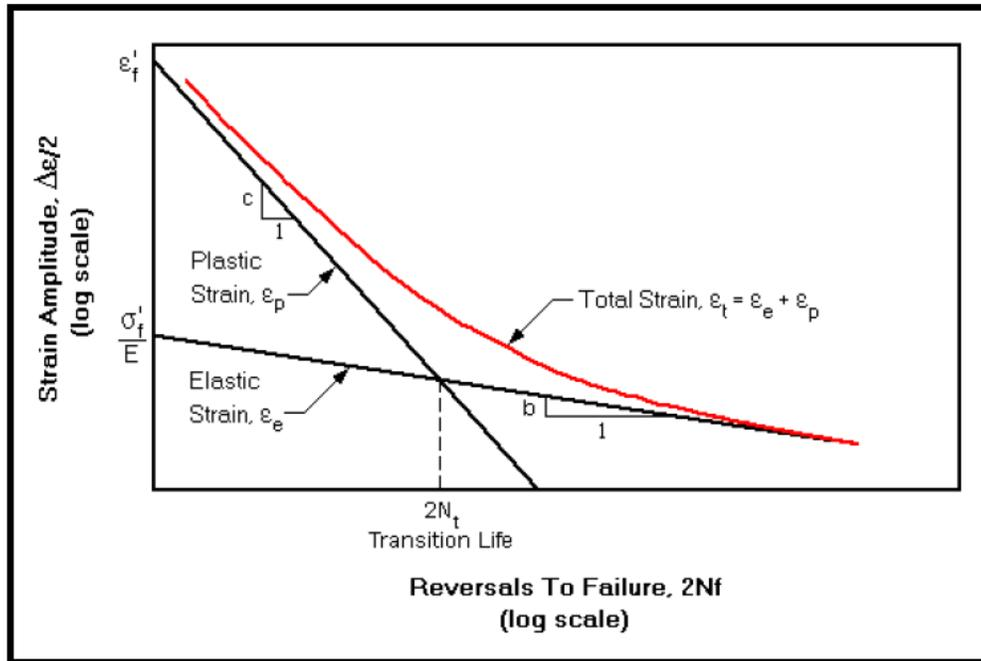


Figure 514.8F-3. Typical strain life curve.

For the strain life technique (assuming zero static load), the number of cycles to failure, N_f , is computed from:

$$\varepsilon_a = \frac{\sigma'_f}{E} (2N_f)^b + \varepsilon'_f (2N_f)^c \quad (9.3)$$

where:

ε_a = test or environment strain amplitude

σ'_f = fatigue strength coefficient (material property)

E = modulus of elasticity (material property)

N_f = number of cycles to failure

b = fatigue strength exponent (material property)

ε'_f = fatigue ductility coefficient (material property)

C = fatigue ductility exponent (material property)

In equation 9.3, $\frac{\sigma'_f}{E} (2N_f)^b$, represents elastic components on the strain-life, while $\varepsilon'_f (2N_f)^c$, represents the plastic components. In the event a static load is present, Equation 9.3 may need to be compensated using techniques such as the Smith-Topper-Watson mean stress correction (reference n).

The transition life, $2N_t$, represents the life at which the elastic and plastic strain ranges are equivalent. The transition point of the two components of strain can be computed as:

MIL-STD-810H
METHOD 514.8, ANNEX F

$$2N_t = \left[\varepsilon'_f E / \sigma'_f \right]^{1/(b-c)} \quad (9.4)$$

As shown in Figure 514.8F-3, the transition life provides a convenient delineation between low and high-cycle fatigue. Plastic strains have greater influence below the transition life and Elastic strains have a greater influence above the transition life. For long fatigue lives, the strain-life approach will essentially approach the stress-life approach.

The value of m in Equation 9.1 is strongly influenced by the material S/N curve, but fatigue life is also influenced by the surface finish, the treatment, the effect of mean stress correction. Figure 514.8F-4 graphically depicts the effects of finishing options on SAE-8630 steel to illustrate influence of surface finish on parameter m .

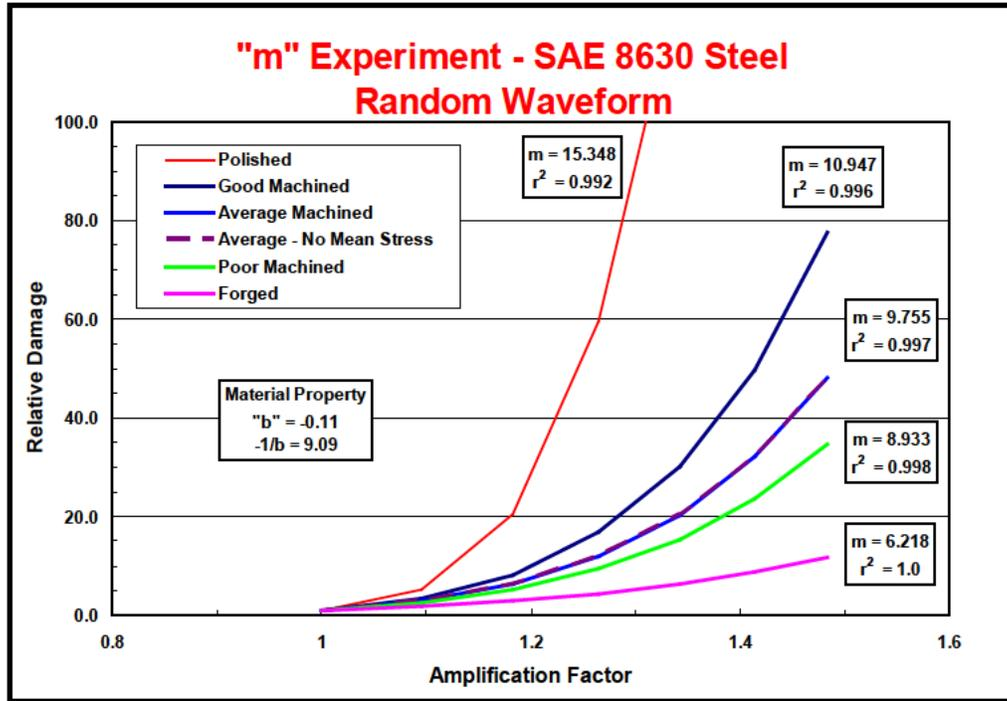
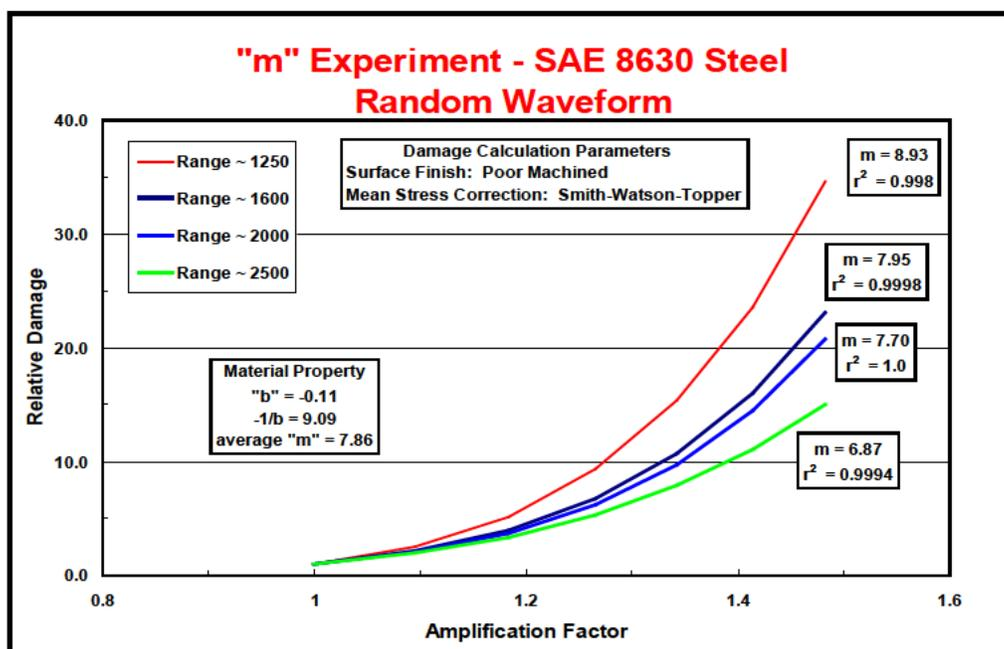


Figure 514.8F-4. Relative damage as a function of surface finish – SAE-8630 steel.

The combined contributions of elastic and plastic strain, and the waveshape of the strain time history, will also influence the value of m . Using SAE-8630 steel as an example, Figure 514.8F-5 graphically depicts the influence of the plastic component of strain on parameter m as strain levels approach the transition point.

MIL-STD-810H
METHOD 514.8, ANNEX F



As a result of multiple factors such as finishing and actual strain levels, the value of m is generally some proportion of the slope of the S/N curve, known as the fatigue strength exponent and designated as b . Typical values of m are 80 percent of $1/b$ for random waveshapes, and 70 percent of $1/b$ for sinusoidal waveshapes.

Historically, values of m between 5 and 8 are commonly used when addressing random environments. A value in the range of 6 is commonly used for sinusoidal environments (references b, h and p).

The basis for the default recommendations in Table 514.8F-III may be traced to historical success of m selections within the range suggested in Table 514.8F-III, combined with investigating the properties of a wide range of steel and aluminum alloys as discussed in reference n. Reference n summarizes a strain analysis that was conducted on an ensemble of commonly used steels and aluminum alloys in which strain levels approaching the transition life were considered. Strain levels in the analytical investigation of reference n were controlled such that the minimum number of cycles to failure was generally greater than 10,000. Multiple finishing processes were considered as well. The default values in Table 514.8F-III have been separated into families of steel and aluminum alloys to add some fidelity in the selection of m . Observe that historical values of 5-8 fall within the range of m defined in Table 514.8F-III, providing an additional level of confidence between the historical values used for m and the recent analytical study of reference n.

Table 514.8F-III. Default Values for m

Excitation Type	m – (Default Value) (Steels)	m – (Default Value) (Aluminum Alloys)
Sinusoidal	5.75	8.5
Random	7	9

MIL-STD-810H
METHOD 514.8, ANNEX F

When addressing a LVTS for a simple test article whose design consists of a single material, one could simply look up the value of b directly, and compute m as a percentage (70-80 percent) of the inverse of b as discussed above. The difficulty common to most LVTS development efforts of complex systems is that more than one material comprises the system design. In such cases, default values for parameter m are recommended per Table 514.8F-III. If the exact composition of a complex structure is not known, it is recommended that the more conservative selections for m based on steel are selected.

The cumulative damage assumption is based on the fatigue properties of metals. The Shock and Vibration Handbook, chapter 35 (reference d), recommends that Miner's cumulative damage theory not be used for composite materials. However, a "wearout model," defined as "the deterioration of a composite structure to the point where it can no longer fulfill its intended purpose," is shown as a power law model in the form of Equation (9.1) with variable exponents dependent upon the type of composite system. It is recommended that test time compression for composite structures be treated on a case-by-case basis.

Since most vibration environments are expressed in terms of the auto spectral density function, Equation (9.1) can also be formulated as:

$$\frac{t_2}{t_1} = \left[\frac{W(f)_1}{W(f)_2} \right]^{\frac{m}{2}} \quad (9.5)$$

where:

t_1 = equivalent test time

t_2 = in-service time for specified condition

$W(f)_1$ = ASD at test condition, g^2/Hz

$W(f)_2$ = ASD at in-service condition, g^2/Hz

[The ratio $W(f)_1/W(f)_2$ is commonly known as the exaggeration factor]

m = as stated in Equation (9.1)

The ratio of $W(f)_2$ to $W(f)_1$ becomes the exaggeration factor. For factors greater than 1, the laboratory test time is reduced and conversely, for factors less than 1, the test time is increased.

In practice, vibration test amplitudes and durations need to be rescaled without knowledge of the original in-service condition $W(f)_2$. Equation 9.6 is the generalized relationship for rescaling the random broadband background based on the original time compression and the new time compression.

$$W(f)_{1new} = W(f)_1 \left(\frac{t_1 t_{2new}}{t_2 t_{1new}} \right)^{\frac{2}{m_R}} \quad (9.6)$$

where:

t_1 = original test time

t_2 = original in-service time

$W(f)_1$ = original test levels

$m_R = 7.5$ (Historical materiel exponent for random vibration, see Annex A, paragraph 2.2. The same material exponent value should be used when rescaling as used during the initial compression.)

t_{1new} = new test time

t_{2new} = new in-service time

$W(f)_{1new}$ = rescaled test levels based on LCEP

Selection of exponent m does not give complete freedom to the use of equations (9.1) and (9.5) in compressing test times! Caution must be exercised in using the exaggeration factor. It appears foolish to attempt to compress test time so that

MIL-STD-810H
METHOD 514.8, ANNEX F

increased amplitude will exceed the yield or ultimate strength of the material. Reference h, suggests limiting the exaggeration of test levels so as not to exceed the ratio of ultimate strength to endurance strength of the material being tested. In an attempt to determine a value for the maximum exaggeration factor, a search was conducted of the mechanical properties of 25 metals that have been used most often in a large variety of test items (reference i).

The ratios of ultimate stress (U) to the elastic limit (Y) and ultimate stress (U) to the endurance limit (EN) were calculated for each of the metals and averaged, producing values of $U/Y = 1.37$ and $U/EN = 2.78$. These ratios were then averaged, producing a value of 2.08 (see Table 514.8F-IV). The value of 2 is therefore suggested as the maximum limit for exaggeration factors.

Table 514.8F-IV. Metals and Material Properties.

	ELASTIC ENDURANCE				
	LIMIT (Y)	LIMIT (EN)	ULTIMATE (U)	RATIO (U/Y)	RATIO (U/EN)
Steel, 0.4% C, h. rolled	53	38	84	1.59	2.21
Steel, stainless (18-8) annealed	36	40	85	2.36	2.13
Steel, stainless (18-8) cold rolled	165	90	190	1.15	2.11
Alum, cast, 195T-6	24	7	36	1.33	5.14
Alum, wrought, 2014-T4	41	18	62	1.51	3.44
Alum, wrought, 2024-T4	48	18	68	1.42	3.78
Alum, wrought, 6061-T6	40	13.5	45	1.13	3.33
Magnesium, extrusion, AZ80X	35	19	49	1.40	2.58
Magnesium, sand cast, AZ63-HT	14	14	40	1.00	2.86
Monel, wrought, hot rolled	50	40	90	1.80	2.25
Steel, 1040	60	43	90	1.50	2.09
Steel, 1340	63	59	102	1.62	1.73
Steel, 4130	63	47	97	1.54	2.06
Steel, 4140	143	66	165	1.15	2.50
Steel, 4340	200	68	222	1.11	3.27
Steel, 5140	169	82	190	1.12	2.32
Steel, HY140	142	70	149	1.05	2.13
Steel, Marage 200	215	100	225	1.05	2.25
Steel, Marage 350	345	110	352	1.02	3.20
Alum, cast, 113	15	9	24	1.60	2.67
Alum, cast, 335, T61	35	10	39	1.11	3.90
Alum, cast, 224, T7	48	12	61	1.27	1.27
Alum, cast, A249, T7	50	11	60	1.20	5.46
Cast iron, malleable	33	28	58	1.76	2.07
Cast iron, ductile	55	30.5	80	1.46	2.62
Average $U/Y = 1.37$					
Average $U/EN = 2.78$					
Average $\frac{U/Y + U/EN}{2} = 2.08$					

This approach is based upon a combination of experience and some valid assumptions. Experience has shown that equipment is designed so that its structural integrity lies above the endurance limit of the material because fatigue failures occur in the field. Items are not designed at the ultimate limit of the material, however, because these failures do not occur on the first vibration cycle.

Assuming that equipment is designed so that its structural characteristics lie somewhere in the midpoint region between the endurance and elastic limits (see Figure 514.8F-6), splitting the approximate difference would produce a value of 2 which thus lends credence to the use of 2 as the maximum exaggeration factor. The value of 2 as a maximum exaggeration factor applies to the definition of exaggeration factor of equation 9.1 above (S_1/S_2). It would follow that because the values in equation 9.5 (W_1/W_2) are squared values with respect the equation 9.1 that the maximum exaggeration factor of equation 9.5 would be 4. However in some cases large exaggeration factors can lead to controllability issues on vibration exciters.

MIL-STD-810H
METHOD 514.8, ANNEX F

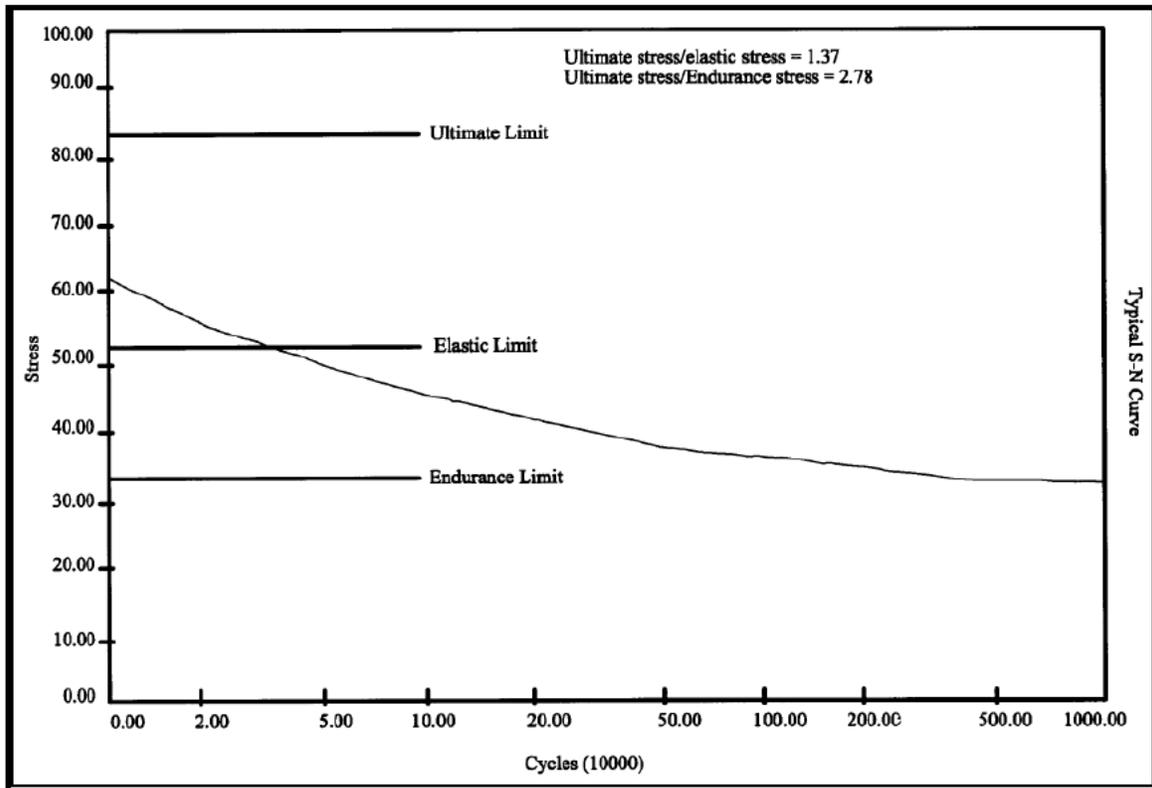


Figure 515.8F-6. Typical S/N curve.

Exaggeration factors for materials whose fatigue characteristics are unknown or for failure mechanisms other than fatigue (such as loosening of threaded connections) cannot be calculated. However, when considering the wide range of dynamic forcing functions considered over the life cycle of most hardware, test durations calculated using Miner's rule have proven to be generally acceptable regardless of the failure mechanism under consideration.

Miner's rule, as with any analysis method, is not without its shortcomings. The text "Shock and Vibration Handbook", fourth Edition, C Harris, 1996, identifies two shortcomings. In reference to Miner's rule the text states, "... it does not consider the sequence of loading and assumes that damage in any individual stress cycle is independent of what has preceded it. Furthermore, it assumes that damage accumulation is independent of stress amplitude." However, the same text refers to Miner's rule as "the most commonly applied linear damage rule". Its acceptance in the vibration community certainly supports Harris's assertion. The use of Miner's rule for VSD is recommended by many national and international documents. However, care should be taken to assure that Miner's rule is applied properly and with an understanding of its limitations.

10. PREDICTIONS OF MAXIMUM RESPONSE.

Subsequent to development of the LVTS, it is generally of interest to analyze response dynamics of the unit under test (UUT) prior to conducting a laboratory test. In the absence of a detailed mechanical model of the UUT, one might consider use of the Maximum Response Spectrum (MRS) model. The basic concept of MRS analysis and defining mathematics are detailed in Annex F, Appendix E. In the event maximum response levels exceed design targets, it is recommended that a thorough review of both the LVTS variables and details of the design targets be conducted prior to initiating the laboratory test.

MIL-STD-810H
METHOD 514.8, ANNEX F

11. SUMMARY AND CONCLUSION.

LVTS development methods will continue to evolve. This evolution could result from improvements in vibration control systems, or from the results of on-going analysis studies. For example, the ability to simultaneously test in multiple axes, and the ability of modern control systems to account for non-Gaussian skewness and kurtosis will eventually affect LVTS development. The methods and procedures presented in this document are intended as guidelines, with the understanding that project specific tailoring may be required, and that new methods may be incorporated as they become available. Information on the development of multiple axis LVTS can be found in Method 527.2.

MIL-STD-810H
METHOD 514.8, ANNEX F, APPENDIX A**METHOD 514.8, ANNEX F, APPENDIX A**
Preparation for VSD - Data Acquisition**1. INTRODUCTION.**

VSD requires full characterization of system vibration exposure. The characterization typically includes a collection of vibration time histories of all relevant exposure conditions, and a table of exposure times for those conditions. This Appendix presents general information relative to the acquisition and preparation of the time histories, and the generation of the exposure time table (system scenario).

2. VEHICLE PREPARATION FOR DATA ACQUISITION - CARGO.

2.1 Specified Load: If the load and tie-down method are specified, no further instructions are necessary.

2.2 General Cargo Simulated Load: For general applications when loads and tie-down methods are not specified, choose typical cargo packages such as boxes, drums or cartons, designed to provide a simulated load that covers as much of the cargo bed as possible, consistent with the tie-down method. The cargo weight should be approximately 75 percent of the rated payload. This weight limitation is an arbitrary figure based on a study (reference j) in, which load weights were found to vary in the field enough to be unpredictable but tended toward full load. Another study revealed that the severity of the cargo bed vibration environment was minimal at full load and increased dramatically as the load decreased (reference k). The value of 75 percent of rated payload was chosen to provide a degree of conservatism. The analyst should consider the mission scenario carefully to establish the likelihood of lighter loads being carried. If unable to be reasonably sure that light loads will not be carried, some data capture should also be conducted using additional light load conditions and the VSD should utilize data from all load conditions considered.

Large rigid items such as steel plates, beams, concrete blocks, should not be used as simulated loads because their monolithic nature inhibits the flexibility of the cargo bed. In addition loose material such as sand or soil should not be placed directly on to the load bed as this will tend to dampen out any structural resonances present in the load floor.

2.3 Tie-down: The simulated load must be securely attached to the vehicle cargo bed using steel banding, web strapping, and/or dunnage. It must be secure enough to prevent movement between load and bed.

2.4 Accelerometers. Transducers must be mounted on the structural members of the cargo bed at locations that measure the input acceleration forces imparted to the load if an input control strategy is to be employed. If a response control strategy is planned then accelerometers should be mounted on structurally stiff locations at the base of the package or items being transported. The number of locations must be sufficient to describe the cargo bed environment. Care should be taken to avoid placing accelerometers in inappropriate places, i.e., the relatively thin steel plate that comprises most cargo bed surfaces.

3. VEHICLE PREPARATION FOR DATA ACQUISITION - INSTALLED EQUIPMENT.

Accelerometers must be mounted on the vehicle walls, deck, and roof, as well as on brackets and shelves that are integral parts of the vehicle, as close as possible to the point(s) of attachment of the existing/planned installed equipment. The purpose is to measure the vibration environment of the vehicle at the input location(s) of the installed equipment which has the same configuration as the equipment subsequently used as a test item during laboratory testing. For instance, if a piece of equipment is mounted on a bracket in the vehicle and that bracket will not appear as part of the equipment during subsequent laboratory testing, the environment should be measured on the bracket as the input to the equipment.

If a mounting platform exists and the equipment to be installed thereon is not available, use a model of the equipment with the same mass and center of gravity. This ensures that the reaction of the installed equipment will be included in the data recorded at the input to the mounting platform.

In the situation in which the test item is instrumented and may be integrated into the control scheme as such as response control or possibly as a limit location, it is critical that any surrogate hardware employed must have strong dynamic similarity to the tactical hardware. It is recommended that a comprehensive modal test of the surrogate hardware be conducted to ensure proper dynamic response is maintained. In some instances, similarity acceptance criteria may be called out, to which the modal parameters of the surrogate hardware must comply.

The difference between the mechanical impedances of mountings for field-installed and laboratory-installed equipment should be considered, particularly for relatively massive equipment. A comparison of the field and

MIL-STD-810H
METHOD 514.8, ANNEX F, APPENDIX A

laboratory frequency response functions is one method of evaluating this difference, and the use of average, extreme, or response laboratory vibration control techniques is considered a valid approach to minimizing any impedance mismatch.

4. DATA ACQUISITION PROCEDURE.

4.1 Data Acquisition.

There are several commercially available data acquisition systems that are capable of measuring and recording vibration data that would be suitable for VSD. The user needs to insure that the signal conditioning including the filter, sample rate and analog-to-digital converter (ADC) fidelity are acceptable for the measurements being made. For example an 8-pole (48 dB/octave, 160 dB/decade) Butterworth filter would require a sample rate of approximately four times the filter frequency to minimize aliasing.

4.2 Cargo Schedules.

- a. Attach tri-axial accelerometers to the structural members of the cargo bed in order to measure the vibration environment along three mutually perpendicular axes usually noted as vertical (V), transverse (T), and longitudinal (L). Normally, this orientation is relative to the axes of the vehicle, i.e., vertical is up/down, transverse is side/side, and longitudinal is front/rear. This is not mandatory but tends to be least confusing.
- b. Check tie-down.
- c. Insure that instrumentation is working properly and all transducers are calibrated.
- d. Operate the vehicle at the prescribed speed(s) over the designated fixed profile courses, and record the data.

4.3 Installed Equipment Schedules.

- a. Attach tri-axial accelerometers at the actual or proposed vehicle/installed equipment interface to measure input to the equipment as it will subsequently appear as a test item in the laboratory. Orient the accelerometers to measure data in the V, T, and L axes as described in paragraph 4.2 above.
- b. Insure that instrumentation is working properly and all transducers are calibrated.
- c. Operate the vehicle at the prescribed speed(s) over the designated fixed profile courses, and record the data.

5. DATA REQUIRED.

Care must be taken when recording data to ensure that it can be correlated with data taken during previous tests of the same type of vehicle. Parameters such as sampling rate and filtering will affect the ability to compare/combine environments during analysis. The analysis filter bandwidth is particularly important and must be recorded. Comparing/combining different data sets must be done using the same analysis filter bandwidth. Obtain the following:

- a. An accurate log of accelerometer locations and axis orientations.
- b. An accurate log of test courses and speeds.
- c. Recorded data in terms of acceleration amplitudes versus time for time intervals sufficient to ensure accurate analysis.
- d. Graphic representation of the cargo load/installed equipment mounting configuration.
- e. Filter type and cut-off frequency and data sampling rates.

After the data have been acquired it is necessary to insure that the data accurately represent the physical phenomenon that was measured. This can be accomplished by inspecting the data visually and by performing amplitude distributions and other time and frequency domain statistical analysis. There are certain anomalies that need to be identified and corrected before the data can be considered valid. These include but are not limited to outliers (wild points) and shifts in the bias level of a transducer (DC shifts).

Thorough documentation is absolutely critical in all phases of the LVTS development process. During the data acquisition phase, a general list of resources such as vehicle specific serial numbers, identification of all instrumented assets, transducers, data recorders, filters, and software employed shall be included as part of the final report in all

MIL-STD-810H
METHOD 514.8, ANNEX F, APPENDIX A

VSD efforts. A detailed calibration list shall be included for all transducers and signal analysis equipment employed during the data acquisition phase. All user defined parameters such as sampling frequency and filter settings shall also be recorded.

MIL-STD-810H
METHOD 514.8, ANNEX F, APPENDIX A

(This page is intentionally blank.)

MIL-STD-810H
METHOD 514.8, ANNEX F, APPENDIX B

METHOD 514.8, ANNEX F, APPENDIX B
Combination of Spectra (Statistical)

1. COMBINING SPECTRA.

This Appendix provides basic definitions and purely statistical approaches for combining spectra. The techniques discussed in this Appendix, combined with addressing mission scenarios and fatigue equivalence, formulate the basis for the VSD techniques that are discussed in Annex F, Appendixes C and D.

After the scenario is selected and representative data are acquired, it is usually necessary to combine appropriate data into a single descriptor of the environment. For Single-Degree-of-Freedom (SDOF) vibration testing, this descriptor is generally the auto spectral density (ASD) function, a frequency based representation of the measured vibration amplitudes. Multiple-Degree-of-Freedom (MDOF) vibration testing will also require knowledge of the Cross Spectral Density (CSD) properties of motion. Although basic CSD definitions will be discussed, the MDOF VSD case will not be addressed in this Appendix. For further discussion of MDOF techniques refer to Method 527.2.

1.1 Auto and Cross Spectral Densities.

Consider the following basic scalar definitions as presented by Bendat and Piersol (reference e). The discussions assume two stationary (ergodic) Gaussian random processes, $\{x(t)\}$ and $\{y(t)\}$. The finite Fourier Transforms of $\{x(t)\}$ and $\{y(t)\}$ are defined as:

$$X(f) = X(f, T) = \int_0^T x(t) e^{-j2\pi ft} dt$$

$$Y(f) = Y(f, T) = \int_0^T y(t) e^{-j2\pi ft} dt$$

The auto, $G_{xx}(f)$, $G_{yy}(f)$, and cross, $G_{xy}(f)$, spectral densities of $x(t)$ and $y(t)$ for an “unlimited time” length T are defined respectively as:

$$G_{xx}(f) = 2 \lim_{T \rightarrow \infty} \frac{1}{T} E[|X(f, T)|^2]$$

$$G_{yy}(f) = 2 \lim_{T \rightarrow \infty} \frac{1}{T} E[|Y(f, T)|^2]$$

$$G_{xy}(f) = 2 \lim_{T \rightarrow \infty} \frac{1}{T} E[X^*(f)Y(f)]$$

Estimates of $G_{xx}(f)$, $G_{yy}(f)$ and $G_{xy}(f)$ as computed over a “finite time” interval are defined as:

$$\tilde{G}_{xx}(f) = \frac{2}{T} [|X(f, T)|^2]$$

$$\tilde{G}_{yy}(f) = \frac{2}{T} [|Y(f, T)|^2]$$

$$\tilde{G}_{xy}(f) = \frac{2}{T} [X^*(f)Y(f)]$$

MIL-STD-810H
METHOD 514.8, ANNEX F, APPENDIX B

and will have a discrete spectral resolution of $B_e \approx \Delta f = \frac{1}{T}$. There will generally be unacceptably large random error associated with this “raw” estimate. In practice the random error is reduced, by computing n_d different averages of length T to obtain a “smooth” estimate defined as:

$$\begin{aligned}\hat{G}_{xx}(f) &= \frac{2}{n_d T} \sum_{i=1}^{n_d} \left[|X_i(f, T)|^2 \right] \\ \hat{G}_{yy}(f) &= \frac{2}{n_d T} \sum_{i=1}^{n_d} \left[|Y_i(f, T)|^2 \right] \\ \hat{G}_{xy}(f) &= \frac{2}{n_d T} \sum_{i=1}^{n_d} \left[X_i^*(f) Y_i(f) \right]\end{aligned}\tag{B.1}$$

In practice, one will also have to consider the effects of overlapping and windowing options.

1.2 Confidence Interval of ASD Estimates.

During the data collection phase of a VSD effort, every effort will be made to acquire a sufficiently long record of field data to ensure an accurate estimate of the ASD and CSD. In reality, it is not always possible to acquire sufficiently long time histories as to minimize error in the spectral estimates of interest. Given that the number of averages n_d is not a constant for all measurements, one should track the error associated with spectral estimates as they are the basis for the VSD procedures that are the interest of this annex.

As shown in reference e, the sampling distribution for an ASD estimate may be written in terms of the Chi squared distribution as:

$$\frac{\hat{G}_{xx}(f)}{G_{xx}(f)} = \frac{\chi_n^2}{n} \quad n = 2n_d$$

Observe that the number of degrees of freedom $n = 2n_d$ results from the fact that each instantaneous estimate of the complex number $X(f)$ consists of statistically independent real and imaginary components.

Statistical confidence bands can be placed around this estimate of $G_{xx}(f)$ as:

$$\frac{n\hat{G}_{xx}(f)}{\chi_{n; \frac{\alpha}{2}}^2} \leq G_{xx}(f) \leq \frac{n\hat{G}_{xx}(f)}{\chi_{n; 1-\frac{\alpha}{2}}^2}\tag{B.2}$$

where: α defines the confidence interval (i.e., for a 90 percent confidence interval $\alpha = .1$)

Observe that the confidence intervals are strictly related to the accuracy of estimate of $G_{xx}(f)$ and in no manner addresses the scatter within individual spectral bins of the individual averages used to compute $\hat{G}_{xx}(f)$.

MIL-STD-810H
METHOD 514.8, ANNEX F, APPENDIX B

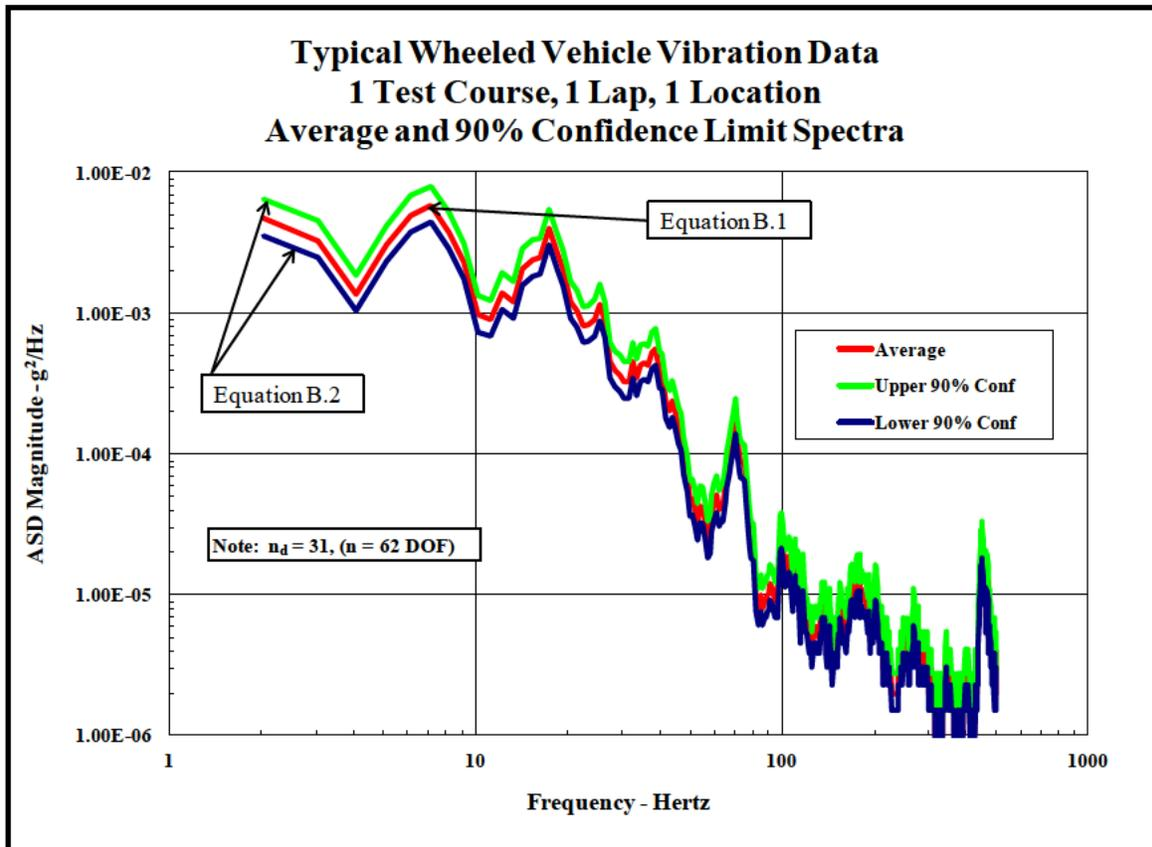


Figure 514.8F-B.1. 90-percent confidence limits for $n_d = 31$ linear spectral averages.

2. STATISTICAL CONSIDERATIONS FOR DEVELOPING LIMITS ON AN ENSEMBLE OF DATA.

This paragraph provides information relative to the statistical characterization of a set of data for the purpose of defining an upper limit of the data set related to statistical/probabilistic considerations. This section is based on the summary of work in reference g and is summarized in Method 516.8, Annex B.

Information in this paragraph is generally applicable to frequency domain estimates that are either predicted based on given information or time domain measurements processed in the frequency domain according to an appropriate technique i.e., for stationary random vibration, the processing would be an ASD; for a very short transient the processing could be a Shock Response Spectrum (SRS), an Energy Spectral Density (ESD), or a Fourier Spectrum (FS). Given estimates in the frequency domain, information in this Appendix will allow the establishment of upper limits of the data in a statistically correct way.

2.1 Basic Estimate Assumptions.

Prediction estimates, measurement estimates, or a combination of prediction and measurement estimates may be considered in the same manner. It is assumed that uncertainty in individual measurements (processing error) does not affect the limit considerations. For measured field data digitally processed such that estimates of the SRS, ESD, FS, or ASD are obtained for single sample records, it is useful to examine and summarize the overall statistics of "similar" estimates selected in a way so as to not bias the summary statistics. To ensure the estimates are not biased, the measurement locations might be chosen randomly, consistent with the measurement objectives. Similar estimates may be defined as (1) estimates at a single location on materiel that has been obtained from repeated testing under essentially identical experimental conditions; (2) estimates on a system that have been obtained from one test, where the estimates are taken (a) at several neighboring locations displaying a degree of response homogeneity or (b) in "zones" i.e., points of similar response at varying locations; or (3) some combination of (1) and (2). In any case, it is assumed that there is a certain degree of homogeneity among the estimates across the frequency band of interest. This

MIL-STD-810H
METHOD 514.8, ANNEX F, APPENDIX B

latter assumption generally requires that (1) the set of estimates for a given frequency have no significant “outliers” that can cause large sample variance estimates, and (2) larger input stimulus to the system from which the measurements are taken implies larger estimate values.

2.2 Basic Estimate Summary Preprocessing.

There are two ways in which summaries may be obtained. The first way is to use an "enveloping" scheme on the basic estimates to arrive at a conservative estimate of the environment, and some qualitative estimate of the spread of basic estimates relative to this envelope. This procedure is dependent upon the judgment of the analyst and, in general, does not provide consistent results among analysts. The second way is to combine the basic estimates in some statistically appropriate way and infer the statistical significance of the estimates based upon probability distribution theory. Reference g summarizes the current state of knowledge relative to this approach and its relationship to determining upper limits on sets of data. In general, the estimates referred to and their statistics are related to the same frequency band over which the processing takes place. Unfortunately, for a given frequency band, the statistics behind the overall set of estimates are not easily accessible because of the unknown distribution function of amplitudes for the frequency band of interest. In most cases the distribution function can be assumed to be normal, provided the individual estimates are transformed to a "normalizing" form by computing the logarithm to the base ten of the estimates. For ESD and FS estimates, the averaging of adjacent components (assumed to be statistically independent) increases the number of degrees of freedom in the estimates while decreasing the frequency resolution with the possible introduction of statistical bias in the estimates. For ASD estimates, averaging of adjacent components can be useful provided the bias error in the estimate is small; i.e., the resolution filter bandwidth is a very small fraction of the overall estimate bandwidth. For SRS estimates, because they are based on maximum response of a single-degree-of-freedom system as its natural frequency is varied, adjacent estimates tend to be statistically dependent and, therefore, not well smoothed by averaging unless the SRS is computed for very narrow frequency spacing. In such cases, smoothing of SRS estimates is better accomplished by reprocessing the original time history data at a broader natural frequency spacing, e.g., 1/6th octave as opposed to 1/12th octave. There is no apparent way to smooth dependent SRS estimates mathematically when reprocessing cannot be performed, and the acceptable alternative is some form of enveloping of the estimates. The larger the sample size, the closer the logarithm transform of the estimates is to the normal distribution unless there is a measurement selection bias error in the experiment. Finally, generally, before application, the upper limits obtained in the paragraphs to follow are smoothed by straight line segments intersecting at spectrum “breakpoints.” No guidance is provided in this appendix relative to this “smoothing” or “enveloping” procedure, e.g., whether estimates should be clipped or enveloped and the relationship of the bandwidth of the estimates to the degree of clipping, etc., except that such smoothing should be performed only by an experienced analyst. Reference g discusses this further.

2.3 Parametric Upper Limit Statistical Estimate Assumptions.

In all the formulas for the estimate of the statistical upper limit of a set of N predictions or measurements,

$$\{x_1, x_2, \dots, x_N\}$$

it is assumed that (1) the estimates will be logarithm transformed to bring the overall set of measurements closer to those sampled of a normal distribution and (2) the measurement selection bias error is negligible. Since the normal and “t” distribution are symmetric, the formulas below apply for the lower bound by changing the sign between the mean and the standard deviation quantity to minus. It is assumed here that all estimates are at a single frequency or for a single bandwidth, and that estimates among bandwidths are independent so that each bandwidth under consideration may be processed individually, and the results summarized on one plot over the entire bandwidth as a function of frequency. For

$$y_i = \log_{10}(x_i) \quad i = 1, 2, \dots, N$$

Mean estimate for true mean, μ_y is given by

$$\mu_y = \frac{1}{N} \sum_{i=1}^N y_i$$

MIL-STD-810H
METHOD 514.8, ANNEX F, APPENDIX B

and the unbiased estimate of the standard deviation for the true standard deviation σ_y is given by

$$\sigma_y = \sqrt{\frac{\sum_{i=1}^N (y_i - \mu_y)^2}{N-1}}$$

2.3.1 NTL - Upper Normal One-Sided Tolerance Limit.

The upper normal one-sided tolerance limit on the proportion β of population values that will be exceeded with a confidence coefficient, γ , is given by $NTL(N, \beta, \gamma)$, where

$$NTL(N, \beta, \gamma) = 10^{\mu_y + \sigma_y k_{N, \beta, \gamma}}$$

where $k_{N, \beta, \gamma}$ is the one-sided normal tolerance factor given in Table 514.8F-B.I for selected values of N , β , and γ . NTL is termed the upper one-sided normal tolerance interval (of the original set of estimates) for which 100β percent of the values will lie below the limit with 100γ percent confidence. For $\beta = 0.95$ and $\gamma = 0.50$, this is referred to as the 95/50 limit.

The following table from reference g, contains the k value for selected N , β , and γ . In general this method of estimation should not be used for small N with values of β and γ close to 1 since it is likely the assumption of the normality of the logarithm transform of the estimates will be violated.

MIL-STD-810H
METHOD 514.8, ANNEX F, APPENDIX B

Table 514.8F-B.I. Normal Tolerance Factors for Upper Tolerance Limit.

N	$\gamma = 0.50$			$\gamma = 0.90$			$\gamma = 0.95$		
	$\beta = 0.90$	$\beta = 0.95$	$\beta = 0.99$	$\beta = 0.90$	$\beta = 0.95$	$\beta = 0.99$	$\beta = 0.90$	$\beta = 0.95$	$\beta = 0.99$
3	1.50	1.94	2.76	4.26	5.31	7.34	6.16	7.66	10.55
4	1.42	1.83	2.60	3.19	3.96	5.44	4.16	5.14	7.04
5	1.38	1.78	2.53	2.74	3.40	4.67	3.41	4.20	5.74
6	1.36	1.75	2.48	2.49	3.09	4.24	3.01	3.71	5.06
7	1.35	1.73	2.46	2.33	2.89	3.97	2.76	3.40	4.64
8	1.34	1.72	2.44	2.22	2.76	3.78	2.58	3.19	4.35
9	1.33	1.71	2.42	2.13	2.65	3.64	2.45	3.03	4.14
10	1.32	1.70	2.41	2.06	2.57	3.53	2.36	2.91	3.98
12	1.32	1.69	2.40	1.97	2.45	3.37	2.21	2.74	3.75
14	1.31	1.68	2.39	1.90	2.36	3.26	2.11	2.61	3.58
16	1.31	1.68	2.38	1.84	2.30	3.17	2.03	2.52	3.46
18	1.30	1.67	2.37	1.80	2.25	3.11	1.97	2.45	3.37
20	1.30	1.67	2.37	1.76	2.21	3.05	1.93	2.40	3.30
25	1.30	1.67	2.36	1.70	2.13	2.95	1.84	2.29	3.16
30	1.29	1.66	2.35	1.66	2.08	2.88	1.78	2.22	3.06
35	1.29	1.66	2.35	1.62	2.04	2.83	1.73	2.17	2.99
40	1.29	1.66	2.35	1.60	2.01	2.79	1.70	2.13	2.94
50	1.29	1.65	2.34	1.56	1.96	2.74	1.65	2.06	2.86
∞	1.28	1.64	2.33	1.28	1.64	2.33	1.28	1.64	2.33

2.3.2 NPL - Upper Normal Prediction Limit.

The upper normal prediction limit is the value of \mathcal{X} (for the original data set) that will exceed the next predicted or measured value with confidence coefficient, γ , and is given by

$$NPL(N, \gamma) = 10^{\mu_y + \sigma_y \sqrt{1 + \frac{1}{N}}} t_{N-1; \alpha}$$

where $\alpha = 1 - \gamma$ and $t_{N-1; \alpha}$ is the student t distribution variable with $N - 1$ degrees of freedom at the $100\alpha = 100(1 - \gamma)$ percentage point of the distribution. This estimate, because of the assumptions behind its derivation, requires careful interpretation relative to measurements made in a given location or over a given zone (reference g).

2.4 Nonparametric Upper Limit Statistical Estimate Assumptions.

If there is some reason to believe that the data, after it has been logarithm-transformed, will not be sufficiently normally distributed to apply the parametric limits defined above, consideration must be given to nonparametric limits, i.e., limits that are not dependent upon assumptions concerning the distribution of estimate values. In this case there is no need to transform the data estimates. All of the assumptions concerning the selection of estimates are applicable for nonparametric estimates. With additional manipulation, lower bound limits may be computed.

2.4.1 ENV - Upper Limit.

The maximum upper limit is determined by selecting the maximum estimate value in the data set.

$$ENV(N) = \max\{x_1, x_2, \dots, x_N\}$$

MIL-STD-810H
METHOD 514.8, ANNEX F, APPENDIX B

The main disadvantage of this estimate is that the distributional properties of the estimate set are neglected so that no probability of exceedance of this value is specified. In the case of outliers in the estimate set, $ENV(N)$ may be far too conservative. $ENV(N)$ is also sensitive to the bandwidth of the estimates.

2.5 DFL – Upper Distribution-Free Tolerance Limit.

The distribution-free tolerance limit that uses the original untransformed sample values is defined to be the upper limit for which at least the fraction β of all sample values will be less than the maximum predicted or measured value with a confidence coefficient of “ γ ”. This limit is based on order statistic considerations.

$$DFL(N, \beta, \gamma) = x_{\max}; \gamma = 1 - \beta^N$$

where x_{\max} is the maximum value of the set of estimates, β , is the fractional proportion below x_{\max} , and γ is the confidence coefficient. N , β , and γ are not independently selectable. That is

- (1) Given N and assuming a value of β , $0 \leq \beta \leq 1$, the confidence coefficient can be determined.
- (2) Given N and γ , the proportion β can be determined.
- (3) Given β and γ , the number of samples can be determined such that the proportion and confidence can be satisfied (for statistical experiment design).

$DFL(N, \beta, \gamma)$ may not be meaningful for small samples of data, $N \leq 13$, and comparatively large β , $\beta > .95$. $DFL(N, \beta, \gamma)$ is sensitive to the estimate bandwidth.

2.6 ETL – Upper Empirical Tolerance Limit.

The empirical tolerance limit uses the original sample values and assumes the predicted or measured estimate set is composed of N measurement points over M frequency resolution bandwidths for a total of NM estimate values. That is

$$\{x_{11}, x_{12}, \dots, x_{1M}; x_{21}, x_{22}, \dots, x_{2M}; x_{N1}, x_{N2}, \dots, x_{NM}\}$$

where m_j is the average estimate at the j^{th} frequency bandwidth over all N measurement points

$$m_j = \frac{1}{N} \sum_{i=1}^N x_{ij} \quad j = 1, 2, \dots, M$$

m_j is used to construct an estimate set normalized over individual frequency resolution bandwidths. That is

$$\{u\} = \{u_{11}, u_{12}, \dots, u_{1M}; u_{21}, u_{22}, \dots, u_{2M}; u_{N1}, u_{N2}, \dots, u_{NM}\}$$

$$\text{where: } u_{ij} = \frac{x_{ij}}{m_j} \quad i = 1, 2, \dots, N; \quad j = 1, 2, \dots, M$$

The normalized estimate set, $\{u\}$, is ordered from smallest to largest and

$$u_\beta = u_{(k)} \text{ where } u_{(k)} \text{ is the } k^{th} \text{ ordered element of set } \{u\} \text{ for } 0 < \beta = \frac{k}{MN} \leq 1$$

MIL-STD-810H
METHOD 514.8, ANNEX F, APPENDIX B

is defined. For each resolution frequency bandwidth, then

$$ETL(\beta) = u_{\beta} m_j = x_{\beta j} \quad j = 1, 2, \dots, M$$

Using m_j implies that the value of $ETL(\beta)$ at j exceeds β percent of the values with 50 percent confidence.

If a value other than m_j is selected, the confidence level may increase. It is important that the set of estimates is homogeneous to use this limit, i.e., they have about the same spread in all frequency bands. In general, apply this limit only if the number of measurement points, N , is greater than 10.

2.7 Example from Measured Data.

An example consisting of typical wheeled vehicle data (4 test courses, 3 data runs, 2 locations) is considered. The ensemble consists of a total of 24 average ASD measurements. The normal tolerance limit (NTL) of the 24 item ensemble (without being logarithm transformed) was computed as, $NTL(N, \beta, \gamma) = \mu + k\sigma$ as described in paragraph 2.4, and is illustrated in Figure 514.8F-B.2. For this example, $\beta = .95$ and $\gamma = .75$ were selected, yielding a value of $k = 1.91$ interpolated from Table 514.8F-B.I.

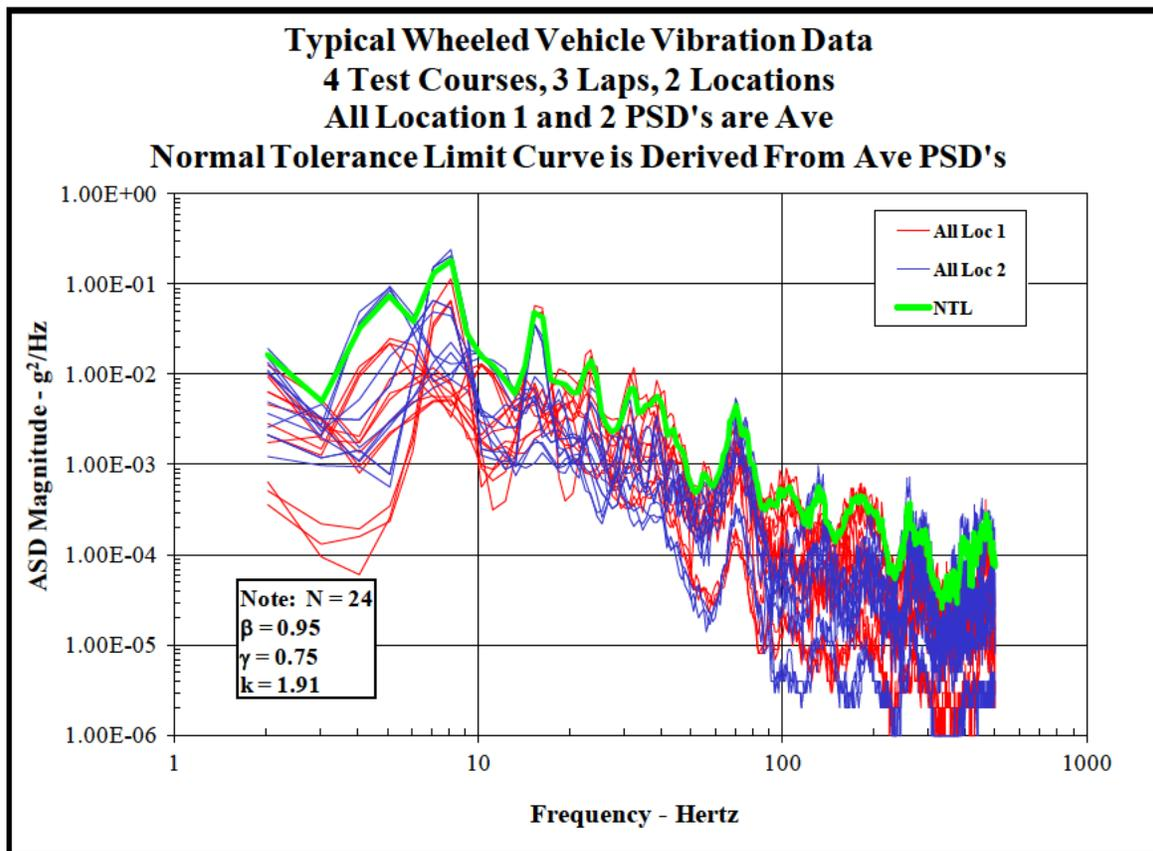


Figure 514.8F-B.2. Example normal tolerance limit applied to typical wheeled vehicle data.

MIL-STD-810H
METHOD 514.8, ANNEX F, APPENDIX B

3. COMMON ANALYSIS FUNCTIONS AND STATISTICAL DEFINITIONS OF VSD DATA ENSEMBLES.

In preparation for a VSD effort, vibration time histories are recorded for a series of test conditions (defined as "events" in Annex F, paragraph 3) also referred to as "runs". An event is defined (for ground vehicles) as operation over a specific uniform terrain, for a specific test item configuration (load, tire pressure, etc.) at a constant speed. For an aircraft, one may have a list of events defined in terms of various modes of flight (level flight, rolling maneuvers, etc.) conducted at various airspeeds. A common form of analysis involves converting the complete time history (of a particular channel) into the compressed frequency domain format of the ASD function by dividing the time history into equal length data blocks and computing the ASD for each of the data blocks independently. When combining spectra, it is assumed that the spectra being combined represent a homogeneous set. (i.e., overall spectral levels are comparable and the spectra have the same general shape). If this is not the case, combining spectra should be avoided and another "spectra category" should be added to represent the test condition. When computing estimates of these ASD functions, it is desirable to compute the linear average (assuming the number of samples is sufficiently large ($n_d > 30$), the standard deviation and the peak, all as a function of frequency, over the length of a test run. The standard deviation represents the variation in the spectral data, as a function of frequency, at a given location on the vehicle due to randomness of the test process. Although the data are stationary, excursions about the mean occur in both the time and frequency domains.

In addition to computing the mean ASD of an individual event, the standard deviation, and peak versions of the ASD are often of interest. For ease of illustration, the following symbolic structure will be employed:

$$G_m(f) = \text{ASD}(\text{mean}) = \hat{G}_{xx}(f) \quad \text{B.3}$$

$$G_i(f) = \text{ASD}(\text{instantaneous}) \text{ ASD computed over a single time interval } T$$

$$G_d(f) = \text{ASD}(\text{Standard Deviation}) = G_d(f) = \left[\frac{1}{n_d - 1} \sum_{i=1}^{n_d} (G_i(f) - G_m(f))^2 \right]^{\frac{1}{2}}$$

$$G_s(f) = \text{ASD}(\text{Sum}) = G_m(f) + G_d(f) \quad \text{B.4}$$

$$G_p(f) = \text{ASD}(\text{Peak}) = \text{MAX}_{i=1}^{i=n_d} [G_i(f)] \quad \text{B.5}$$

Note that, statistically speaking, the normalized error for the (Peak) spectrum could be very high because of the limited number of degrees of freedom available from the peak values of $G_i(f)$. This spectrum is a maxi-max auto spectral density estimate and should be used with caution (if at all). An example generation of the spectra discussed above as computed from data acquired from a typical wheeled vehicle data is shown in Figure 514.8F-B.3.

MIL-STD-810H
METHOD 514.8, ANNEX F, APPENDIX B

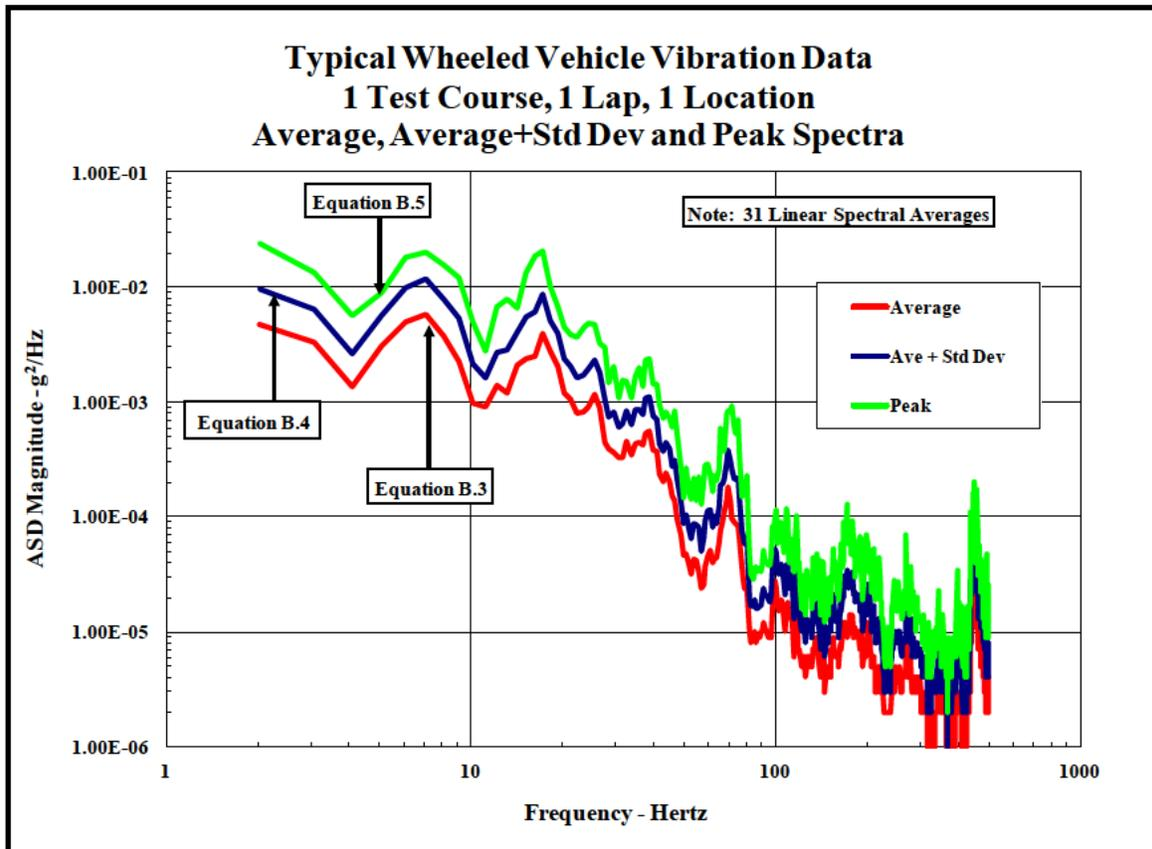


Figure 514.8F-B.3. Average, average plus standard deviation, and peak spectra.

During the VSD process, classical statistics are often employed in somewhat of an ad hoc manner to address unknowns and sample size limitations. The data from many locations and many test events can be combined (by axis) using different techniques to produce representative composite spectra. The first technique is a simple linear average of all average spectra from all channels and all events to produce an overall average spectrum. If the mean and the median of the distribution are the same (which is the case for Gaussian data), this represents approximately the 50th percentile of the spectral data. A second technique is a "standard" conservative approach often integrated into the VSD process in which the ASD(Sum) spectra from each channel and each event are combined by using the average of these spectra with the addition of one standard deviation. The standard deviation computed during this process represents considerations such as the spectral variance due to location, test course differences, and courses not considered and is not the same as $G_d(f)$. Mathematically this spectral average is shown as:

$$G_a(f) = \frac{1}{M} \sum_{i=1}^M G_{s_i}(f)$$

Where, M represents the number of events considered in the computation of the average spectra.

The standard deviation of ASD values due to variations in test courses and instrumentation locations as a function of frequency is defined as:

$$G_e(f) = \left[\frac{1}{M-1} \sum_{i=1}^M [G_{s_i}(f) - G_a(f)]^2 \right]^{\frac{1}{2}}$$

MIL-STD-810H
METHOD 514.8, ANNEX F, APPENDIX B

The final spectral measurement defined is:

$$G_f(f) = G_a(f) + G_e(f) \quad \text{B.6}$$

Computation of $G_f(f)$ is a key component used in the VSD techniques defined in Annex F, Appendix D.

Consider the same ensemble of data as discussed in paragraph 2.7 (typical wheeled vehicle data (4 test courses, 3 data runs, 2 locations)). Figure 514.8F-B.4 includes an overlay of all 24 spectra with the average of the ensemble of $G_s(f)$ spectra shown in yellow and the final representative spectrum, $G_f(f)$, shown in green.

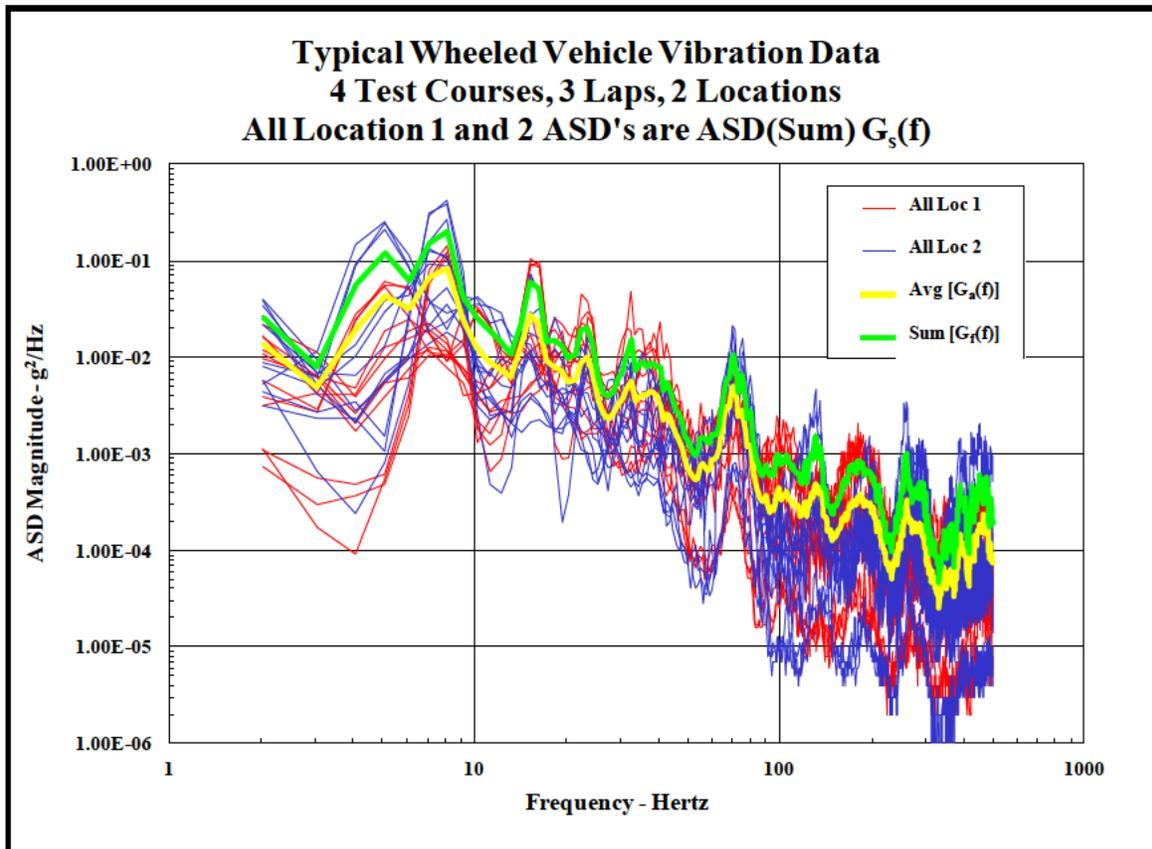


Figure 514.8F-B.4. Combination of 24 individual spectra.

It is desirable for a vibration schedule to be a conservative estimate of the true environment within some credible bounds. A conservative estimate is required for two reasons. First, the test sample size is limited (usually one vehicle) and some allowance must be made for differences within a class of vehicle. Second, vibration control systems take the test specification in ASD form and create a time history (to drive the shaker) by assuming a Gaussian distribution of amplitudes in the time domain. Wheeled vehicle vibration data is nearly Gaussian, but generally has larger "tails" (i.e., more data at high levels and higher peak levels) than a Gaussian distribution of the same mean and standard deviation. Since damage occurs at the tails of the distribution (and not around the mean), it is necessary to amplify the overall level so that the Gaussian process will produce the higher levels commensurate with the measured data. Merely enveloping the peak spectra provides conservatism but results in an over-test since the test rms level is generally much greater than the highest individual level measured. To ensure that the final spectral estimate is at least as large as the actual measured data, this spectrum can be adjusted (amplified or attenuated) so that its rms value is in reasonable agreement with the largest rms value measured at any location during any data run provided the corresponding spectra are similar in shape.

MIL-STD-810H
METHOD 514.8, ANNEX F, APPENDIX B

The resultant spectrum shown in Figure 514.8F-B.5 is compared to an envelope of all the average spectra from the data set (in this case, 24 spectra). Note that the resultant test spectrum is approximately an envelope of the individual spectra.

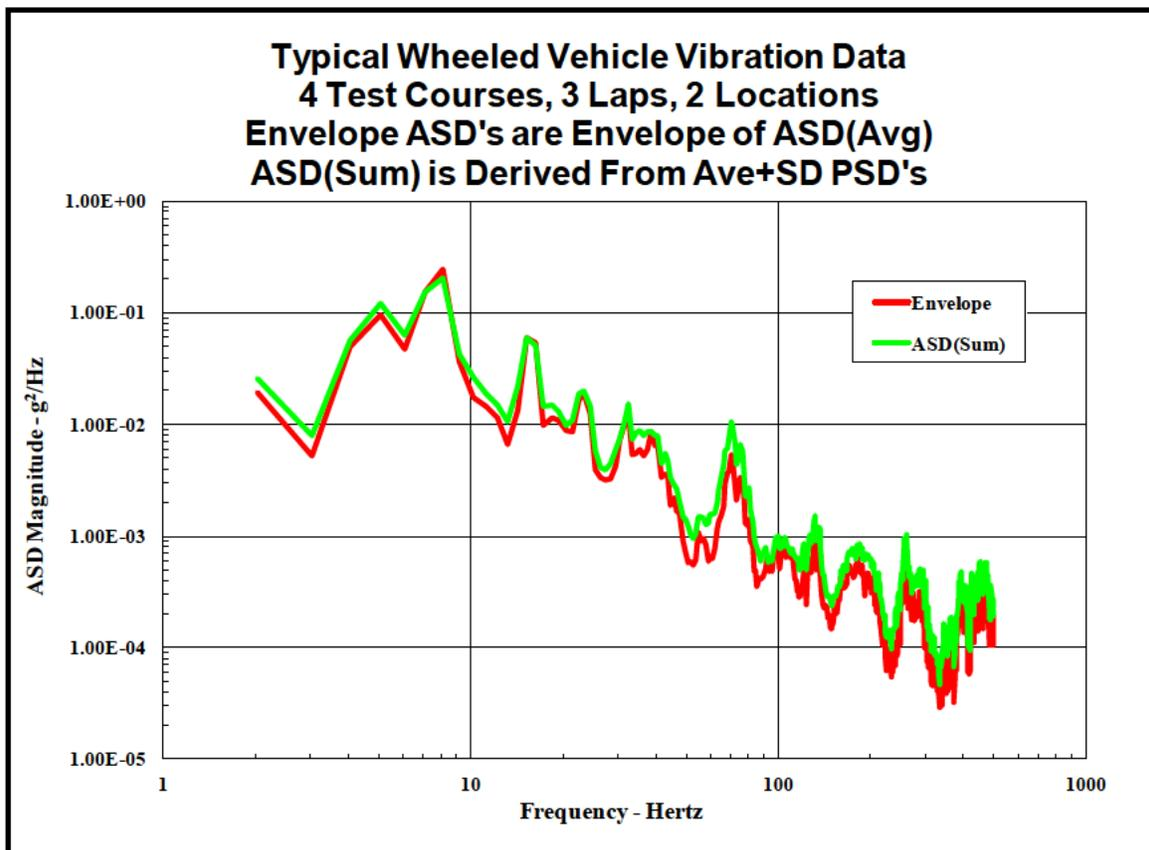


Figure 514.8F-B.5. Comparison of resultant test spectrum (green line) to envelope of individual spectra (red line).

It is important to note that the spectrum described above may be composed of different operating conditions which are not present for the duration assigned to the total environment. For example, if certain frequency components were contributed by operation over a particular test course, they would be applied to the test as if those components occurred for the entire duration, not just the segment represented by operation over that particular test course. In this case, test duration would also apply conservatism to the process, which may or may not be desirable. Problems of this nature are addressed further in the Annex F, Appendix D.

MIL-STD-810H
METHOD 514.8, ANNEX F, APPENDIX C

METHOD 514.8, ANNEX F, APPENDIX C
Combination of Spectra (Fatigue Damage Spectra)

1. FATIGUE DAMAGE SPECTRUM METHOD OF COMBINING SPECTRA.

In 1995, Henderson and Piersol introduced the concept of the fatigue damage spectrum to compare the potential damage to a test item exposed to different tests that had approximately a normal amplitude distribution (reference f). The fatigue damage spectrum is a spectral representation of a fatigue damage index as a function of any system's natural frequency. This spectrum is computed directly from the auto spectral density (ASD) function representing a test situation or a field environment, and provides a relative fatigue damage estimate based on acceleration level and exposure time. As opposed to the pure statistical techniques discussed in Appendix B, consideration of the exposure time as well as spectral and fatigue characteristics makes the FDS an attractive technique in development of a LVTS.

The fatigue damage spectrum is computed from:

$$DP(f_n) = f_n T \left(\frac{G(f_n)}{f_n \zeta} \right)^{\frac{b}{2}} \quad \text{C.1}$$

where:

$DP(f_n)$ = Damage index as a function of system natural frequency

f_n = System natural frequency (variable), Hz

T = Exposure time in environment, seconds

$G(f_n)$ = ASD for a given environment, g^2/Hz

ζ = Damping ratio of system at dominant natural frequency expressed as a decimal

b = Fatigue curve slope value when computed as a linear fit in a log-log domain.

As discussed in Annex F, paragraph 9.2.1.2, the parameter m employed in Equation (9.1) is not equal to b . The value of m is strongly influenced by the material S-N curve, but fatigue life is also influenced by the surface finish, the treatment, the effect of mean stress correction, the contributions of elastic and plastic strain, the waveshape of the strain time history, etc. Historically, a value of $m = 7.5$ has been used for random environments, but values between 5 and 8 are commonly used (note the exponent is $\left(\frac{m}{2}\right)$ in Equation 9.5 when addressing ASD values). One may consider a similar substitution of m for b when using Equation C.1.

Since fatigue damage is based on a cumulative effect of various environments or conditions, a cumulative fatigue damage index can be calculated as the sum of the fatigue damage spectra for individual environments. Thus,

$$DP_t(f_n) = \sum_{i=1}^N DP_i(f_n) \quad \text{C.2}$$

where:

$DP_t(f_n)$ = Total damage index spectrum.

$DP_i(f_n)$ = Individual environment damage spectra as defined in equation C.1.

MIL-STD-810H
METHOD 514.8, ANNEX F, APPENDIX C

2. EXAMPLE APPLICATION OF FATIGUE DAMAGE SPECTRUM.

Historically, four specific test courses at Aberdeen Test Center (ATC) have been used to generate data for vibration specifications for wheeled vehicles. It is improbable to relate the actual amount of each of these road surfaces to any real world scenario (e.g., determine how much Belgian Block a vehicle will encounter for a particular scenario), however it is possible to compute exposure times for operations at ATC and use this information to compute a fatigue damage spectrum by test course. Substantial precedence for using these course and speeds in full vehicle tests exists (first introduced as Large Assembly Transport Test of MIL-STD-810B, June 1967), so it is logical to use them as a basis for simulation. Each course has a measured length and is traversed at a nominal speed, leading to an exposure time. This information is presented in Table 514.8F-C.I.

Table 514.8F-C.I. Test Course Lengths, Speeds and Exposure Times

Test Course	Length, m (ft)	Nominal Speed, km/hr (mph)	Exposure Time, sec
Belgian Block	1200 (3940)	32.2 (20)	134
Two-Inch Washboard	250 (822)	16.2 (10)	56
Radial Washboard	74 (243)	24.1 (15)	11
Three Inch Spaced Bump	233 (764)	32.2 (20)	26
Total	1757 (5769)		227

The exposure times can be used with equation C.1 and the appropriate test course ASDs to produce a fatigue damage spectrum for each test course. Using the same set of typical wheeled vehicle data as before, the fatigue spectra are shown in Figure 514.8F-C.1. For this example, ζ was chosen to be 0.05 (5-percent critical damping) and the exponent m was substituted for b , and was assigned a value of 7.5.

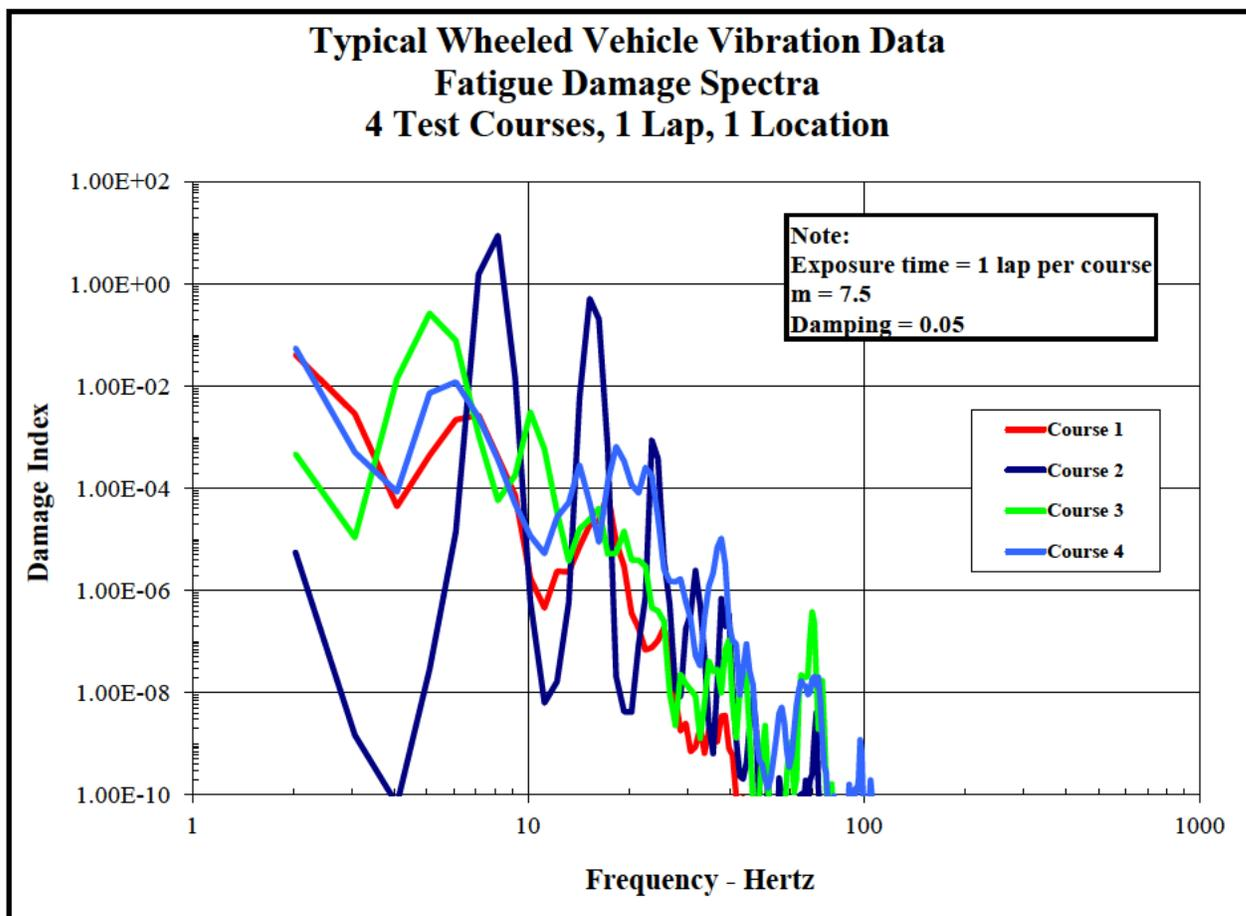
MIL-STD-810H
METHOD 514.8, ANNEX F, APPENDIX C

Figure 514.8F-C.1. Fatigue damage spectra for specific test courses.

The cumulative fatigue damage spectrum (equation C.2) is shown by the lavender line in Figure 514.8F-C.2 and represents a fatigue damage index derived from a complete lap of the four specified test courses.

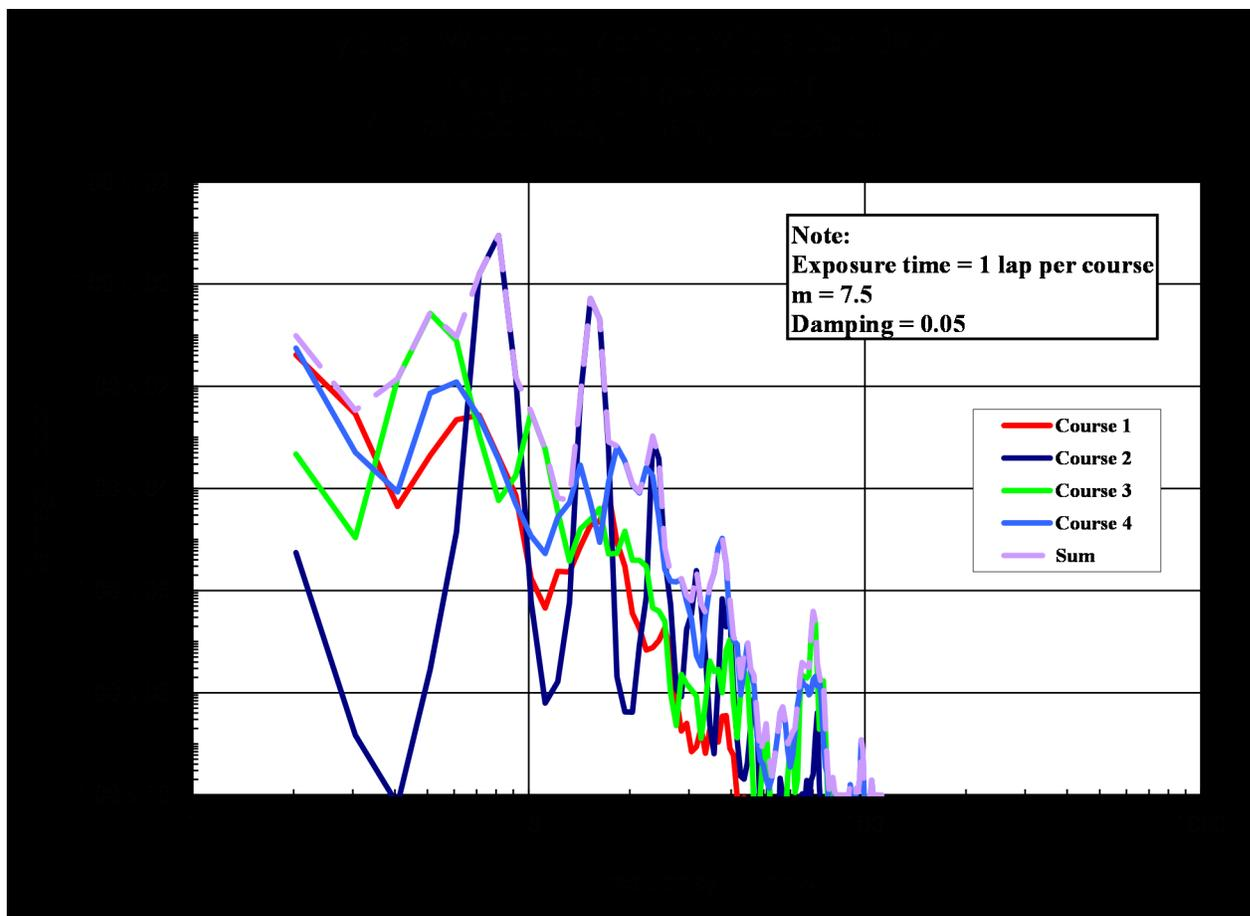
MIL-STD-810H
METHOD 514.8, ANNEX F, APPENDIX C

Figure 514.8F-C.2. Cumulative fatigue damage spectrum (lavender line).

The same process was performed for 2 measurement locations independently using cumulative data for 3 laps. The cumulative spectra for each location were then averaged and enveloped for comparison and are shown in Figure 514.8F-C.3.

MIL-STD-810H
METHOD 514.8, ANNEX F, APPENDIX C

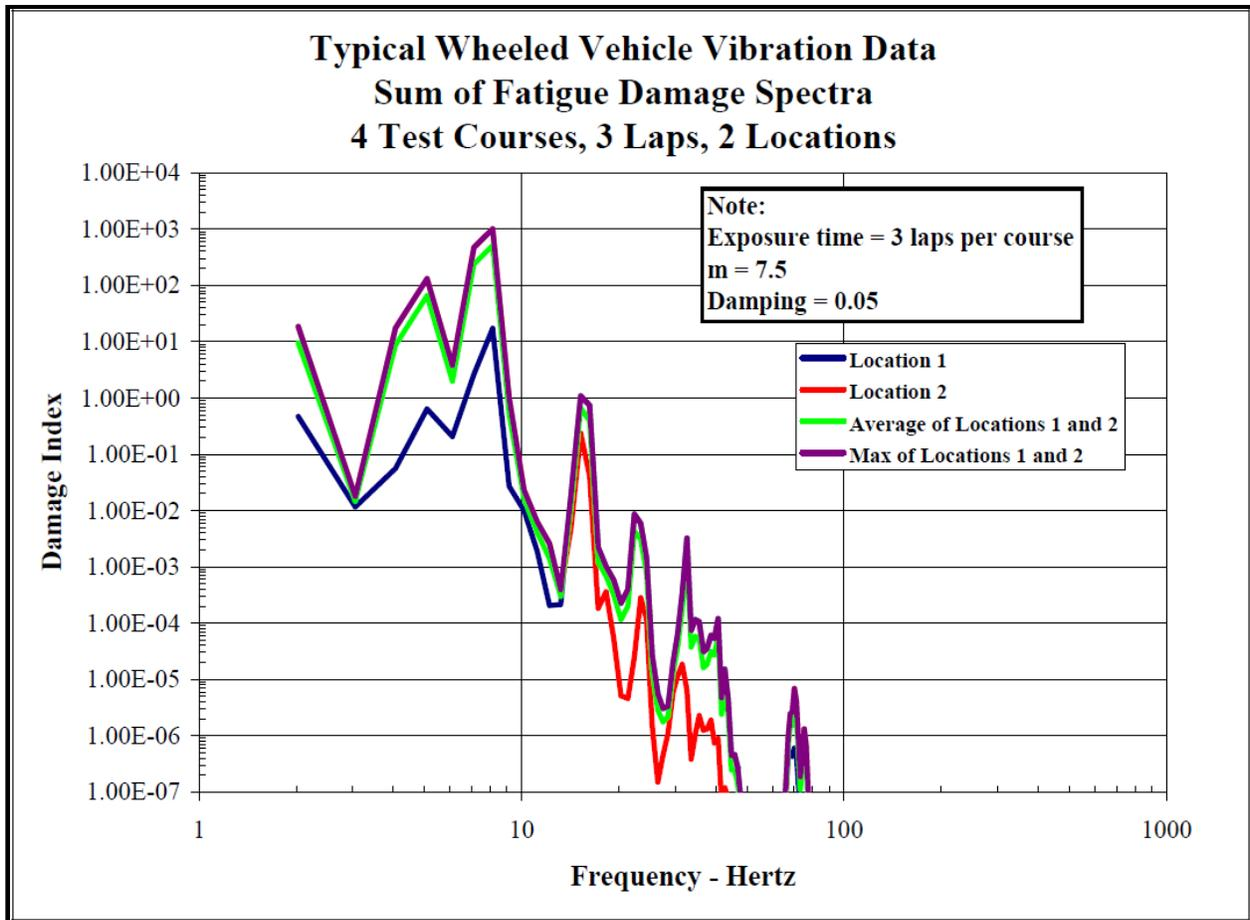


Figure 514.8F-C.3. Cumulative fatigue spectra from locations 1 and 2.

If an overall exposure time is selected, equation C.1 can be reworked to provide an ASD level based on the fatigue spectrum computed from Equation C.2.

$$G(f_n) = f_n \zeta \left(\frac{DP(f_n)}{f_n T} \right)^{\frac{2}{b}} \quad \text{C.3}$$

where:

$DP(f_n)$ = Cumulative damage index as a function of system natural frequency

f_n = System natural frequency (variable), Hz

T = Total exposure time in environment, seconds

$G(f_n)$ = Equivalent ASD for a given $DP(f_n)$, T , g^2/Hz

ζ = Damping ratio of system at dominant natural frequency expressed as a decimal

b = Fatigue curve slope value when computed as a linear fit in log-log domain.

MIL-STD-810H
METHOD 514.8, ANNEX F, APPENDIX C

Using an exposure time equal to 3 times the total value listed in Table 514.8F-C.I (to account for 3 laps) and the fatigue damage spectra (average and max) shown in Figure 514.8F-C.3, an equivalent representative ASD was calculated from equation C.3. The spectra derived from the average and maximum fatigue damage spectra are shown in Figure 514.8F-C.4. For this data set, the fatigue damage spectra for locations 1 and 2 were nearly the same producing an average spectrum that is about the same as the enveloped spectrum. The enveloped or maximum spectrum is compared to the resultant spectrum computed from the statistical process and from a spectrum derived from the envelope of all original spectra and is shown in Figure 514.8F-C.5.

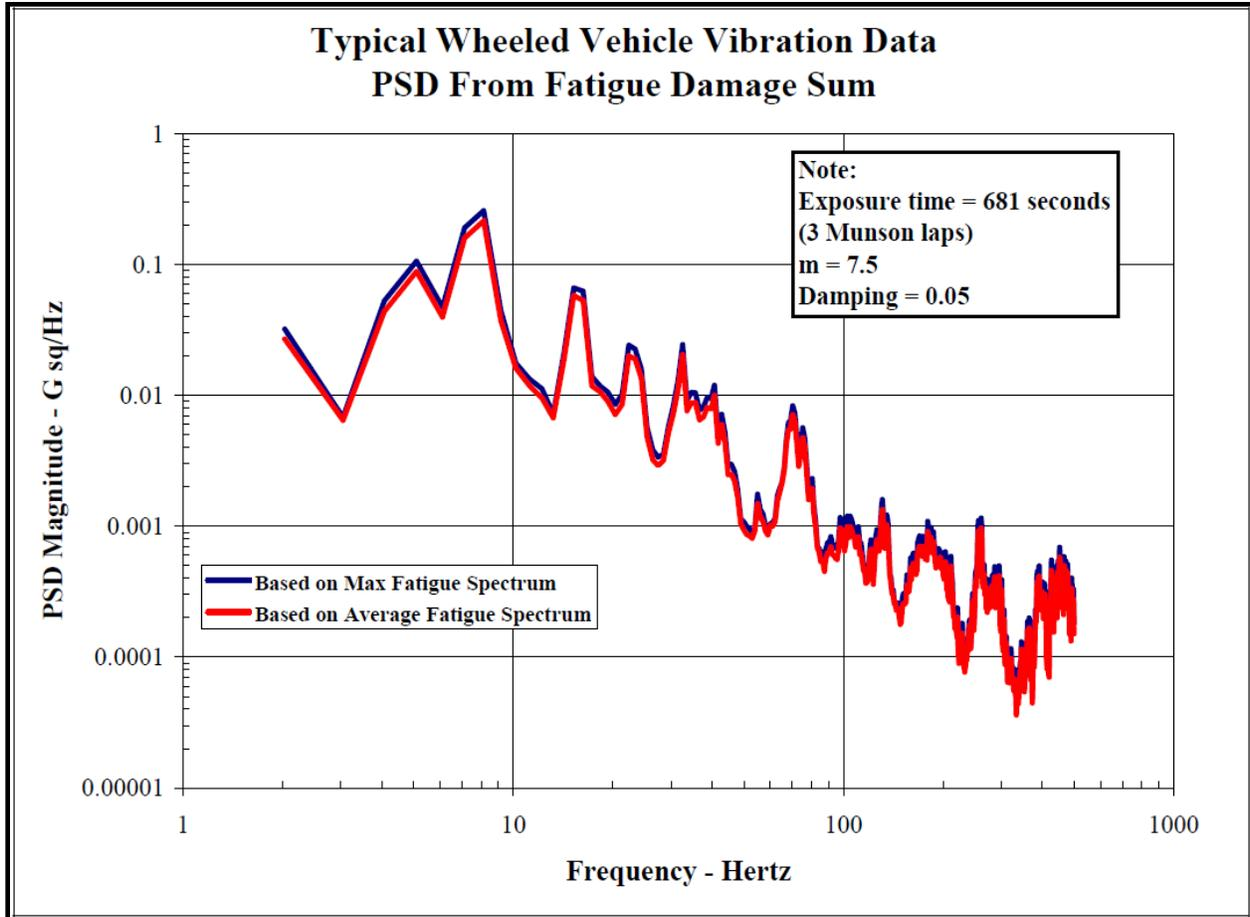


Figure 514.8F-C.4. Combined vibration power spectra developed from average and maximum fatigue damage Spectra.

MIL-STD-810H
METHOD 514.8, ANNEX F, APPENDIX C

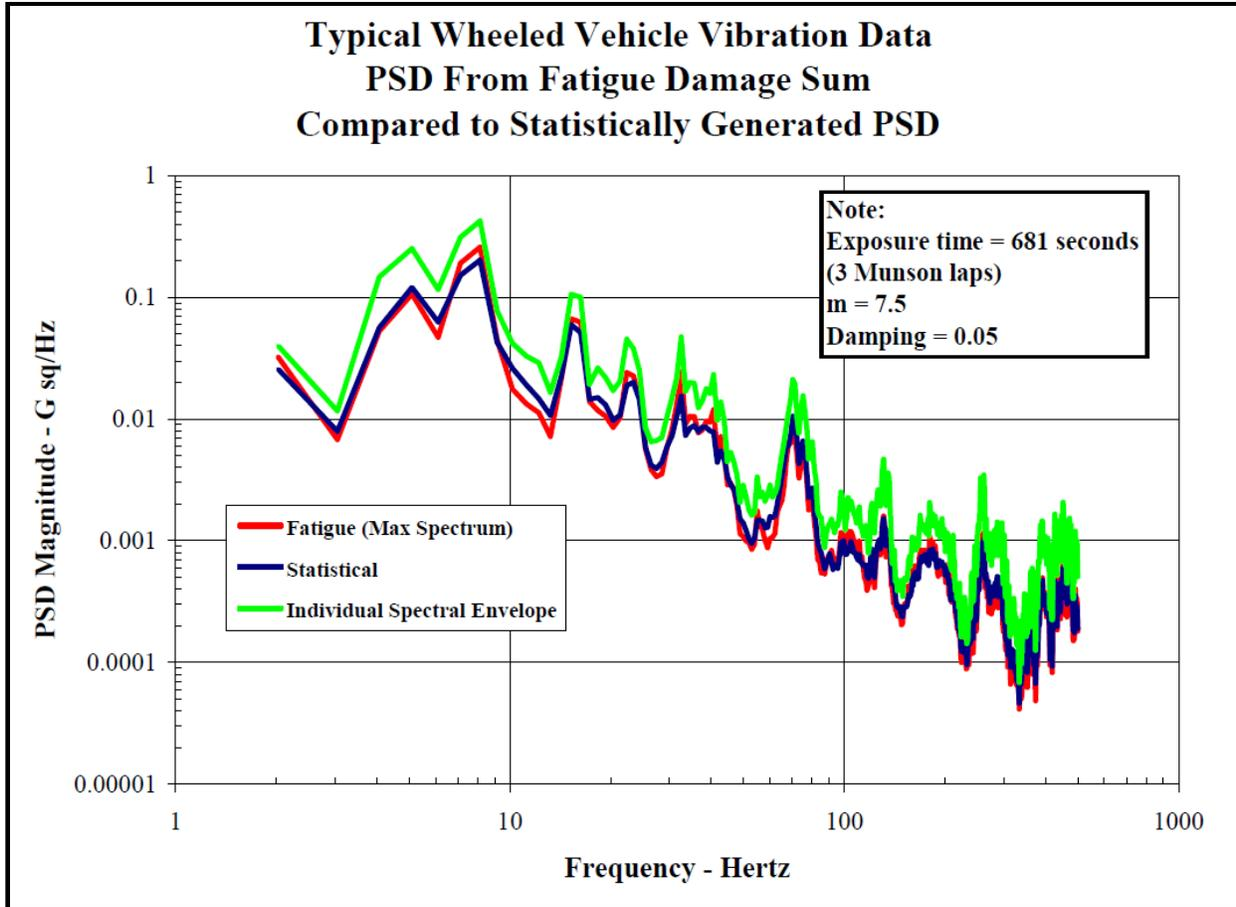


Figure 514.8F-C.5. Comparison of combined vibration power spectrum developed from the fatigue damage spectrum, from the statistical process and from an envelope process.

The three processes (fatigue spectrum, statistical and envelope) produce specifications that are roughly the same shape. The specification derived from the fatigue damage spectrum technique has lower levels than those produced by the envelope process and nearly the same (but generally lower) levels than those produced by the technique developed in Appendix B. The statistical technique contains an implied assumption that each environment has the same exposure time and weights the spectral values toward the most severe spectrum due to the inclusion of spectral variance (the addition of a standard deviation) in the process. Therefore, it is likely that the statistical process will produce higher levels than the fatigue damage process unless the most severe spectra also have the longest exposure times.

The process was repeated for an exponent value of $m = 5$ as a comparison. A comparison of the fatigue damage spectra (maximum) for the two exponents is shown in Figure 514.8F-C.6, and a comparison of the vibration power spectra developed from each exponent is presented in Figure 514.8F-C.7.

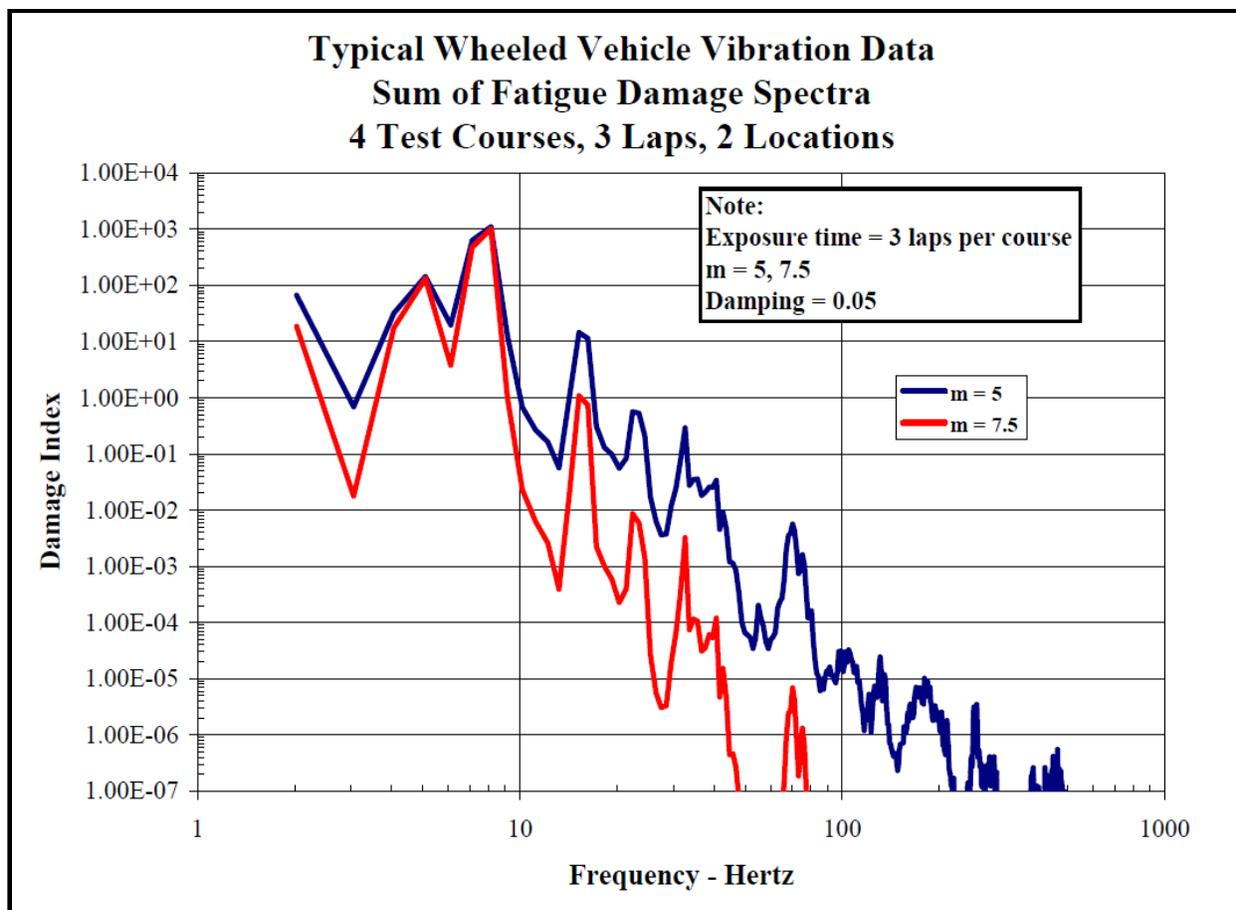
MIL-STD-810H
METHOD 514.8, ANNEX F, APPENDIX C

Figure 514.8F-C.6. Fatigue damage spectra for two exponents.

MIL-STD-810H
METHOD 514.8, ANNEX F, APPENDIX C

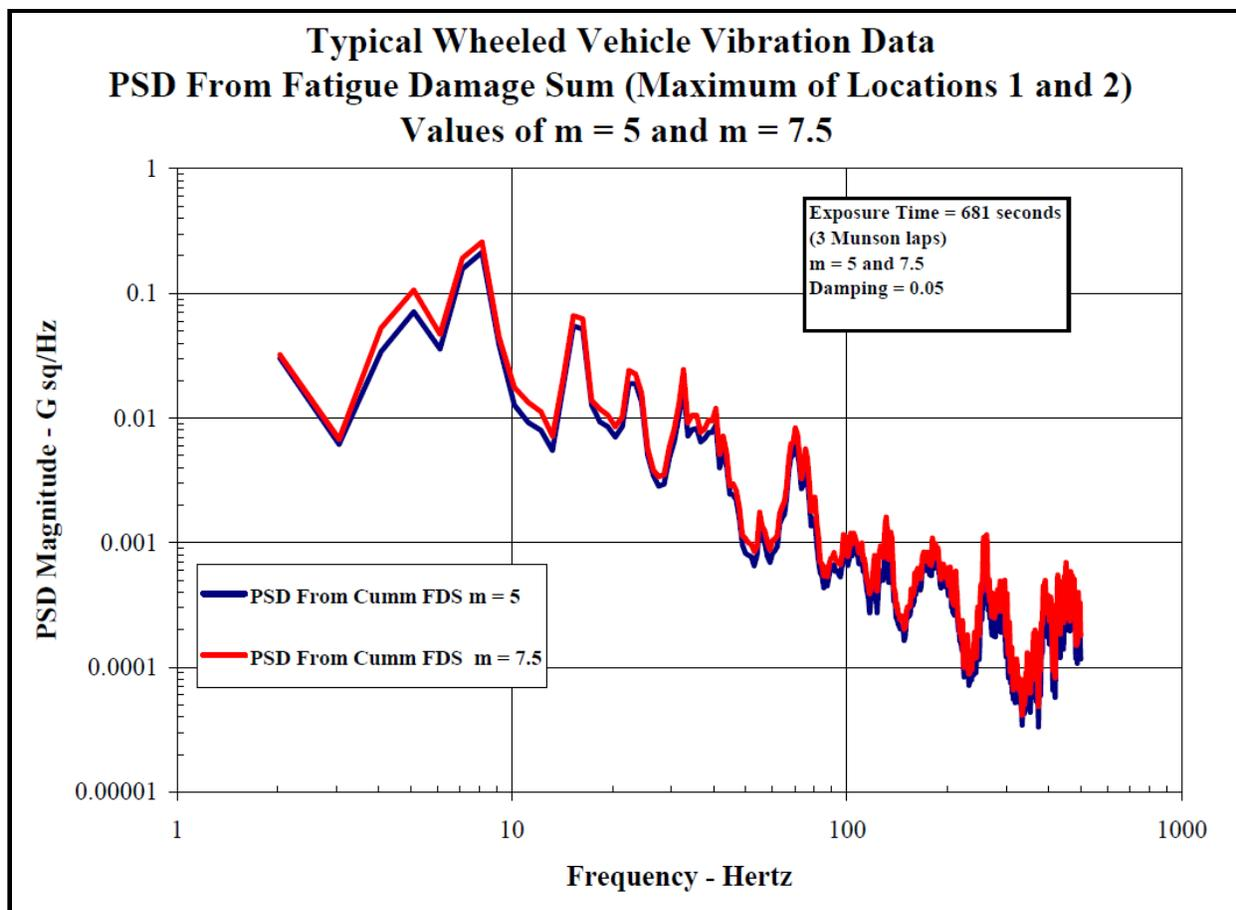


Figure 514.8F-C.7. Comparison of combined vibration power spectra developed from two exponents.

For this set of measured environments (acceleration spectra) and associated exposure times, the final combined spectrum is somewhat independent of the value of the exponent chosen. Forty percent of the spectral amplitudes for the two exponents were within 1 dB (based on $m=7.5$ as the reference), 80 percent were within 2 dB and all were within 2.4 dB.

Documentation of the spectral combination process, including assumptions (e.g., value of b), is essential. The final combined spectrum should be compared to the original input spectra to ensure that the resultant spectrum is a reasonable representation of the measured environment.

3. FDS APPROACH TO DEVELOPMENT OF A LVTS.

In summarizing the example provided in the previous section, a single ASD was computed, representative of the ensemble of data acquired from making three passes over four specific road courses. The ASD derived from the inverse of the cumulative FDS is compared to the envelope of the data ensemble as shown in Figure 514.8F-C.5. From Figure 514.8F-C.7 it is clear that the spectral shapes and amplitudes are very similar for the ASD's derived in the examples in previous section for both selections of m ($m=5$ and $m=7.5$). From Figure 514.8F-C.5 it is also clear that the ASD computed from the inverse cumulative FDS falls significantly below the envelope of the data ensemble. Employing equation 9.5, one could easily compress the test time by increasing the magnitude of the ASD. This can be accomplished by changing the T parameter of equation C.3. As in Annex F, paragraph 9, one should always use caution in employing time compression techniques. When dealing with data of a similar spectral characteristic, a conservative approach would be to limit the final compressed spectral shape to the spectral shape of the envelope of the original data ensemble. Reviewing the spectral shapes of the ASD's computed from the inverse cumulative FDS and the envelope of the original data ensemble, it is clear that the ratio between the two curves is not the same at each spectral line. Therefore, one will need to set some criteria, which is often test specific, for addressing the amount of

MIL-STD-810H
METHOD 514.8, ANNEX F, APPENDIX C

time compression employed. In the example discussed in this Appendix, the average ratio between 2 and 100 Hz was set at the compression ratio. This spectral band was considered to be of primary importance for this example since the data set was from a wheeled vehicle and the spectrum is dominated by energy below 100 Hz. Figure 514.8F-C.8 illustrates the effect of time compression based on the ratio described above. Using the time compressed spectral shape, the test time reduces from 681 seconds (the actual time spent on the courses) to either 72 seconds (when $m=5$) or 54 seconds (when $m=7.5$). As a final step, the analyst will usually reduce the number of breakpoints (smooth the spectral shape) while maintaining the overall G-rms level.

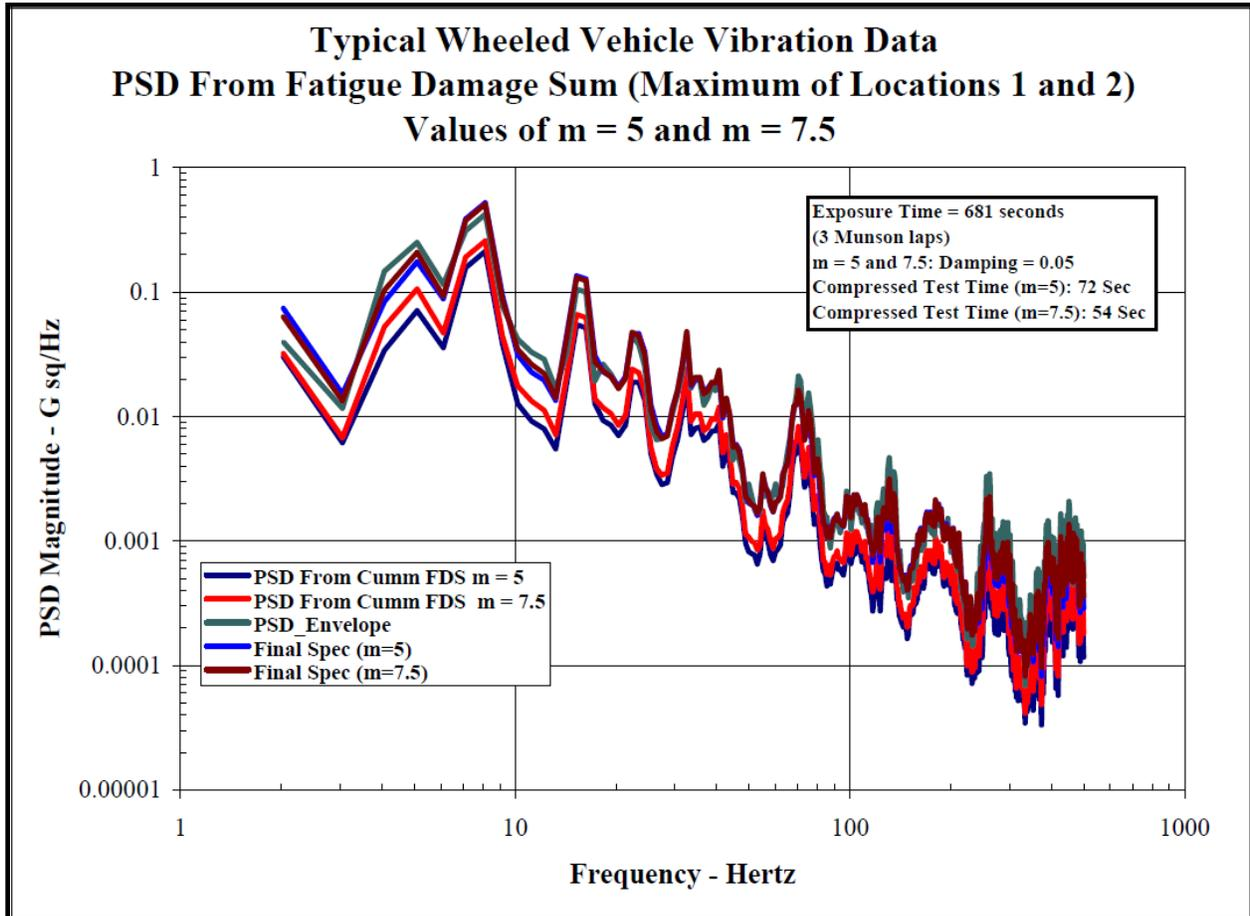


Figure 514.8F-C.8. Time compression of ASD's computed from the inverse cumulative fatigue damage spectrum.

This example is relatively simple; however, the techniques could easily be expanded to address more complex ensembles of data to include spectra with either narrowband or tonal components.

MIL-STD-810H
METHOD 514.8, ANNEX F, APPENDIX D

METHOD 514.8, ANNEX F, APPENDIX D
Vibration Specification Development Procedure

1. INTRODUCTION.

This Appendix outlines a Vibration Schedule Development (VSD) procedure designed to combine an ensemble of vibration events and associated exposure times into a smaller set of vibration profiles and associated run times. The vibration events are in the form of a set of digital data files that collectively represent the full fatigue exposure of the test item. The goal is to produce a small set of Laboratory Vibration Test Schedules (LVTS) that can induce equivalent fatigue exposure with a vibration exciter. The procedure can be used to develop broadband random, Sine-on-Random (SOR) or Narrowband Random on Random (NBROR) LVTS. Figure 514.8F-D.1 illustrates the VSD procedure in an abbreviated block diagram format.

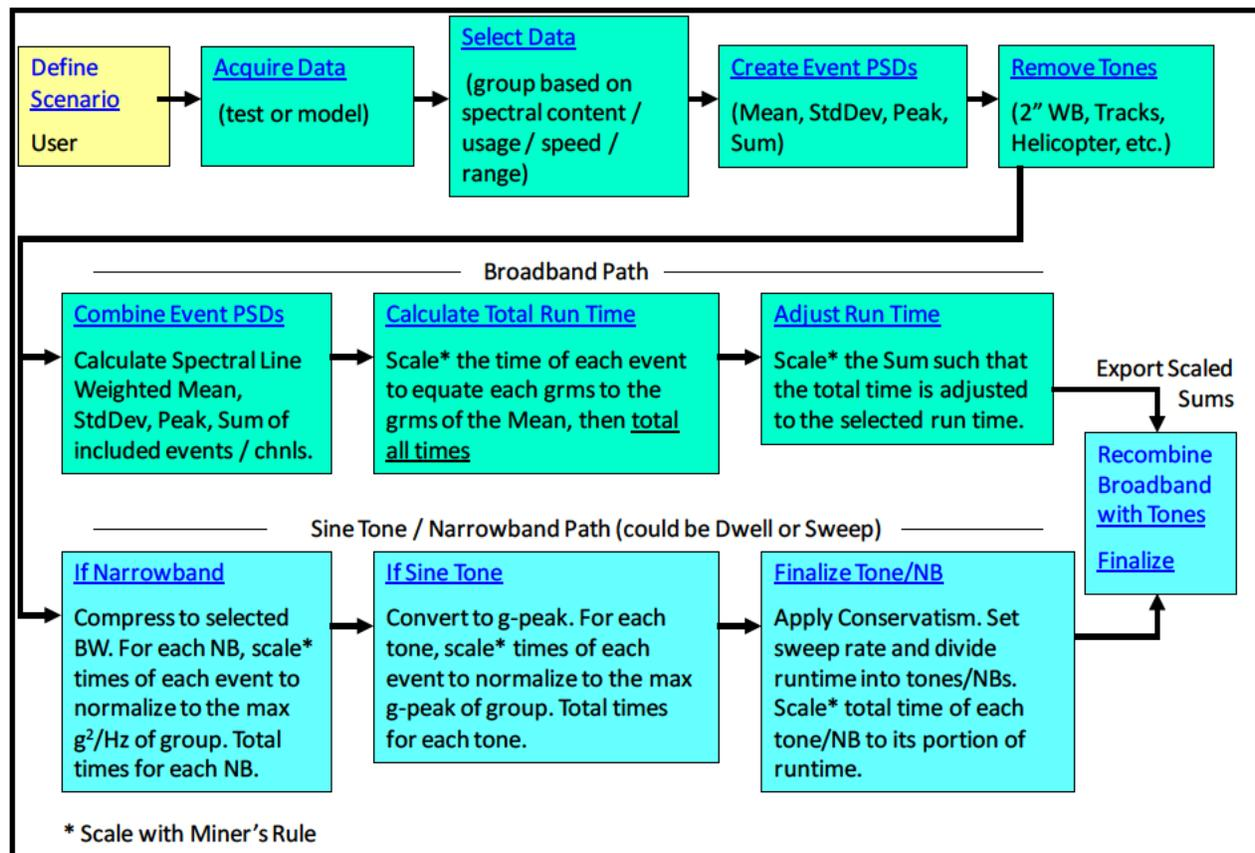


Figure 514.8F-D.1. VSD flowchart.

Data are typically processed in multiple channel sets, as it is often desirable that specific channels are processed with common frequency resolution or be reduced to common test times to allow development of schedules based on multiple locations. The procedure is best implemented in specially designed software. Software tools should be developed to implement the following:

- a. A general-purpose signal analysis package used as a pre-processing tool prior to the actual schedule development. Routine pre-processing analyses includes: Time Histories, RMS vs. Time, Min/Max, Kurtosis, Histograms, Skewness and Stationarity.
- b. Specialized routines to manage the test database and manipulate the test data as necessitated by the VSD procedure. The routines can be grouped into a single software package for ease of implementation. The package should manipulate the event files and output an intermediate LVTS in ASCII or spreadsheet format.

MIL-STD-810H
METHOD 514.8, ANNEX F, APPENDIX D

- c. Spreadsheets developed to produce final LVTS's using files generated by the specialized software. Spreadsheets provide a convenient method for addressing activities such as combining multiple channel profiles into a single LVTS, processing narrowband and/or sine tones, combining narrowband and broadband components, inclusion of fleet severity factors and scaling test times to user selected values.
- d. A subroutine to pick a series of breakpoints to represent the broadband profile generated by the process. The points should be picked such that the shape and rms level of the vibration profile are preserved with the minimal number of breakpoints.

The following definition is provided to aid in method discussion. A review of the definitions found in Annex F, paragraph 3 would also be beneficial.

Sum-Set – A matrix of ASDs used as an organizational tool for process implementation. There are two types of sum-set, the single-event ASD sum-set and the group sum-set. The two sum-sets will be defined as required in this Appendix.

Before the VSD process begins a number of parameters must be defined. Table 514.8F-D.I lists some parameters relevant for the process. Other parameters will be discussed in subsequent sections of this document as necessary.

The process can be implemented as discussed in the following sections.

Table 514.8F-D.I. VSD Required Parameters

Block Size	The number of data samples to include in ASD calculation. The block size is typically set equal to the sample rate to give a 1 second block and 1 Hz ASD resolution.
Window Type	The window type to use for ASD calculation, typically Hann.
Minimum g-rms threshold	Used to assure low level events will not overly affect LVTS ASD shape. The threshold is set as a g-rms ratio (default 50%) of the maximum ASD in the group.
Crest Factor Threshold	These thresholds can be used to alert the analyst if a section of data is grossly non-Gaussian. The analyst can then decide if the data should be excluded from the development process.
Skewness Threshold	
Kurtosis Threshold	
Start Frequency	This is the start frequency for the broadband portion of the LVTS. This is typically set to 5 Hz or the frequency of the lowest tonal component.
End Frequency	This is the upper limit of the LVTS bandwidth. This should be set by a review of the data. Typically used values include 200 Hz, 500 Hz, or 2000 Hz.
N_e, N_g	Analyst defined factors defining the number of standard deviations to use in the process (default = 1). N_e is for an individual event and N_g is for combining multiple events.
M_e, M_g	Analyst defined factors to limit conservatism in the process. M_e is for an individual event and M_g is for combining multiple events.
DC Component	Remove the DC components from the time domain data before calculation of ASDs. The DC component is often a result of signal conditioner offset and can be removed without affecting LVTS development.

2 BROADBAND PROFILE DEVELOPMENT.

2.1 File Setup (Step 1).

Step 1 is to define the test data of interest by selecting from the data files available on disk. The events selected should collectively represent the expected vibration exposure of the test item. It may be necessary to divide the events into groups of similar ASD shape and level, and produce LVTS separately for each group.

2.2 Select Event Start and End Time (Step 2).

During the collection of the raw field data, it is common practice to begin acquisition prior to reaching a desired speed or start of a particular road surface or maneuver. For this reason, the analyst may need to select only a portion of the digitized data set provided for a particular event. It is helpful to define the start and end time of the data set to be carried forward in the VSD process.

MIL-STD-810H
METHOD 514.8, ANNEX F, APPENDIX D**2.3 Time Block Drop (Step 3).**

Given fixed start and end times, data block size, and overlap percentage, the number and order of data blocks is also fixed. There is the possibility of corrupt data, or bad blocks, within the identified data segment (i.e., momentary telemetry dropouts, off speed sections, shock event, etc.). The analyst must be able to identify specific data blocks for exclusion in the subsequent spectral computations. To prevent discontinuities in the data, the blocks should not be deleted from the time data, but simply excluded during ASD calculation. In the event that the amount of measured data is limited, the analyst may be required to salvage available data through careful removal of limited dropouts in the data set that can be proven to be non-mechanical in nature (i.e., telemetry dropouts). Such manipulation is always a last resort and should be conducted by an experienced analyst.

Modern vibration control systems produce drive signals with Gaussian amplitude distributions. Therefore, the block drop utility should be implemented to warn the analyst if a particular block is grossly non-Gaussian in nature. One possible approach is to calculate the Crest Factor, Skewness, and Kurtosis of each block, and warn the analyst if user defined threshold values were exceeded. The analyst should then have the option to accept or reject that block. If a data set is highly non-stationary or non-Gaussian in nature a TWR test may be recommended in lieu of a classical spectral based vibration test.

The number of averages comprising a given ASD may vary as a function of the event time. For statistical relevance, a minimum of thirty-two (32) valid data blocks is recommended for ASD calculation. For any event consisting of less than 32 averages after block drop, 50 percent overlap can be used to effectively double the number of blocks available.

2.4 Calculate ASD Average (Step 4).

Once the data blocks for processing are selected, a single-event ASD sum-set is generated for each channel and each event. A single-event ASD sum-set includes five ASDs, an average, peak hold, standard deviation, sum, and spectral spike removed, as defined in Table 514.8F-D.II. The first four ASDs of the sum-sets are calculated during Step 4. The average, denoted as ASD(Avg), is a standard n average ASD, where n is the number of data blocks selected for processing during block drop. Individual ASDs are calculated for each data block and then averaged on a spectral line basis to produce the ASD(Avg). The ASD(Sum) is calculated by adding N_e standard deviations to the ASD(Avg), where N_e is a user selected value typically set to 1. The ASD(Sum) becomes the working ASD and is passed forward to the next step. Use of the ASD(Sum) is intended to address severity variance across the vehicle fleet of interest. To minimize overly high ASD(Sum) levels, due for example to high standard deviations resulting from ground vehicle speed fluctuations, the ASD(Sum) is constrained to be no higher than $M_e * \text{ASD(Avg)}$ where M_e is a user defined parameter typically set to 2. The ASD(Sum) is also limited to the ASD(Peak) level at each spectral line. In the rare scenario in which there exists specific information as to how the vehicle being used to acquire the test data compares to the fleet, the Parameter N_e should be customized accordingly.

MIL-STD-810H
METHOD 514.8, ANNEX F, APPENDIX D

Table 514.8F-D.II. Single-Event ASD Sum-Set

Nomenclature	Definition
ASD(Avg)	A standard N_d average ASD. (See $G_m(f)$ as defined in Appendix B)
ASD(Peak)	Calculated by holding the maximum amplitude of each spectral line over N_d averages. (See $G_p(f)$ as defined in Appendix B)
ASD(Stdv)	Calculated by determining the standard deviation of each spectral line over n averages. (See $G_d(f)$ as defined in Appendix B)
ASD(Sum)	Calculated by adding N_e standard deviations to the average for each spectral line. $ASD(Sum) = N_e * ASD(Stdv) + ASD(Avg)$ N_e is a user defined variable typically set to 1. $ASD(Sum)$ is limited by $ASD(Peak)$ and $M_e * ASD(Avg)$ where M_e is a user defined variable typically set to 2. (See $G_s(f)$ as defined in Appendix B)
ASD(SpkRmvd)	ASD(Sum) after Frequency Spectral spike Removal.

2.5 Spectral spike Removal (Step 5).

For combined SOR or NBROR environments, the sine tones or narrowbands must be processed separately from the broadband random. Step 5 provides a method of removing the sine tones or narrowbands from the ASD(Sum) spectra when required.

To insure accuracy and to isolate unexpected inconsistencies in the data, the spectral spikes are selected and removed by the analyst acting interactively in a program loop using a graphical interface such as that shown in Figure 514.8F-D.2. The analyst selects the beginning and ending frequency of all spectral spikes for which removal is desired. Intermediate points are then replaced with a logarithmic interpolation of the two endpoints to produce the broadband ASD(SpkRmvd), shown as magenta in Figure 514.8F-D.2. This is the fifth ASD of the single-event ASD sum-set and becomes the working ASD for the broadband profile development.

Note that the width of the spectral spikes removed will depend on a number of factors, including, but not limited to, the nature of the data and the frequency resolution of the ASD calculations. Typically, the data should be pre-processed to determine if the data is more narrowband random or more sinusoidal in nature. This information determines how the narrow-band energy will be processed.

MIL-STD-810H
METHOD 514.8, ANNEX F, APPENDIX D

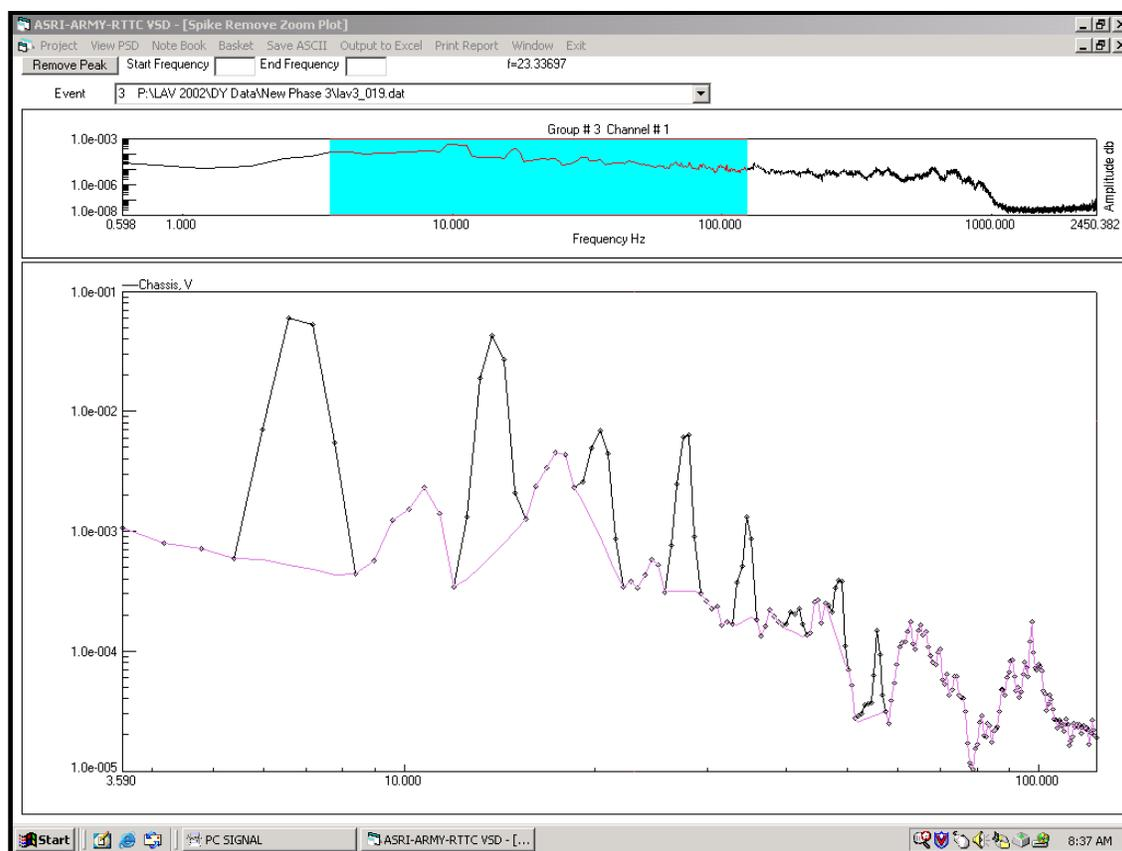


Figure 514.8F-D.2. Spectral spike removal window.

The nature of the vibration is dependent upon the vehicle and field environment. For example, an item mounted on a wheeled vehicle and driven on primary (paved) roads will be exposed to a broadband random forcing function. A wheeled vehicle driven over a periodic washboard course will typically produce a combined SOR vibration environment, as will a rotary wing aircraft. A tracked vehicle usually produces a combined NBROR vibration. The nature of the data (sine or narrowband) needs to be determined at this point. Refer to Annex F, paragraph 4 for more discussion on the nature of the vibration. Although the frequency resolution selected for ASD calculations will affect the width and amplitude of spectral spikes, it will not affect the total g-rms of the spectral spikes removed. For that reason the g-rms of the spectral spikes, rather than the ASD amplitude, should be used when processing the narrowband information.

The energy corresponding to the removed spectral spikes can be exported in a form that facilitates spreadsheet analysis. This allows external processing of the narrowband energy. Two spreadsheets should be produced. One containing the center frequency, width, and the total g-rms of all spectral spikes removed from all ASD(Sum); and another containing the same information from all ASD(Avg). The average numbers are used for SOR developments while the sum numbers are used for NBROR developments. The procedures used to process the narrowband information are presented in paragraph 3.

An example spectral spike removed spreadsheet is provided in Table 514.8F-D.III. The example contains the energies removed from the ASD(Avg). The ASD(Sum) table is identical except the g-rms levels are derived from the ASD(Sum) instead of the ASD(Avg). This particular example is of a wheeled vehicle on a two-inch washboard course. Note that the fundamental and two additional harmonics were removed from each of three events (5, 7.5, and 10 mph 2" washboard).

MIL-STD-810H
METHOD 514.8, ANNEX F, APPENDIX D

Table 514.8F-D.III. Spectral Spike Removed Table, Average

Project File :	Example Wheeled Vehicle							
Total Miles:	1000	Block size :	4096	Start Freq :	3	Raw ASD	W-UCol ASD	
Date Proc :	9/16/2002	Window Type :	Hann	End Frq :	500	N :	1	1
Time Proc :	6:37:44 AM	Min g-rms :	0.5	Rmv DC :	Y	M :	2	2
						Total G-RMS of removed Spectral spike		
Channel					1	2	3	
Description					Channel 1	Channel 2	Channel 3	
Type					ASD(Avg)	ASD(Avg)	ASD(Avg)	
Test Time					30	30	30	
	Event	Beta Dist Time	Center Freq	Bandwidth Selected	g-rms	g-rms	g-rms	
1 Harmonic	5 mph 2" WB	8.31	3.67	6	0.1534	2.79E-02	5.31E-02	
	7.5 mph 2" WB	21.28	5.50	5	0.2691	3.41E-02	0.134565	
	10 mph 2" WB	7.47	7.33	7	0.5755	8.74E-02	0.5730498	
2 Harmonic	5 mph 2" WB	8.31	7.33	6	0.1118	3.49E-02	7.37E-02	
	7.5 mph 2" WB	21.28	11.00	7	8.72E-02	3.22E-02	5.18E-02	
	10 mph 2" WB	7.47	14.67	6	8.98E-02	2.67E-02	0.211421	
3 Harmonic	5 mph 2" WB	8.31	11.00	6	0.06546	4.01E-02	9.12E-02	
	7.5 mph 2" WB	21.28	16.50	9	2.63E-02	2.94E-02	0.05846	
	10 mph 2" WB	7.47	22.00	8	3.08E-02	3.75E-02	0.07558	

2.6 Scenario Table (Step 6).

VSD requires knowledge of the exposure time for the individual events. For a ground vehicle, those times can be derived from the distribution of the system's mission scenario into the individual events through the use of a Beta distribution. For a helicopter, the scenario times are typically derived from the aircrafts usage spectrum. Further discussion of scenario development and the Beta distribution can be found in Annex F, paragraph 7.4.

The event times can be provided in the form of scenario tables populated in Step 6 of the process. An example scenario table is provided in Table 514.8F-D.IV. The weighting factors will be discussed further in paragraph 2.7. The example scenario table also includes a user input field for the slope to be used for time compression calculations. The remaining fields should be calculated by the software and contain the total g-rms levels of the ASD(SpkRmvd), over the user defined bandwidth of interest, for each channel of each event. For example, Column "1 GRMS" contains the g-rms levels for channel 1 for all events.

MIL-STD-810H
METHOD 514.8, ANNEX F, APPENDIX D

Table 514.8F-D.IV. Scenario Table Input

Event No	Event Name	Scenario Time	Weighted Factor Col	Weighted Factor Un-Col	1 GRMS	2 GRMS	3 GRMS
1	Radial Washboard 5 MPH	6.62	1	6.62	0.0327	0.0639	0.06
2	Radial Washboard 10 MPH	9.76	1	9.76	0.0686	0.1309	0.19
3	Radial Washboard 15 MPH	3.51	1	3.51	0.1289	0.2524	0.30
4	Embedded Rock 5 MPH	9.01	1	9.01	0.0532	0.1201	0.12
5	Embedded Rock 7.5 MPH	11.04	1	11.04	0.0858	0.1839	0.18
6	Embedded Rock 10 MPH	4.74	1	4.74	0.1246	0.2647	0.22
7	Belgian Block 5 MPH	1.05	1	1.05	0.0238	0.0512	0.04
8	Belgian Block 10 MPH	3.24	1	3.24	0.0443	0.0862	0.08
9	Belgian Block 15 MPH	5.18	1	5.18	0.0616	0.1077	0.12
10	Belgian Block 20 MPH	5.02	1	5.02	0.0825	0.1542	0.16
11	Belgian Block 25 MPH	1.88	1	1.88	0.1238	0.2285	0.23
Col Sum-Set GRMS					0.1289	0.2647	0.30

Double Click to Change value

From this point forward, only the events with a g-rms above a threshold selected by the analyst will be processed. The threshold was presented in Table 514.8F-D.I (Minimum g-rms) and is set as a ratio of the maximum g-rms, typically 0.50. As higher level vibration dominates fatigue exposure, the exclusion of lower level events will have little effect on the final test time. When selecting the threshold for event inclusion, the analyst must consider both the preservation of the spectral information of the lower level events and the effects their shape will have on the more dominate, high level events. The events with a g-rms above the threshold will be referred to as “included events”.

For each channel, the software should calculate the peak and average g-rms of the included events. The average becomes the base g-rms level utilized for processing. The base g-rms level will be the g-rms of the vibration profiles before final adjustment of test times is made.

The primary function of Step 6 (Scenario Table) is to calculate a vibration runtime associated with each event. The calculations are made using Equation 9-5, a standard method based on the Miner-Palmgren hypothesis for adjusting vibration spectra test times and levels. The slope (m) is typically set to a value of 7.5 for broadband random calculations. Further discussions of Miner’s Rule can be found in Annex F, paragraph 9.0.

MIL-STD-810H
METHOD 514.8, ANNEX F, APPENDIX D

An example runtime table is provided in Table 514.8F-D.V. Individual events (1-11) are given in rows and individual channels (1-7) are given in columns. Table 514.8F-D.V has been populated by the software using equation 9-5 and the input provided in the Table 514.8F-D.IV. Note that the events for which the g-rms (given in Table 514.8F-D.IV) was less than 50 percent of the maximum g-rms (for the same channel) are set to a value of zero. For example, the maximum g-rms for channel 1 in Table 514.8F-D.IV is 0.1289 g-rms. Six of the eleven events have a g-rms greater than 0.0644 (0.5×0.1289) as reflected by the entries in Table 514.8F-D.V. The weighed-average g-rms of the six included events for channel 1 is 0.09198 g-rms. Application of Equation 9-5 for event 2 of channel 1, with $G_1 = 0.0686$ (from Table 514.8F-D.IV), $G_2 = 0.09198$ (the weighted-average g-rms), $T_1 = 9.76$ minutes (scenario time for event 2) yields a runtime for channel 1 and event 2 of $T_2 = 1.0839$, which is reflected in the entry of Table 514.8F-D.V. The weighted rms is calculated by multiplying the scenario time by the associated g-rms. The weighted-average rms is the sum of the weighted g-rms values (for included events) divided by the sum of the scenario times (for included events). As all included events for a given channel are effectively normalized to the same g-rms level, the associated runtimes can simply be totaled to provide the overall runtime for that channel at that g-rms. The individual event run times are totaled in the row labeled TF in Table 514.8F-D.V. This total time is the run time required to provide equivalent broadband fatigue exposure to the system, assuming the broadband profile is also based on an average of the ASDs of the same group. The derivation of that average ASD will be discussed in paragraph 2.7.

Table 514.8F-D.V. Runtime Calculation

The screenshot shows a software window titled "Scenario Table" with a "Print Form" button. The window contains a table with the following data:

Event No	Event Name	Scenario Time	1 (Min)	2 (Min)	3 (Min)	4 (Min)	5 (Min)	6 (Min)	7 (Min)
1	Radial Washboard 5 MPH	6.62	0.0000	0.0000	0.0000	0.0000	0.0000	0.0000	0.0000
2	Radial Washboard 10 MPH	9.76	1.0839	0.0000	7.5042	1.4266	0.0000	5.0242	0.0000
3	Radial Washboard 15 MPH	3.51	44.0730	16.5723	67.7850	42.9182	31.0571	17.1557	33.4061
4	Embedded Rock 5 MPH	9.01	0.0000	0.0000	0.0000	0.0000	0.0000	0.0000	0.6444
5	Embedded Rock 7.5 MPH	11.04	6.5395	4.8474	4.7421	6.0680	3.1819	0.0000	21.3750
6	Embedded Rock 10 MPH	4.74	46.1231	31.9828	10.4189	34.8946	6.6298	0.0000	38.8000
7	Belgian Block 5 MPH	1.05	0.0000	0.0000	0.0000	0.0000	0.0000	0.0000	0.0000
8	Belgian Block 10 MPH	3.24	0.0000	0.0000	0.0000	0.0000	0.0000	0.0000	0.0000
9	Belgian Block 15 MPH	5.18	0.0000	0.0000	0.0000	0.0000	0.0000	0.0000	0.8444
10	Belgian Block 20 MPH	5.02	2.2310	0.5887	0.9003	2.5947	3.1033	0.0000	2.8944
11	Belgian Block 25 MPH	1.88	17.4201	4.2217	6.0418	16.9478	14.9296	0.0000	6.8111
	TF		117.4706	58.2131	97.3924	104.8499	58.9017	22.1799	104.7911
	TFA		60	30	60	30	30	15	60

At the bottom of the window, there is a text input field containing "60", an "Update" button, and a label "TFa=TF".

MIL-STD-810H
METHOD 514.8, ANNEX F, APPENDIX D

2.7 Calculate Weighted ASD (Step 7).

Steps 7 and 8 are used to complete the LVTS development process. At this point in the development process, an ensemble of single-event ASD sum-sets has been generated and consists of a sum-set for each channel of each event. The fifth ASD of the sum-set, the spectral spike removed ASD, is the working ASD for the VSD process. The multiple ASD(SpkRmvd) of a given channel (one for each event) must be combined to produce the broadband profile for that channel. The ASDs are combined using the methods discussed in the following paragraphs to produce a “group sum-set”. The group sum-set, similar to the single-event ASD sum-set, includes a number of ASDs as defined in Table 514.8F-D.VI.

Table 514.8F-D.VI. Group Sum-Set Definition

ASD(Avg_g)	The weighted average of the ASD group. See Equation D.2-1. (See $G_a(f)$ as defined in Appendix B)
ASD(Peak_g)	Calculated by holding the maximum amplitude of each spectral line over all events.
ASD(Stdv_g)	The weighted standard deviation of the ASD group. See Equation D.2.2-3. (See $G_e(f)$ as defined in Appendix B)
ASD(Sum_g)	Calculated by adding N_g standard deviations to the average for each spectral line. $ASD(Sum_g) = N_g * ASD(Stdv_g) + ASD(Avg_g)$ Calculated by adding N_g standard deviations to the average for each spectral line. $ASD(Sum) = N_e * ASD(Stdv) + ASD(Avg)$ N_g is a user defined variable typically set to 1. $ASD(Sum)$ is limited by $ASD(Peak)$ and $M_g * ASD(Avg)$ where M_g is a user defined variable typically set to 2. (See $G_f(f)$ as defined in Appendix B “for $N=1$ ”)
ASD(Final)	The $ASD(Sum_g)$ scaled to a user selected final time.

The ASDs of the group sum-set, as with the single-event ASD sum-set, are calculated on a spectral line basis. The $ASD(Avg_g)$ is an average of the $ASD(SpkRmvd)$ for all events in the group (excluding those for which the g-rms is below the user defined threshold). Unlike the $ASD(Avg)$ of the single-event ASD sum-set, the $ASD(Avg_g)$ is not a standard n average ASD. Instead, the individual ASDs are weighted to the factors defined in the scenario table (see Table 514.8F-D.IV). Typically, the weighting factors are set equal to the individual event scenario times. The idea of a weighted approach is to produce a time-based calculation instead of an event-based calculation. In effect, weighting to the scenario time produces a separate ASD for each minute of the lifecycle, instead of an ASD for each event. Each minute of the system’s lifecycle would then be weighted equally in determining the average. A similar method is used to calculate the standard deviation of the group $ASD(Stdv_g)$.

Assuming there are n events that exceed the minimum g-rms, that W_i is weighting factor of each event, and that G_i is the g^2/Hz level of each event, then for each spectral line:

$$ASD(Avg_g) = \frac{\sum_{i=1}^n W_i G_i}{\sum_{i=1}^n W_i} \quad D.2-1$$

MIL-STD-810H
METHOD 514.8, ANNEX F, APPENDIX D

$$ASD(Stdv_g) = \sqrt{\frac{\sum_{i=1}^n W_i * [G_i - ASD(Avg_g)]^2}{\sum_{i=1}^n W_i}} \quad D.2-2$$

The ASD(Sum_g) is calculated by adding N_g standard deviations to the average, where N_g is a user defined variable typically set to 1. Use of the ASD(Sum_g) is intended to account for factors such as differences in road surfaces, driver variances, and consideration of road surfaces not included in the data acquisition phase and other relevant variables. The ASD(Sum_g) is constrained to be no higher than $M_g * ASD(Avg_g)$ where M_g is a user defined parameter with a default value of 2.0. The ASD(Sum_g) is also limited to the ASD(Peak_g) level at each spectral line. Although some additional processing may be required, the ASD(Sum_g) coupled with the runtime calculated in the previous step now represent the equivalent lifetime fatigue of an item mounted at that location. Recall that each channel represents a vibration axis for a given location. The ASD(Sum_g) becomes the working ASD and is passed forward to the next step.

In some cases multiple channels (or locations) must be combined into a single LVTS. This can be accomplished by simply enveloping the channels later in the VSD process. However, it is possible to combine multiple channels concurrently with the event combination. Assuming j is a list of m channels to combine, then for each spectral line:

$$ASD(Avg_g) = \frac{\sum_{j=1}^m \sum_{i=1}^n W_{ij} G_{ij}}{\sum_{j=1}^m \sum_{i=1}^n W_{ij}} \quad D.2-3$$

$$ASD(Stdv_g) = \sqrt{\frac{\sum_{j=1}^m \sum_{i=1}^n W_{ij} * [G_{ij} - ASD(Avg_g)]^2}{\sum_{j=1}^m \sum_{i=1}^n W_{ij}}} \quad D.2-4$$

2.8 Calculate Weighted Intermediate LVTS (Step 8).

The next step in the development of the broadband vibration profile is to adjust the run time. The software should allow the analyst to select the runtime for each channel. In the example of Table 514.8F-D.V, the runtime for each channel is shown in the TFA field. Runtimes are typically adjusted to round the times calculated by the software to even time increments or to exaggerate the test schedule when desired. Care must be taken to assure the final LVTS levels do not overly exceed the maximum levels measured in the field and that exaggeration, if used, is not excessive. See Annex F, paragraph 9.2.1.2 for a discussion of limiting exaggeration. Step 8 simply applies Equation 9.5 to scale the ASD(Sum_g) to the user selected runtime, producing the final broadband ASD, ASD(Final).

Depending on the control methods used, further processing may be required. For SOR control the broadband profile must be combined with the sine tone information. It may also be necessary to combine the profiles of several channels into a single LVTS. At this point it is helpful to export the ASD(Final) in a form that facilitates spreadsheet analysis. This allows ease of processing for multi-channel combination, recombining with narrowband or sine tone, changes in runtime, or other specialized processing.

Note that an alternate method of combining the broadband profiles of multiple events into a representative LVTS is discussed in paragraph 7. This alternate method would begin with the ASD(SpkRmvd) and would produce an alternate ASD(Final).

MIL-STD-810H
METHOD 514.8, ANNEX F, APPENDIX D**3. NARROWBAND RANDOM SPECIFICATION DEVELOPMENT PROCEDURE.**

To allow greater flexibility in adapting to project specific requirements, the narrowband or sine tones removed from the broadband (see paragraph 2.5) can be processed in a spreadsheet. A sample narrowband random spreadsheet is provided in Table 514.8F-D.VII. The sample is of a wheeled vehicle on the 2-inch Washboard Course. Three tones were removed from each of three events (5, 7.5 and 10 mph). Note that sinusoidal processing, rather than narrowband random, would generally be used for a wheeled vehicle on the 2-Inch Washboard Course. The example is used for ease of discussion only, and will not affect the description of the process.

The following definitions provide a column-by-column description of the narrowband random processing procedures.

3.1 Event (Col. A) – This column lists the events and tones (or harmonics) removed from the broadband.

3.2 Speed on 2" WB (Col. B) – This column contains the ground speed of the given event.

3.3 Center Frequency Selected (Col C.) – The center frequencies of the narrowbands of interest may be set to the center frequencies of the narrowbands removed during spectral spike removal. However, it might be desirable to calculate the center frequency. For example, the center frequencies of a wheeled vehicle on a periodic course may be affected by slight changes in vehicle speed or the frequency resolution of ASD calculations. For proper control on an exciter table the tones must be harmonically related and are best set to the frequencies that would have resulted given ideal conditions. For a wheeled vehicle the frequencies can be calculated using the vehicle speed and the displacement of the periodic input (i.e., washboards spaced 0.6 meters apart). For a helicopter the frequencies can be set to the known blade passing frequency. Care should be taken to assure that the center frequency calculated does not vary significantly from the actual center frequency measured.

3.4 Test Time from Adjusted Beta Distribution (Col. D) – Generally, this column contains the times as calculated during scenario development (see Annex F, paragraph 7.1). However, the field is labeled “Adjusted” because it is sometimes necessary to combine the narrowbands of multiple events. For example, with a rotary wing aircraft the tones for all events are generally at the same frequencies (driven by the main rotor). A similar case results for narrowbands associated with tracked vehicles driven over multiple terrain types at the same speed. During processing, all narrowbands of like frequency must be combined into a single narrowband containing the combined energy of the group. Equation 9.1 or Equation 9.5 can be used to adjust the scenario times such that the g-rms of the individual narrowbands are normalized to some common g-rms, typically the maximum g-rms of the group. The adjusted test times of the individual tones (now all at the same g-rms level) are then totaled. This time is then entered into Column D of the narrowband table.

3.5 Actual Test Time (Col. E.) – This is the portion of the runtime for which the given narrowband will be within the given frequency region. Depending on the nature of the source vibration, the narrowbands will either dwell at a single frequency (i.e., helicopter) or sweep over a range of frequencies (i.e., tracked vehicle). In the case of sweeping narrowbands, the total run time selected by the analyst must be distributed across the sweep bandwidth, or the multiple narrowband breakpoints. The time is generally distributed equally between the multiple test points, with the two end points set to one half the time of the other points. See Annex F, paragraph 7.1 for an explanation of why the endpoints are treated differently.

3.6 Narrowband Bandwidth Selected (Col. F) – This field provides the width of each narrowband for vibration control. Note that the bandwidths of harmonically related tones must also be harmonically related. The bandwidth can be established through a study of the individual events using pre-processing software.

3.7 Total g-rms of Tone ASD(Sum) (Col. G) – This field contains the g-rms of the narrowband energy removed from the ASD(Sum). In the case where multiple narrowbands must be combined, as discussed in paragraph 3.4, this number is the normalized g-rms used to combine the group.

3.8 Bandwidth Normalized g-rms (ASD) (Col. H.) – Modern control systems generally control to a ASD spectrum. Therefore, the g-rms values of the tones must be converted into ASD format. This is done by squaring the g-rms of Column G and dividing by the bandwidth of Column F, resulting in the g^2/Hz level of Column H. This g^2/Hz level represents the test level, before conservatism, associated with the test times of Column D.

MIL-STD-810H
METHOD 514.8, ANNEX F, APPENDIX D

Table 514.8F-D.VII. Narrowband Random Calculations

A	B	C	D	E	F	G	H	I	J	K	L
Tone Information					Narrowband Calculations						
Event	Speed on 2" WB	Center Freq Selected	Test Time from Adj Beta Dist	Actual Test Time	Narrowband Bandwidth Selected	Total g-rms of Tone ASD(Sum)	BandWidth Normalized g-rms (ASD)	ASD Adjusted to Test Time	Random Test Level	Ratio Adjusted to Normalized	Ratio Check
TONE 1 INFO											
5 mph 2" WB	5	3.67	55.41	30	2.5	2.67E-01	2.84E-02	3.35E-02	4.69E-02	1.18	
7.5 mph 2" WB	7.5	5.50	141.88	60	2.5	2.92E-01	3.42E-02	4.30E-02	6.02E-02	1.26	
10 mph 2" WB	10	7.33	49.80	30	2.5	4.77E-01	9.12E-02	1.04E-01	1.46E-01	1.14	
TONE 2 INFO											
5 mph 2" WB	5	7.33	55.41	30	5	1.13E-01	2.57E-03	3.03E-03	4.24E-03	1.18	
7.5 mph 2" WB	7.5	11.00	141.88	60	5	3.45E-01	2.38E-02	3.00E-02	4.20E-02	1.26	
10 mph 2" WB	10	14.67	49.80	30	5	3.72E-01	2.77E-02	3.18E-02	4.45E-02	1.14	
TONE 3 INFO											
5 mph 2" WB	5	11.00	55.41	30	7.5	2.67E-01	9.50E-03	1.12E-02	1.57E-02	1.18	
7.5 mph 2" WB	7.5	16.50	141.88	60	7.5	1.69E-01	3.80E-03	4.78E-03	6.69E-03	1.26	
10 mph 2" WB	10	22.00	49.80	30	7.5	2.41E-01	7.77E-03	8.89E-03	1.25E-02	1.14	

MIL-STD-810H
METHOD 514.8, ANNEX F, APPENDIX D

3.9 ASD Adjusted to Test Time (Col. I) – The g^2/Hz level of Column H is adjusted using Equation 9-5 to account for the difference in the scenario time (Column D) and the actual test time (Column E). A value of $m= 7.50$ is generally used when the engineering units are g^2/Hz .

3.10 Random Test Level (Col. J) - The g^2/Hz levels of Column I are scaled by a conservatism factor, generally 1.4, resulting in the narrowband random test levels of Column J. The conservatism factor is intended to account for variations in level due to differences in road conditions, road conditions not considered, drivers, pilots, weather conditions, and other relevant variables. These are the final narrowband test levels that will be included in the LVTS.

3.11 Ratio Adjusted to Normalized (Col. K) – This column contains the ratio of the “ASD adjusted to test time” to the “bandwidth normalized ASD levels” (Column I / Column H). This is to assure that excessive exaggeration has not been applied. Observe that commercially available vibration control systems currently restrict sweep rates to be either linear or logarithmic which, unfortunately, is generally not typical of most mission scenarios (i.e., refer to the shape of the speed distribution produced by a beta distribution). Forcing the narrowbands to sweep in either a linear or logarithmic manner will require magnitudes to be modified via Equation 9-5 as discussed in Annex F, paragraph 9. The analyst will need to be cautious in addressing the amount of time compression during this process. Column K in the example spreadsheet provides a quick visual check of compression employed in development of the narrowband portion of the spectrum.

3.12 Ratio Check (Col. L) – If the ratio if Column K exceeds a user selected factor, a flag is set in column L warns the analyst. Annex F, paragraph 9 recommends a limit factor of 2.0 when considering ASD (g^2/Hz) levels. In the event the ratio check indicates excessive scaling it may be helpful to divide the LVTS into multiple LVTS that each sweep over some portion of the full range. This will allow adjustment of the distribution of time into the separated ranges, but will increase the number of LVTS’s required to represent the LCEP of interest. There will generally be some level of engineering judgment required during this phase of a LVTS development. For example, following the guidance of not increasing the ASD levels via time compression techniques by more than 2:1 is still viable for the higher level narrowbands or at any frequency known to be critical to the payload or carrier vehicle. However, if a low amplitude harmonic not associated with a critical frequency exceeds the 2:1 criteria for a limited portion of a sweep one could consider making an exception. For cases in which time compression techniques of the narrowbands result in excessive deviation from the 2:1 criteria, the analyst may be required to break the LVTS into multiple LVTS developments in which a finer breakdown of the mission scenario is addressed (i.e., develop a low, medium, and high speed LVTS per axis). One should also use caution to ensure that the ratio is no less than 1:1 for the higher level narrowbands or at any frequency known to be critical to the payload or carrier vehicle.

3.13 Tracked Vehicle Considerations.

The division into multiple LVTS discussed in the previous paragraph may be particularly helpful in the case of tracked vehicles. For tracked vehicles, the narrowband center frequency is a function of the vehicle speed. It may be possible to have a single broadband that represents all speeds, and to sweep the narrowband in a single sweep that encompasses all relevant speeds. However, if the broadband level changes significantly as a function of speed it may be desirable to split the multiple speeds into two or more LVTS, each of which include a given speed range.

4. SINE TONE SPECIFICATION DEVELOPMENT PROCEDURE.

The procedures for sine tone development are similar to those for narrowband random development. A sample sine tone spreadsheet is provided in Table 514.8F-D.VIII. The sample is of the same wheeled vehicle on the 2-Inch Washboard Course as the narrowband random example. Three tones were removed from each of three events (5, 7.5 and 10 mph). The following paragraphs provide a column-by-column description of the sine tone processing procedures.

MIL-STD-810H
METHOD 514.8, ANNEX F, APPENDIX D

Table 514.8F-D.VIII. Sine Tone Calculations

A	B	C	D	E	F	G	H	I	J	K	L	M	N	O
Tone Information						Sine Tone Calculations								
Event	Speed on 2" WB	Sine Tone Freq Selected	Test Time from Adj Beta	Actual Test Time	Total g-rms of Tone ASD(Avg)	Sine G-Peak	Sine Peak Adjusted to Test Time	Sine Test Level	MAX Disp (inch Pk-Pk)	Disp Warn	Max Vel in/sec	Raw Data Vel	Ratio Adj Peak	Ratio Check
TONE 1 INFO														
5 mph 2" WB	5	3.67	55.41	30	0.218	3.09E-01	3.40E-01	4.08E-01	0.59		6.8	5.17	1.10	
7.5 mph 2" WB	7.5	5.50	141.88	60	0.245	3.47E-01	3.98E-01	4.78E-01	0.31		5.3	3.88	1.15	
10 mph 2" WB	10	7.33	49.80	30	0.406	5.74E-01	6.22E-01	7.47E-01	0.27		6.3	4.81	1.08	
TONE 2 INFO														
5 mph 2" WB	5	7.33	55.41	30	0.089	1.25E-01	1.38E-01	1.66E-01	0.06		1.4	1.05	1.10	
7.5 mph 2" WB	7.5	11.00	141.88	60	0.244	3.45E-01	3.96E-01	4.75E-01	0.08		2.7	1.93	1.15	
10 mph 2" WB	10	14.67	49.80	30	0.294	4.16E-01	4.51E-01	5.42E-01	0.05		2.3	1.74	1.08	
TONE 3 INFO														
5 mph 2" WB	5	11.00	55.41	30	0.192	2.72E-01	3.00E-01	3.60E-01	0.06		2.0	1.52	1.10	
7.5 mph 2" WB	7.5	16.50	141.88	60	0.121	1.71E-01	1.96E-01	2.35E-01	0.02		0.9	0.64	1.15	
10 mph 2" WB	10	22.00	49.80	30	0.173	2.44E-01	2.65E-01	3.17E-01	0.01		0.9	0.68	1.08	

MIL-STD-810H
METHOD 514.8, ANNEX F, APPENDIX D

- 4.1 Event (Col. A) – Same as paragraph 3.1.
- 4.2 Speed on 2” WB (Col. B) – Same as paragraph 3.2.
- 4.3 Sine Tone Frequency Selected (Col. C) – Same as paragraph 3.3, except instead of the center frequency of a narrowband tone it is a single frequency of a sine tone.
- 4.4 Test Time from Adjusted Beta Distribution (Col. D) – Same as paragraph 3.4.
- 4.5 Actual Test Time (Col. E) - Same as paragraph 3.5.
- 4.6 Total g-rms of Tone ASD(Avg) (Col. F) – Same as paragraph 3.7, except the g-rms comes from the ASD(Avg). The average ASD is used for sinusoidal data to prevent artificially high standard deviations from affecting the final test levels. If a spectral spike is truly sinusoidal, the standard deviation at the frequency of the spectral spike should be nearly zero. However, for ground vehicles, fluctuations in vehicle speed can result in errors in standard deviation calculations as the spectral spikes move with vehicle speed.
- 4.7 Sine G-Peak (Col. G) – For sinusoidal data, the g-rms values of Column F are simply converted to g-peak levels by multiplying by $\sqrt{2}$.
- 4.8 Sine Peak Adjusted to Test Time (Col. H) - The g-peak level of Column G is adjusted using Equation 9.1 to account for the differences in the scenario time (Column D) and the actual test time (Column E). A slope of $m=6.29$ is generally used when the units are in g-peak.
- 4.9 Sine Test Level (Col. I) - The g-peak levels of Column H are scaled by a conservatism factor, generally 1.2, resulting in the sine test levels of Column I. The conservatism factor is intended to account for variations in level due to differences in road conditions, road conditions not considered, drivers, pilots, weather conditions, and other relevant variables. These are the final sine test levels that will be included in the LVTS.
- 4.10 Max Displacement (inch Pk-Pk) (Col. J) – This is the displacement in inches, peak to peak, for a sine tone with a frequency of Column C and a level of Column I.
- 4.11 Displacement Warning (Col. K) – If the displacement calculated in Column J exceeds a user defined level, typically 1.5 inches, the analyst is flagged by this column.
- 4.12 Max Velocity in/sec (Col. L) – This is the maximum velocity resulting for the given test level. Care should be taken to assure the velocity levels do not exceed hardware capabilities.
- 4.13 Raw Data Velocity (Col. M) – This is the velocity based on the raw data measured in the field. This is provided to the analyst as a comparison point to the final velocity.
- 4.14 Ratio Adjusted Peak to Peak (Col. N) – This column is the ratio of the “sine peak adjusted to test time” to the “Sine G Peak” (Column H / Column G). This is to assure that excessive exaggeration has not been applied. Observe that commercially available vibration control systems currently restrict sweep rates to be either linear or logarithmic which, unfortunately, is generally not typical of most mission scenarios (i.e., refer to the shape of the speed distribution produced by a beta distribution). Forcing the sine tones to sweep in either a linear or logarithmic manner will require magnitudes to be modified via Equation 9-1 as discussed in Annex F, paragraph 9. The analyst will need to be cautious in addressing the amount of time compression during this process. Column O in the example spreadsheet provides a quick visual check of compression employed in development of the narrowband portion of the spectrum.
- 4.15 Ratio Check (Col. O) - If the ratio if Column N exceeds a user selected factor, a flag is set in column O warns the analyst. Exaggeration limits are discussed in Annex F, paragraph 9. In the event the ratio check indicates excessive scaling it may be helpful to divide the LVTS into multiple LVTS that each sweep over some portion of the full range. This will allow adjustment of the distribution of time into the separated ranges, but will increase the number of LVTS’s required to represent the LCEP of interest. Additional information on this topic can be found in paragraph 3.12.

5. ALTERNATE BROADBAND DEVELOPMENT BASED ON FATIGUE DAMAGE SPECTRUM.

One method to develop a LVTS ASD(Final) and associated runtime was presented in paragraphs 2.6 to 2.8. An alternative approach could be derived from the Fatigue Damage Spectrum methods discussed in Appendix C.

MIL-STD-810H
METHOD 514.8, ANNEX F, APPENDIX D

6. FINAL DEVELOPMENT PROCEDURES.

The final stages of the VSD process can be completed in a spreadsheet file. Most procedures required to complete the VSD process, including the narrowband calculations presented in previous sections, can be incorporated into a spreadsheet package. The advantages of using a pre-developed spreadsheet, which has been heavily scrutinized, include: the elimination of errors that can occur during spreadsheet development, drastic reduction in development time, standardization of the VSD process, and the flexibility to incorporate project specific modifications.

A primary function of the spreadsheet should be to combine co-located channels into a single LVTS. Typically, this is accomplished by enveloping the multiple broadband profiles to create a single maxi-profile. Likewise, the sine or broadband levels of the multiple channels are enveloped. Since the maximum levels of the multiple development accelerometer channels become the final LVTS, maxi-control of multiple control accelerometers (located as similarly as possible to the corresponding development channels) is generally recommended.

The spreadsheet, or supporting software, should allow the analyst to select breakpoints. The original vibration profile includes a point for every spectral line over the full bandwidth. Breakpoints allow the shape and energy of the vibration profile to be represented with a minimal number of points. The breakpoints should match the shape and level of the original profile as closely as possible, particularly at frequencies near a system resonance. It might be desirable to scale the breakpoints such that the g-rms of the breakpoints equals that of the original profile. Care should be taken to assure scaling does not overly affect the ASD levels at frequencies of concern.

Other functions that could be included in the spreadsheet are: the ability to adjust the LVTS run time; checks to assure data accuracy and reduce development errors; calculations of broadband, narrowband, and sine tone parameters such as g-rms, displacement, velocity and sweep rates; combination of the broadband profile with the narrowband or sine tone profiles; and the presentation of data for review or for final publication.

As published, the final LVTS should include all information necessary to run the test in a laboratory. This information should include the control method, broadband breakpoints, the narrowband or sine tone breakpoints (if needed), control locations, control tolerances, runtime, sweep rates, sweep mode (logarithmic or linear), and any other required information.

Final LVTS's should be reviewed extensively to ensure the accuracy of the development process. One helpful tool for review is an overlay the final LVTS profile with the single-event ASDs of the measured field data. Gross errors in the development process are easily identified by the overlay. Other methods utilized during review include a comparison of like channels, a comparison to LVTS of similar vehicles, a comparison of input and response LVTS, a search for outliers, and a step-by-step review of the process.

7. COMBINING LVTS.

It is sometimes necessary to combine multiple LVTS into one. This can be due to the need to combine the exposure of more than one vehicle, or the desire to combine multiple LVTS developed for a single vehicle. For ASD's with similar spectral shapes, the following method can be used to combine the broadband portions of two or more LVTS. Refer to Table 514.8F-D.IX for an example of the calculations for combining two LVTS, LVTS01 and LVTS02. Note that each LVTS will consist of an ASD and an associated runtime. For the example assume LVTS01 Runtime = 30 min; LVTS02 Runtime = 15 min; Final Runtime = 20 min. First, Miner's Rule is utilized to perform a spectral line-by-spectral line scaling of each LVTS to some normalized level. In the example each spectral line is normalized to the value of LVS02. This process assigns new test times to each spectral line of each LVTS. Once the power levels of the LVTS are equated, the individual times can simply be totaled on a spectral line basis. At this point a new combined LVTS has been created, LVTS_C. However, each spectral line has a varying associated test time. For the final step, the levels for each spectral line are scaled using Equation 9-5 such that all spectral lines are normalized to a final runtime selected by the analyst. A similar approach can be utilized to combine narrowbands or sine tones.

MIL-STD-810H
METHOD 514.8, ANNEX F, APPENDIX D

Table 514.8F-D.IX. LVTS Combination Example

Freq (Hz)	LVTS01 (G ² /Hz)	LVTS02 (G ² /Hz)	Norm Level (G ² /Hz)	LVTS01 New Time (min)	LVTS02 New Time (min)	Total New Time (min)	Final Run Time (min)	LVTS_C (G ² /Hz)
5	0.100	0.200	0.200	2.23	15.00	17.23	20.00	0.208
6	0.200	0.400	0.400	2.23	15.00	17.23	20.00	0.415
7	0.300	0.400	0.400	10.20	15.00	25.20	20.00	0.459
8	0.400	0.400	0.400	30.00	15.00	45.00	20.00	0.536
9	0.400	0.300	0.300	88.24	15.00	103.23	20.00	0.501

This method can also be used this to combine multiple events into a broadband LVTS, replacing the steps outline in paragraphs 2.6 through 2.8 above. An alternate method to add conservatism must be found, and care should be taken to assure the method does not corrupt the overall shape of the ASD set. Refer to paragraph 2.2.1 (main body of Method 514) for cautions associated with combining LVTS.

MIL-STD-810H
METHOD 514.8, ANNEX F, APPENDIX D

(This page is intentionally blank.)

MIL-STD-810H
METHOD 514.8, ANNEX F, APPENDIX E

METHOD 514.8, ANNEX F, APPENDIX E
Theoretical Aspects of Maximum Response

1. INTRODUCTION.

When a vibration excitation is applied to a mechanical system with one degree of freedom, the maximum value of the response of this system for a deterministic signal, or the probability of a maximum value for a random signal, can be calculated. This value is called the 'maximum' or the 'extreme' value. The maximum response spectrum is the curve that represents variations of the 'maximum' response value as a function of the natural frequency of the system with one degree of freedom, for a given damping factor ξ .

2. SINUSOIDAL EXCITATION.

Given a sinusoidal excitation with the form:

$$\ddot{x}(t) = \ddot{x}_m(t) \sin(2\pi ft)$$

The relative response displacement $z(t)$ of a linear system with one degree of freedom is expressed:

$$z(t) = \frac{-\ddot{x}(t)}{\omega_0^2 \left\{ \left[1 - \left(\frac{f}{f_0} \right)^2 \right]^2 + 4\xi^2 \left(\frac{f}{f_0} \right)^2 \right\}^{\frac{1}{2}}}$$

For given values for f and f_0 , $z(t)$ is a maximum when $\ddot{x}(t) = \ddot{x}(m)$:

$$MRS = \omega_0^2 z(t) = \frac{-\ddot{x}(m)}{\left\{ \left[1 - \left(\frac{f}{f_0} \right)^2 \right]^2 + 4\xi^2 \left(\frac{f}{f_0} \right)^2 \right\}^{\frac{1}{2}}}$$

The MRS is the curve representing the variations of $\omega_0^2 Z_m$ versus f_0 , for given value of ξ . The positive and negative spectra are symmetric. The positive spectrum goes through a maximum when the denominator goes through a minimum, i.e.:

$$MRS = \frac{\ddot{x}_m}{2\xi\sqrt{1-\xi^2}}$$

As an initial approximation, it can be considered that:

$$MRS = Q\ddot{x}_m$$

Example: MRS for a fixed sine excitation at 500 Hz with $Q=5$ (Figure 514.8F-E.1).

MIL-STD-810H
METHOD 514.8, ANNEX F, APPENDIX E

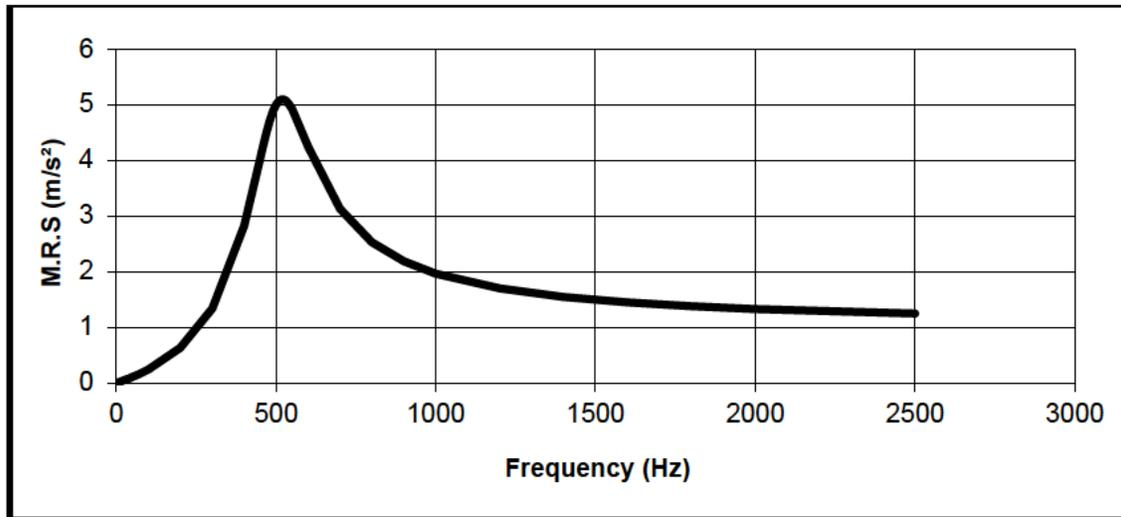


Figure 514.8F-E.1. MRS for a fixed sine excitation at 500 Hz with $Q=5$.

3. SWEEPED SINE EXCITATION.

The MRS is extrapolated from the MRS of fixed sinusoidal signals at frequencies corresponding to the limits of the domain of sweeping.

Example: MRS for a swept sine from 300 Hz to 1200 Hz (Figure 514.8F-E.2).

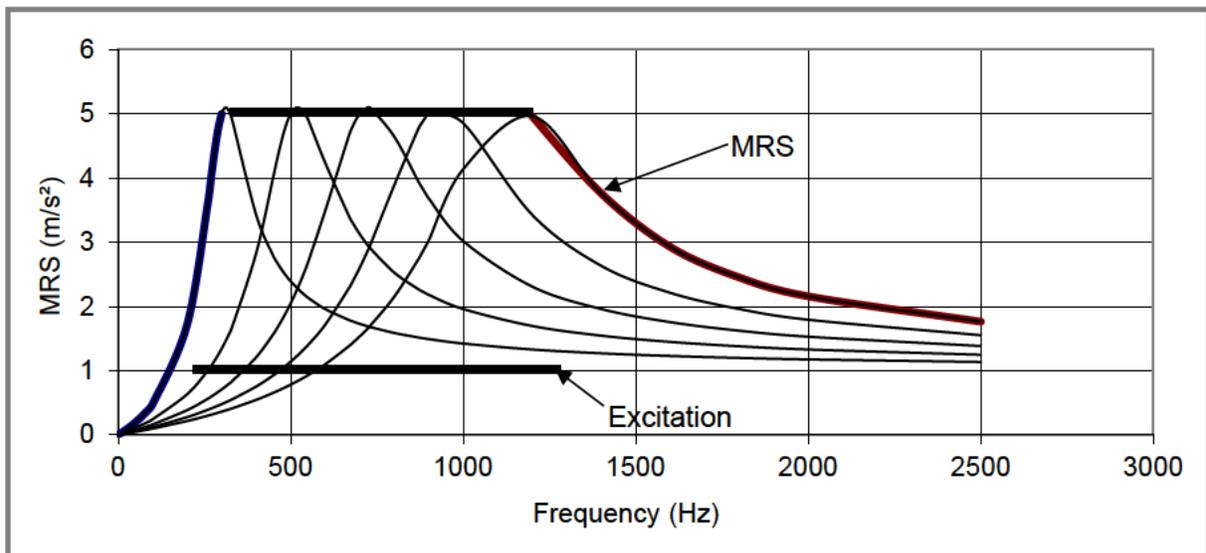


Figure 514.8F-E.2. MRS for a swept sine from 300 Hz to 1200 Hz.

4. RANDOM VIBRATION EXCITATION.

The MRS is calculated by considering the average number of times a threshold of the response $z = a$ is exceeded with a positive slope for a time T . This number is given by the following equation for a Gaussian vibration:

$$N_a^+ = n_a^+ T = T e^{-\frac{a^2}{2\pi_{\text{eff}}^2}}$$

MIL-STD-810H
METHOD 514.8, ANNEX F, APPENDIX E

Considering a threshold which is exceeded only once on the average, and setting $N_a^+ = 1$

$$a = z_{\text{eff}} \sqrt{2 \ln(n_0^+ T)}$$

which provides:

$$R = 4 \pi_2 f_0^2 z_s = 4 \pi_2 f_0^2 z_{\text{eff}} \sqrt{2 \ln(n_0^+ T)}$$

Example: MRS for a random vibration (Figure 514.8F-E.3) defined by:

100 – 300 Hz	0.5 g ² /Hz
300 – 600 Hz	1 g ² /Hz
600 – 1200 Hz	0.2 g ² /Hz
Q = 10	

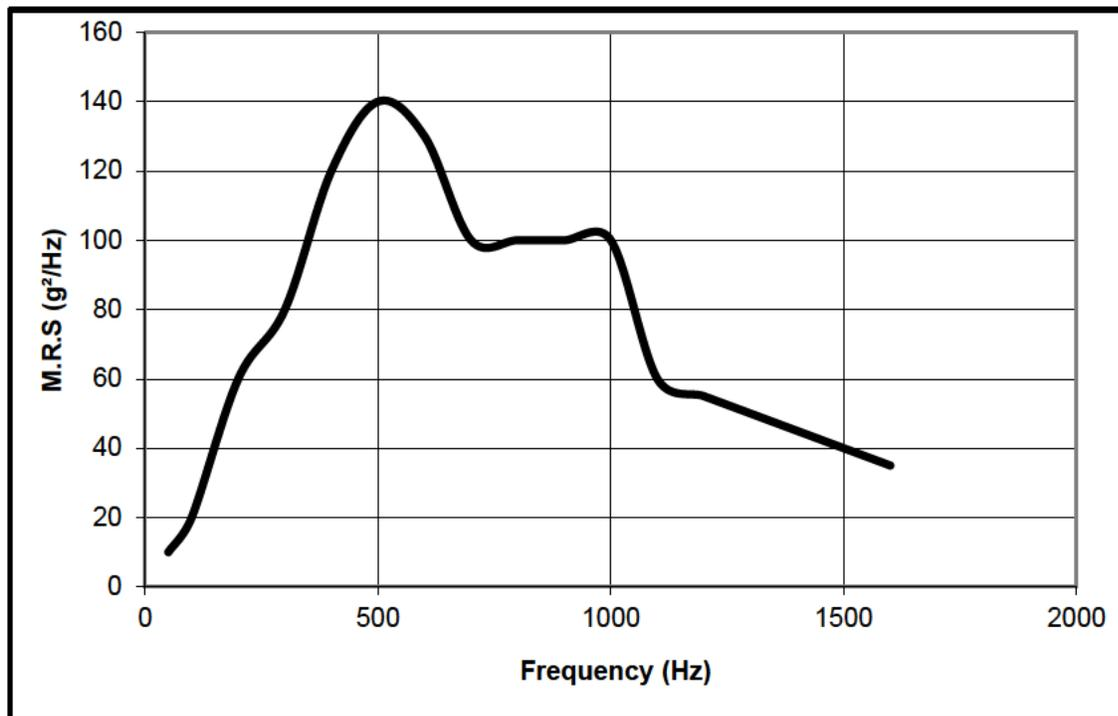


Figure 514.8F-E.3. MRS for a random vibration.

MIL-STD-810H
METHOD 514.8, ANNEX F, APPENDIX E

(This page is intentionally blank.)

MIL-STD-810H
METHOD 514.8, ANNEX F, APPENDIX F**METHOD 514.8, ANNEX F, APPENDIX F****References**

- a. NATO Allied Environmental Conditions and Test Publication (AECTP) 100 Environmental Guidelines For Defence Materiel, Edition 4; May 2009
- b. International Test Operating Procedure (ITOP) 1-1-050. Development of Laboratory Vibration Test Schedules. 6 June 1997. DTIC AD No B227368
- c. Test Operations Procedure (TOP) 01-2-601, Ground Vehicle Laboratory Vibration Schedules. 18 May 2015.
- d. Harris, Cyril M., Allan G. Piersol, , Shock and Vibration Handbook, McGraw-Hill Book Company, Fifth Edition, ISBN 0-07-137081-1, 2002
- e. Bendat, Julius S., Allan G. Piersol, Random Data Analysis and Measurement Procedures Wiley Interscience, Third Edition, ISBN 978-0-471-31733-3, 2000.
- f. Henderson, George R. and Allan G. Piersol, Fatigue Damage Related Descriptor for Random Vibration Test Environments, Sound and Vibration, October 1995.
- g. Piersol, Allan G., Determination of Maximum Structural Responses From Predictions or Measurements at Selected Points, Proceedings of the 65th Shock and Vibration Symposium, Volume I, SAVIAC, 1994. Shock and Vibration Exchange; 1104 Arvon Road; PO Box 165; Arvon, VA 23004; <http://www.savecenter.org>.
- h. Curtis, Allen J., Nicholas G. Tinling, Henry T. Abstein, Selection and Performance of Vibration Tests, Shock and Vibration Information Center, SVM-8 1971.
- i. Structural Alloys Handbook, Mechanical Properties Data Center, Belfour-Stulen, Inc., Traverse City, MI, 1977 edition.
- j. Robinson, John A. and Harry T. Cline, Methodology Investigation, Final Report, Cargo Configuration and Restraint in Military Ground Vehicles, TECOM Project No. 7-CO-R08-API-002; APG Report No. APG-MT-5319, November 1979.
- k. Baily, Richard D. and Spectral Dynamics Research Corporation, Methodology Investigation, Final Report, Determination of the Effective Mass of Cargo Beds, TECOM Project No. 7-CO-RD9-API-001, APG Report APG-MT-5572, December 1981.
- l. Handbook for Dynamic Data Acquisition and Analysis, IEST-RD-DTE012.2; Institute of Environmental Sciences and Technology, Arlington Place One, 2340 S. Arlington Heights Road, Suite 100, Arlington Heights, IL 60005-4516; <http://www.iest.org>.
- m. NATO Allied Environmental Conditions and Test Publication (AECTP) 240, Mechanical Environmental Testing, July 2009
- n. Connon, William, To 'b' or Not to 'b' - What was the question?, IEST ESTECH Proceedings May 2009, Institute of Environmental Sciences and Technology, Arlington Place One, 2340 S. Arlington Heights Road, Suite 100, Arlington Heights, IL 60005-4516; <http://www.iest.org>.
- o. ETBX Strain-Life Fatigue Analysis Module, 5 November 2008.
- p. Defence Standard (Def Stan) 00-35, Environmental Handbook for Defence Materiel, Issue 4, 28 March 2018.
- q. TOP 01-2-603, Rotorcraft Laboratory Vibration Schedules, 12 June 2017; DTIC AD No. AD1035102.
- r. Test Operations Procedure (TOP) 01-1-011B, Vehicle Test Facilities at Aberdeen Test Center Yuma Test Center, 12 December 2017; DTIC AD No. AD1043599.

MIL-STD-810H
METHOD 514.8, ANNEX F, APPENDIX F

(This page is intentionally blank.)

MIL-STD-810H
METHOD 515.8**METHOD 515.8**
ACOUSTIC NOISE**CONTENTS**

<u>Paragraph</u>	<u>Page</u>
1. SCOPE	1
1.1 PURPOSE	1
1.2 APPLICATION	1
1.3 LIMITATIONS.....	1
2. TAILORING GUIDANCE	1
2.1 SELECTING THE ACOUSTIC NOISE METHOD.....	1
2.1.1 EFFECTS OF THE ACOUSTIC NOISE ENVIRONMENT.....	1
2.1.2 SEQUENCE AMONG OTHER METHODS.....	2
2.2 SELECTING PROCEDURES	2
2.2.1 PROCEDURE SELECTION CONSIDERATIONS	2
2.2.2 DIFFERENCE AMONG PROCEDURES.....	2
2.3 DETERMINE TEST LEVELS AND CONDITIONS	3
2.3.1 GENERAL	3
2.3.2 USE OF MEASURED AND RELATED DATA.....	3
2.3.3 TYPES OF ACOUSTIC EXCITATION	3
2.3.3.1 DIFFUSE FIELD.....	3
2.3.3.2 GRAZING INCIDENCE ACOUSTIC NOISE.....	4
2.3.3.3 CAVITY RESONANCE.....	4
2.3.3.4 ADDITIONAL TECHNICAL GUIDANCE	4
2.4 TEST ITEM CONFIGURATION	4
3. INFORMATION REQUIRED.....	4
3.1 PRETEST.....	5
3.2 DURING TEST.....	5
3.3 POST-TEST	5
4. TEST PROCESS	5
4.1 TEST FACILITY	5
4.2 CONTROLS	6
4.2.1 CONTROL OPTIONS	6
4.2.1.1 SINGLE POINT NOISE CONTROL	6
4.2.1.2 MULTIPLE POINT NOISE CONTROL.....	6
4.2.1.3 VIBRATION RESPONSE CONTROL	6
4.2.2 CONTROL METHODS	6
4.2.3 OVERALL ACCURACY OF CONTROL	6
4.2.4 CALIBRATION AND TOLERANCE.....	6
4.3 TEST INTERRUPTION	7
4.3.1 INTERRUPTION DUE TO LABORATORY EQUIPMENT MALFUNCTION.....	7
4.3.2 INTERRUPTION DUE TO TEST ITEM OPERATION FAILURE	7
4.4 TEST SETUP.....	7
4.5 TEST EXECUTION	7
4.5.1 PREPARATION FOR TEST.....	7

MIL-STD-810H
METHOD 515.8

CONTENTS - Continued

<u>Paragraph</u>	<u>Page</u>
4.5.1.1 PRELIMINARY STEPS	7
4.5.1.2 PRETEST STANDARD AMBIENT CHECKOUT	7
4.5.2 INSTALLATION OF THE TEST ITEM	7
4.5.2.1 DIFFUSE FIELD	7
4.5.2.2 GRAZING INCIDENCE ACOUSTIC NOISE	8
4.5.2.3 CAVITY RESONANCE ACOUSTIC NOISE	8
4.5.3 PROCEDURE I - DIFFUSE FIELD ACOUSTIC NOISE TESTING	8
4.5.3.1 PROCEDURE Ia - UNIFORM INTENSITY ACOUSTIC NOISE TESTING	8
4.5.3.2 PROCEDURE Ib - DIRECT FIELD ACOUSTIC NOISE TESTING	9
4.5.4 PROCEDURE II - GRAZING INCIDENCE ACOUSTIC NOISE TESTING	9
4.5.5 PROCEDURE III - CAVITY RESONANCE ACOUSTIC NOISE TESTING	10
5. ANALYSIS OF RESULTS	10
6. REFERENCE/RELATED DOCUMENTS	10
6.1 REFERENCED DOCUMENTS	10
6.2 RELATED DOCUMENTS	10

TABLE

TABLE 515.8-I. TEST TOLERANCES	6
--------------------------------------	---

**METHOD 515.8 ANNEX A
GUIDANCE FOR INITIAL TEST SEVERITY**

1. BROADBAND RANDOM AND INCIDENCE NOISE TESTING	A-1
1.1 OVERALL SOUND PRESSURE LEVEL (OASPL)	A-1
1.2 TEST SPECTRUM	A-2
1.3 SIMULATION OF AERODYNAMIC TURBULENCE	A-3
2. CAVITY RESONANCE TESTING	A-3
3. EXTERNAL STORES TESTING	A-4
3.1 TEST SPECTRUM	A-4
3.2 TEST PARAMETERS	A-5

ANNEX A FIGURES

FIGURE 515.8A-1. APPLIED TEST SPECTRUM	A-2
FIGURE 515.8A-2. TYPICAL STORE PROFILE	A-4
FIGURE 515.8A-3. ONE-THIRD OCTAVE BAND SPECTRUM FOR ASSEMBLED EXTERNALLY CARRIED AIRCRAFT STORES	A-4

MIL-STD-810H
METHOD 515.8

CONTENTS - Continued

<u>Paragraph</u>	<u>Page</u>
ANNEX A TABLES	
TABLE 515.8A-I. OVERALL SOUND PRESSURE LEVELS AND DURATIONS	A-1
TABLE 515.8A-II. ONE-THIRD OCTAVE BAND LEVELS FOR FIGURE 515.8A-1	A-2
TABLE 515.8A-III. CAVITY RESONANCE TEST CONDITIONS (SEE PARAGRAPH 6.1, REFERENCE A).....	A-3
TABLE 515.8A-IV. SUGGESTED ACOUSTIC TEST LEVELS FOR ASSEMBLED EXTERNALLY CARRIED AIRCRAFT STORES	A-5
METHOD 515.8 ANNEX B ADDITIONAL TECHNICAL GUIDANCE	
1. REVERBERATION CHAMBERS.....	B-1
2. PROGRESSIVE WAVE TUBES.....	B-1
3. ACOUSTIC NOISE CHARACTERISTICS.....	B-1
4. CONTROL STRATEGIES	B-1
5. DEFINITIONS	B-2
5.1 SOUND PRESSURE LEVEL	B-2
5.2 THIRD OCTAVE FILTERS	B-2
6. DIRECT FIELD ACOUSTIC TEST CHARACTERISTICS	B-2

MIL-STD-810H
METHOD 515.8

(This page is intentionally blank.)

MIL-STD-810H
METHOD 515.8**METHOD 515.8**
ACOUSTIC NOISE

NOTE: Tailoring is essential. Select methods, procedures, and parameter levels based on the tailoring process described in Part One, paragraph 4.2.2, and Annex C. Apply the general guidelines for laboratory test methods described in Part One, paragraph 5 of this Standard.

1. SCOPE.**1.1 Purpose.**

The acoustic noise test is performed to determine the adequacy of materiel to resist the specified acoustic environment without unacceptable degradation of its functional performance and/or structural integrity.

1.2 Application.

This test is applicable to systems, sub-systems, and units, hereafter called materiel, that must function and/or survive in a severe acoustic noise environment. This test is also applicable for materiel located where acoustic noise excitation is used in combination with, or in preference to mechanical vibration excitation for the simulation of aerodynamic turbulence (Method 523.4).

1.3 Limitations.

Technical limitations restrict production and control of laboratory acoustic environments. Therefore, laboratory acoustic fields can be significantly different from many of the real fluctuating pressure loadings classed as "acoustic". Consider these limitations when choosing a test type and test facility, as well as in interpreting test results. For example, diffuse field acoustic noise (see paragraph 2.3.3.1) better represents acoustics in internal cavities where local reflection and re-radiation from vibrating structures predominate. For external skins exposed to aerodynamic turbulence or jet noise, grazing incidence acoustic noise (see paragraph 2.3.3.2) more closely represents flow/acoustic wave propagation along skin surfaces.

2. TAILORING GUIDANCE.**2.1 Selecting the Acoustic Noise Method.**

After examining the requirements documents and applying the tailoring process in Part One of this Standard to determine where acoustic noise may be encountered in the life cycle of the materiel, use the following to confirm the need for this Method and to place it in sequence with other methods.

2.1.1 Effects of the Acoustic Noise Method.

The acoustic noise environment is produced by any mechanical or electromechanical device capable of causing large airborne pressure fluctuations. In general, these pressure fluctuations are of an entirely random nature over a large amplitude range (5000 Pa to 87000 Pa) (0.73 psi to 12.6 psi), and over a broad frequency band extending from 10 Hz to 10000 Hz. On occasion there may exist very high amplitude discrete frequency pressure fluctuations referred to as 'tones'. When pressure fluctuations impact materiel, generally, a transfer of energy takes place between the energy (in the form of fluctuating pressure) in the surrounding air to the strain energy in materiel. This transfer of energy will result in vibration of the materiel, in which case the vibrating materiel may re-radiate pressure energy, absorb energy in materiel damping, or transfer energy to components or cavities interior to the materiel. Because of the large amplitude and broad frequency range of the fluctuating pressure, measurement of materiel response is important. The following list is not intended to be all-inclusive, but it provides examples of problems that could occur when materiel is exposed to an acoustic noise environment.

- a. Wire chafing.
- b. Component acoustic and vibratory fatigue.
- c. Component connecting wire fracture.

MIL-STD-810H
METHOD 515.8

- d. Cracking of printed circuit boards.
- e. Failure of wave guide components.
- f. Intermittent operation of electrical contacts.
- g. Cracking of small panel areas and structural elements.
- h. Optical misalignment.
- i. Loosening of small particles that may become lodged in circuits and mechanisms.
- j. Excessive electrical noise.

2.1.2 Sequence Among Other Methods.

- a. General. Use the anticipated life cycle sequence of events as a general sequence guide (see Part One, paragraph 5.5).
- b. Unique to this Method. Like vibration, the effects of acoustically induced stresses may affect materiel performance under other environmental conditions, such as temperature, humidity, pressure, electromagnetic, etc. When it is required to evaluate the effects of acoustic noise together with other environments, and when a combined test is impractical, expose a single test item to all relevant environmental conditions in turn. Consider an order of application of the tests that is compatible with the Life Cycle Environmental Profile (LCEP) and sequence guidance in the individual methods.

2.2 Selecting Procedures.

This Method includes three acoustic noise test procedures. Determine which of the following procedure(s) to be used.

- a. Procedure I (Diffuse Field) Ia – Uniform Intensity Acoustic Noise, Ib - Direct Field Acoustic Noise.
- b. Procedure II (Grazing Incidence Acoustic Noise)
- c. Procedure III (Cavity Resonance Acoustic Noise).

2.2.1 Procedure Selection Considerations.

The choice of test procedure is governed by the in-service acoustic environments and test purpose. Identify these environments from consideration of the Life Cycle Environmental Profile (LCEP) as described in Part One, Annex A, Task 402. When selecting procedures, consider:

- a. The operational purpose of the materiel. From the requirements documents, determine the functions to be performed by the materiel in an acoustic noise environment, the total lifetime exposure to acoustic noise, and any limiting conditions.
- b. The natural exposure circumstances.
- c. The test data required to determine if the operational purpose (function and life) of the materiel has been met.
- d. The procedure sequence within the acoustic noise method. If more than one of the enclosed procedures is to be applied to the same test item, it is generally more appropriate to conduct the less damaging procedure first.

2.2.2 Difference Among Procedures.

While all procedures involve acoustic noise, they differ on the basis of how the acoustic noise fluctuating pressure is generated and transferred to the materiel.

a. Procedure I - Diffuse Field

Ia - Uniform Intensity Acoustic Noise.

Procedure Ia has a uniform intensity shaped spectrum of acoustic noise that impacts all the exposed materiel surfaces.

Ib - Direct Field Acoustic Noise (DFAN).

Procedure Ib uses normal incident plane waves in a shaped spectrum of acoustic noise to impact directly on all exposed test article surfaces without external boundary reflections. Depending on

MIL-STD-810H
METHOD 515.8

the geometry of the test article this could produce magnitude variations on surfaces due to phasing differences between the plane waves. In the case of large surface area, low mass density test articles the phasing difference may excite primary structure modes in a different way than the diffuse reverberant field. This fundamental difference and its impact on the structure must be weighed against the advantages of the DFAN method. See annex B, paragraph 6 for more detailed information.

- b. Procedure II - Grazing Incidence Acoustic Noise. Procedure II includes a high intensity, rapidly fluctuating acoustic noise with a shaped spectrum that impacts the materiel surfaces in a particular direction - generally along the long dimension of the materiel.
- c. Procedure III - Cavity Resonance Acoustic Noise. In Procedure III, the intensity and, to a great extent, the frequency content of the acoustic noise spectrum is governed by the relationship between the geometrical configuration of the cavity and the materiel within the cavity.

2.3 Determine Test Levels and Conditions.

2.3.1 General.

Having selected this Method and relevant procedures (based on the materiel's requirements and the tailoring process), it is necessary to complete the tailoring process by selecting specific parameter levels and special test conditions/techniques for these procedures based on the requirements documents, Life Cycle Environmental Profile, and information provided with this procedure. From these sources of information, determine test excitation parameters and the functions to be performed by the materiel in acoustic noise environments or following exposure to these environments.

2.3.2 Use of Measured and Related Data.

Wherever possible, use specifically measured data to develop the test excitation parameters and obtain a better simulation of the actual environment. Obtain data at the materiel location, preferably on the specific platform or, alternatively, on the same platform type. In general, the data will be a function of the intended form of simulation. In some cases, only microphone sound pressure levels will be useful, and in other cases materiel acceleration response measurements will be useful.

2.3.3 Types of Acoustic Excitation.

2.3.3.1 Diffuse Field

2.3.3.1.1 Uniform Intensity Acoustic Noise.

A diffuse field is generated in a reverberation chamber. Normally wide band random excitation is provided and the spectrum is shaped. This test is applicable to materiel or structures that have to function or survive in an acoustic noise field such as that produced by aerospace vehicles, power plants and other sources of high intensity acoustic noise. Since this test provides an efficient means of inducing vibration above 100 Hz, the test may also be used to complement a mechanical vibration test, using acoustic energy to induce mechanical responses in internally mounted materiel. In this role, the test is applicable to items such as installed materiel in airborne stores carried externally on high performance aircraft. However, since the excitation mechanism induced by a diffuse field is different from that induced by aerodynamic turbulence, when used in this role, this test is not necessarily suitable for testing the structural integrity of thin shell structures interfacing directly with the acoustic noise. A practical guideline is that acoustic tests are not required if materiel is exposed to broadband random noise at a sound pressure level less than 130 dB (reference 20 μ Pascal) overall, and if its exposure in every one Hertz band is less than 100 dB (reference 20 μ Pascal). A diffuse field acoustic test is usually defined by the following parameters:

- a. Spectrum levels.
- b. Frequency range.
- c. Overall sound pressure level.
- d. Duration of the test.

MIL-STD-810H
METHOD 515.8**2.3.3.1.2 Direct Field Acoustic Noise.**

A direct field is generated by audio drivers arranged to encircle the test article. Two different control schemes can be used to perform a direct field test. One method, known as single input, single output or SISO, uses a single drive signal to all acoustic drivers with multiple control microphones averaged to produce the control measurement. This method will produce a set of correlated plane waves that may combine to produce large magnitude variations creating local fluctuations on the test article surface. Magnitude variations as much as ± 12 dB can be experienced. This variation may not be acceptable for some applications. The second method, known as Multiple Input, Multiple Output or MIMO, uses multiple independent drive signals to control multiple independent microphone locations. This method produces a more uncorrelated field that is much more uniform than the SISO field. Magnitude variations in the range of ± 3 dB are typical when using MIMO control. All other characteristics of diffuse field testing described in 2.3.3.1.1 also apply to the direct field method.

2.3.3.2 Grazing Incidence Acoustic Noise.

Grazing incidence acoustic noise is generated in a duct, popularly known as a progressive wave tube. Normally, wide band random noise with a shaped spectrum is directed along the duct. This test is applicable to assembled systems that have to operate or survive in a service environment of pressure fluctuations over the surface, such as exist in aerodynamic turbulence. These conditions are particularly relevant to aircraft panels, where aerodynamic turbulence will exist on one side only, and to externally carried stores subjected to aerodynamic turbulence excitation over their total external exposed surface. In the case of a panel, the test item will be mounted in the wall of the duct so that grazing incidence excitation is applied to one side only. An aircraft carried store such as a missile will be mounted co-axially within the duct such that the excitation is applied over the whole of the external surface. A grazing incidence acoustic noise test is usually defined by the following parameters:

- a. Spectrum levels.
- b. Frequency range.
- c. Overall sound pressure level.
- d. Duration of the test.

2.3.3.3 Cavity Resonance.

A resonance condition is generated when a cavity, such as that represented by an open weapons bay on an aircraft, is excited by the airflow over it. This causes oscillation of the air within the cavity at frequencies dependent upon the cavity dimensions and the aerodynamic flow conditions. In turn, this can induce vibration of the structure and of components in and near the cavity. The resonance condition can be simulated by the application of a sinusoidal acoustic source, tuned to the correct frequency of the open cavity. The resonance condition will occur when the control microphone response reaches a maximum in a sound field held at a constant sound pressure level over the frequency range. A cavity resonance test is defined by the following parameters:

- a. Noise frequency.
- b. Overall sound pressure level within the cavity.
- c. Duration of the test.

2.3.3.4 Additional Technical Guidance.

Additional Guidance related to the various types of Acoustic Excitation is given in Annex B

2.4 Test Item Configuration.

(See Part One, paragraph 5.8.) Where relevant, function the test item, and measure and record performance data during each test phase and/or each acoustic level applied.

3. INFORMATION REQUIRED.

The following information is necessary to properly conduct the acoustic test.

MIL-STD-810H
METHOD 515.8**3.1 Pretest.**

- a. General. See the information listed in Part One, paragraphs 5.7, 5.8, 5.9, 5.11 and 5.12; and Part One, Annex A, Task 405 of this Standard.
- b. Specific to this Method.
 - (1) Establish test levels and durations using projected Life Cycle Environmental Profiles, available data or data acquired directly from an environmental data-gathering program. When these data are not available, use the guidance on developing initial test severities in Annex A. Consider these overall sound pressure levels (OASPL) (Annex A, Table 515.8A-I) as initial values until measured data are obtained. The test selected may not necessarily be an adequate simulation of the complete environment and consequently a supporting assessment may be necessary to complement the test results.
 - (2) If the test item is required to operate during the test; the operating checks required are pretest, during the test, and post test. For the pre- and post test checks, specify whether they are performed with the test item installed in the test facility. Define the details required to perform the test, including the method of attachment or suspension of the test item, the surfaces to be exposed, effect of gravity and any consequent precautions. Identify the control and monitor points, or a procedure to select these points. Define test interruption, test completion and failure criteria.
- c. Tailoring. Necessary variations in the basic test procedures to accommodate LCEP requirements and/or facility limitations.

3.2 During Test.

- a. General. See the information listed in Part One, paragraph 5.10, and in Part One, Annex A, Tasks 405 and 406.
- b. Specific to this Method.
 - (1) Collect outputs of microphones, test control averages, test item operating parameters and any other relevant transducers at appropriate test times.
 - (2) Collect log/records of materiel operating parameters.
 - (3) Give particular attention to interactions of the input excitation (diffuse, directional or tonal).
 - (4) Record transient behavior in the input representing a test anomaly.

3.3 Post-Test.

The following post test data shall be included in the test report.

- a. General. See the information listed in Part One, paragraph 5.13; and in Part One, Annex A, Task 406 of this Standard.
- b. Specific to this Method.
 - (1) Identify any indication of failure under specified failure criteria. Account for tolerance excesses when testing large materiel, the number of simultaneous test items in Procedure I, and any other environmental conditions at which testing was carried out, if other than standard laboratory conditions.
 - (2) Ensure detailed data analysis for verification of the input to the test item, i.e., the acoustic field and the response monitoring of the test item, are in accordance with the test plan.
 - (3) Any deviations from the test plan.

4. TEST PROCESS.**4.1 Test Facility.**

Ensure the apparatus used to perform the acoustic test has sufficient capacity to adequately reproduce the input requirements. Diffuse acoustic field apparatus that produce uniform acoustic fields above 165 dB are rare. For high

MIL-STD-810H
METHOD 515.8

level acoustic input (above 165 dB), consider testing using grazing incidence acoustic noise. For measured data that indicates tonal input, consider a facility that can be configured to produce a cavity resonance condition.

4.2 Controls.

The control strategy depends upon the type of test and the size of the materiel.

4.2.1 Control Options.

4.2.1.1 Single Point Noise Control.

Define the single point, providing an optimum control position in the chamber or progressive wave tube.

4.2.1.2 Multiple Point Noise Control.

Select the control points to define a controlled volume within the reverberation chamber. Base control upon the average of the sound spectrum levels at each microphone. Where the range of measurements at the monitoring positions does not exceed 5 dB (OASPL) a simple arithmetic average of the sound spectrum levels (in dB) may be used. For a range of 5 dB or greater, use an average of the non-logarithmic sound spectrum levels (i.e., μPa or microbar), then convert to dB.

4.2.1.3 Vibration Response Control.

Where it is necessary to achieve a given vibration acceleration response on the test item, adjust the acoustic test spectrum to achieve the required response that may be monitored at either a single point or as the average from multiple monitoring points. Refer to Method 514.8 for further guidance.

4.2.2 Control Methods.

Control can be by either open or closed loop. Open loop control is adequate for progressive wave tubes and for small chambers having a single noise source. Closed loop control is more effective for large chambers having multiple noise sources that cover different bands in the test frequency range.

4.2.3 Overall Accuracy of Control.

Ensure the uncertainty of measurement of the total measurement system, including statistical errors, does not exceed one-third of the specified tolerance for the overall sound pressure level.

4.2.4 Calibration and Tolerance.

Test tolerances are given in Table 515.8-I. Ensure the test tolerance and calibration procedures for test control are generally consistent with the guidance provided in Part One, paragraph 5.3.2.

Table 515.8-I. Test tolerances.

PARAMETER	TOLERANCE
Overall sound pressure level averaged over all control microphones, ref specified overall sound pressure level	+3 dB -1 dB
Overall sound pressure level at each control microphone, ref specified overall sound pressure level	+4 dB -2 dB
Averaged test spectrum from all control microphones at levels above -15 dB in 1/3 octave bands, ref specified 1/3 octave band sound pressure levels.	±4 dB
Averaged test spectrum from all control microphones at levels below -15 dB and above -25 dB in 1/3 octave bands, ref specified 1/3 octave band sound pressure levels.	±6 dB
Averaged test spectrum from all control microphones at levels -25 dB and below in 1/3 octave bands, ref specified 1/3 octave band sound pressure levels.	±10 dB
Duration	±5 % or ±1 min whichever is less

MIL-STD-810H
METHOD 515.8**4.3 Test Interruption.**

Test interruptions can result from two or more situations, one being from failure or malfunction of test laboratory equipment. The second type of test interruption results from failure or malfunction of the test item itself during required or optional performance checks.

4.3.1 Interruption Due To Laboratory Equipment Malfunction.

- a. General. See Part One, paragraph 5.11 of this Standard.
- b. Specific to this Method. Interruption of an acoustic noise test is unlikely to generate any adverse effects. Normally, continue the test from the point of interruption.

4.3.2 Interruption Due To Test Item Operation Failure.

Failure of the test item(s) to function as required during mandatory or optional performance checks during testing presents a situation with several possible options.

- a. The preferable option is to replace the test item with a “new” one and restart from Step 1.
- b. A second option is to replace / repair the failed or non-functioning component or assembly with one that functions as intended, and restart the entire test from Step 1.

NOTE: When evaluating failure interruptions, consider prior testing on the same test item and any consequences of such.

4.4 Test Setup.

- a. General. See Part One, paragraph 5.8.
- b. Unique to this Method. Tests will normally be carried out with the test item mounted in the correct attitude, unless it is shown that the performance of the test item is not affected by gravity.

4.5 Test Execution.

The following steps, alone or in combination, provide the basis for collecting necessary information concerning the test item in an acoustic environment.

4.5.1 Preparation for Test.**4.5.1.1 Preliminary Steps.**

Before starting the test, determine the test details (e.g., procedure variations, test item configuration, cycles, durations, parameter levels for storage/operation, etc.) from the test plan. (See paragraph 3.1 above.)

4.5.1.2 Pretest Standard Ambient Checkout.

- a. Unless otherwise specified, allow the test item to stabilize at standard ambient conditions.
- b. Perform a physical inspection and operational checks before and after testing. Define the requirements for these checks in the test plan. If these checks are required during the test sequence, specify the time intervals at which they are required.
- c. Ensure that all test environment monitoring instrumentation and test item function monitoring instrumentation is consistent with the calibration and test tolerance procedures, and are generally consistent with the guidance provided in Part One, paragraphs 5.3.2 and 5.2, respectively.

4.5.2 Installation of the Test item.**4.5.2.1 Diffuse Field****4.5.2.1.1 Uniform Intensity Acoustic Noise.**

Suspend the test item (or as otherwise mounted) in a reverberation chamber on an elastic system in such a manner that all appropriate external surfaces are exposed to the acoustic field and no surface is parallel to a chamber surface.

MIL-STD-810H
METHOD 515.8

Ensure the resonance frequency of the mounting system with the specimen is less than 25 Hz or 1/4 of the minimum test frequency, whichever is less. If cables, pipes etc., are required to be connected to the test item during the test, arrange them to provide similar restraint and mass as in service. Locate a microphone in proximity to each major different face of the test item at a distance of 0.5 meter (1.64 ft) from the face, or midway between the center of the face and the chamber wall, whichever is smaller. Average the outputs from these microphones to provide a single control signal. When the chamber is provided with a single noise injection point, place one microphone between the test item and the chamber wall furthest from the noise source. The orientation of the microphones in such a facility is not critical, but do not set the microphone axes normal to any flat surface. Calibrate the microphones for random incidence.

4.5.2.1.2 Direct Field Acoustic Noise (DFAN).

The test item should be surrounded by a circular array of acoustic drivers to a height of at least 1 meter (3.28 ft) above the test article. The arrangement should avoid symmetry to reduce the potential for adverse coupling of plane waves. The test article can be mounted on a platform or suspended. Multiple microphones, eight to sixteen, should be used for control with either the SISO or MIMO methods (see annex B, paragraph 6). The microphones should be placed randomly around the test article. The distance from the surface of the drivers to the control microphones should be no less than 1m (3.28 ft). The distance from the surface of the test article to the control microphones should also be no less than 1m (3.28 ft) unless the pre-test characterization determines there are no structure induced pressure effects on the microphone. The height of the control microphones should be centered at mid-height of the test item and randomly varied up and down by about one-half of the test item height. The orientation of the free-field microphones in a DFAN test arrangement is not critical. However, reflections from the test article can be minimized with the microphone oriented toward the sound source with a 0 degree incidence (see Paragraph 6, reference c, figure 3.7). Most modern day, quality measurement, free-field microphones are factory adjusted to compensate for incident angle. This phenomenon is most pronounced at high frequencies, above 10kHz for a 1/4" microphone, and is inversely proportional to microphone diaphragm diameter.

4.5.2.2 Grazing Incidence Acoustic Noise.

Mount test items such as panels in the wall of the duct such that the required test surfaces are exposed to the acoustic excitation. Ensure this surface is flush with the inner surface of the duct to prevent the introduction of cavity resonance or local turbulence effects. Suspend test items (such as aircraft external stores) centrally within the duct, on an elastic support. Orient the test item such that the appropriate surfaces are subjected to progressive acoustic waves. For example, orient an aircraft external store parallel to the duct centerline so that the acoustic waves sweep the length of the store. Ensure the rigid body modes of the test item are lower than 25 Hz or 1/4 of the lowest test frequency, whichever is less. Ensure that no spurious acoustic or vibratory inputs are introduced by the test support system or by any ancillary structure. Mount the microphone(s) for control and monitoring of test conditions in the duct wall opposite the test panel. Select other positions within the duct assuming the microphone is positioned so that it responds to only grazing incidence waves, and that the necessary corrections are applied to the measured level. Calibrate the microphones for grazing incidence.

4.5.2.3 Cavity Resonance Acoustic Noise.

Suspend the test item (or as otherwise mounted) in a reverberation chamber such that only that part of the cavity to be tested is exposed to the direct application of acoustic energy. Protect all other surfaces so that their level of acoustic excitation is reduced by 20 dB. Do not use protective coverings that provide any additional vibration damping to the structure. Do not locate the microphone for control of the test within the cavity to be tested.

4.5.3 Procedure I – Diffuse Field Acoustic Noise Testing**4.5.3.1 Procedure Ia - Uniform Intensity Acoustic Noise Testing.**

- Step 1 Install the test item in the reverberation chamber in accordance with paragraph 4.5.2.1.1
- Step 2 Select microphone positions for control, monitoring, and control strategy in accordance with paragraph 4.5.2.1.1.
- Step 3 When using open loop control, remove the test item and confirm the specified overall sound pressure level and spectrum can be achieved in an empty chamber, then replace the test item in the chamber.
- Step 4 Precondition the test item in accordance with paragraph 4.5.1.2.

MIL-STD-810H
METHOD 515.8

- Step 5 Conduct initial checks in accordance with paragraph 4.5.1.2.
- Step 6 Apply the test spectrum for the specified time. If required, carry out inspections and operational checks in accordance with paragraph 4.5.1.2. If the test item fails to operate as intended, follow the guidance in paragraph 4.3.2 for test item failure.
- Step 7 Record the test acoustic field at each microphone, any average used in test control, and other pertinent transducer outputs. Make the recordings at the beginning, midpoint, and end of each test run. Where test runs are longer than one hour, record every one-half hour.
- Step 8 Carry out the final inspection and operational checks, and see paragraph 5 for analysis of results.
- Step 9 Remove the test item from the chamber.
- Step 10 In all cases, record the information required.

4.5.3.2 Procedure Ib - Direct Field Acoustic Noise Testing.

- Step 1 Build a test setup using a test item simulator in accordance with paragraph 4.5.2.1.2
- Step 2 Select microphone positions for control, monitoring, and control strategy in accordance with paragraph 4.5.2.1.2.
- Step 3 Perform a pre-test using the simulator to confirm the specified overall sound pressure level and spectrum can be achieved. Also verify any special control features to be used such as; abort tolerances, response limits, field shaping and emergency shut-down procedures. Monitor the resulting field for uniformity, coherence and structural response, if available. Then replace the simulator with the actual test item in the speaker circle.
- Step 4 Precondition the test item in accordance with paragraph 4.5.1.2.
- Step 5 Conduct initial checks in accordance with paragraph 4.5.1.2.
- Step 6 Apply the test spectrum for the specified time. Use multiple runs if the allowable audio system full level ON (duty cycle as discussed in Annex B, paragraph 6) time is less than the total test time. If required, carry out inspections and operational checks in accordance with paragraph 4.5.1.2. If the test item fails to operate as intended, follow the guidance in paragraph 4.3.2 for test item failure.
- Step 7 Record the test acoustic field at each microphone, any average used in test control, and other pertinent transducer outputs. Make the recordings at the beginning, midpoint, and end of each test run. Where test runs are longer than one hour, record every one-half hour.
- Step 8 Carry out the final inspection and operational checks, and see paragraph 5 for analysis of results.
- Step 9 Remove the test item from the circle.
- Step 10 In all cases, record the information required.

4.5.4 Procedure II - Grazing Incidence Acoustic Noise Testing.

- Step 1 Install the test item in accordance with paragraph 4.5.2.2.
- Step 2 Select microphone positions for control, monitoring, and control strategy in accordance with paragraph 4.5.2.2.
- Step 3 Precondition the test item in accordance with paragraph 4.5.1.2.
- Step 4 Conduct initial checks in accordance with paragraph 4.5.1.2.
- Step 5 Apply the test spectrum for the specified time. If required, carry out inspections and operational checks in accordance with paragraph 4.5.1.2. If the test item fails to operate as intended, follow the guidance in paragraph 4.3.2 for test item failure.
- Step 6 Record the test acoustic field at each microphone, any average used in test control, and other pertinent transducer outputs. Make recordings at the beginning, end and midpoint of each test run. Where test runs are longer than one hour, record every one-half hour.

MIL-STD-810H
METHOD 515.8

Step 7 Carry out the final inspection and operational checks, and see paragraph 5 for analysis of results.

Step 8 Remove the test item from the duct.

Step 9 In all cases, record the information required.

4.5.5 Procedure III - Cavity Resonance Acoustic Noise Testing.

Step 1 Install the test item into the chamber in accordance with paragraph 4.5.2.3.

Step 2 Locate the control microphone in accordance with paragraph 4.5.2.3.

Step 3 Precondition the test item in accordance with paragraph 4.5.1.2.

Step 4 Conduct initial checks in accordance with paragraph 4.5.1.2.

Step 5 Apply the sinusoidal acoustic excitation at the required frequencies (see Annex A, Table 515.8A-II). Adjust the test parameters to the specified levels and apply for the specified time. If required, carry out inspections and operational checks in accordance with paragraph 4.5.1.2. If the test item fails to operate as intended, follow the guidance in paragraph 4.3.2 for test item failure.

Step 6 Record the test acoustic field at each microphone, any average used in test control, and other pertinent transducer outputs. Make recordings at the beginning, midpoint, and end of each test run. Where test runs are longer than one hour, record every one-half hour.

Step 7 Perform the final physical inspection and operational checks, and see paragraph 5 for analysis of results.

Step 8 Remove the test item from the chamber.

Step 9 In all cases, record the information required.

5. ANALYSIS OF RESULTS.

Refer to Part One, paragraphs 5.14 and 5.17; and Part One, Annex A, Task 406.

6. REFERENCE/RELATED DOCUMENTS.**6.1 Referenced Documents.**

- a. AFFDL-TR-76-91; Volume II: "A Review of Methods for Estimation of Aero-acoustic Loads on Flight Vehicle Surfaces". February 1977.
- b. NATO Allied Environmental Engineering and Test Publication (AECTP) 400, Mechanical Environmental Testing, Method 401, Vibration.
- c. Beranek, Leo L., "Noise and Vibration Control" Revised Edition, 1988, Institute of Noise Control Engineering, ISBN: 0-9622072-0-9.
- d. Larkin, Paul A. and Smallwood, David O. "Control of an Acoustical Speaker System in a Reverberant Chamber", *Journal of the IEST*, V. 47, No. 2, 2004.
- e. Larkin, Paul A. and Hayes, Dann "Status of Direct Field Acoustic Testing", 27th Aerospace Testing Seminar, October 16-18, 2012.
- f. Maahs, Gordon, "Direct Field Acoustic Test (DFAT) Development and Flight Testing of Radiation Belt Storm Probe (RBSP) Satellites", 27th Space Simulation Conference, November 5-8, 2012.

6.2 Related Documents.

- a. NATO STANAG 4370, Environmental Testing.
- b. NATO Allied Environmental Engineering and Test Publication (AECTP) 400, Mechanical Environmental Testing, Method 402, Acoustic Noise.
- c. ISO 266, Acoustics – Preferred Frequencies, International Organization for Standardization, 27 March 1997; <http://www.iso.org>.

MIL-STD-810H
METHOD 515.8

- d. Egbert, Herbert W. "The History and Rationale of MIL-STD-810 (Edition 2)", January 2010; Institute of Environmental Sciences and Technology, Arlington Place One, 2340 S. Arlington Heights Road, Suite 100, Arlington Heights, IL 60005-4516.
- e. IEST RP-DTE040.1, High-Intensity Acoustics Testing, Institute of Environmental Sciences and Technology, Arlington Place One, 2340 S. Arlington Heights Road, Suite 100, Arlington Heights, IL 60005-4516; January 2003; <http://www.iest.org>.
- f. NASA-STD-7001, Payload Vibroacoustic Test Criteria, National Aeronautics and Space Agency, 21 June 1996, <http://standards.nasa.gov>.

(Copies of Department of Defense Specifications, Standards, and Handbooks, and International Standardization Agreements are available online at <https://assist.dla.mil>.)

Requests for other defense-related technical publications may be directed to the Defense Technical Information Center (DTIC), ATTN: DTIC-BR, Suite 0944, 8725 John J. Kingman Road, Fort Belvoir VA 22060-6218, 1-800-225-3842 (Assistance--selection 3, option 2), <http://www.dtic.mil/dtic/>; and the National Technical Information Service (NTIS), Springfield VA 22161, 1-800-553-NTIS (6847), <http://www.ntis.gov/>.

MIL-STD-810H
METHOD 515.8

(This page is intentionally blank.)

MIL-STD-810H
METHOD 515.8 ANNEX A

METHOD 515.8, ANNEX A
GUIDANCE FOR INITIAL TEST SEVERITY

1. BROADBAND RANDOM AND INCIDENCE NOISE TESTING.

1.1 Overall Sound Pressure Level (OASPL).

From the known area of operation for the materiel, the test overall sound pressure level and duration may be obtained from Table 515.8A-I.

Table 515.8A-I. Overall sound pressure levels and durations.

TYPICAL APPLICATION	TEST LEVEL (OASPL) dB	DURATION (Min)
Transport aircraft at locations not close to jet exhausts	130	30
Transport aircraft, in internal materiel bays close to jet exhausts	140	30
High performance aircraft at location not close to jet exhausts	145	
High performance aircraft in internal materiel bays close to jet exhausts	150	30
Air-to-air missile on medium performance aircraft (i.e., dynamic pressure (q)<57456 Pa (1200 psf)).	150	30
Air-to-ground missile on medium performance aircraft (i.e., q<57456 Pa (1200 psf)).	150	15
Ground materiel in enclosed engine run-up areas	135	30
High performance aircraft in internal materiel bays close to reheat exhaust and gun muzzles or in nose cones	160	30
Airborne rocket most locations (excluding booster or engine bays)	160	8
Air-to-air missile on high performance aircraft (i.e., q<86184 Pa (1800 psf)).	165	30
Air-to-ground missile on high performance aircraft (i.e., q<86184 Pa (1800 psf)).	165	15
Airborne rocket booster or engine bays	165	8

MIL-STD-810H
METHOD 515.8 ANNEX A

1.2 Test Spectrum.

The applied test spectrum associated with these levels is shown on Figure 515.8A-1 with breakpoints defined in Table 515.8A-II. Achieve the test spectrum while maintaining the test parameters within the tolerances given in Table 515.8-I.

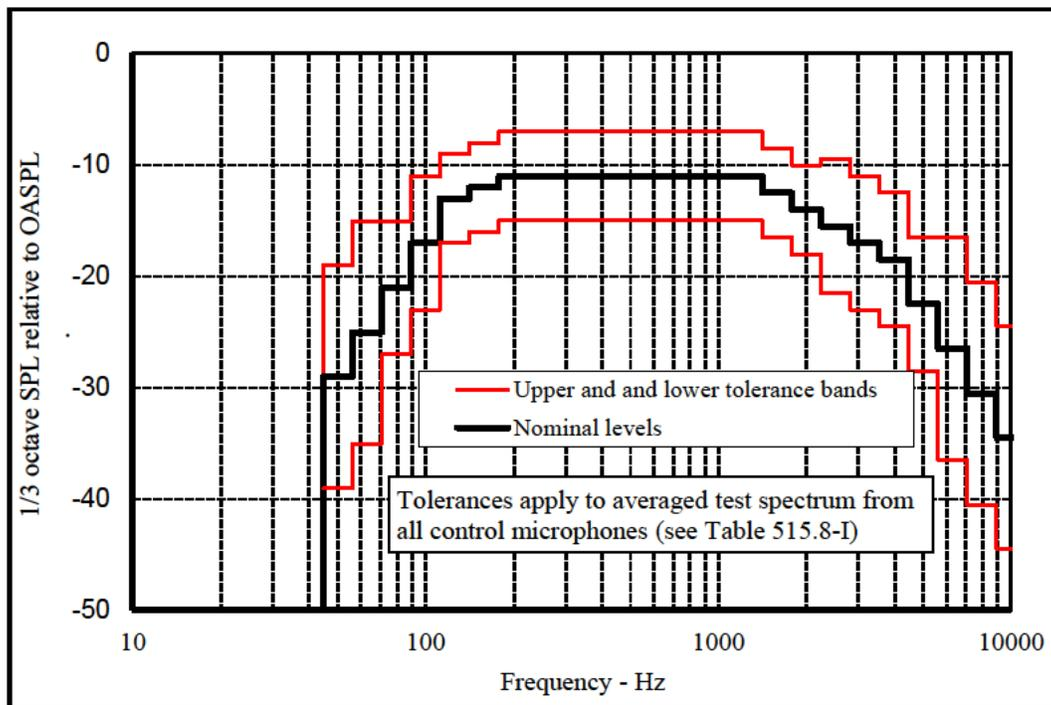


Figure 515.8A-1. Applied test spectrum.

Table 515.8A-II. One-third octave band levels for Figure 515.8A-1.

1/3 octave center frequency Hz	Upper tolerance limit dB	Nominal level dB	Lower tolerance limit dB	1/3 octave center frequency Hz	Upper tolerance limit dB	Nominal level dB	Lower tolerance limit dB
50	-19	-29	-39	800	-7	-11	-15
63	-15	-25	-35	1000	-7	-11	-15
80	-15	-21	-27	1250	-7	-11	-15
100	-11	-17	-23	1600	-8.5	-12.5	-16.5
125	-9	-13	-17	2000	-10	-14	-18
160	-8	-12	-16	2500	-9.5	-15.5	-21.5
200	-7	-11	-15	3150	-11	-17	-23
250	-7	-11	-15	4000	-12.5	-18.5	-24.5
315	-7	-11	-15	5000	-16.5	-22.5	-28.5
400	-7	-11	-15	6300	-16.5	-26.5	-36.5
500	-7	-11	-15	8000	-20.5	-30.5	-40.5
630	-7	-11	-15	10000	-24.5	-34.5	-44.5

MIL-STD-810H
METHOD 515.8 ANNEX A

1.3 Simulation of Aerodynamic Turbulence.

Where a broadband noise test is required for the simulation of aerodynamic turbulence, derive the test levels and durations in conjunction with those for the complementary mechanical test.

2. CAVITY RESONANCE TESTING

For cavity resonance testing, the sound pressure level B_0 , frequencies f_N and duration T will be as calculated or defined in Table 515.8A-III.

Table 515.8A-III. Cavity resonance test conditions. (See paragraph 6.1, reference a.)

<u>Test level</u>
$B_0 = 20 \log(q) + 76.4 \text{ dB} \quad (\text{ref } 20 \mu\text{Pa})$
$f_N = \left(\frac{U_\infty}{L} \right) \left(\frac{N - 0.25}{M \sqrt{1 + M^2 \frac{\gamma - 1}{2}}} + 0.57 \right) \text{ Hz} \quad \text{Equation (1)}$
<p><u>For Equation (1):</u></p> <ul style="list-style-type: none"> - For cavities that have a length/depth $(L/D) \geq 2$ - For applications where $0.4 \leq M \leq 1.5$
$f_N = \left(\frac{2N - 1}{4} \right) \left(\frac{c}{h} \right) \quad \text{Equation (2)}$
<p><u>For Equation (2)</u></p> <ul style="list-style-type: none"> - For cavities that have a length/depth $(L/D) < 2$
<p>Where c = speed of sound h = cavity depth f_N = Resonance frequency for the N^{th} mode (where $N=1, 2, 3, \dots$) up to 500 Hz (where $f_1 > 500$ Hz use only this mode) N = Mode number L = Length/radius of opening exposed to air stream (m). M = Mach number U_∞ = Free-stream velocity γ = Ratio of specific heats of gas (1.4 for air)</p>
<p>Test duration: $T=1$ hour per resonance frequency</p>

MIL-STD-810H
METHOD 515.8 ANNEX A**3. EXTERNAL STORES TESTING.****3.1 Test Spectrum.**

A typical store profile is shown on Figure 515.8A-2. The applied test spectrum is shown on Figure 515.8A-3.

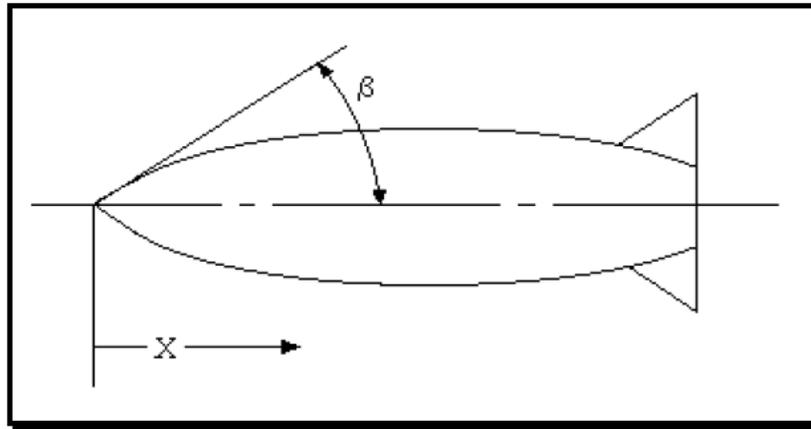


Figure 515.8A-2. Typical store profile.

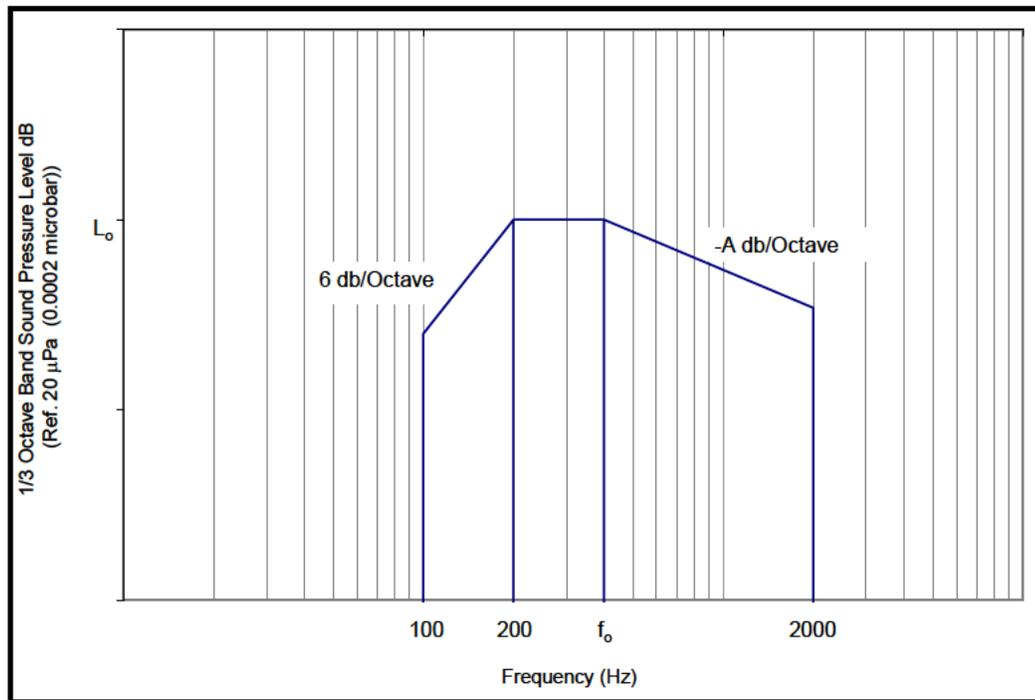


Figure 515.8A-3. One-third octave band spectrum for assembled externally carried aircraft stores.

MIL-STD-810H
METHOD 515.8 ANNEX A

3.2 Test Parameters.

For acoustic testing of external stores, the associated levels and definitions are shown in Table 515.8A-IV.

Table 515.8A-IV. Suggested acoustic test levels for assembled externally carried aircraft stores.

A = 6 dB/Octave when $f_0 > 400$ Hz		
A = 2 dB/Octave when $f_0 \leq 400$ Hz		
Functional Test		
$L_0 = 20 \log (q_1) + 11 \log (X) + 7 \log (1 - \cos \beta) + G + H$	(dB)	(see Notes 1, 5, 6, 7.)
$f_0 = 600 \log (X/R) + C$		(see Notes 2, 3.)
Endurance Test		
$L_0 = 20 \log (q_2/q_1) + 2.5 \log (N/3T) + \text{functional level}$	(dB)	(see Notes 1, 5, 6, 7.)
$f_0 = 600 \log (X/R) + C$		(see Notes 2, 3.)
Definitions		
$q_1 = \text{captive flight dynamic pressure (lbs/ft}^2) \leq 1800$		
$q_2 = 1200 \text{ psf or maximum captive flight dynamic pressure (whichever is lower) (lbs/ft}^2)$		
$N = \text{maximum number of anticipated service missions (minimum } N = 3)$		
$R = \text{local radius of store in inches}$		(see Note 4.)
$X = \text{distance from nose of store along axis of store in inches}$		
$T = \text{test time in hours (minimum } T = 1 \text{ hour unless otherwise specified)}$		
$C = -200 \text{ for locations (1) within one (D) of the aft end of the store, or (2) aft of a flow reentry point.}$ (See Note 8); = 400 for all other locations		
$D = \text{maximum store diameter in inches}$		(see Note 4.)
$\beta = \text{local nose cone angle at } X \text{ equals } 1/\tan \beta = (R/X)$		(see figure 515.5A-2)
$G = 72 \text{ unless measured data shows otherwise}$		
$E = 96 \text{ unless measured data shows otherwise}$		
$F = 84 \text{ unless measured data shows otherwise}$		
$H = 0 \text{ for } 0.85 < M < 0.95;$ = -3 dB for all other values of M		
$M = \text{Mach number}$		

MIL-STD-810H
METHOD 515.8 ANNEX A

Table 515.8A-IV. Continued.

Representative parametric values to be used for captive flight when specific parameters are not available:

<i>Store Type</i>	<i>N Endurance</i>	<i>Local Nose Cone Angle Degrees</i>	<i>q max</i>	<i>f₀ Nose Section</i>	<i>f₀ Middle Section</i>	<i>f₀ Aft Section</i>
<i>Air-to-Air Missile</i>	<i>100</i>	<i>69</i>	<i>1600</i>	<i>500</i>	<i>1000</i>	<i>500</i>
<i>Air-to-Ground Missile</i>	<i>3</i>	<i>12</i>	<i>1600</i>	<i>800</i>	<i>630</i>	<i>630</i>
<i>Instrument Pod</i>	<i>500</i>	<i>69</i>	<i>1800</i>	<i>500</i>	<i>1000</i>	<i>500</i>
<i>Reusable Dispenser</i>	<i>50</i>	<i>11</i>	<i>1200</i>	<i>630</i>	<i>1000</i>	<i>400</i>
<i>Demolition Bomb</i>	<i>3</i>	<i>24</i>	<i>1200</i>	<i>500</i>	<i>1000</i>	<i>630</i>
<i>Flat Nose Store</i>	<i>3</i>	<i>90</i>	<i>1200</i>	<i>400</i>	<i>630</i>	<i>315</i>

NOTES:

- Raise computed L_0 level by 3 dB for a store carried in a TER cluster rack; by 5 dB for an MER cluster rack.
- If calculated f_0 is above 2000 Hz, use upper frequency limit of 2000 Hz. If calculated f_0 is below 200 Hz, use 200 Hz.
- Round off f_0 upward to a one-third octave center band frequency.
- For stores that do not have circular cross-sections, use the radius in the formulas that is the radius of the circle that circumscribes the cross-section of the store.
- For locations on flat nose stores ($80^\circ \leq \beta \leq 90^\circ$) where $X < 100$:
 Functional test: $L_0 = 20 \log (q_1) - 6 \log (X) + E + H$
 Endurance test: $L_0 = 20 \log (q_2) - 6 \log (X) + E + 2.5 \log (N/3T) + H$
- For long cylindrical section, $> 2D$, use for locations more than one D aftward into the cylindrical section:
 Functional test: $L_0 = 20 \log (q_1) + F + H$
 Endurance test: $L_0 = 20 \log (q_2) + F + 2.5 \log (N/3T) + H$
- For changing radius section either aft of a long cylindrical section or when $X > 100$ on a flat nose store, redefine X so that $X = 1$ at the beginning of this section.
 Functional test: $L_0 = 20 \log (q_1) + 11 \log (X) + F + H$
 Endurance test: $L_0 = 20 \log (q_2) + 11 \log (X) + F + 2.5 \log (N/3T) + H$
- A flow reentry point is the furthest upstream (forward) point of a store cross section change which results in a flow component toward the store centerline as opposed to flow away from or parallel to the store centerline.

MIL-STD-810H
METHOD 515.8 ANNEX B

METHOD 515.8, ANNEX B
ADDITIONAL TECHNICAL GUIDANCE

1. REVERBERATION CHAMBERS.

A reverberation chamber is basically a cell with hard, acoustically reflective walls. When noise is generated in this room, the multiple reflections within the main volume of the room cause a uniform diffuse noise field to be set up. The uniformity of this field is disturbed by three main effects.

- a. At low frequencies, standing modes are set up between parallel walls. The frequency below which these modes become significant is related to the chamber dimensions. Small chambers, below about 100 cubic meters in volume, are usually constructed so that no wall surfaces are parallel to each other in order to minimize this effect.
- b. Reflections from the walls produce higher levels at the surface. The uniform noise field therefore only applies at positions within the central volume of the chamber; do not position test items within about 0.5 m (1.6 ft) of the walls.
- c. The size of the test item can distort the noise field if the item is large relative to the volume of the chamber. It is normally recommended that the volume of the test item not exceed 10 percent of the chamber volume.

Noise is normally generated with an air modulator and is injected into the chamber via a coupling horn. Provision is made in the chamber design to exhaust the air from the modulator through an acoustic attenuator in order to prevent the direct transmission of high intensity noise to areas outside the test chamber.

2. PROGRESSIVE WAVE TUBES.

A parallel sided duct usually forms the working section of such a progressive noise facility. This may be circular or rectangular in section to suit the test requirements. For testing panels, a rectangular section may be more suitable while an aircraft carried store may be more conveniently tested in a duct of circular section. Noise is generated by an air modulator coupled into one end of the working section by a suitable horn. From the opposite end of the plain duct another horn couples the noise into an absorbing termination. Maximum absorption over the operating frequency range is required here in order to minimize standing wave effects in the duct. Noise then progresses along the duct and is applied with grazing incidence over the surface of the test item. The test item itself may be mounted within the duct in which case the grazing incidence wave will be applied over the whole of its external surface. Alternatively, the test item may be mounted in the wall of the duct when the noise will be applied to only that surface within the duct, e.g., on one side of a panel. The method used will depend upon the test item and its in-service application.

3. ACOUSTIC NOISE CHARACTERISTICS.

Radiated high intensity noise is subjected to distortion due to adiabatic heating. Thus, due to heating of the high pressure peaks and cooling of the rarefaction troughs, the local speed of propagation of these pressures is modified. This causes the peaks to travel faster and the troughs to travel slower than the local speed of propagation such that, at a distance from the source, a sinusoidal wave becomes triangular with a leading shock front. This waveform is rich in harmonics and therefore the energy content is extended into a higher frequency range. It can be seen from this that it is not possible to produce a pure sinusoidal tone at high noise intensities. The same effect takes place with high intensity random noise that is commonly produced by modulating an airflow with a valve driven by a dynamic actuator. Due to velocity and/or acceleration restraints on the actuator, it is not possible to modulate the airflow at frequencies greater than about 1 kHz. Acoustic energy above this frequency, extending to 20 kHz or more, therefore results from a combination of cold air jet noise and harmonic distortion from this lower frequency modulation.

4. CONTROL STRATEGIES.

Microphones are normally used to monitor and control the test condition. When testing stores and missiles, it is recommended that not less than three microphones be used to control the test. Some test items may be more effectively monitored on their vibration response; in which case, follow the monitoring requirements of Method 514.8, as appropriate. Use a monitoring system capable of measuring random noise with a peak to rms ratio of up to 3.0. Correct pressure calibrated microphones used in reverberation chambers for random incidence noise, while correcting those used in progressive wave tubes for free field grazing incidence noise, and ensure both have a linear pressure

MIL-STD-810H
METHOD 515.8 ANNEX B

response. Provide for averaging the outputs of the microphones to provide the spatial average of the noise for control purposes.

5. DEFINITIONS.

5.1 Sound Pressure Level.

The sound pressure level (L_p) is the logarithmic ratio of the sound pressures:

$$L_p = 10 \log \frac{I}{I_0} = 20 \log \frac{P}{P_0}$$

Expressed as:

where I_0 = reference intensity = 10^{-12} Wm^{-2}

and P_0 = reference pressure = 20×10^{-6} Pa

5.2 Third Octave Filters.

The center frequency, f_0 , of a third octave filter is:

$$f_0 = (f_1 \times f_2)^{1/2}$$

where f_1 = lower -3 dB frequency

and f_2 = upper -3 dB frequency

The relationships between the upper and lower -3 dB frequencies are:

$$\frac{(f_2 - f_1)}{f_0} = 0.23$$

$$f_2 = 2^{1/3} f_1$$

Standard third octave bands are defined in International Specification ISO 266.

6. DIRECT FIELD ACOUSTIC NOISE CHARACTERISTICS.

Closed-loop, digital control is preferred for all direct field testing. Since the drivers used are capable of responding over the entire test bandwidth (usually 25 to 10kHz) and beyond, narrow-band drive signals are often used to control the test. Narrow-band control allows all features of modern, random vibration control systems such as; control of local resonances, response limiting, peak limits/aborts based on spectral lines out, and rms limits/aborts to be used for acoustic testing. See paragraph 6.1, references d and e, for more information about narrow-band control.

Single Input, Single Output (SISO) control will produce a well correlated sound field since the same drive signal is delivered to all audio devices. However, sound pressure level (SPL) variations due to wave interference patterns in the SISO field can be as large as ± 12 dB from the average SPL due to constructive and destructive wave combinations. In addition, multiple microphone averaging can exacerbate the problem by allowing large variations at the control points to result in an apparently well controlled composite when compared to the reference. Typical performance in the SISO environment is ± 1 dB variation between the reference and the composite control average with ± 5 dB of control microphone to control microphone variation and ± 12 dB or more between monitor microphone locations.

The recent application of MIMO (Multiple Input,-Multiple Output) acoustic control to the DFAN process has created a much improved methodology over the earlier practice of using a SISO approach. The MIMO process is based on multiple, independent inputs, multiple references and results in multiple independent drive outputs. Using MIMO control the user can input magnitude, phase and coherence specifications with tolerance bands on each. The system will use those constraints and the independent drives to produce a complying environment at each control point. In effect, this method controls the response of each control microphone to meet its individual requirements based on the input it receives from each independent drive signal. The result can be an incoherent field with minimum variation between control microphones. This represents a huge improvement in field uniformity (spatial variation) as well as providing a sound field with much lower coherence. Typical test tolerances for a MIMO controlled test are ± 1 dB on

MIL-STD-810H
METHOD 515.8 ANNEX B

the composite control average and ± 3 dB at each control microphone relative to the reference spectrum for overall levels in the 125 to 145dB range. See paragraph 6.1, reference e for more information about SISO and MIMO control.

As stated in paragraph 2.2.2.a.Ib, DFAN testing does not create an environment that is identical to a reverberant chamber. However, DFAN testing can produce a very similar structural response. Paragraph 6.1, reference f gives a detailed comparison of the results from a DFAN test with those from reverberant testing for a typical spacecraft structure subjected to a typical launch vehicle environment. Similar configurations can be expected to produce similar results. Structures and/or environments that vary greatly from those documented may require similar study and evaluation before implementing the DFAN approach.

Lastly, a restriction on run time for test levels above 144dB is usually imposed due to heat build-up in the driving coils of the acoustic drivers. Currently technology limits runs at 140 to 144dB to about one minute and runs above 144dB to about 30 seconds. If run times longer than these are required, it is recommended that the total test time be broken into multiple segments of 30 seconds each until the total run time is accumulated.

MIL-STD-810H
METHOD 515.8 ANNEX B

(This page is intentionally blank.)

MIL-STD-810H
METHOD 516.8**METHOD 516.8****SHOCK****CONTENTS**

<u>Paragraph</u>	<u>Page</u>
1. SCOPE	1
1.1 PURPOSE	1
1.2 APPLICATION	1
1.3 LIMITATIONS	1
2. TAILORING GUIDANCE	2
2.1 SELECTING THE SHOCK METHOD	2
2.1.1 EFFECTS OF SHOCK	2
2.1.2 SEQUENCE AMONG OTHER METHODS	2
2.2 SELECTING A PROCEDURE	3
2.2.1 PROCEDURE SELECTION CONSIDERATIONS	3
2.2.2 DIFFERENCE AMONG PROCEDURES	4
2.3 DETERMINE TEST LEVELS AND CONDITIONS	5
2.3.1 GENERAL CONSIDERATIONS - TERMINOLOGY AND PROCESSING PROCEDURES WITH ILLUSTRATION.....	5
2.3.1.1 THE SHOCK MODEL	5
2.3.1.2 LABORATORY SHOCK TEST OPTIONS	7
2.3.2 TEST CONDITIONS	9
2.3.2.1 SRS BASED ON MEASURED DATA	10
2.3.2.2 SRS IN THE ABSENCE OF MEASURED DATA.....	10
2.3.2.3 CLASSICAL SHOCK PULSE	12
2.3.3 TEST AXES AND NUMBER OF SHOCK EVENTS – GENERAL CONSIDERATIONS	16
2.3.3.1 SPECIAL CONSIDERATIONS FOR COMPLEX TRANSIENTS	16
2.4 TEST ITEM CONFIGURATION	16
3. INFORMATION REQUIRED.....	16
3.1 PRETEST	16
3.2 DURING TEST	17
3.3 POST-TEST	17
4. TEST PROCESS	17
4.1 TEST FACILITY	17
4.2 CONTROLS	18
4.2.1 CALIBRATION.....	18
4.2.2 TOLERANCES.....	18
4.2.2.1 CLASSICAL PULSES AND COMPLEX TRANSIENT PULSE-TIME DOMAIN	18
4.2.2.2 COMPLEX TRANSIENT PULSES-SRS	18
4.3 TEST INTERRUPTION	19
4.3.1 INTERRUPTION DUE TO LABORATORY EQUIPMENT MALFUNCTION.....	19
4.3.2 INTERRUPTION DUE TO TEST ITEM OPERATION FAILURE	19
4.4 INSTRUMENTATION	20
4.5 DATA ANALYSIS	21
4.6 TEST EXECUTION	22
4.6.1 PREPARATION FOR TEST.....	22
4.6.1.1 PRELIMINARY GUIDELINES	22
4.6.1.2 PRETEST CHECKOUT	22
4.6.1.3 PROCEDURES' OVERVIEW	22

MIL-STD-810H
METHOD 516.8

CONTENTS – Continued

<u>Paragraph</u>	<u>Page</u>
4.6.2	FUNCTIONAL SHOCK (PROCEDURE I) 22
4.6.2.1	TEST CONTROLS - FUNCTIONAL SHOCK (PROCEDURE I) 24
4.6.2.2	TEST TOLERANCES - FUNCTIONAL SHOCK (PROCEDURE I) 24
4.6.2.3	TEST PROCEDURE I - FUNCTIONAL SHOCK (PROCEDURE I) 24
4.6.3	TRANSPORTATION SHOCK (PROCEDURE II)..... 25
4.6.3.1	TEST CONTROLS - TRANSPORTATION SHOCK (PROCEDURE II) 26
4.6.3.2	TEST TOLERANCES - TRANSPORTATION SHOCK (PROCEDURE II)..... 26
4.6.3.3	TEST PROCEDURE - TRANSPORTATION SHOCK (PROCEDURE II)..... 26
4.6.4	FRAGILITY (PROCEDURE III) 26
4.6.4.1	TEST CONTROLS - FRAGILITY (PROCEDURE III)..... 29
4.6.4.2	TEST TOLERANCES - FRAGILITY (PROCEDURE III) 30
4.6.4.3	TEST PROCEDURE - FRAGILITY (PROCEDURE III)..... 30
4.6.5	TRANSIT DROP (PROCEDURE IV) 31
4.6.5.1	TEST CONTROLS - TRANSIT DROP (PROCEDURE IV) 32
4.6.5.2	TEST TOLERANCES - TRANSIT DROP (PROCEDURE IV) 37
4.6.5.3	TEST PROCEDURE - TRANSIT DROP (PROCEDURE IV) 37
4.6.6	CRASH HAZARD SHOCK (PROCEDURE V)..... 38
4.6.6.1	TEST CONTROLS - CRASH HAZARD SHOCK (PROCEDURE V) 38
4.6.6.2	TEST TOLERANCES - CRASH HAZARD SHOCK (PROCEDURE V)..... 38
4.6.6.3	TEST PROCEDURE - CRASH HAZARD SHOCK (PROCEDURE V) 38
4.6.7	BENCH HANDLING (PROCEDURE VI)..... 39
4.6.7.1	TEST CONTROLS - BENCH HANDLING (PROCEDURE VI) 39
4.6.7.2	TEST TOLERANCES - BENCH HANDLING (PROCEDURE VI)..... 39
4.6.7.3	TEST PROCEDURE - BENCH HANDLING (PROCEDURE VI) 39
4.6.8	PENDULUM IMPACT (PROCEDURE VII) 39
4.6.8.1	TEST CONTROLS - PENDULUM IMPACT (PROCEDURE VII) 39
4.6.8.2	TEST TOLERANCES - PENDULUM IMPACT (PROCEDURE VII)..... 40
4.6.8.3	TEST PROCEDURE - PENDULUM IMPACT (PROCEDURE VII) 40
4.6.9	CATAPULT LAUNCH/ARRESTED LANDING (PROCEDURE VIII) 41
4.6.9.1	TEST CONTROLS - CATAPULT LAUNCH/ARRESTED LANDING (PROCEDURE VIII) 41
4.6.9.2	TEST TOLERANCES - CATAPULT LAUNCH/ARRESTED LANDING (PROCEDURE VIII) 43
4.6.9.3	TEST PROCEDURE - CATAPULT LAUNCH/ARRESTED LANDING (PROCEDURE VIII) 43
5.	ANALYSIS OF RESULTS 44
6.	REFERENCE/RELATED DOCUMENTS 44
6.1	REFERENCED DOCUMENTS..... 44
6.2	RELATED DOCUMENTS..... 45

FIGURES

FIGURE 516.8-1.	BASE INPUT SDOF SYSTEM MODEL FOR SHOCK CONSIDERATIONS..... 6
FIGURE 516.8-2.	TEST SRS FOR USE IF MEASURED DATA ARE NOT AVAILABLE (FOR PROCEDURE I - FUNCTIONAL SHOCK, AND PROCEDURE V - CRASH HAZARD SHOCK TEST) 11
FIGURE 516.8-3.	TERMINAL PEAK SAWTOOTH SHOCK PULSE CONFIGURATION AND ITS TOLERANCE LIMITS..... 13
FIGURE 516.8-4.	TRAPEZOIDAL SHOCK PULSE CONFIGURATION AND TOLERANCE LIMITS..... 13
FIGURE 516.8-5.	HALF-SINE SHOCK PULSE CONFIGURATION AND TOLERANCE LIMITS 14
FIGURE 516.8-6.	ILLUSTRATION OF TEMPORAL AND SPECTRAL DISTORTION ASSOCIATED WITH A COMPENSATED CLASSICAL TERMINAL PEAK SAWTOOTH 15
FIGURE 516.8-7.	TRAPEZOIDAL PULSE: VELOCITY CHANGE VERSUS DROP HEIGHT 28
FIGURE 516.8-8.	STANDARD DROP ORIENTATIONS FOR RECTANGULAR AND CYLINDRICAL PACKAGES..... 36
FIGURE 516.8-9.	ILLUSTRATION OF EDGE DROP CONFIGURATION (CORNER DROP END VIEW IS ALSO ILLUSTRATED) 37

MIL-STD-810H
METHOD 516.8

CONTENTS - Continued

<u>Paragraph</u>	<u>Page</u>
FIGURE 516.8-10. PENDULUM IMPACT TEST	40
FIGURE 516.8-11. SAMPLE MEASURED STORE THREE AXIS CATAPULT LAUNCH COMPONENT RESPONSE ACCELERATION TIME HISTORIES.....	42
FIGURE 516.8-12. SAMPLE MEASURED STORE THREE AXIS ARRESTED LANDING COMPONENT RESPONSE ACCELERATION TIME HISTORIES.....	43

TABLES

TABLE 516.8-I. SHOCK TEST PROCEDURES AND CONFIGURATIONS SUMMARY	3
TABLE 516.8-II. LABORATORY TEST OPTIONS.....	8
TABLE 516.8-III. TEST SHOCK RESPONSE SPECTRA FOR USE IF MEASURED DATA ARE NOT AVAILABLE	11
TABLE 516.8-IV. TERMINAL PEAK SAWTOOTH DEFAULT TEST PARAMETERS FOR PROCEDURE I - FUNCTIONAL TEST (REFER TO FIGURE 516.8-3)	23
TABLE 516.8-V. HSC STANDARDIZED REQUIREMENTS	23
TABLE 516.8-VI. HSC LIMITED APPLICATION REQUIREMENTS BY CRAFT SIZE	24
TABLE 516.8-VII. PROCEDURE II - TRANSPORTATION SHOCK TEST SEQUENCE.....	25
TABLE 516.8-VIII. FRAGILITY SHOCK TRAPEZOIDAL PULSE PARAMETERS (REFER TO FIGURE 516.8-4).....	28
TABLE 516.8-IX. LOGISTIC TRANSIT DROP TEST.....	33
TABLE 516.8-X. TACTICAL TRANSPORT DROP TEST	34
TABLE 516.8-XI. SEVERE TACTICAL TRANSPORT TROP TEST	35
TABLE 516.8-XII. FIVE STANDARD DROP TEST ORIENTATIONS	36
TABLE 516.8-XIII. TERMINAL PEAK SAWTOOTH DEFAULT TEST PARAMETERS FOR PROCEDURE V – CRASH HAZARD (REFER TO FIGURE 516.8-3)	38

METHOD 516.8 ANNEX A

MEASUREMENT SYSTEM CHARACTERIZATION AND BASIC PROCESSING

1. SINGLE SHOCK EVENT MEASUREMENT SYSTEM CHARACTERIZATION AND BASIC PROCESSING.....	A-1
1.1 MEASUREMENT SYSTEM AND SIGNAL CONDITIONING PARAMETERS.....	A-1
1.2 MEASUREMENT SHOCK IDENTIFICATION	A-3
1.3 EFFECTIVE SHOCK DURATION FOR NON-CLASSICAL SHOCKS	A-4
1.3.1 CALCULATION OF T_c	A-6
1.3.2 CALCULATION OF T_E	A-6
1.3.3 IMPLEMENTATION CONSIDERATIONS	A-7
1.4 SHOCK RESPONSE SPECTRUM	A-7
1.4.1 PROCESSING GUIDELINES	A-7
1.4.2 PROCESSING EXAMPLE	A-10
1.5 FREQUENCY DOMAIN IDENTIFICATION ENERGY SPECTRAL DENSITY (ESD).....	A-11
1.6 SINGLE EVENT / MULTIPLE CHANNEL MEASUREMENT PROCESSING GUIDELINES	A-11
1.7 MEASUREMENT PROBABILISTIC / STATISTICAL SUMMARY	A-11
1.8 OTHER PROCESSING.....	A-12

ANNEX A FIGURES

FIGURE 516.8A-1. a. FILTER ATTENUATION	A-1
FIGURE 516.8A-1. b. ILLUSTRATION OF SAMPLING RATES AND OUT OF BAND “FOLD OVER” FREQUENCIES FOR DATA ACQUISITION SYSTEMS	A-3
FIGURE 516.8A-2. EXAMPLE ACCELERATION TIME HISTORY	A-4
FIGURE 516.8A-3. EXAMPLE SIMPLE SHOCK TIME HISTORY WITH SEGMENT IDENTIFICATION	A-5
FIGURE 516.8A-4. MAXIMAX PSEUDO-VELOCITY SRS ESTIMATES FOR SHOCK AND NOISE FLOOR SEGMENTS	A-8

MIL-STD-810H
METHOD 516.8**CONTENTS - Continued**

<u>Paragraph</u>	<u>Page</u>
FIGURE 516.8A-5. <i>SHOCK</i> MAXIMUM AND MINIMUM PSEUDO-VELOCITY SRS ESTIMATES	A-9
FIGURE 516.8A-6. <i>SHOCK</i> MAXIMUM AND MINIMUM ACCELERATION SRS ESTIMATES.....	A-10
FIGURE 516.8A-7. MAXIMAX ACCELERATION SRS ESTIMATES FOR SHOCK AND NOISE FLOOR SEGMENTS.....	A-11

METHOD 516.8 ANNEX B**GUIDELINES FOR ADDITIONAL SHOCK TIME HISTORY VALIDATION AND PROCESSING**

1. INTRODUCTION.....	B-1
2. COMPLEX SHOCKS.....	B-1
3. ADDITIONAL SIMPLE SHOCK PROCESSING AND VALIDATION	B-3
3.1 INTRODUCTION	B-3
3.2 INSTANTANEOUS ROOT-MEAN-SQUARE (RMS)	B-3
3.3 SHOCK VELOCITY/DISPLACEMENT VALIDATION CRITERIA	B-5
3.4 ESD ESTIMATE	B-6
4. SHOCK IDENTIFICATION AND ANOMALOUS MEASUREMENT BEHAVIOR	B-7

ANNEX B FIGURES

FIGURE 516.8B-1. SHOCK TIME HISTORY WITH SEGMENT IDENTIFICATION AND T_c AND T_e TIME INTERVALS ILLUSTRATED	B-2
FIGURE 516.8B-2. A COMPLEX SHOCK	B-2
FIGURE 516.8B-3. SHOCK TIME HISTORY INSTANTANEOUS ROOT-MEAN-SQUARE.....	B-4
FIGURE 516.8B-4. MEASUREMENT VELOCITY VIA INTEGRATION OF MEAN (DC) REMOVED ACCELERATION.....	B-5
FIGURE 516.8B-5. MEASUREMENT DISPLACEMENT VIA INTEGRATION OF VELOCITY AFTER MEAN (DC) REMOVAL ..	B-6
FIGURE 516.8B-6. SHOCK ESD ESTIMATE.....	B-7
FIGURE 516.8B-7. MEASUREMENT INPUT OVERDRIVING THE SIGNAL CONDITIONING WITH CLIPPING	B-8
FIGURE 516.8B-8. NOISY OR MISSING MEASUREMENT SIGNALS	B-8
FIGURE 516.8B-9. COMBINATION AMPLIFIER OVERDRIVING AND NOISE	B-9

METHOD 516.8 ANNEX C**STATISTICAL AND PROBABILISTIC CONSIDERATIONS FOR DEVELOPING LIMITS ON PREDICTED AND PROCESSED DATA ESTIMATES**

1. SCOPE	C-1
1.1 PURPOSE	C-1
1.2 APPLICATION	C-1
2. DEVELOPMENT.....	C-1
2.1 LIMIT ESTIMATE SET SELECTION	C-1
2.2 ESTIMATE PREPROCESSING CONSIDERATIONS	C-1
2.3 PARAMETRIC UPPER LIMIT STATISTICAL ESTIMATE ASSUMPTIONS.....	C-2
2.3.1 NTL - UPPER NORMAL ONE-SIDED TOLERANCE LIMIT	C-3
2.3.2 NPL - UPPER NORMAL PREDICTION LIMIT	C-5
2.4 NON-PARAMETRIC UPPER LIMIT STATISTICAL ESTIMATE PROCEDURES.....	C-5
2.4.1 ENVELOPE (ENV) - UPPER LIMIT	C-5
2.4.2 DISTRIBUTION FREE LIMIT (DFL) - UPPER DISTRIBUTION-FREE TOLERANCE LIMIT	C-5

MIL-STD-810H
METHOD 516.8

CONTENTS - Continued

<u>Paragraph</u>	<u>Page</u>
2.4.3	EMPIRICAL TOLERANCE LIMIT (ETL) - UPPER EMPIRICAL TOLERANCE LIMIT C-6
3.	EXAMPLE..... C-6
3.1	INPUT TEST DATA SET C-6
3.2	PARAMETRIC UPPER LIMITS..... C-7
3.3	NON-PARAMETRIC UPPER LIMITS C-8
3.4	OBSERVATIONS..... C-8
4.	RECOMMENDED PROCEDURES C-8
4.1	RECOMMENDED STATISTICAL PROCEDURES FOR UPPER LIMIT ESTIMATES C-8
4.2	UNCERTAINTY FACTORS C-8

ANNEX C FIGURES

FIGURE 516.8C-1.	INPUT TEST DATA SET..... C-7
FIGURE 516.8C-2.	PARAMETRIC AND NON-PARAMETRIC UPPER LIMITS..... C-7

ANNEX C TABLES

TABLE 516.8C-I.	NORMAL TOLERANCE FACTORS FOR UPPER TOLERANCE LIMIT..... C-4
TABLE 516.8C-II.	INPUT TEST DATA SET..... C-6

MIL-STD-810H
METHOD 516.8

(This page is intentionally blank.)

MIL-STD-810H
METHOD 516.8**METHOD 516.8****SHOCK**

NOTE: Tailoring is essential. Select methods, procedures, and parameter levels based on the tailoring process described in Part One, paragraph 4.2.2, and its Annex C. Apply the general guidelines for laboratory test methods described in Part One, paragraph 5 of this Standard.

Due to extensive revision to this method, no change bars have been provided.

1. SCOPE.**1.1 Purpose.**

Shock tests are performed to:

- a. Provide a degree of confidence that materiel can physically and functionally withstand the shocks encountered in handling, transportation, and service environments. This may include an assessment of the overall materiel system integrity for safety purposes in any one or all of the handling, transportation, and service environments.
- b. Determine the materiel's fragility level, in order that packaging, stowage, or mounting configurations may be designed to protect the materiel's physical and functional integrity.
- c. Test the strength of devices that attach materiel to platforms that may be involved in a crash situation and verify that the material itself does not create a hazard or that parts of the materiel are not ejected during a crash situation.

1.2 Application.

Use this Method to evaluate the physical and functional performance of materiel likely to be exposed to mechanically induced shocks in its lifetime. Such mechanical shock environments are generally limited to a frequency range not to exceed 10,000 Hz, and a duration of not more than 1.0 second. (In most cases of mechanical shock, the significant materiel response frequencies will not exceed 4,000 Hz, and the duration of materiel response will not exceed 0.1 second.)

1.3 Limitations.

This method does not include:

- a. The effects of shock experienced by materiel as a result of pyrotechnic device initiation. For this type of shock, see Method 517.3, Pyroshock.
- b. The effects experienced by materiel to very high level localized impact shocks, e.g., ballistic impacts. For this type of shock, see Method 522.2, Ballistic Shock.
- c. The high impact shock effects experienced by materiel aboard a ship due to wartime service. Consider performing shock tests for shipboard materiel in accordance with MIL-DTL-901 (paragraph 6.1, reference c).
- d. The effects experienced by fuse systems. Perform shock tests for safety and operation of fuses and fuse components in accordance with MIL-STD-331 (paragraph 6.1, reference d).
- e. The effects experienced by materiel that is subject to high pressure wave impact, e.g., pressure impact on a materiel surface as a result of firing of a gun. For this type of shock and subsequent materiel response, see Method 519.8, Gunfire Shock.
- f. The shock effects experienced by very large extended materiel, e.g., building pipe distribution systems, over which varied parts of the materiel may experience different and unrelated shock events. For this type of shock, devise specialized tests based on analytical models and/or experimental measurement data.

MIL-STD-810H
METHOD 516.8

- g. Special provisions for performing combined mechanical/climatic environment tests (e.g. shock tests at high or low temperatures). Guidelines found in the climatic test methods may be helpful in setting up and performing combined environment tests.
- h. Shocks integrated with transient vibration that are better replicated under Time Waveform Replication (TWR) methodology. See Method 525.2.
- i. Guidance on equivalence techniques for comparison of shock and vibration environments. Method 516, Annex C (Autospectral Density with Equivalent Test Shock Response Spectra) that was in previous revisions of MIL-STD-810 has been removed.
- j. Repetitive shocks associated with unrestrained cargo in ground transport vehicles that may be best replicated under loose cargo transportation methodology. See Method 514.8, Procedure II.

2. TAILORING GUIDANCE.

2.1 Selecting the Shock Method.

After examining requirements documents and applying the tailoring process in Part One of this Standard to determine where mechanical shock environments are foreseen in the life cycle of the materiel, use the following to confirm the need for this Method and to place it in sequence with other methods.

2.1.1 Effects of Shock.

Mechanical shock has the potential for producing adverse effects on the physical and functional integrity of all materiel. In general, the damage potential is a function of the amplitude, velocity, and the duration of the shock. Shocks with frequency content that correspond with materiel natural frequencies will magnify the adverse effects on the materiel's overall physical and functional integrity.

The materiel response to the mechanical shock environment will, in general, be highly oscillatory, of short duration, and have a substantial initial rise time with large positive and negative peak amplitudes of about the same order of magnitude (for high velocity impact shock, e.g., penetration shocks, there may be significantly less or no oscillatory behavior with substantial area under the acceleration response curve). The peak responses of materiel to mechanical shock will, in general, be enveloped by a decreasing form of exponential function in time. In general, mechanical shock applied to a complex multi-modal materiel system will cause the materiel to respond to (1) forced frequencies of a transient nature imposed on the materiel from the external excitation environment, and (2) the materiel's resonant natural frequencies either during or after application of the external excitation environment. Such response may cause:

- a. Materiel failure as a result of increased or decreased friction between parts, or general interference between parts.
- b. Changes in materiel dielectric strength, loss of insulation resistance, variations in magnetic and electrostatic field strength.
- c. Materiel electronic circuit card malfunction, electronic circuit card damage, and electronic connector failure. (On occasion, circuit card contaminants having the potential to cause short circuit may be dislodged under materiel response to shock.)
- d. Permanent mechanical deformation of the materiel as a result of overstress of materiel structural and non-structural members.
- e. Collapse of mechanical elements of the materiel as a result of the ultimate strength of the component being exceeded.
- f. Accelerated fatiguing of materials (low cycle fatigue).
- g. Potential piezoelectric activity of materials.
- h. Materiel failure as a result of cracks in fracturing crystals, ceramics, epoxies, or glass envelopes.

2.1.2 Sequence Among Other Methods.

- a. General. Use the anticipated life cycle sequence of events as a general sequence guide (see Part One, paragraph 5.5).

MIL-STD-810H
METHOD 516.8

- b. Unique to this Method. Sequencing among other methods will depend upon the type of testing, i.e., developmental, qualification, endurance, etc., and the general availability of test items for test. Normally, schedule shock tests early in the test sequence, but after any vibration tests with the following additional guidelines:
- (1) If the shock environment is deemed particularly severe, and the chances of materiel survival without structural or operational failure are small, the shock test should be first in the test sequence. This provides the opportunity to redesign the materiel to meet the shock requirement before testing to the more benign environments.
 - (2) If the shock environment is deemed severe, but the chance of the materiel survival without structural or functional failure is good, perform the shock test after vibration and thermal tests, allowing the stressing of the test item prior to shock testing to uncover combined mechanical and thermal failures.
 - (3) There are often advantages to applying shock tests before climatic tests, provided this sequence represents realistic service conditions. Test experience has shown that climate-sensitive defects often show up more clearly after the application of shock environments. However, internal or external thermal stresses may permanently weaken materiel resistance to vibration and shock that may go undetected if shock tests are applied before climatic tests.

2.2 Selecting a Procedure.

Table 516.8-I summarizes the eight test procedures covered in the Method with respect to the applicable configurations and operation states of the unit under test.

Table 516.8-I. Shock Test Procedures and Configurations Summary.

Procedure	Description	Packaged	Unpackaged	Operational	Non-Operational
I	Functional Shock		X	X	
II	Transportation Shock	X	X		X
III	Fragility		X		X
IV	Transit Drop	X	X		X
V	Crash Hazard Shock		X		
VI	Bench Handling		X		X
VII	Pendulum Impact	X			X
VIII	Catapult Launch/Arrested Landing		X	X	X

2.2.1 Procedure Selection Considerations.

Based on the test data requirements, determine which test procedure, combination of procedures, or sequence of procedures is applicable. In many cases, one or more of the procedures will apply. Consider all shock environments anticipated for the materiel during its life cycle, both in its logistic and operational modes. When selecting procedures, consider:

- a. The Operational Purpose of the Materiel. From requirement documents, determine the operations or functions to be performed by the materiel before, during and after the shock environment.
- b. The Natural Exposure Circumstances. Procedures I through VII are based on single shock events that result from momentum exchange between materiel or materiel support structures and another body. Procedure VIII (Catapult Launch/Arrested Landing) contains a sequence of two shocks separated by a comparatively short duration transient vibration for catapult launch, and a single shock for arrested landing.

MIL-STD-810H
METHOD 516.8

- c. Data Required. The test data required to document the test environment, and to verify the performance of the materiel before, during, and after test.

2.2.2 Difference Among Procedures.

- a. Procedure I - Functional Shock. Procedure I is intended to test materiel (including mechanical, electrical, hydraulic, and electronic) in its functional mode, and to assess the physical integrity, continuity, and functionality of the materiel to shock. In general, the materiel is required to function during and after the shock, and to survive without damage resulting from shocks representative of those that may be encountered during operational service.
- b. Procedure II - Transportation Shock. Procedure II is used to evaluate the response of an item or restraint system to transportation environments that create a repetitive shock load. The procedure uses a classical terminal peak sawtooth, either measured or a synthetic shock waveform, to represent the shock excitation portion of the transportation scenario. The shock can be a repetitive event of similar amplitude, or an irregular event that varies in amplitude and frequency bandwidth. Ground vehicle transportation is a common source for transportation shock. Procedure II is not equivalent or a substitute for Method 514.8, Secured Cargo Vibration or Category 5, Loose Cargo, or other Method 516.8 shock test procedures.
- c. Procedure III - Fragility. Procedure III is used early in the item development program to determine the materiel's fragility level, in order that packaging, stowage, or mounting configurations may be designed to protect the materiel's physical and functional integrity. This procedure is used to determine the critical shock conditions at which there is chance of structural and/or operational system degradation based upon a systematic increase in shock input magnitudes. To achieve the most realistic criteria, perform the procedure at environmental temperature extremes.
- d. Procedure IV - Transit Drop. Procedure IV is a physical drop test, and is intended for materiel either outside of, or within its transit or combination case, or as prepared for field use (carried to a combat situation by man, truck, rail, etc.). This procedure is used to determine if the materiel is capable of withstanding the shocks normally induced by loading and unloading when it is (1) outside of its transit or combination case, e.g., during routine maintenance, when being removed from a rack, being placed in its transit case, etc., or (2) inside its transit or combination case. Such shocks are accidental, but may impair the functioning of the materiel. This procedure is not intended for shocks encountered in a normal logistic environment as experienced by materiel inside bulk cargo shipping containers (ISO, CONEX, etc.). See Procedure II (Transportation Shock), and Procedure VII (Pendulum Impact).
- e. Procedure V - Crash Hazard Shock Test. Procedure V is for materiel mounted in air or ground vehicles that could break loose from its mounts, tiedowns, or containment configuration during a crash, and present a hazard to vehicle occupants and bystanders. This procedure is intended to verify the structural integrity of materiel mounts, tiedowns or containment configuration during simulated crash conditions. Use this test to verify the overall structural integrity of the materiel, i.e., parts of the materiel are not ejected during the shock. In some instances, the crash hazard can be evaluated by a static acceleration test (Method 513.8, Procedure III, or a transient shock (Method 516.8, Procedure V)). The requirement for one or both procedures must be evaluated based on the test item.
- f. Procedure VI - Bench Handling. Procedure VI is intended for materiel that may typically experience bench handling, bench maintenance, or packaging. It is used to determine the ability of the materiel to withstand representative levels of shock encountered during such environments. This procedure is appropriate for materiel out of its transit or combination case. Such shocks might occur during materiel repair. This procedure may include testing for materiel with protrusions that may be easily damaged without regard to gross shock on the total materiel. The nature of such testing must be performed on a case-by-case basis, noting the configuration of the materiel protrusions, and the case scenarios for damage during such activities as bench handling, maintenance, and packaging.
- g. Procedure VII - Pendulum Impact. Procedure VII is intended to test the ability of large shipping containers to resist horizontal impacts, and to determine the ability of the packaging and packing methods to provide protection to the contents when the container is impacted. This test is meant to simulate accidental handling impacts, and is used only on containers that are susceptible to accidental end impacts. The pendulum impact test is designed specifically for large and/or heavy shipping containers that are likely to be handled mechanically rather than manually.

MIL-STD-810H
METHOD 516.8

NOTE: The rail impact test, formerly Procedure VII, has been moved to Method 526.2.

- h. Procedure VIII - Catapult Launch/Arrested Landing. Procedure VIII is intended for materiel mounted in or on fixed-wing aircraft that is subject to catapult launches and arrested landings. For catapult launch, materiel may experience a combination of an initial shock followed by a low level transient vibration of some duration having frequency components in the vicinity of the mounting platform's lowest frequencies, and concluded by a final shock according to the catapult event sequence. For arrested landing, materiel may experience an initial shock followed by a low level transient vibration of some duration having frequency components in the vicinity of the mounting platform's lowest frequencies.

2.3 Determine Test Levels and Conditions.

Having selected this Method and relevant procedures (based on the materiel's requirements documents and the tailoring process), complete the tailoring process by identifying appropriate parameter levels, applicable test conditions, and test techniques for the selected procedures. Base these selections on the requirements documents, the Life Cycle Environmental Profile (LCEP), and information provided with the appropriate procedure. Many laboratory shock tests are conducted under standard ambient test conditions as discussed in Part One, paragraph 5. However, when the life cycle events being simulated occur in environmental conditions significantly different than standard ambient conditions, consider applying those environmental factors during shock testing. Individual climatic test procedures of this Standard include guidance for determining levels of other environmental loads. For temperature-conditioned environmental tests, (high temperature tests of explosive or energetic materials in particular), consider the materiel degradation due to extreme climatic exposure to ensure the total test program climatic exposure does not exceed the life of the materiel. (See Part One, paragraph 5.19.). Consider the following when selecting test levels:

2.3.1 General Considerations - Terminology and Processing Procedures with Illustration.

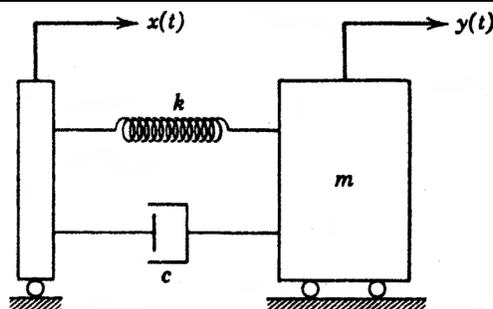
Much of the core terminology associated with shock testing is addressed in the following topics: (1) the *shock model*, (2) laboratory shock test options including tailoring when measured data are available, (3) single shock event characterization (in particular the crucial issue of shock duration with detailed additional information supplied in Annex A), (4) procedures for single shock event with multiple channel measurement processing for laboratory tests, (5) reference to statistical and probabilistic summary information for multiple shock events over possible multiple related measurements provided in Annex C, and (6) references to more advanced analysis techniques for characterizing a shock environment and its effects on materiel. Information in Annex C is crucial for processing measured data and test specification development.

2.3.1.1 The Shock Model.

This paragraph is essential to understanding the nature of the shock environment applied to materiel. The *shock model* represents materiel with a shock input defined by a comparatively short time and a moderately high-level impulse. The duration of the input is usually much less than the period of the fundamental frequency of the mounted materiel, and the amplitude of the input is above peaks of extreme materiel vibration response levels. Generally, the impulse input is distributed to the materiel surface or body directly or, more commonly, to the materiel through its mounts to a primary structure. It is difficult to directly measure such an impulse in time versus magnitude. When the impulse is applied to the materiel through its mounting points to a structure, a simple base-excited single-degree-of-freedom (SDOF) linear system can serve as a shock model for the materiel at a single resonant frequency of the materiel. Figure 516.8-1 displays such a system with the mass representing the materiel, and the combination spring/damper representing the path that supplies the impulse to the materiel. This model is used to define the Shock Response Spectra (SRS) considered throughout the subparagraphs of 2.3.1 and Annex A. Figure 516.8-1 displays the second order differential equations of motion that justify base input impulse specified as displacement/velocity. The solution can be in terms of absolute mass motion acceleration, or in terms of relative motion between the base and the mass. For an assumed base input acceleration measurement, the second-order differential equation of motion is "solved" by filtering the shock acceleration using a series of SDOF systems based upon a ramp-invariant digital filter algorithm (paragraph 6.1, reference i). The SRS is provided by a plot of natural frequency (undamped SDOF natural frequency) versus specified mass response amplitude, and is obtained as the output of the SDOF bandpass filters when the transient shock time history acceleration serves as the input to the base. Materiel response acceleration, (usually measured at a materiel mount location or, less preferably, at a materiel subcomponent with potential for local resonant response), will generally be the variable used in characterization of the effects of the shock. This does not preclude

MIL-STD-810H
METHOD 516.8

other variables of materiel response such as velocity, displacement, or strain from being used and processed in an analogous manner, as long as the interpretation of the measurement variable is clear, and the measurement/signal conditioning configuration is valid, e.g., measurements made within the significant frequency range of materiel response, etc. If, for example, base input velocity is obtained from measurement, all relative and absolute quantities will be transformed from those based upon base input acceleration (see Annex A). It can be established that stress within materiel at a particular location is proportional to the velocity of the materiel at that same location (paragraph 6.1, references e and f). For the SDOF model, this implies that stress within the materiel is proportional to the relative velocity between the base and the mass, and not the absolute velocity of the mass. Annex A discusses the modeling of SDOF systems in more detail, and places emphasis on the fact that materiel with many resonant modes can often be thought of in terms of a series of independent SDOF systems as defined at the resonant frequencies of the materiel.



Base Input SDOF Differential Equation of Motion:

For $x(t)$ base input motion coordinate and $y(t)$ mass absolute motion coordinate

$$m\ddot{y}(t) + c\dot{y}(t) + ky(t) = kx(t) + c\dot{x}(t)$$

where for

$$m\ddot{y}(t) + c[\dot{y}(t) - \dot{x}(t)] + k[y(t) - x(t)] = 0$$

with

$$F_m(t) + F_c(t) + F_k(t) = 0$$

for

$$F_m(t) = \text{inertial force on mass } m$$

$$F_c(t) = \text{viscous damping force related to viscous damping coefficient } c$$

$$F_k(t) = \text{linear spring force related to linear spring stiffness coefficient } k$$

If

$$z(t) = y(t) - x(t)$$

then

$$m\ddot{z}(t) + c\dot{z}(t) + kz(t) = -m\ddot{x}(t)$$

or

$$\ddot{z}(t) + (c/m)\dot{z}(t) + (k/m)z(t) = -\ddot{x}(t)$$

Figure 516.8-1. Base input SDOF system model for shock considerations.

MIL-STD-810H
METHOD 516.8**2.3.1.2 Laboratory Shock Test Options.**

The following paragraphs address the various options for conduct of laboratory shock tests. Consideration will be discussed regarding availability of field data.

2.3.1.2.1 Summary.

For any configured materiel, ideally there exist “representative” field measurements of shock to which the materiel might be exposed during its life according to the LCEP. The eight procedures in this Method generally describe the scenarios in which field shock to materiel may occur. The procedures go beyond scenarios, and suggest default drop, default pulses, and/or default SRSs for applying laboratory shock. These “defaults” may have originated from field measurement data on some generic materiel in a particular configuration that were summarized and documented at one time, but this documentation no longer exists. Such lack of documentation leaves this Method with some procedures that are based upon the best laboratory test information currently available. The reality is that obtaining accurate item specific field measurements can be difficult, cost prohibitive, or not possible to acquire in a timely manner. However, to the maximum extent possible, tests based on measured data are the recommended option before use of the provided default test criteria.

NOTE: For materiel design and development, the option of tailoring of a laboratory shock test *from field measurement information* is superior to any of the test procedures within this Method, and should be the first laboratory test option. This assumes that the measurement data bandwidth and the laboratory test bandwidths are strictly compatible.

2.3.1.2.2 Test Implementation Options.

Table 516.8-II summarizes the options for the eight laboratory test procedures. The options are defined as follows:

- a. “TWR” (Time Waveform Replication), means that the measurement time history will be reproduced on the laboratory exciter with “minimal amplitude time history error” according to Method 525.2 Typically implemented using special shock package software for replication.
- b. “Drop” is an explicit free fall drop event.
- c. “Classical Pulse” refers to classical pulses to be used in testing. Classical pulses defined within this method are the terminal peak sawtooth, trapezoidal and half-sine pulses. This category is generally employed when suitable field measurement information is unavailable, and traditional testing is relied upon.
- d. “SRS” refers to cases in which an SRS is used for the test specification, and exciter shock is synthesized based upon amplitude modulated sine waves or damped sinusoids. This category may be based on the SRS equivalent of a classical pulse to reduce adverse effects associated with conducting classical shock testing on a shaker, or may be defined based upon an ensemble of measured field data. The application notes in Annex A paragraph A.1.3 are important for defining the appropriate duration for the synthesized SRS pulse.

From Table 516.8-II, it is clear that the test procedures are divided according to use of TWR, drop test procedures, classical pulses, or synthesized waveforms from SRS. TWR is considered the most realistic as it is based upon direct replication of field measured data. Software vendors have generally incorporated an option for TWR within their “shock package,” so that it is unnecessary to plan testing under specialized TWR software as called out in Methods 525.2 and 527.2, however, both of these Methods provide insight into tolerance and scaling related to a more general TWR methodology.

MIL-STD-810H
METHOD 516.8**Table 516.8-II. Laboratory Test Options.**

Procedure		Test Methodology					
		Drop ¹	Classical Pulse			SRS	TWR
			Half-Sine ²	Trapezoidal	TP Sawtooth		
I	Functional Shock		X		X	X	X
II	Transportation Shock				X	X	X
III	Fragility			X		X	
IV	Transit Drop	X					
V	Crash Hazard Shock ³				X	X	X
VI	Bench Handling	X					
VII	Pendulum Impact ⁴	X					
VIII	Catapult Launch/ Arrested Landing ⁵						X

Note 1. The Drop test includes vertical free fall towers, impact machines, and other test methods with similar equipment.

Note 2. High Speed Craft is a special case of Functional Shock that is specified in terms of classical half-sine.

Note 3. In some cases the Crash Hazard Shock may be evaluated by a constant acceleration, see paragraph 2.2.2e.

Note 4. Pendulum Impact is a test item with horizontal motion that impacts a stationary barrier.

Note 5. A Catapult Launch/Arrested Landing test can be based on a measured waveform or a two second damped ($Q=20$) sine burst of required amplitude and frequency, see the test procedure.

2.3.1.2.3 Tailoring When Measured Data Are Available - General Discussion.

Since test tailoring to field measured data is considered a superior technique for shock testing, information and guidelines in this and subsequent paragraphs are very important. Beyond the classical pulse, two techniques of shock replication in the laboratory are possible.

- a. The first technique takes a measurement shock, and conditions it for direct waveform replication on the laboratory exciter. Conditioning may consist of bandwidth limiting via lowpass, highpass, or bandpass filtering, and re-sampling into an ASCII or other general file format. Vendor packages may have this capability within the “shock package” or in a special “Time Waveform Replication (TWR) package”.
- b. The second technique takes a measurement shock, computes an SRS estimate, and subsequently uses this SRS estimate to synthesize a representative time domain reference using a “wavelet” or a damped sine-based synthesis approach. In order to maintain a reasonable correlation between the effective pulse durations in the field measured and laboratory synthesized signals, in addition to the SRS reference to be synthesized, the test operator will require knowledge of the basic temporal characteristics of the time domain signal(s) from which the reference SRS is computed. More on this subject follows in Annex A Paragraph 1.3.

MIL-STD-810H
METHOD 516.8

In summary, when test tailoring based upon available field measured data is employed, there are basically two laboratory test options available (assuming that repetition of the laboratory shock is under the guidance of the LCEP). Depending on the conditions of the test in which the data was acquired and the intended use for the data, the typical application of TWR or SRS test methods are described below.

a. TWR.

- (1) Measured shock is a single shock field measurement or highly repeatable multiple shock field measurement.
- (2) Complex shocks.
- (3) Adequate measurement or ability to predict time histories at relevant locations in order to have adequate information at mounting locations of the test article.
- (4) Examples of such measurements are catapult launches, aircraft landing, and gunfire loads.

NOTE: The bandwidth of the measurement shock and the ability of the laboratory exciter system to “replicate the bandwidth” is an important consideration under TWR. TWR input time histories may be band-limited, and yet the materiel response may have broader bandwidth as a result of mounting. This area has not been studied to any extent, and can be a function of the materiel and its mounting. Time history bandwidths that exceed the laboratory exciter bandwidth place a rather severe limitation on use of TWR for laboratory testing.

b. SRS.

- (1) Single or multiple shock measurements where SRS values fit to a statistical distribution. Confirmation of statistical trend must be made.
- (2) Sensor placement is sparse relative to the area in which it is to characterize.
- (3) The shock load is known to have a statistically high variance.
- (4) An example of SRS preference would be the shock assigned to a ground vehicle’s hull as a function of multiple terrains.

Scaling for conservatism is ill-defined, but may be applied at the discretion of the analyst.

NOTE: SRS synthesis requires not only the SRS estimate, but (1) a general amplitude correspondence with field measured or a predicted pulse, and (2) an estimate of the field measured or predicted pulse duration. In general, synthesis is applicable only for “simple shocks” (see Annex A paragraphs 1.2-1.3) with high frequency information very near the peak amplitude, i.e., for shocks whose rms duration is short. By the nature of the composition of the synthesized shock (i.e., damped sinusoids or “wavelets”), it is possible to inappropriately extend the duration of a time history that matches a given SRS to an indefinitely long time. Note also that when measurement data are available, certain shocks, in particular “complex shocks” (see Annex B), may only be adequately applied under TWR.

2.3.2 Test Conditions.

When defining shock test levels and conditions, every attempt needs to be made to obtain measured data under conditions similar to service environment conditions in the Life Cycle Environmental Profile. Consider the following test execution ranking from the most desirable to the least desirable as follows:

- a. TWR: Measured time histories summarized, and laboratory exciter shock created by way of direct reproduction of one or more selected time histories under exciter waveform control (see Method 525).

MIL-STD-810H
METHOD 516.8

- b. SRS based on Measured Data: Measured time histories summarized in the form of an SRS and laboratory exciter shock synthesized by way of a complex transient making sure that effective shock durations (T_e and T_E) for the test pulse are consistent with the measured data and the character of the synthesized waveform is “similar” to the measured time histories with respect to amplitude and zero crossings (see Annex A Paragraph 1.3 for a discussion and example of effective shock durations).
- c. SRS in the absence of Measured Data: No measured time histories but previous SRS estimates available, and laboratory exciter shock synthesized by way of a complex transient such that effective shock durations (T_e and T_E) are specified taking into consideration the nature of the environment and the natural frequency response characteristics of the materiel (see Annex A Paragraphs 1.3 and 1.4).
- d. Classical Shock Pulse: No measured time histories, but classical pulse shock descriptions available for use in reproducing the laboratory exciter shock (see Paragraph 2.3.2.3).

2.3.2.1 SRS Based on Measured Data

When measured data is available, the SRS required for the test will be determined from analytical computations. T_e and T_E required for the test will be determined from statistical processing of time history measurements of the materiel’s environment (see Annex A, Paragraph 1.3). Unless otherwise specified, the SRS analysis will be performed on the AC coupled time history for $Q = 10$ at a sequence of natural frequencies spaced at 1/12 octave or less to span a minimum bandwidth of 5 Hz to 2,000 Hz.

- a. When a sufficient number of representative shock spectra are available, employ an appropriate statistical enveloping technique to determine the required test spectrum with a statistical basis (see Annex C of this Method).
- b. When insufficient measured time histories are available for statistical analysis (only one or two time histories of like character), use an increase over the maximum of the available SRS spectra to establish the required test spectrum (if two spectra are available, determine a maximum envelope according to the ENV procedure of Annex C). The resulting spectra should account for stochastic variability in the environment, and uncertainty in any predictive methods employed. The degree of increase over measured time history spectra is based on engineering judgment, and should be supported by rationale. In these cases, it is often convenient to add either a 3 dB or 6 dB margin to the enveloped SRS, depending on the degree of test level conservatism desired (see Annex C, paragraph 4.2). Effective durations T_e and T_E for test should be taken as the respective maximums as computed from each of the measured time histories.

2.3.2.2 SRS in the Absence of Measured Data

If measured data is not available, the SRS and the corresponding values of T_e and T_E may be derived from (1) a carefully scaled measurement of a dynamically similar environment, (2) structural analysis or other prediction methods, or (3) from a combination of sources. For Procedure I (Functional Shock with Terminal Peak Sawtooth Reference Criteria), and Procedure V (Crash Hazard Shock), employ the applicable SRS spectrum from Figure 516.8-2 as the test spectrum for each axis, provided T_e and T_E of the test shock time history is in compliance with the accompanying Table 516.8-III. This spectrum approximates that of the perfect terminal-peak sawtooth pulse. General guidance for selecting the crossover frequency, F_{co} , for any classical pulse is to define it as the lowest frequency at which the corresponding SRS magnitude reaches the convergence magnitude (the constant magnitude reached in the high frequency portion of the SRS) for the damping ratio of interest. Once F_{co} is defined, the effective duration considered in the complex pulse synthesis is then defined as $T_E \leq 2/F_{co}$. This guidance allows for a longer effective duration than previous versions of this standard that were found to be too restrictive. Refer to Annex A paragraph 1.3 for additional guidance on customizing the bandwidth of the SRS and corresponding values of T_e and T_E as required.

It is recommend that the test be performed with a waveform that is synthesized from either (1) a superposition of damped sinusoids with selected properties at designated frequencies, or (2) a superposition of various amplitude modulated sine waves with selected properties at designated frequencies, such that this waveform has an SRS that

MIL-STD-810H
METHOD 516.8

approximates the SRS on Figure 2. In reality, any complex test transient with major energy in the initial portion of the time trace is suitable if it is within tolerance of this spectrum requirement over the minimum frequency range of 10 to 2000 Hz, and meets the duration requirements. Implementing a classical terminal-peak sawtooth pulse or trapezoidal pulse on a vibration exciter are the least permissible test alternatives. In the case in which a classical pulse is given as the reference criteria, it is permissible to synthesize a complex pulse based on the SRS characteristics of the referenced classical pulse. In such cases, T_e and T_E should be defined as in Table 516.8-III.

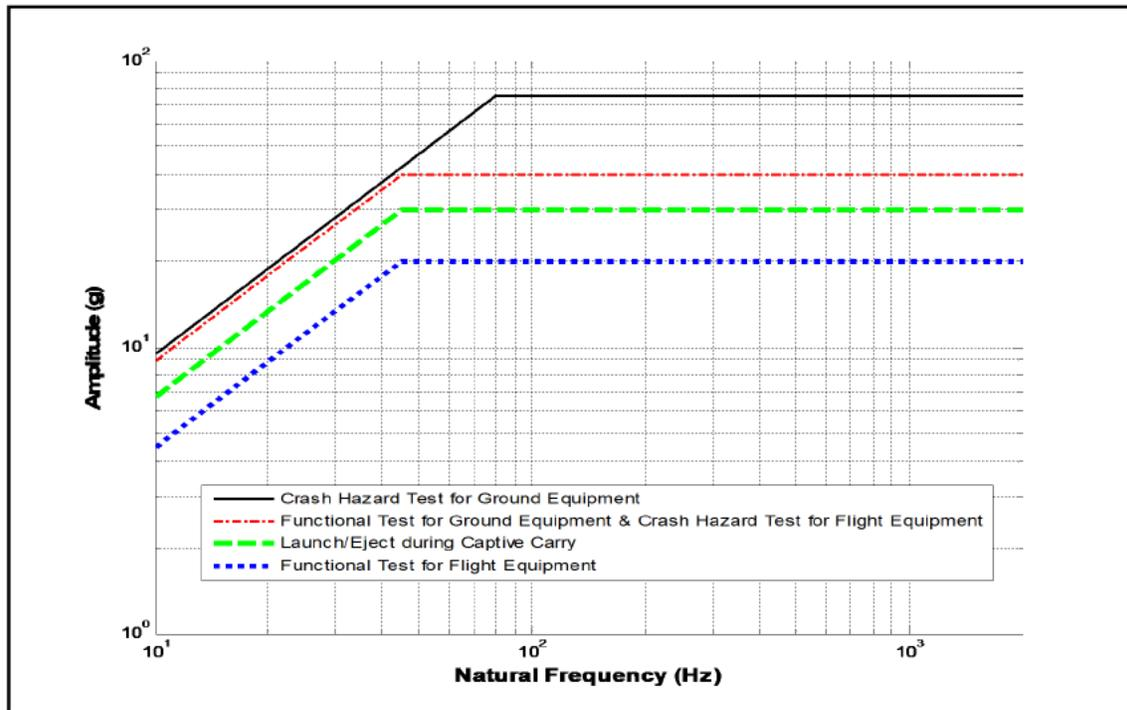


Figure 516.8-2. Test SRS for use if measured data are not available (for Procedure I - Functional Shock, and Procedure V - Crash Hazard Shock).

Table 516.8-III. Test shock response spectra for use if measured data are not available.

Test Category	Peak Acceleration (G-Pk)	T_e (ms) ¹	T_E (ms) ¹	Cross-over Frequency F_{co} (Hz)
Functional Test for Flight Equipment	20	$2.5/f_{min}$	$2/F_{co}$	45
Functional Test for Ground Equipment ²	40	$2.5/f_{min}$	$2/F_{co}$	45
Launch/Eject During Captive Carry	30	$2.5/f_{min}$	$2/F_{co}$	45
Crash Hazard Shock Test for Flight Equipment	40	$2.5/f_{min}$	$2/F_{co}$	45
Crash Hazard Shock Test for Ground Equipment	75	$2.5/f_{min}$	$2/F_{co}$	80

Note 1: The default value for f_{min} is 10 Hz as shown in Figure 516.8-2. Refer to guidance in paragraphs 4.2.2.2.c and 4.2.2.2.d to customize the bandwidth of the SRS and corresponding values of T_e and T_E .

Note 2. For materiel mounted only in trucks and semi-trailers, use a 20G peak value.

MIL-STD-810H
METHOD 516.8**2.3.2.3 Classical Shock Pulse**

Classical shock pulses (e.g., half-sine, terminal peak sawtooth, or trapezoidal) may be defined by (1) time history measurements of the materiel's environment, (2) from a carefully scaled measurement of a dynamically similar environment, (3) from structural analysis or other prediction methods, or (4) from a combination of sources. The terminal peak sawtooth is often referenced due to its relatively flat spectral characteristics in the SRS domain as approximated in Figure 516.8-2. In the event that a-priori information regarding rise time of the transient event being considered is determined to be a critical parameter, consider a half-sine pulse or a trapezoidal pulse with a tailored rising edge in lieu of the terminal peak sawtooth. Shock pulse substitution (e.g., half-sine in lieu of terminal peak sawtooth) requires adjustment in the amplitude such that the velocity of the substituted shock pulse is equivalent to the original specification. The resulting over-test or under-test with respect to the difference in the SRS must be considered, documented, and approved by the appropriate testing authority. If a classical shock pulse is defined in lieu of more complex measured time history data it must be demonstrated that SRS estimates of the classical shock pulse are within the tolerances established for the SRS estimates of the measured time history data. In most cases, classical shock pulses will be defined as one of the following:

- a. Terminal Peak Sawtooth Pulse: The terminal peak sawtooth pulse along with its parameters and tolerances are provided in Figure 516.8-3, and is an alternative for testing in Procedure I - Functional Shock, Procedure II - Transportation Shock and Procedure V - Crash Hazard Shock Test.
- b. Trapezoidal Shock Pulse: The trapezoidal pulse along with its parameters and tolerances is provided in Figure 516.8-4. The trapezoidal pulse is specified for Procedure III - Fragility.
- c. Half-Sine Shock Pulse: The half-sine pulse along with its parameters and tolerances is provided in Figure 516.8-5. The Half-Sine Pulse is specified for Procedure I - High Speed Craft Functional Shock. As discussed in paragraph 2.3.2.3.1, the half-sine pulse is often used in lieu of other classical pulses based upon equipment availability and or limitations.

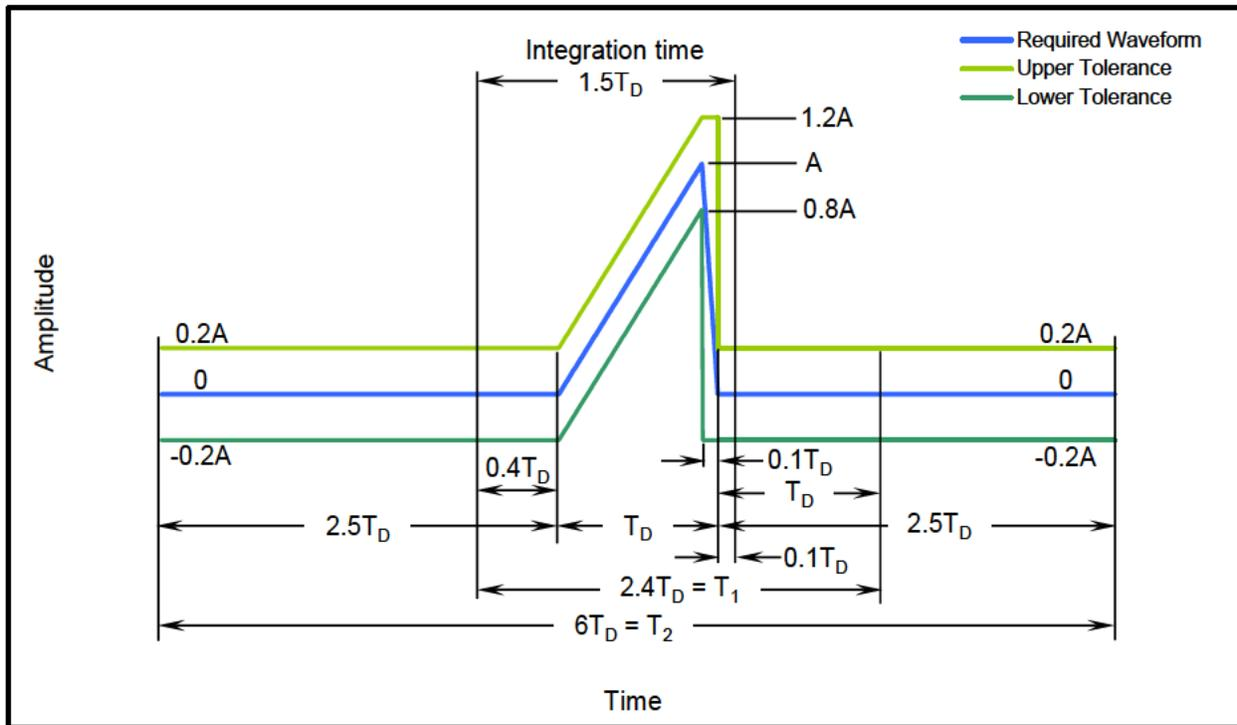
MIL-STD-810H
METHOD 516.8

Figure 516.8-3. Terminal peak sawtooth shock pulse configuration and its tolerance limits.

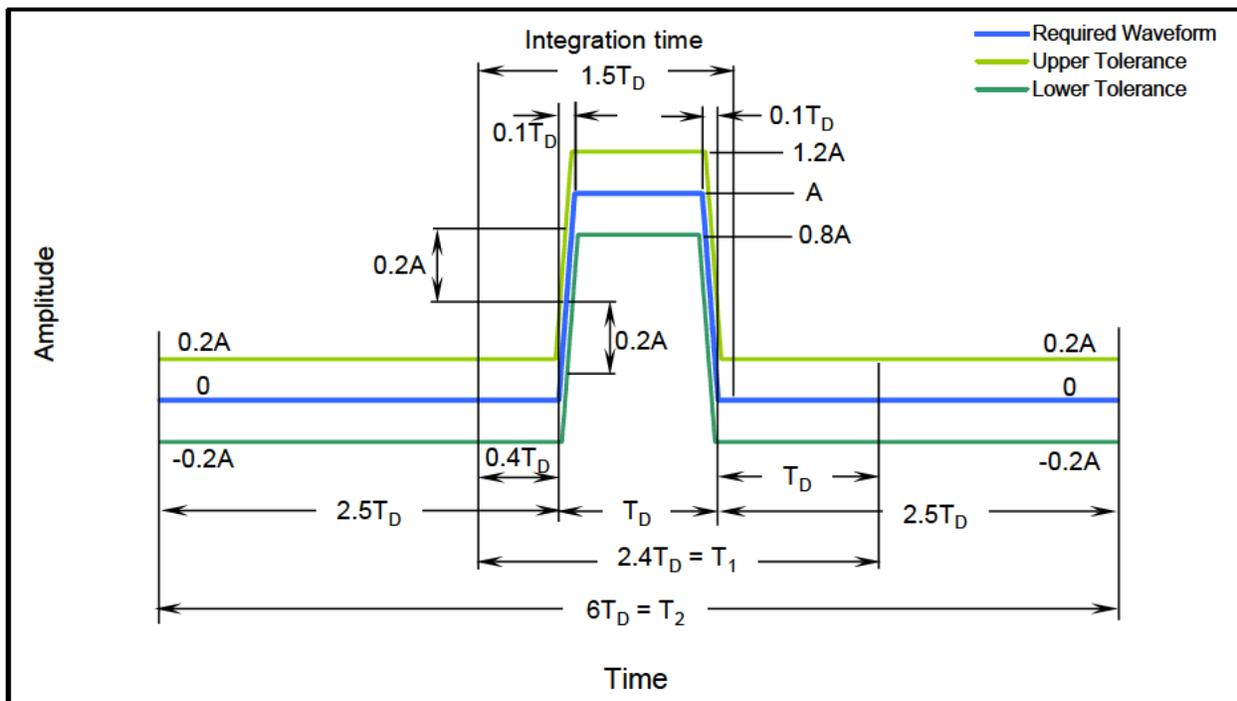


Figure 516.8-4. Trapezoidal shock pulse configuration and tolerance limits.

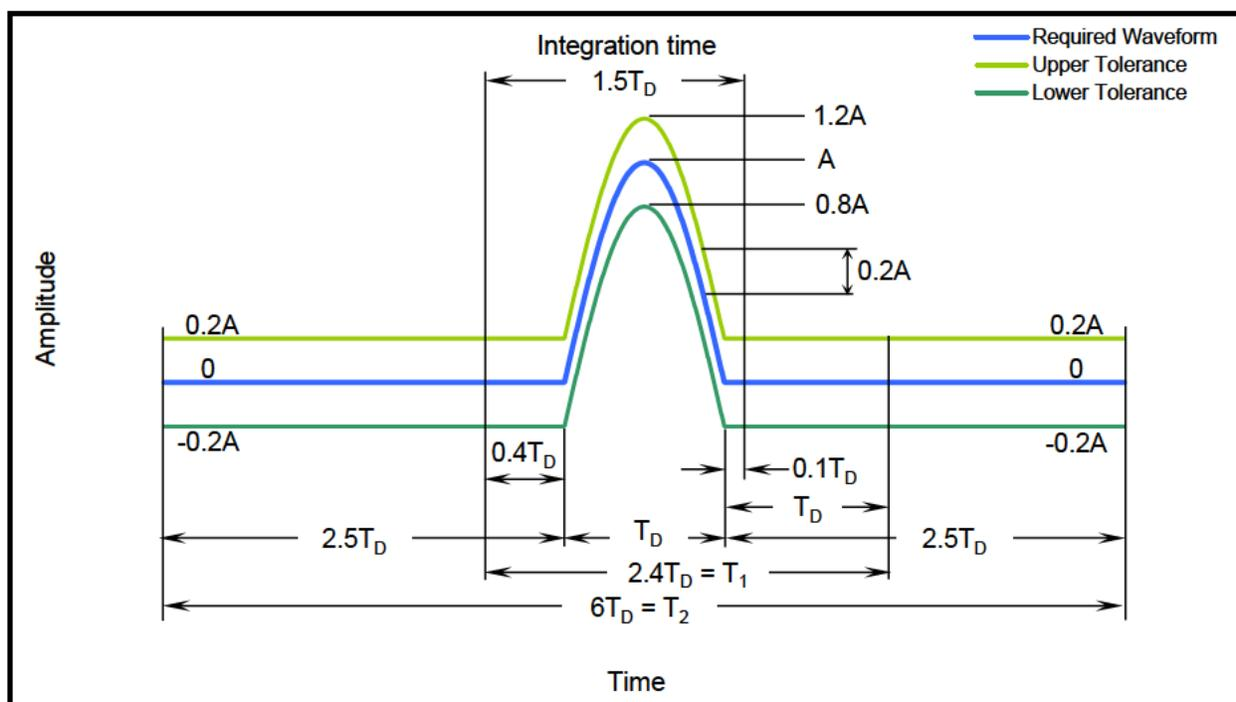
MIL-STD-810H
METHOD 516.8

Figure 516.8-5. Half-Sine shock pulse configuration and tolerance limits.

Key to Figures 516.8-3 through 516.8-5:

T_D : duration of nominal pulse (tolerance on T_D is $\pm 10\%$).

A : peak acceleration of nominal pulse

T_1 : minimum time duration which the pulse shall be monitored for shocks produced using a conventional mechanical shock machine.

T_2 : minimum time during which the pulse shall be monitored for shocks produced using a vibration exciter.

The duration associated with the post-pulse slope of a terminal peak sawtooth and durations associated with the pre and post slopes of a trapezoidal pulse should be less than 10% T_D .

The tolerance on velocity, due to combined effects of any amplitude and/or duration deviations from the nominal pulse, is limited to $\pm 20\%$ of the pulse's nominal velocity.

2.3.2.3.1 Classical Shock Pulses (Mechanical Shock Machine).

It is recognized that conducting a terminal peak sawtooth or trapezoidal pulse on a mechanical shock machine requires the use of special programmers (e.g., lead or gas programmers) and requires higher impact velocity than equivalent half-sine shocks since the half-sine pulse contains significant rebound velocity that is not characteristic of the terminal peak sawtooth pulse. Such programmers or high velocity shock machines are not available in all laboratories. In such cases, it may be necessary to resort to the use of more readily available programmers used in the conduct of half-sine shock pulses. When substitution of shock pulses is necessary, follow the general guidance of maintaining equivalent velocity to that of the original reference pulse.

2.3.2.3.2 Classical Shock Pulses (Vibration Exciter).

If a vibration exciter is to be employed to conduct a test with a classical shock pulse, it will be necessary to optimize the reference pulse such that the net velocity and displacements are zero. Unfortunately, the need to compensate the reference pulse distorts the temporal and spectral characteristics, resulting in two specific problems that will be illustrated through example using a terminal peak sawtooth (the same argument is relevant for any classical pulse test to be conducted on a vibration exciter). First, any pre and/or post-pulse compensation will be limited by the ± 20

MIL-STD-810H
METHOD 516.8

percent tolerances given in Figures 516.8-3 to 516.8-5. Second, as illustrated by the pseudo-velocity SRS in Figure 516.8-6, the velocities in the low frequency portion of the SRS will be significantly reduced in amplitude. Also, there is generally an area of increased amplitude associated with the duration of the pre- and post-test compensation. Observe that the low frequency drop-off in SRS levels between the compensated and uncompensated pulse is readily identifiable and labeled f_{low} . Likewise, the frequency at which the compensated and uncompensated pulses converge is readily identifiable and labeled f_{hi} . The drop-off at f_{low} is considered to be acceptable if and only if the lowest resonant frequency of the item being tested, f_1 , is at least one octave greater than f_{low} . The amount of gain in the region $f_{low} \leq f \leq f_{hi}$ is directly related to the duration and magnitude of the compensation pulse and the percent of critical damping employed in the SRS computation ($Q=10$ in Figure 516.8-6). The potential for over-test in this spectral band must also be carefully considered prior to proceeding.

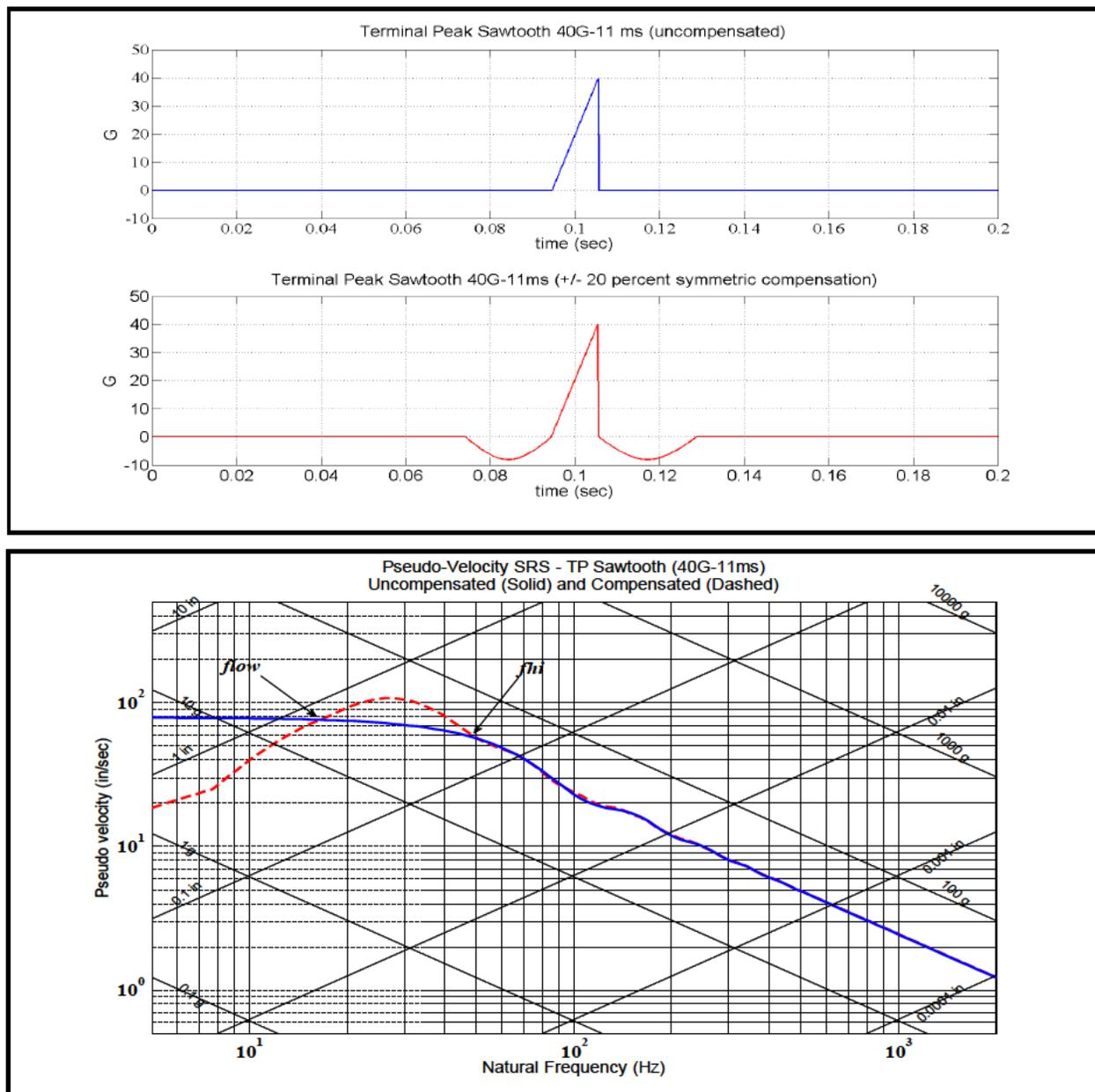


Figure 516.8-6. Illustration of temporal and spectral distortion associated with a compensated classical terminal peak sawtooth.

MIL-STD-810H
METHOD 516.8

2.3.3 Test Axes and Number of Shock Events - General Considerations.

Generally, the laboratory test axes and the number of exposures to the shock events should be determined based upon the LCEP. However as a minimum requirement, subject the test item to a sufficient number of suitable shocks to meet the specified test conditions in both directions along each of three orthogonal axes. A suitable test shock for each direction of each axis is defined to be one classical shock pulse or complex transient pulse that yields a response spectrum that is within the tolerances of the required test spectrum over the specified frequency range, and has an effective duration within the tolerance of T_E as defined in paragraph 4.2.2.2. In general, complex transient pulses generated by modern control systems will be symmetric and the maximax positive and negative SRS levels will be the same. However, this must be verified for each shock event by computing the spectra for positive and negative maximum (i.e., maximum and minimum) accelerations, generally at $Q = 10$, and at least 1/12-octave frequency intervals. If the required test spectrum can be satisfied simultaneously in both directions along an axis (i.e., symmetric pulse), one shock event will satisfy a single shock requirement for that axis in both directions. If the requirement can only be satisfied in one direction (e.g., polarity consideration for classical shock inputs, non-symmetric complex transient pulses), it is permissible to change the test setup and impose an additional shock to satisfy the spectrum requirement in the other direction. This may be accomplished by either reversing the polarity of the test shock time history or reversing the test item orientation. The following guidelines may also be applied for either classical shock pulses or complex transient pulses.

- a. For materiel that is likely to be exposed only rarely to a given shock event, perform a minimum of one shock in each direction of each axis. For shock conditions with a high potential of damage (e.g., large velocity change associated with the shock event, fragile test article), perform no more than one shock in each direction of each axis. Note that some high velocity shock tests with safety implications (i.e., crash hazard) may require two shocks in each direction of each axis.
- b. For materiel likely to be exposed more frequently to a given shock event, and there are little available data to substantiate the number of shocks, apply a minimum of three shocks in each direction of each axis.

2.3.3.1 Special Considerations for Complex Transients.

There is no unique synthesized complex transient pulse satisfying a given SRS. In synthesizing a complex transient pulse from a given SRS, and this complex transient pulse either (1) exceeds the capability of the shock application system (usually in displacement or velocity), or (2) the duration of the complex transient pulse is more than 20 percent longer than T_E , some compromise in spectrum or duration tolerance may be necessary. It is unacceptable to decompose an SRS into a low frequency component (high velocity and displacement), and a high frequency component (low velocity and displacement) to meet a shock requirement. Often an experienced analyst may be able to specify the input parameters to the complex transient pulse synthesis algorithm in order to satisfy the requirement for which the shock application system manufacturer "optimum" solution will not. Refer to paragraphs 4.2.2.2.c and 4.2.2.2.d.

2.4 Test Item Configuration.

(See Part One, paragraph 5.8.) The configuration of the test item strongly affects test results. Use the anticipated configuration of the materiel in the life cycle environmental profile. As a minimum, consider the following configurations:

- a. In a shipping/storage container or transit case.
- b. Deployed in the service environment.

3. INFORMATION REQUIRED.

3.1 Pretest.

The following information is required to conduct a shock test.

- a. General. Information listed in Part One, paragraphs 5.7, 5.9, and 5.11 of this Standard; and in Part One, Annex A, Task 405.
- b. Specific to this Method.
 - (1) Test fixture modal survey procedure.

MIL-STD-810H
METHOD 516.8

- (2) Test item/fixture modal survey procedure.
 - (3) Shock environment. Either:
 - (a) The predicted SRS or the complex shock pulse synthesis form (superposition of damped sinusoids, amplitude modulated sine waves, or other) specifying spectrum shape, peak spectrum values, spectrum break points, and pulse duration.
 - (b) The measured data selected for use in conjunction with the SRS synthesis technique outlined in the procedures. (If the SRS synthesis technique is used, ensure both the spectral shape and synthesized shock duration are as specified.)
 - (c) The measured data that are input as a compensated waveform into an exciter/shock system under Time Waveform Replication (TWR). (See Method 525.2.)
 - (d) Specified test parameters for transit drop and fragility shock.
 - (4) Techniques used in the processing of the input and the response data.
 - (5) Note all details of the test validation procedures.
- c. Tailoring. Necessary variations in the basic test procedures to accommodate LCEP requirements and/or facility limitations.

3.2 During Test.

Collect the following information during conduct of the test.

- a. General. Information listed in Part One, paragraph 5.10 and in Part One, Annex A, Task 406 of this Standard.
- b. Specific to this Method. Information related to failure criteria for test materiel under acceleration for the selected procedure or procedures. Pay close attention to any test item instrumentation, and the manner in which the information is received from the sensors. For large velocity shock, ensure instrumentation cabling does not add noise to measurements as a result of cable movement.
- c. If measurement information is obtained during the test, examine the time histories and process according to procedures outlined in the test plan.

3.3 Post-Test.

The following information shall be included in the test report.

- a. General. Information listed in Part One, paragraph 5.13 of this Standard; and in Part One, Annex A, Task 406.
- b. Specific to this Method.
 - (1) Duration of each exposure and number of exposures.
 - (2) Status of the test item after each visual examination.
 - (3) All response time histories and the information processed from these time histories. In general, under-processed information, the absolute acceleration maximax SRS, and the pseudo-velocity SRS should be supplied as a function of single degree-of-freedom oscillator undamped natural frequency. In certain cases, the ESD and FS may be supplied.
 - (4) Test item and/or fixture modal analysis data and, if available, a mounted item/fixture modal analysis.
 - (5) Any deviation from the test plan or default severities (e.g., drop surface).

4. TEST PROCESS.

4.1 Test Facility.

Use a shock-producing apparatus capable of meeting the test conditions as determined according to the appropriate paragraphs of this Method. The shock apparatus may be of the free fall, resilient rebound, non-resilient rebound, hydraulic, compressed gas, electrodynamic exciter, servo-hydraulic exciter, or other capable configuration. Careful attention needs to be paid to the time, amplitude, and frequency ranges over which the apparatus is capable of

MIL-STD-810H
METHOD 516.8

delivering a shock input. For example, electrodynamic exciters can suitably reproduce synthesized shock records from 5 Hz to 2000 Hz or above; however, a servo-hydraulic exciter may have only a DC to 500 Hz controllable frequency range. Procedures II and III require test apparatus capable of producing relatively large displacement. Procedure VII is a special test setup in that large containers impact a rigid barrier. Procedure VIII for catapult launch is best satisfied by application of two shock pulses with an intervening “transient vibration” for which TWR Method 525.2 may be appropriate. Generally, shock on either electrodynamic or servo-hydraulic exciters will be controlled using classical shock, SRS shock, or time waveform replication control software.

4.2 Controls.

4.2.1 Calibration.

The shock apparatus will be user-calibrated for conformance with the specified test requirement from the selected procedure where the response measurements will be made with traceable laboratory calibrated measurement devices. Conformance to test specifications may require use of a “calibration load” in the test setup. If the calibration load is required, it will generally be a mass/stiffness simulant of the test item. “Mass/stiffness simulants” imply that the modal dynamic characteristics of the test item are replicated to the extent possible in the simulant - particularly those modal dynamic characteristics that may interact with the modal dynamic configuration of the fixturing and/or the test device. For calibration, produce two consecutive input applications to a calibration load that satisfy the test conditions outlined in Procedures I, II, III, V, or VIII. After processing the measured response data from the calibration load, and verifying that it is in conformance with the test specification tolerances, remove the calibration load and perform the shock test on the test item. Use of calibration loads for setup to guard against excessive over test or unproductive under test is highly recommended in all cases.

4.2.2 Tolerances.

For test validation, use the tolerances specified under each individual procedure, along with the guidelines provided below. In cases in which such tolerances cannot be met, establish achievable tolerances that are agreed to by the cognizant engineering authority and the customer prior to initiation of test. In cases, in which tolerances are established independently of the guidance provided below, establish these tolerances within the limitations of the specified measurement calibration, instrumentation, signal conditioning, and data analysis procedures.

4.2.2.1 Classical Pulses and Complex Transient Pulses-Time Domain.

For the classical pulses in this Method, tolerance limits on the time domain representation of the pulses are as specified in Figures 516.8-3 through 516.8-5. If a classical shock pulse is defined in lieu of more complex measured time history data it must be demonstrated that SRS estimates of the classical shock pulse are within the tolerances established for the SRS estimates of the measured time history data. For complex transient pulses *specified* in the time domain, it is assumed that testing will be performed under TWR (Method 525.2), and that the tolerance guidance related to that Method will be used.

4.2.2.2 Complex Transient Pulses-SRS.

For a complex transient pulse specified by way of the maximax SRS, e.g., Figure 516.8-2, the frequency domain and time domain tolerances are specified in terms of a tolerance on the SRS amplitude values over a specified frequency bandwidth and a tolerance on the effective pulse duration. If a series of shocks are performed, all acceleration maximax SRS shall be computed at the center frequency of one-twelfth octave bands with a default damping quality factor Q of 10 (5 percent critical damping factor). Tolerances on the individual points (values associated with each one-twelfth octave center frequency) are to be within -1.5 dB and +3 dB over a minimum of 90 percent of the overall values in the frequency bandwidth from 10 Hz to 2000 Hz. For the remaining part of the frequency band, all SRS values are to be within -3 dB and +6 dB (this places a comparatively narrow tolerance on the major frequency band of interest, but allows a wider tolerance on 10 percent of this frequency band and a wider tolerance on the SRS above 2 KHz). Note that if an SRS is within tolerance for both SRS-minimum and SRS-maximums, the pulse is considered symmetric. While the reference criteria is often limited in bandwidth as a result of excitation equipment limitations, the analyst may require response data to be viewed through the bandwidth at which the SRS amplitude flattens. The duration of the complex transient is defined by T_e and T_E as discussed in Annex A paragraph 1.3 and shall have a tolerance of $0.8T_E \leq T_e \leq 1.2T_E$. In addition, the following guidance is provided for use of (1) the pseudo-velocity response spectra, and (2) multiple measurements to specify a shock environment.

MIL-STD-810H
METHOD 516.8

- a. All tolerances are specified on the maximax acceleration SRS. Any tolerances specified on the pseudo-velocity response spectra must be derived from the tolerances on the maximax acceleration SRS. (For three-coordinate paper, the pseudo-velocity tolerance can be determined by placing tolerance bands along the SRS acceleration axis, and then extracting the tolerance values along the ordinate for the pseudo-velocity SRS tolerance.) Note that SRS estimates scale directly in amplitude, i.e., multiplication of the time history by a factor is translated directly into multiplication of the SRS estimate by the same factor.
- b. The test tolerances are stated in terms of a single measurement tolerance, i.e., each individual laboratory test must fit within the tolerance bands to provide a satisfactory test. For an array of measurements defined in terms of a "zone" (paragraph 6.1, reference b), amplitude tolerance may be specified in terms of an average of the measurements within a "zone". However, this is, in effect, a relaxation of the single measurement tolerance in that individual measurements may be substantially out of tolerance while the average is within tolerance. In general, when specifying test tolerances based on averaging for more than two measurements within a zone, the tolerance band should not exceed the 95/50 one-sided normal tolerance upper limit computed for the logarithmically transformed SRS estimates, nor be less than the mean minus 1.5 dB. Any use of "zone" tolerances and averaging must have support documentation prepared by a trained analyst. The tolerance on the duration of the test pulse when more than one measurement is present, may be specified either as a percentage of the harmonic mean of the pulses (the n th root of the product of the n durations as defined by T_{Ej} for $j = 1, 2, \dots, n$ i.e., $T_E = \sqrt[n]{\prod_{j=1}^n \tau_j}$), or on some statistical based measure taking account of the variance of the effective durations. For example, a 95/50 two-sided normal tolerance limit will provide the upper and lower limits of duration for which it is expected that 95 percent of future measurements will fall with 50 percent confidence coefficient. 10 percent of the difference in these limits might be a reasonable duration tolerance. For further possible ways of statistically defining specification of duration tolerance see Annex C).
- c. If the test item has no significant low frequency modal response, it is permissible to allow the low frequency portion of the SRS to fall out of tolerance in order to satisfy the high frequency portion of the SRS, provided the high frequency portion begins at least one octave below the first natural mode frequency, f_1 , of the mounted test item. Recall that f_{\min} was defined to be one octave below f_1 . The reference pulse synthesis should be conducted such that as much of the spectrum below f_{\min} remains in tolerance as possible without exceeding the specified duration T_E .
- d. If the test item has significant low frequency modal response, it is permissible to allow the duration of the complex transient pulse to fall outside of the T_E range (provided in Table 516.8-III), in order to satisfy the low frequency portion of the SRS. The effective duration contained in Table 516.8-III may be increased by as much as $1/(2f_{\min})$ in addition to T_E , (e.g., $T_E + 1/(2f_{\min})$), in order to have the low frequency portion of the SRS within tolerance. If the duration of the complex transient pulse must exceed $T_E + 1/(2f_{\min})$ in order to have the low frequency portion of the SRS within tolerance, use a new shock procedure.

4.3 Test Interruption.

Test interruptions can result from two or more situations, one being from malfunction of the shock apparatus or associated laboratory test support equipment. The second type of test interruption results from malfunction of the test item itself during operational checks.

4.3.1 Interruption Due To Laboratory Equipment Malfunction.

- a. General. See Part One, paragraph 5.11 of this Standard.
- b. Specific to this Method. Interruption of a shock test sequence is unlikely to generate any adverse effects. Normally, continue the test from the point of interruption.

4.3.2 Interruption Due To Test Item Operation Failure.

Failure of the test item(s) to function as required during operational checks presents a situation with several possible options.

MIL-STD-810H
METHOD 516.8

- a. The preferable option is to replace the test item with a “new” one and restart from Step 1.
- b. A second option is to repair the failed or non-functioning component or assembly of the test item with one that functions as intended, and restart the entire test from Step 1.

NOTE: When evaluating failure interruptions, consider prior testing on the same test item, and consequences of such.

4.4 Instrumentation.

In general, acceleration will be the quantity measured to meet a specification, with care taken to ensure acceleration measurements can be made that provide meaningful data. Always give special consideration to the measurement instrument amplitude and frequency range specifications in order to satisfy the calibration, measurement and analysis requirements. With regard to measurement technology, accelerometers, strain gages and laser Doppler vibrometers are commonly used devices for measurement. In processing shock data, it is important to be able to detect anomalies. For example, it is well documented that accelerometers may offset or zero-shift during mechanical shock, pyroshock, and ballistic shock (paragraph 6.1, references m, n, and s). Additional discussion on this topic is found in the pyro shock and ballistic shock methods. A part of this detection is the integration of the acceleration amplitude time history to determine if it has the characteristics of a physically realizable velocity trace. For mechanical shock various accelerometers are readily available which may or may not contain mechanical isolation. Transducer performance continues to improve with time, however, inventories across all laboratories may not be of the latest generation, and thereby making detailed calibrations critical in understanding individual transducer performance.

- a. Accelerometers. Ensure the following:

- (1) **Amplitude Linearity:** It is desired to have amplitude linearity within 10 percent over the entire operating range of the device. Since accelerometers (mechanically isolated or not) may show zero-shift (paragraph 6.1, reference o), there is risk in not characterizing these devices over their entire amplitude range. To address these possible zero-shifts, high pass filtering (or other data correction technique) may be required. Such additional post-test correction techniques increases the risk of distorting the measured shock environment. Consider the following in transducer selection:

- (a) It is recognized that accelerometers may have both non-linear amplification and non-linear frequency content below 10,000 Hz (paragraph 6.1, reference o). In order to understand the non-linear amplification and frequency characteristics, it is recommended that shock linearity evaluations be conducted at intervals of 20 to 30 percent of the rated amplitude range (inclusive of the maximum rated range) of the accelerometer to identify the actual amplitude and frequency linearity characteristics and useable amplitude and frequency range. If a shock based calibration technique is employed, the shock pulse duration for the evaluation is calculated as:

$$T_D = \frac{1}{2f_{max}}$$

Where T_D is the duration (baseline) of the acceleration pulse and f_{max} is the maximum specified frequency range for the accelerometer. For mechanical shock, the default value for f_{max} is 10,000 Hz.

- (b) For cases in which response below 2 Hz is desired, a piezoresistive accelerometer measurement is required.
- (2) **Frequency Response:** A flat response within ± 5 percent across the frequency range of interest is required. Since it is generally not practical or cost effective to conduct a series of varying pulse width shock tests to characterize frequency response, a vibration calibration is typically employed. For the case of a high range accelerometer with low output, there may be SNR issues associated with a low level vibration calibration. In such cases a degree of engineering judgment will be required in the

MIL-STD-810H
METHOD 516.8

evaluation of frequency response with a revised requirement for flat frequency response to be within ± 1 dB across the frequency range of interest.

- (3) Accelerometer Sensitivity: The sensitivity of a shock accelerometer is expected to have some variance over its large amplitude dynamic range.
 - (a) If the sensitivity is based upon the low amplitude vibration calibration, it is critical that the linearity characteristics of the shock based "Amplitude Linearity" be understood such that an amplitude measurement uncertainty is clearly defined.
 - (b) Ideally, vibration calibration and shock amplitude linearity results should agree within 10 percent over the amplitude range of interest for a given test.
- (4) Transverse sensitivity should be less than or equal to 7 percent.
- (5) The measurement device and its mounting will be compatible with the requirements and guidelines provided in paragraph 6.1, reference a.
- (6) Piezoelectric or piezoresistive accelerometers may be used for mechanical shock in scenarios in which levels are known to be within the established (verified through calibration) operating range of the transducer, thereby avoiding non-linear amplification and frequency content.

b. Other Measurement Devices.

- (1) Any other measurement devices used to collect data must be demonstrated to be consistent with the requirements of the test, in particular, the calibration and tolerance information provided in paragraph 4.2.
- (2) Signal Conditioning. Use only signal conditioning that is compatible with the instrumentation requirements of the test, and is compatible with the requirements and guidelines provided in paragraph 6.1, reference a. In particular, filtering of the analog voltage signals will be consistent with the time history response requirements (in general, demonstrable linearity within $\pm 5^\circ$ of phase throughout the desired frequency domain of response), and the filtering will be so configured that anomalous acceleration data caused by clipping will not be misinterpreted as response data. In particular, use extreme care in filtering the acceleration signals at the amplifier output. Never filter the signal into the amplifier for fear of filtering erroneous measurement data, and the inability to detect the erroneous measurement data. The signal from the signal conditioning must be anti-alias filtered before digitizing as defined in Annex A paragraph 1.1.

4.5 Data Analysis.

- a. In subsequent processing of the data, use any additional digital filtering that is compatible with the anti-alias analog filtering. In particular, additional digital filtering must maintain phase linearity for processing of shock time histories. Re-sampling for SRS computational error control is permitted using standard re-sampling algorithms.
- b. Analysis procedures will be in accordance with those requirements and guidelines provided in paragraph 6.1, reference a. In particular, validate the shock acceleration amplitude time histories according to the procedures in paragraph 6.1, reference a. Use integration of time histories to detect any anomalies in the measurement system, e.g., cable breakage, amplifier slew rate exceedance, data clipped, unexplained accelerometer offset, etc., before processing the response time histories. If anomalies are detected, discard the invalid measured response time history. For unique and highly valued measured data, a highly trained analyst may be consulted concerning the removal of certain anomalies but, generally, this will leave information that is biased by the technique for removal of the anomaly.

MIL-STD-810H
METHOD 516.8**4.6 Test Execution.****4.6.1 Preparation for Test.**

Test preparation details will be procedure specific as discussed in the previous paragraphs. Ensure that all test specific equipment such as fixturing, environmental conditioning equipment, instrumentation and acquisition equipment has been properly calibrated, validated and documented.

4.6.1.1 Preliminary Guidelines.

Prior to initiating any testing, review the pretest information in the test plan to determine test details (e.g., procedure, calibration load, test item configuration, measurement configuration, shock level, shock duration, climatic conditions, and number of shocks to be applied, as well as the information in paragraph 3.1 above). Note all details of the test validation procedures.

4.6.1.2 Pretest Checkout.

After calibration of the excitation input device and prior to conducting the test, perform a pretest checkout of the test item at standard ambient conditions (Part One, paragraph 5.1.a) to provide baseline data. Conduct the checkout as follows:

- Step 1 Conduct a complete visual examination of the test item with special attention to stress areas or areas identified as being particularly susceptible to damage and document the results.
- Step 2 Where applicable, install the test item in its test fixture.
- Step 3 Conduct a test item operational check in accordance with the approved test plan, and document the results for compliance with Part One, paragraph 5.15.
- Step 4 If the test item operates satisfactorily, proceed to the first test. If not, resolve the problem and restart at Step 1.

4.6.1.3 Procedures' Overview.

Paragraphs 4.6.2 through 4.6.9 provide the basis for collecting the necessary information concerning the system under shock. For failure analysis purposes, in addition to the guidance provided in Part One, paragraph 5.14, each procedure contains information to assist in the evaluation of the test results. Analyze any failure of a test item to meet the requirements of the system specifications, and consider related information such as follows in paragraphs 4.6.2 through 4.6.9. It is critical that any deviations to the test or test tolerances must be approved by the appropriate test authority and must be clearly documented in the test plan and final report.

4.6.2 Functional Shock (Procedure I).

The intent of this test is to disclose materiel malfunction that may result from shocks experienced by materiel during use in the field. Even though materiel may have successfully withstood even more severe shocks during shipping or transit shock tests, there are differences in support and attachment methods, and in functional checking requirements that make this test necessary. Tailoring of the test is required when data are available, can be measured, or can be estimated from related data using accepted dynamic scaling techniques (for scaling guidance see Method 525.2). When measured field data are not available for tailoring, use the information in Figure 516.8-2 and the accompanying Table 516.8-III to define the shock test system input SRS or Tables 516.8-IV-VI for classical pulse definitions. In the calibration procedure, the calibration load will be subject to a properly compensated complex waveform in accordance with the SRS described above for electrodynamic or servo-hydraulic shock testing. In general, tests using classical pulses, e.g., terminal peak sawtooth, etc., are unacceptable unless it can be demonstrated during tailoring that the field shock environment time trace approximates such a form. If all other testing resources have been exhausted, it will be permissible to use the information on Table 516.8-IV-VI for employing a classical pulse. However, such testing must be performed in both a positive and negative direction to assure meeting the spectrum requirements on Figure 516.8-2 in both the positive and negative direction.

MIL-STD-810H
METHOD 516.8**Table 516.8-IV. Terminal peak sawtooth default test parameters for Procedures I -Functional Test (refer to Figure 516.8-3).**

Test	Reference Peak Value and Pulse Duration					
	A _m (G-Pk) & T _D (ms)					
	Flight Vehicle Materiel ¹		Weapon Launch ^{1,2} Captive Carry		Ground Materiel ^{1,3}	
Procedure I - Functional	20 G	11 ms	30 G	11 ms	40 G	11 ms

Note 1. For materiel that is shock mounted or weighing more than 136 kg (300 lbs), an 11 ms half-sine pulse of such amplitude that yields an equivalent velocity to the default terminal peak sawtooth may be employed. Equivalent Velocity Relationship: $A_{m(half\ sine)} = (\pi/4)A_{m(sawtooth)}$

Note 2. Launch Shock is a special case of Functional Shock (see paragraph 6.1k)

Note 3. For materiel mounted only in trucks and semi-trailers, use a 20G peak value.

A special category of functional shock has been established for Navy high speed craft (HSC). Tables 516.8-V and 516.8-VI document two functional standardized laboratory shock test requirements to mitigate the risk of equipment malfunction or failure of hard mounted electrical and electronics equipment in HSC due to wave impacts (reference paragraph 6.1, reference p). These test requirements are applicable for equipment with internal vibration mounts, but not applicable for equipment on shock mounts (paragraph 6.1, reference q) or for shock isolated seats (paragraph 6.1, reference r).

Two types of half-sine shock tests are required to minimize the risk of equipment malfunction or failure in HSC. The first test, (HSC-I), is to be repeated three times in each direction of the three mutually orthogonal axes. The second test, (HSC-II), employs a lower severity shock pulse which is to be repeated 800 times in each direction per axis with the nominal spacing between pulses set at 1-second intervals (in the event the previous transient has not completely decayed within the nominal 1-second, contact the proper test authority for further guidance).

HSC equipment orientation during testing should represent realistic conditions in which the equipment may experience wave impact shock. Dominant wave impact shock loads occur only in craft axes +Z (vertical up), -X (aft), and +/- Y (port/starboard). Equipment that can be installed in any orientation should be tested in positive and negative test orientations for all three equipment axes. The +X and -Z craft orientations should be omitted during Procedure I testing for equipment installed only in a vertical up orientation.

Table 516.8-V. High Speed Craft - Standardized Requirements¹ (refer to Figure 516.8-5).

Test ²	Half-Sine Pulse	
	Amplitude	Duration
HSC-I	20 G	23 ms
HSC-II	5 G	23 ms

Note 1. The half-sine classical pulse specified for HSC may not be substituted by an SRS equivalent complex pulse.

Note 2. For equipment mounted ONLY in the Z (vertical up) direction, with the exception of equipment mounted on a mast, arch, or cabin top, HSC-I X (negative aft) and +/- Y (port/starboard) axis amplitudes may be reduced to 10 G.

MIL-STD-810H
METHOD 516.8

For unique situations (e.g., high value or fragile components) where general cross platform use at any location is not anticipated, the 20 G HSC-I default amplitude may be modified as defined in Table 516.8-VI (the pulse duration will remain at 23 ms).

Table 516.8-VI: Limited Application Requirements by Craft Size¹

Craft Size		Location		
Length (ft)	Weight (Klbs)	Longitudinal Center of Gravity (LCG)	Coxswain	Bow
65-85	105-160	10 G	15 G	20 G
40-70	35-70	10 G	15 G	15 G
35-40	14-25	15 G	15 G	20 G

Note 1. The half-sine classical pulse specified for HSC may not be substituted by an SRS equivalent complex pulse.

4.6.2.1 Test Controls - Functional Shock (Procedure I).

Table 516.8-IV provides general classical shock references for functional shock. Figure 516.8-2 provides predicted input SRS for the functional shock test for use when measured data are not available, and when the test item configuration falls into one of two specified categories - (1) flight equipment, or (2) ground equipment. The durations, T_e and T_g , are defined in Annex A paragraph 1.3, and are specified in Table 516.8-III. Tables 516.8-V and VI provide classical shock defaults for the special case of HSC.

4.6.2.2 Test Tolerances - Functional Shock (Procedure I).

For complex transients from measured data, ensure test tolerances are consistent with the general guidelines provided in paragraph 4.2.2 with respect to the information provided in Table 516.8-III and accompanying Figure 516.8-2.

For classical pulse testing, the test tolerances are specified on Figures 516.8-3 thru 5 with respect to default information in Tables 516.8-IV-VI.

4.6.2.3 Test Procedure - Functional Shock (Procedure I).

- Step 1 Select the test conditions and calibrate the shock test apparatus as follows:
 - a. Select accelerometers and analysis techniques that meet or exceed the criteria outlined in paragraph 6.1, reference a.
 - b. Mount the calibration load to the shock test apparatus in a configuration similar to that of the test item. If the materiel is normally mounted on vibration/shock isolators, ensure the corresponding test item isolators are functional during the test. If the shock test apparatus input waveform is to be compensated via input/output impulse response function for waveform control, exercise care to details in the calibration configuration and the subsequent processing of the data.
 - c. Perform calibration shocks until two consecutive shock applications to the calibration load produce waveforms that meet or exceed the derived test conditions consistent with the test tolerances in paragraph 4.6.2.2 for at least the test direction of one axis.
 - d. Remove the calibration load and install the test item on the shock apparatus.
- Step 2 Perform a pre-shock operational check of the test item. If the test item operates satisfactorily, proceed to Step 3. If not, resolve the problems and repeat this step.
- Step 3 Subject the test item (in its operational mode) to the test shock input.
- Step 4 Record necessary data to show the shock met or exceeded desired test levels within the specified tolerances in paragraph 4.6.2.2. This includes test setup photos, test logs, and photos of actual shocks from the transient recorder or storage oscilloscope. For shock and vibration isolated

MIL-STD-810H
METHOD 516.8

assemblies inherent within the test item, make measurements and/or inspections to assure these assemblies did not impact with adjacent assemblies. If required, record the data to show that the materiel functions satisfactorily during shock.

- Step 5 Perform a post-test operational check of the test item. Record performance data. If the test item does not operate satisfactorily, follow the guidance in paragraph 4.3.2 for test item failure.
- Step 6 Repeat Steps 2, 3, 4, and 5 two additional times if the SRS form of specification is used and the synthesized pulse is symmetric (yielding a total of three shocks in each orthogonal axis). If the SRS based time history is not symmetric, shock in both positive and negative polarities are required (yielding a total of six shocks in each orthogonal axis). If the classical shock form of specification is used, subject the test item to both a positive and a negative input pulse (a total of six shocks in each mutually orthogonal axis).
- Step 7 Perform a post-test operational check on the test item. Record performance data, document the test sequence, and see paragraph 5 for analysis of results.

4.6.3 Transportation Shock (Procedure II).

The Transportation Shock test procedure is representative of the repetitive low amplitude shock loads that occur during logistical or tactical materiel transportation. Vibration testing excludes transient events, thus Procedure II functions with vibration testing to sequentially represent the loads that may occur. The default testing configuration is a packaged or unpackaged test item(s) in a non-operational configuration. The test procedure may also be applied to evaluate the influence of shock loading on a cargo restraint system, or an operational test item if required. The test plan should define the operational mode and testing in commercial manufacturer packaging, as fielded materiel, or a bare item that is secured or installed on the transport platform. A default classical terminal peak sawtooth shock test sequence is defined in Table 516.8-VII. Alternatively, the shock waveform applied can be tailored with measured data and implemented via shock replication techniques such as Method 525.2, Time Waveform Replication. Transportation shock tests can frequently be completed following a vibration test using an electrodynamic or servo-hydraulic test system, and the same test setup configuration.

Table 516.8-VII Procedure II - Transportation shock test sequence^{1, 2, 3}.

On Road (5000 km)⁴ Terminal Peak Sawtooth Pulse Duration: 11 ms		Off Road (1000 km)⁴ Terminal Peak Sawtooth Pulse Duration: 5 ms	
Amplitude (G-Pk)	Number of Shocks	Amplitude (G-Pk)	Number of Shocks
5.1	42	10.2	42
6.4	21	12.8	21
7.6	3	15.2	3

Note 1: The shocks set out in Table 516.8-VII must always be carried out together with ground transportation vibration testing as specified in Method 514.8, Category 4 and/or Category 20.

Note 2: The above tabulated values may be considered for both restrained cargo and installed materiel on wheeled and tracked vehicles. Transportation shock associated with two-wheeled trailers may exceed off-road levels as defined.

Note 3: The shock test schedule set out in Table 516.8-VII can be undertaken using either terminal peak sawtooth pulses applied in each sense of each orthogonal axis, or a synthesis based on the corresponding SRS that encompasses both senses of each axis.

Note 4: The above number of shocks is equivalent to the following distances: a) On-road vehicles: 5000 km; b) Off-road vehicles: 1000 km. If greater distances are required, more shocks must be applied in multiples of the figures above.

MIL-STD-810H
METHOD 516.8

4.6.3.1 Test Controls - Transportation Shock (Procedure II).

Table 516.8-VII provides the transportation shock criteria for use when measured data are not available. The durations T_e and T_E for SRS based waveform synthesis are defined in Annex A Paragraph 1.3. Table 516.8-VII is representative of wheeled ground vehicles, but is not characteristic of specific vehicles or a transportation scenario. The default shock severities shown in Table 516.8-VII have application when the purpose of the test is to address scenarios in which damage is dependent upon multiple cycle events. The levels in Table 516.8-VII were derived from classical half-sine pulses defined in paragraph 6.1, reference h. The classical half-sine pulses were converted to terminal peak sawtooth with equivalent velocities. The terminal peak sawtooth was selected due to its relatively flat SRS characteristics above the roll-off frequency. In the event field data are available, tailor the test per the LCEP.

4.6.3.2 Test Tolerances - Transportation Shock (Procedure II).

For complex transients from measured data, ensure test tolerances are consistent with the general guidelines provided in paragraph 4.2.2. For classical pulse testing, ensure the test tolerances specified in Figure 516.8-3, with respect to the information provided in Table 516.8-VII, are satisfied.

4.6.3.3 Test Procedure - Transportation Shock (Procedure II).

Generally, either the primary road or the secondary/off road shock sequence is preformed, not both sequences. Complete testing at all applicable shock amplitudes in Table 516.6-VII for the number of shocks indicated, or as defined in the test plan. The lowest amplitude shock tests are typically performed first, followed by the higher amplitude tests. If testing is required in more than one axis, repeat the procedure below for each axis and sequence of shock amplitudes.

- Step 1 Calibrate the test equipment as follows:
 - a. Mount the calibration load to the test equipment and fixture in a configuration similar to that of the actual test item. The test setup and fixture should prevent distortion of the shock waveform.
 - b. Perform calibration shocks until two consecutive shock applications reproduce waveforms that are within the test tolerance specification.
 - c. For electrodynamic test systems or other equipment with a stored drive signal, repeat the calibration to other required test amplitudes and store the drive signal. Allow sufficient time between shocks for the previous shock event to fully decay.
- Step 2 Remove the calibration load and install the test item on the test equipment.
- Step 3 Perform a pre-test inspection of the test item, and an operational test if required.
- Step 4 Subject the test item to the shock test sequence, and perform intermediate inspections or checkouts as required between shock events. Allow sufficient time between shocks for the previous shock event to fully decay.
- Step 5 If testing is required at a different amplitude, return to Step 3, or if the sequence is complete, proceed to Step 6.
- Step 6 Perform a post-test inspection of the test item, and operational test if required. Document the results, including plots of response waveforms and any pre- or post-shock anomalies. See paragraph 5 for analysis of results.

4.6.4 Fragility (Procedure III).

The intent of this test is to determine (1) the maximum level of input to which the materiel can be exposed and still continue to function as required by its operational guide without damage to the configuration, or, (2) the minimum level of input on which exposure to a higher level of input will most likely result in either functional failure or configuration damage. Determination of the fragility level is accomplished by starting at a benign level of shock as defined by a single parameter, e.g., G-level or velocity change, and proceeding to increase the level of shock by increasing the single parameter value to the test item (base input model) until:

- a. Failure of the test item occurs.
- b. A predefined test objective is reached without failure of the test item.

MIL-STD-810H
METHOD 516.8

- c. A critical level of shock is reached that indicates failure is certain to occur at a higher level of shock.

It is important in performing a fragility test to recognize that “level of input” must correlate in some positive way with the potential for materiel degradation. It is well recognized that materiel stress is directly related to materiel velocity such as might occur during vibration/shock (see paragraph 6, references e and f) and, in particular, to change in materiel velocity denoted as ΔV . Pulse duration that relates to the fundamental mode of vibration of the materiel is a factor in materiel degradation. For a drop machine with a trapezoidal pulse program, there is a simple relationship between the three variables: pulse maximum amplitude A_m (G-pk), pulse velocity change ΔV [m/sec² (in/sec²)], pulse duration T_D (seconds), and $g = 9.81\text{m/s}^2$ (386.09 in/sec²) as provided by the following formula for the trapezoidal pulse in Figure 516.8-4 (the rise time T_R and fall time T_F should be kept to the minimum duration possible to minimize the resulting increase in velocity not associated with duration T_D):

$$A_m g = \frac{\Delta V}{T_D} \quad (\text{from } \Delta V = A_m g T_D), \quad \Delta V = 2\sqrt{2gh} \quad \text{and} \quad T_D = \frac{2\sqrt{2gh}}{A_m g}$$

(technically $\Delta V = A_m g(T_D - 0.5T_R - 0.5T_F) \cong A_m g T_D$ for $T_D \gg T_R, T_F$)

It is clear that if ΔV is to be increased incrementally until failure has occurred or is imminent, it is possible to either increase T_D , A_m or both. Since T_D relates to the period of the first mounted natural frequency of the materiel (and generally failure will occur when the materiel is excited at its lower mounted natural frequencies), it is required that the test be conducted by increasing the peak amplitude, A_m , of the test alone, leaving T_D fixed.

Figure 516.8-7 provides the 100 percent rebound ΔV versus drop height h based upon the simple relationship $h = (\Delta V)^2/g$. Holding T_D fixed and incrementally increasing ΔV provides a direct relationship between A_m and ΔV with T_D serving as a scale factor.

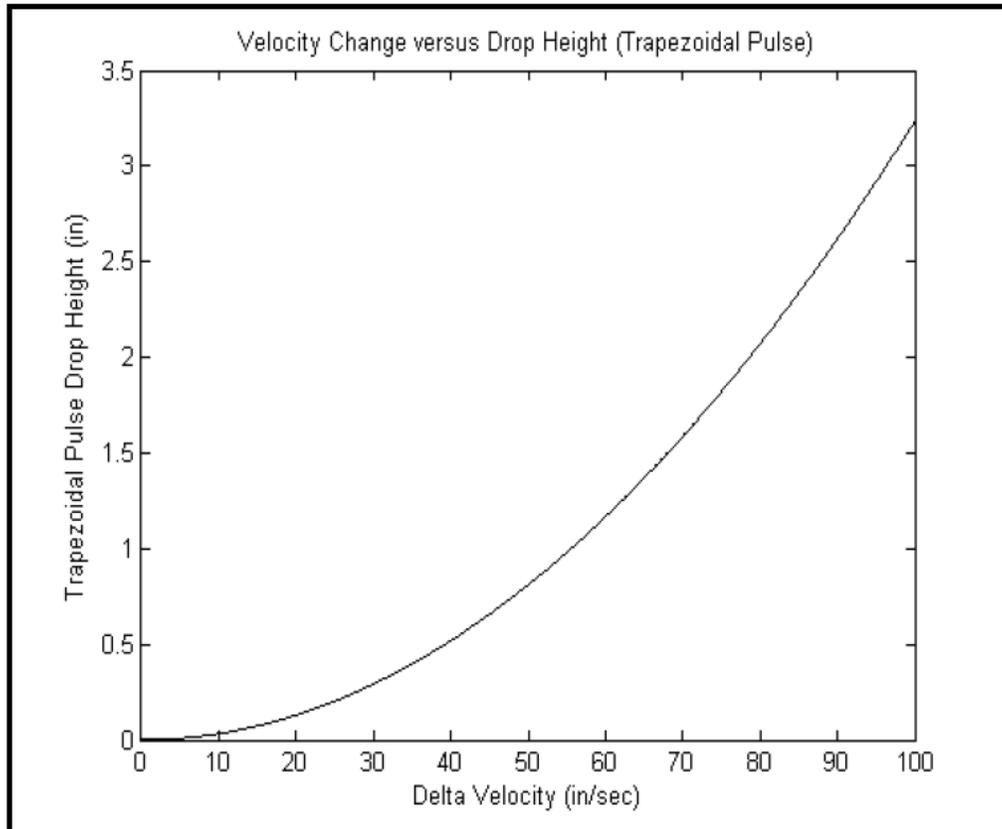
MIL-STD-810H
METHOD 516.8

Figure 516.8-7. Fragility Shock Trapezoidal Pulse: velocity change versus drop height.

Table 516.8-VIII. Fragility Shock Trapezoidal pulse parameters (refer to Figure 516.8-4).

Test	Peak Value ¹ (A_m) G's	Nominal Duration ² (T_D) (sec)
Fragility	10-50	$T_D = \frac{2\sqrt{2gh}}{A_m g} = \frac{2\sqrt{2h/g}}{A_m}$

Note 1: A_m is dependent upon drop height "h." Typical range is provided (refer to paragraph 4.6.4).

Note 2: "h" units: m (in) and $g=9.81 \text{ m/s}^2$ (386.09 in/sec^2).

For a complex transient, there is no simple relationship between peak acceleration, pulse duration, and a change in velocity. It is assumed here that for a complex transient, velocity change is related to a significant difference between successive instantaneous peaks. (This can be determined with some effort by selecting positive and negative thresholds for which a few, e.g., five or fewer, positive and negative peaks alternate over suitably short periods of time.) In this case, change in velocity is not so much an instantaneous change upon impact, but may be a successive set of changes occurring at significant periods lower than those of acceleration. (Recall that velocity is a $1/(2\pi f)$ scaling of the acceleration frequency domain information.) For test materiel where a degree of precision is needed in specifying the level of input and correlation of the shock effects on the materiel with the level of input, simple base input SDOF modeling is suggested with subsequent integration of the equations of motion to determine the relative velocity and displacement. Simply scaling the peak acceleration level (in effect the square-root of the energy) of the pulse likewise scales the velocity change directly for a linear system. The same relationship between the variables holds, except now a "distribution" of velocity change in the complex transient must be considered as opposed to a single large velocity change as in the case of the trapezoidal pulse.

MIL-STD-810H
METHOD 516.8

Paragraph 4.6.4.c above implies that an analysis of the materiel has been completed prior to testing, that critical elements have been identified with their "stress thresholds," and that a failure model of the materiel relative to the shock input level has been developed. In addition, during the test, the "stress thresholds" of these critical elements can be monitored, and input to a failure model to predict failure at a given shock input level. In general, such input to the materiel produces large velocities and large changes in velocity. If the large velocity/velocity change exceeds that available on standard electrodynamic and/or servo-hydraulic test equipment, for this procedure the classical trapezoidal pulse may be used on properly calibrated drop machines. However, if the large velocity/velocity change is compatible with the capabilities of electrodynamic and/or servo-hydraulic test equipment, consider tailoring the shock according to a complex transient for application on the electrodynamic or servo-hydraulic test equipment. Using a trapezoidal pulse on electrodynamic and/or servo-hydraulic test equipment is acceptable (accounting for pre- and post-exciter positioning) if there are no available data providing shock input information that is tailorable to a complex transient. In summary, there is a single parameter (peak amplitude of the shock input) to define the fragility level holding the duration of the shock, T_d , approximately constant. In the case of SRS synthesis, maximum velocity change is not as well defined, nor as easily controllable as for the classical trapezoidal pulse. Tailoring of the test is required when data are available, can be measured, or can be estimated from related data using accepted dynamic scaling techniques. An inherent assumption in the fragility test is that damage potential increases linearly with input shock level. If this is not the case, other test procedures may need to be used for establishing materiel fragility levels.

4.6.4.1 Test Controls – Fragility (Procedure III).

- a. Specify the duration of the shock, T_d , as it relates to the first fundamental mode of the materiel. Select a design drop height, h , based on measurement of the materiel's shipping environment, or from Transit Drop Tables 516.8-IX thru 516.8-XI as appropriate to the deployment environment when measured data are unavailable. (A design drop height is the height from which the materiel might be dropped in its shipping configuration and be expected to survive.) The maximum test item velocity change may then be determined by using the following relationship for 100% rebound:

$$\Delta V = 2\sqrt{2gh}$$

where,

ΔV = maximum product velocity change m/s (in/s) (summation of impact velocity and rebound velocity)
 h = design drop height in m (in)
 g = 9.81 m/s² (386.09 in/s²)

The maximum test velocity change assumes 100 percent rebound. Programming materials, other than pneumatic springs, may have less than 100 percent rebound, so the maximum test velocity needs to be decreased accordingly. If the maximum test velocity specified is used for drop table shock machine programming materials other than pneumatic springs, the test is conservative (an over-test), and the maximum test item velocity is a bounding requirement.

- b. Set the shock machine to an acceleration level (A_m) as determined based upon T_d and ΔV , well below the anticipated fragility level. If no damage occurs, increase A_m incrementally (along with ΔV) while holding the pulse duration T_d constant until damage to the test item occurs. This will establish the materiel's critical acceleration fragility (or velocity change) level.
- c. Test levels used in this procedure represent the correlation of the best information currently available from research and experience. Use more applicable test level data if they become available (paragraph 6.1, reference g). In particular, if data are collected on a materiel drop and the SRS of the environment computed, a scaled version of the SRS could be used to establish the acceleration fragility level with respect to a measured environment on electrodynamic or servo-hydraulic test equipment, provided the displacement and velocity limitations of the test equipment are not exceeded. In addition to the maximax acceleration response spectra, compute the pseudo-velocity response spectra.

MIL-STD-810H
METHOD 516.8**4.6.4.2 Test Tolerances – Fragility (Procedure III).**

It is assumed that the instrumentation noise in the measurements is low so that tolerances may be established. For complex transients from measured data, ensure test tolerances are consistent with the general guidelines provided in paragraph 4.2.2. For classical pulse testing, ensure the test tolerances specified in Figure 516.8-4, with respect to the information provided in Table 516.8-VIII, are satisfied.

4.6.4.3 Test Procedure – Fragility (Procedure III).

This test is designed to build up in severity as measured in peak acceleration or velocity change until a test item failure occurs, or a predetermined goal is reached. It may be necessary to switch axes between each shock event unless critical axes are determined prior to test. In general, all axes of importance will be tested at the same level before moving to another level. The order of test activity and the calibration requirements for each test setup should be clearly established in the test plan. It is also desirable to pre-select the steps in severity based on knowledge of the materiel item or the test environment, and document this in the test plan. Unless critical stress thresholds are analytically predicted and instrumentation used to track stress threshold buildup, there is no rational way to estimate the potential for stress threshold exceedance at the next shock input level. The following procedures, one for a classical pulse and the other for a complex transient, are written as if the test will be conducted in one axis alone. In cases where more test axes are required, modify the procedure accordingly.

- a. **Classical Pulse.** This part of the procedure assumes that the classical pulse approach is being used to establish the fragility level by increasing the drop height of the test item, thereby increasing the ΔV directly. The fragility level is given in terms of the measurement variable-peak acceleration of the classical pulse while holding the pulse duration as a function of the materiel modal characteristics a constant. In using this procedure, estimate the first mode mounted frequency of the materiel in order to specify the pulse duration T_D .

- Step 1 Mount the calibration load to the test apparatus in a configuration similar to that of the actual test item. Use a fixture similar in configuration to the interface of the shock attenuation system (if any) that will support the materiel. The fixture should be as rigid as possible to prevent distortion of the shock pulse input to the test item.
- Step 2 Perform calibration shocks until two consecutive shock applications to the calibration load reproduce the waveforms that are within the specified test tolerances. If response to the calibration shock is nonlinear with respect to shock input level, other test procedures may need to be applied to establish materiel fragility levels depending upon the extent of the nonlinearity prior to reaching the "stress threshold".
- Step 3 Select an initial drop height low enough to assure that no damage will occur by selecting a fraction of the anticipated service drop height established from Transit Drop Tables 516.8-IX thru 516.8-XI. The maximum velocity change can be taken to be:

$$\Delta V = 2\sqrt{2gh}$$

Where:

- ΔV = maximum test item velocity change, m/s (in/s)
(assumes full resilient rebound of test item)
- h = drop height, m (in.)
- g = acceleration of gravity 9.81 m/s² (386.09 in/s²)

- Step 4 Mount the test item in the fixture. Perform an operational check and document the pre-test condition. If the test item operates satisfactorily, proceed to Step 5. If not, resolve the problems and repeat this step.
- Step 5 Perform the shock test at the selected level, and examine the recorded data to assure the test is within tolerance.
- Step 6 Visually examine and operationally check the test item to determine if damage has occurred. If the test item does not operate satisfactorily, follow the guidance in paragraph 4.3.2 for test item failure.

MIL-STD-810H
METHOD 516.8

- Step 7 If it is required to determine the fragility of the test item in more than one axis, proceed to test the item (Steps 4-6) in the other axes (before changing the drop height).
- Step 8 If the test item integrity is preserved, select the next drop height.
- Step 9 Repeat Steps 4 through 8 until the test objectives have been met.
- Step 10 Perform a post shock operational test of the test item. See paragraph 5 for analysis of results. Document the results, including plots of the measured test response waveforms, and any pre- or post-shock operational anomalies.
- b. Synthesized Pulse. This part of the procedure assumes that the fragility level is some function of the peak acceleration level that correlates with a maximax acceleration SRS of a complex transient base input (because stress relates to velocity a peak pseudo-velocity level determined from a maximax pseudo-velocity SRS of a complex transient is preferable). For a complex transient specified in the time domain, this procedure generally uses the peak acceleration of the time history to define the fragility level.
- Step 1 Mount the calibration load to the test apparatus in a configuration similar to that of the actual test item. Use a fixture similar in configuration to the interface of the shock attenuation system (if any) that will support the materiel. The fixture should be as rigid as possible to prevent distortion of the shock pulse input to the test item.
- Step 2 Perform calibration shocks until two consecutive shock applications to the calibration load reproduce maximax acceleration SRS or pseudo-velocity SRS that are within the specified test tolerances. If response to the calibration shock is nonlinear with respect to shock input level, other test procedures along with simple modeling may need to be applied to establish materiel fragility levels, depending upon the extent of the nonlinearity prior to reaching the "stress threshold".
- Step 3 Select a peak maximax acceleration (or pseudo-velocity) SRS level low enough to assure no damage will occur.
- Step 4 Mount the test item in the fixture. Inspect and operationally test the item to document the pre-test condition. If the test item operates satisfactorily, proceed to Step 5. If not, resolve the problems and repeat this step.
- Step 5 Perform the shock test at the selected level, and examine the recorded data to assure the test maximax acceleration (or pseudo-velocity) SRS is within tolerance.
- Step 6 Visually examine and operationally check the test item to determine if damage has occurred. If so, follow the guidance in paragraph 4.3.2 for test item failure.
- Step 7 If it is required to determine the fragility of the test item in more than one axis, proceed to test the item in the other axes (before changing the peak maximax acceleration (or pseudo-velocity) SRS level).
- Step 8 If the test item integrity is preserved, select the next predetermined peak maximax acceleration (or pseudo-velocity) SRS level.
- Step 9 Repeat Steps 5 through 8 until the test objectives have been met.
- Step 10 Perform a post shock operational test of the test item. See paragraph 5 for analysis of results. Document the results, including plots of the measured test response waveforms and any pre- or post-shock operational anomalies.

4.6.5 Transit Drop (Procedure IV).

The intent of this test is to determine the structural and functional integrity of the materiel to a transit drop either outside or in its transit or combination case. In general, there is no instrumentation requirement for the test and measurement information is minimized, however, if measurements are made, the maximax acceleration SRS and the pseudo-velocity SRS will define the results of the test, along with the measurement amplitude time history.

MIL-STD-810H
METHOD 516.8**4.6.5.1 Test Controls - Transit Drop (Procedure IV).**

Test levels for this test are based on information provided in Tables 516.8-IX thru 516.8-XI. Test the item in the same configuration that is used in transportation, handling, or a combat situation. Toppling of the item following impact will occur in the field and, therefore, toppling of the test item following its initial impact should not be restrained as long as the test item does not leave the required drop surface. Levels for this test were set by considering how material in the field might commonly be dropped. Conduct all drops using a quick release hook, or drop tester. Use of a standardized impact surface is recommended for test repeatability because the surface configuration can influence test results. For most drop test requirements, steel plate on reinforced concrete is the default impact surface. The plate shall be homogenous material with a minimum thickness of 3 inches (76 mm) and Brinell hardness of 200 or greater. The plate shall be uniformly flat within commercial mill production standards, level within 2 degrees, and free of surface irregularities that may influence impact results. The concrete shall have a minimum compressive strength of 2500 psi (17 MPa), and be reinforced as required to prevent fracture during testing. In high velocity hazard classification drop scenarios (e.g. 40 ft) it is necessary for the concrete strength be 4000 psi with a minimum thickness of 24 inches. The steel plate shall be bonded and/or bolted to the concrete to create a uniform rigid structure without separation. The concrete foundation plus the impact plate mass shall be a minimum of 20 times the mass of the test item. The plate surface dimensions shall be sufficiently large to provide direct and secondary rotational impacts, and if possible rebound impacts. Guidance systems which do not reduce the impact velocity may be employed to ensure correct impact angle; however the guidance shall be eliminated at a sufficient height above the impact surface to allow unimpeded fall and rebound. Use of armor plate or similar composition steel plate is recommended to improve steel surface durability and prevent impact indentation and cuts. The impact surface shall be free from standing water, ice, or other material during testing. The most severe damage potential is impact with a non-yielding mass that absorbs minimal energy. Thus, use of a single monolithic impact mass is recommended to reduce energy transfer into the mass rather than the test item. The impact mass rigidity and energy transfer can be evaluated by measurement of the mass acceleration during testing.

Tables 516.8-IX thru 516.8-XI provide default drop conditions for transport from manufacturer to the end of its service life. Table 516.8-IX (Logistic Transit Drop Test) includes drop scenarios generally associated with non-tactical, logistical transport based on weight and test item dimensions. Table 516.8-X (Tactical Transport Drop Test) includes drop scenarios generally associated with tactical transport beyond the theatre storage area. As a default, the criteria for the tactical transport drop tests are to meet all performance requirements. For items that are incapable of meeting performance requirements, adjustments may be made to the drop height or configuration to accommodate the item performance limitations. If the drop conditions are modified, restrictions may be placed on the deployment of the item. Ensure an adequate test is performed and all deviations from this procedure are properly documented. Table 516.8-XI (Severe Tactical Transport Drop Test) includes severe drop scenarios, and the item is considered to have passed if it did not explode, burn, spread propellant or explosive material as a result of dropping, dragging or removal of the item for disposal. Other drop scenarios in the LCEP should be considered.

Realistic variations to the default values provided in Tables 516.8-IX thru 516.8-XI may be permitted when justified; e.g. large/complex systems in which specific handling considerations are identified in the LCEP may supersede the default levels provided.

Figure 516.8-8 illustrates the standard drop orientations as referenced in Tables 516.8-IX thru 516.8-XI. Figure 516.8-9 illustrates typical edge and corner drop configurations for large packages as discussed in Notes 2-4 of Table 516.8-IX.

MIL-STD-810H
METHOD 516.8**Table 516.8-IX. Logistic Transit Drop Test¹.**

Weight of Test Item & Case kg (lbs)	Largest Dimension cm (in.)	Notes	Height of Drop, h cm (in.)	Number of Drops
Under 45.4 (100) Man-packed or man-portable	Under 91 (36)		122 (48)	Drop on each face, edge and corner; total of 26 drops ⁵
	91 (36) & over		76 (30)	
45.4 - 90.8 (100 – 200) inclusive	Under 91		76 (30)	Drop on each corner; total of eight drops
	91 (36) & over		61 (24)	
90.8-454 (200 – 1000) inclusive	Under 91		61 (24)	
	91 – 152 (36 – 60)	2	61 (24)	
	Over 152 (over 60)	2	61 (24)	
Over 454 (1000)	No limit	3	46 (18)	Drop on each bottom edge. Drop on bottom face or skids; total of five drops
		4		

Note 1: Perform drops from a quick-release hook or drop tester. Orient the test item so that, upon impact, a line from the struck corner or edge to the center of gravity of the case and contents is perpendicular to the impact surface. The default drop surface is steel backed by concrete. Concrete or 5 cm (2 in) plywood backed by concrete may be selected if (a) a concrete or wood surface is representative of the most severe service conditions or (b) it can be shown that the compressive strength of the impact surface is greater than that of the test item impact point(s). Note that the shorter shock duration associated with the steel impact surface may not excite all test item resonant modes.

Note 2: With the longest dimension parallel to the floor, support the transit, or combination case with the test item within, at the corner of one end by a block 13 cm (five inches) in height, and at the other corner or edge of the same end by a block 30 cm (12 inches) in height. Raise the opposite end of the case to the specified height at the lowest unsupported corner and allow it to fall freely.

Note 3: While in the normal transit position, subject the case and contents to the edgewise drop test as follows (if the normal transit position is unknown, orient the case so the two longest dimensions are parallel to the floor):

Edgewise drop test: Support one edge of the base of the case on a sill 13-15 cm (five to six inches) in height. Raise the opposite edge to the specified height and allow it to fall freely. Apply the test once to each edge of the base of the case (total of four drops).

Note 4: For shelters without shock attenuated skids, the drop height may be reduced to 15 cm (6 in) with a 10 cm (4 in) sill for edgewise drops.

Note 5: If desired, divide the 26 drops among no more than five test items (see paragraph 4.6.5.1).

MIL-STD-810H
METHOD 516.8**Table 516.8-X. Tactical Transport Drop Test.**

Scenario	Category	Impact Velocity (m/sec)	Drop Height ¹ (m)	Configuration	# Drops / Orientation ^{3,6}		Impact Surface
Ship Transport	Storage and transport to theatre storage area, transport by ship	5.4 (17.7 ft/sec)	1.5m (5 ft)	Packaged ⁶	(minimum of 3)	Flat bottom and two faces. ⁴	Steel ^{7,8} backed by concrete
Unpackaged Handling	Infantry and man-carried equipment	5.4 (17.7 ft/sec)	1.5m (5 ft)	Unpackaged	5	Flat bottom, two faces ⁴ and two edges ⁵	Steel ^{7,8} backed by concrete
Packaged Handling	Loading and offloading from side of transport vehicle - transport by truck, forklift, & helicopter	6.4 (21 ft/sec)	2.1m (7 ft)	Packaged ⁶	5		Steel ^{7,8} backed by concrete
Helicopter	Underslung load, quick release onto land or ship	6.4 (21 ft/sec)	2.1m (7 ft)	Packaged ⁶	1	Flat bottom	Steel ^{7,8} backed by concrete
Parachute Drop ²	Low velocity drop	8.7 (28.5 ft/sec)	3.8m (12.6 ft)	Packaged with appropriate honeycomb or other shock absorbing system used in delivery	1	Flat bottom	Concrete
Parachute Drop	High velocity drop	27.3 (90 ft/sec)	38.1m (125 ft)				Concrete

Note 1: The test is not intended to encompass all credible accident conditions or severe mishandling conditions. Where the drop heights quoted are exceeded by those specified elsewhere in the table or for other phases of Service, the higher values should be substituted.

Note 2: Drop heights are provided for simulated parachute drops. This test may not fully address certain effects that can occur during parachute drops in high wind conditions. Consider different drop height and angles of impact to address these issues. Drop from aircraft may be required for airdrop certification.

Note 3: Sufficient assets are required to test in each of the orientations specified. Five standard drop orientations are listed in Table XII and illustrated in Figure 8. Consider other drop orientations if expected to have a greater damage potential. Expose each item to no more than 2 drops.

MIL-STD-810H
METHOD 516.8

Note 4: For munitions, the two faces shall be the forward and aft ends of the munition.

Note 5: For munitions, the two edges shall be at 45 degrees on the forward and aft ends.

Note 6: Unpackaged if required by LCEP or Test Plan.

Note 7: The default drop surface is steel backed by concrete. Concrete or 5 cm (2 in) plywood backed by concrete may be selected if (a) a concrete or wood surface is representative of the most severe service conditions or (b) it can be shown that the compressive strength of the impact surface is greater than that of the test item impact point(s). Note that the shorter shock duration associated with the steel impact surface may not excite all test item resonant modes.

Note 8: A steel impact surface shall have a Brinell hardness of at least 200. For test items less than 454 kg (1000 lbs) the steel plate shall be at least 2.5 cm (1 in) thick, otherwise it shall be at least 7.6 cm (3 in) thick.

Table 516.8-XI. Severe Tactical Transport Drop Test.

Scenario	Category	Impact Velocity (m/sec)	Drop Height (m)	Configuration	# Drops / Orientation ^{4,5}	
Helicopter	External Carriage on Helicopter	6.4 (21 ft/sec)	2.1m (7 ft)	Unpackaged	5	Flat Bottom, two faces ² and two edges ³
Military Land Vehicles	Includes weapons loading and off loading	7.7 (25.3 ft/sec)	3.05m (10 ft)	Unpackaged		
Aircraft	External Carriage on Fixed Wing Aircraft	7.7 (25.3 ft/sec)	3.05m (10 ft)	Unpackaged		
Crane	Accidental Crane Drop	15.5 (50.9 ft/sec)	12.2m (40 ft)	Packaged ¹		
Ship Transport	Shipboard Loading	15.5 (50.9 ft/sec)	12.2m (40 ft)	Packaged ¹	(minimum of 3)	Flat Bottom and two faces. ²
Ship Aircraft Carrier	Shipboard Loading and Handling	22.1 (72.5 ft/sec)	25m (82 ft)	Packaged ¹	5	Flat Bottom, two faces ² and two edges ³

Note 1: Unpackaged if required by LCEP or Test Plan.

Note 2: For munitions, the two faces shall be the forward and aft ends of the munition.

Note 3: For munitions, the two edges shall be at 45 degrees on the forward and aft ends.

Note 4: Sufficient assets are required to test in each of the orientations specified. Five standard drop orientations are shown listed in Table 10 and illustrated in Figure 8. Other drop orientations should be considered if expected to have a greater damage potential. Each item should be exposed to no more than 2 drops.

MIL-STD-810H
METHOD 516.8

Note 5: The default drop surface is steel backed by concrete. Concrete or 5 cm (2 in) plywood backed by concrete may be selected if (a) a concrete or wood surface is representative of the most severe service conditions or (b) it can be shown that the compressive strength of the impact surface is greater than that of the test item impact point(s). Note that the shorter shock duration associated with the steel impact surface may not excite all test item resonant modes.

Table 516.8-XII. Five standard drop test orientations.

Drop	Rectangular Packages	Cylindrical Packages
1	Flat Bottom	Horizontal (Side 1)
2	Face 1: (Left End)	Face 1: (Fwd End/Top)
3	Face 2: (Right End)	Face 2: (Aft End/Bottom)
4	Edge 1: (Bottom Right End Edge)	Edge 1: (Aft End Bottom Edge (45 Deg))
5	Edge 2: (Top Left Edge)	Edge 2: Fwd End Top Edge (45 Deg))

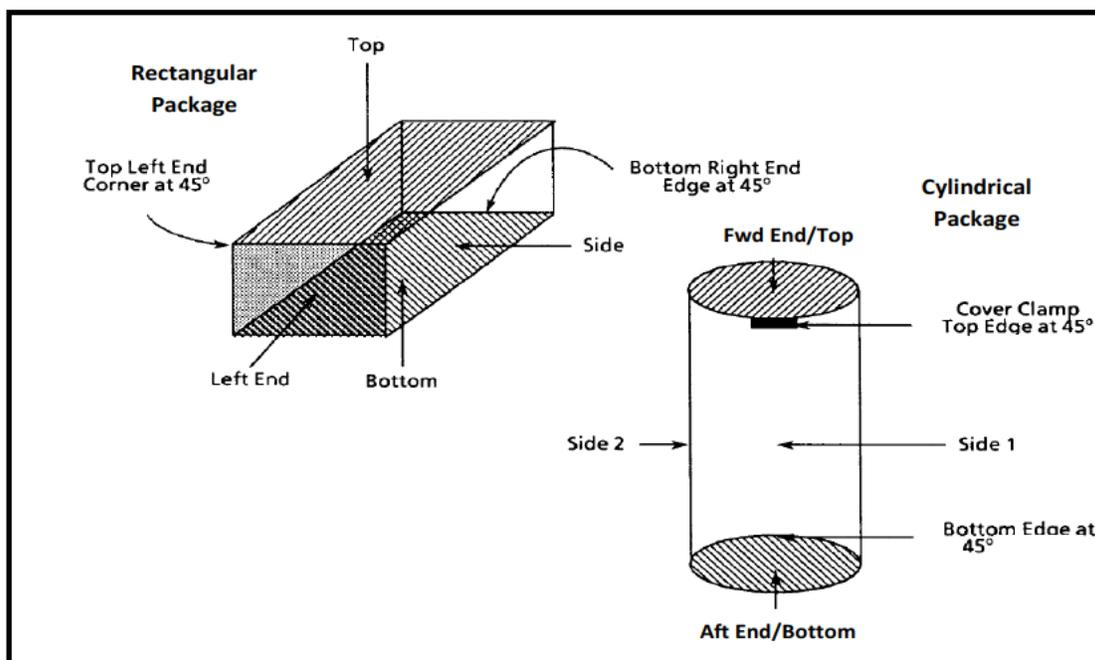


Figure 516.8-8. Standard drop orientations for rectangular and cylindrical packages.

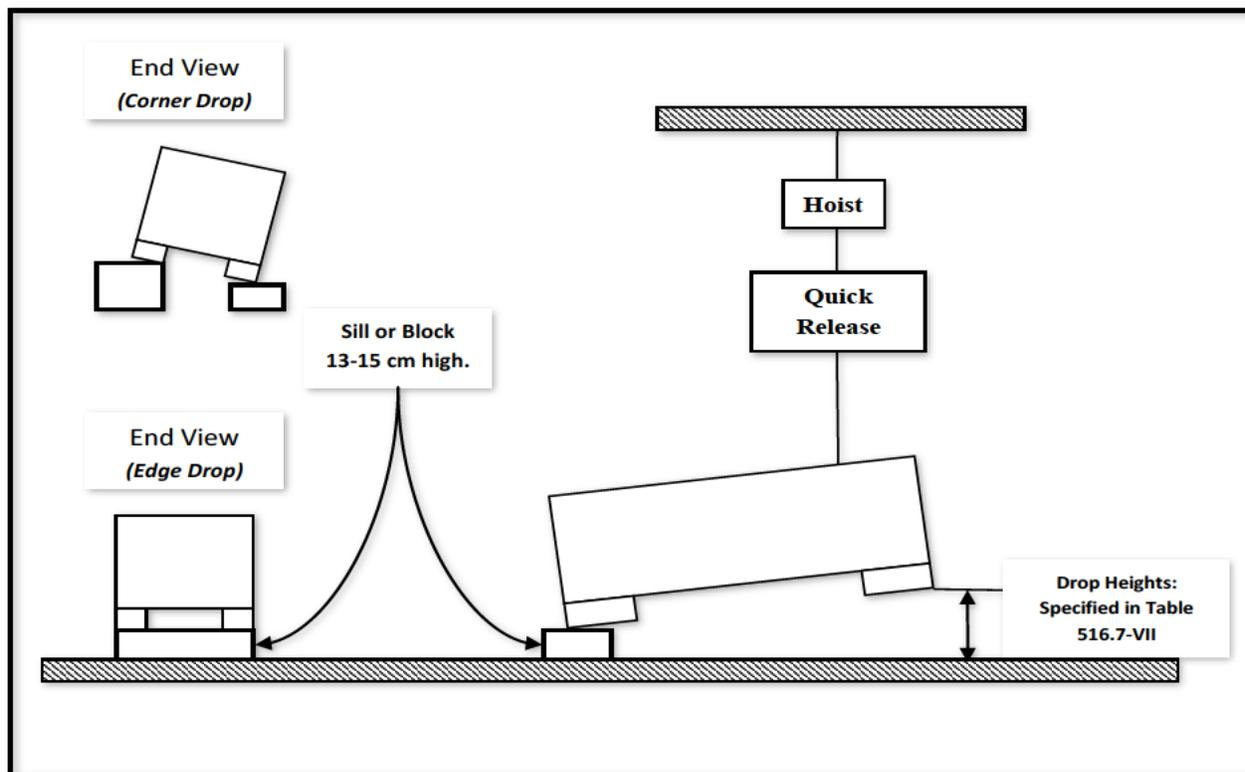
MIL-STD-810H
METHOD 516.8

Figure 516.8-9. Illustration of edge drop configuration (corner drop end view is also illustrated).

4.6.5.2 Test Tolerances - Transit Drop (Procedure IV).

Ensure the test height of drop is within 2.5 percent of the height of drop as specified in Tables 516.8-IX through 516.8-XI.

4.6.5.3 Test Procedure - Transit Drop (Procedure IV).

- Step 1 After performing a visual inspection and operational check for baseline data, install the test item in its transit or combination case as prepared for field use (if measurement information is to be obtained, install and calibrate such instrumentation in this Step). If the test item operates satisfactorily, proceed to Step 2. If not, resolve the problems and repeat this step.
- Step 2 From paragraph 4.6.5.1 and Tables 516.8-IX-516.8-XI, determine the height of the drops to be performed, drop orientation, the number of drops per test item, and the drop surface.
- Step 3 Perform the required drops using the apparatus and requirements of paragraphs 4.6.5 and 4.6.5.1 and Tables 516.8-IX through 516.8-XI notes. Recommend visually and/or operationally checking the test item periodically during the drop test to simplify any follow-on evaluation that may be required. If any degradation is noted, see paragraph 4.3.2.
- Step 4 Document the impact point or surface for each drop and any obvious damage.
- Step 5 Following completion of the required drops, visually examine the test item(s), and document the results.
- Step 6 Conduct an operational checkout in accordance with the approved test plan. See paragraph 5 for analysis of results.
- Step 7 Document the results for comparison with data obtained in Step 1, above.

MIL-STD-810H
METHOD 516.8**4.6.6 Crash Hazard Shock (Procedure V).**

The intent of this procedure is to disclose structural failures of materiel or mounts for materiel in air or ground vehicles that may present a hazard to personnel or other materiel if the materiel breaks loose from its mount during or after a vehicle crash. This test procedure is intended to verify that materiel mounting and/or restraining devices will not fail, and that sub-elements are not ejected during crash situations. Attach the test item to its shock fixture by its in-service mounting or tie-downs.

For materiel weighing less than 227 g (8 ounces) it may be permissible to omit the crash hazard test if it is determined that personnel expected to be in the vicinity of the test article are equipped with sufficient Personal Protective Equipment -PPE (i.e., helmets with visors) such that risk of significant bodily injury is determined to be highly unlikely. In addition to the item's mass, assess overall material properties and geometry when considering omitting Procedure V. Final decisions in such cases are left to the discretion of the responsible safety authority, and based upon the case-specific hazard analysis.

4.6.6.1 Test Controls - Crash Hazard Shock (Procedure V).

Use Table 516.8-III and Figure 516.8-2 as the test spectrum and effective durations. If shock spectrum analysis capabilities are not available, a classical pulse may be used as an alternative to a complex transient waveform developed from the SRS in Figure 516.8-2. Table 516.8-XIII provides the parameters for the default terminal peak sawtooth. An aircraft crash level of 40 G's is based on the assumption that, during a survivable crash, localized G levels can approach 40 G's. Ground transportation vehicles are designed with a higher safety factor and, therefore, must sustain a much higher G level with correspondingly higher specified test levels.

Table 516.8-XIII. Terminal peak sawtooth default test parameters for Procedure V – Crash Hazard (refer to Figure 516.8-3).

Test	Minimum Peak Value and Pulse Duration			
	A _m (G-Pk) & T _D (ms)			
	Flight Vehicle Materiel ¹		Ground Materiel ¹	
<i>Procedure V -Crash Hazard</i>	40 G	11 ms	75 G	6 ms

Note 1. For materiel that is shock-mounted or weighing more than 136 kg (300 lbs), an 11 ms half-sine pulse of such amplitude that yields an equivalent velocity to the default terminal peak sawtooth may be employed.

4.6.6.2 Test Tolerances - Crash Hazard Shock (Procedure V).

For complex waveform replication based on SRS, ensure the test tolerances are within those specified for the SRS in paragraph 4.2.2. For the classical terminal peak sawtooth and half-sine options defined in Table 516.8-XIII, ensure the waveform is within the tolerances specified in Figures 516.8-3 and 5.

4.6.6.3 Test Procedure - Crash Hazard Shock (Procedure V).

- Step 1 Secure the test item mount to the shock apparatus by its in-service mounting configuration. Use a test item that is dynamically similar to the materiel, or a mechanically equivalent mockup. If a mockup is used, it will represent the same hazard potential, mass, center of mass, and mass moments about the attachment points as the materiel being simulated. (If measurement information is to be collected, mount and calibrate the instrumentation.)
- Step 2 Perform two shocks in each direction (as determined in paragraph 2.3.3) along three orthogonal axes of the test item for a maximum of 12 shocks.
- Step 3 Perform a physical inspection of the test setup. Operation of the test item is not required.
- Step 4 Document the results of the physical inspection, including an assessment of potential hazards created by either materiel breakage or structural deformation, or both. Process any measurement data according to the maximax acceleration SRS or the pseudovelocity SRS.

MIL-STD-810H
METHOD 516.8**4.6.7 Bench Handling (Procedure VI).**

The intent of this test is to determine the ability of materiel to withstand the usual level of shock associated with typical bench maintenance or repair. Use this test for any materiel that may experience bench or bench-type maintenance. This test considers both the structural and functional integrity of the materiel.

4.6.7.1 Test Controls - Bench Handling (Procedure VI).

Ensure the test item is a fully functional representative of the materiel. Raise the test item at one edge 100 mm (4 in.) above a solid wooden bench top, or until the chassis forms an angle of 45° with the bench top or until point of balance is reached, whichever is less. (The bench top must be at least 4.25 cm (1.675 inches) thick.) Perform a series of drops in accordance with specifications. The heights used during this test are defined by examining the typical drops that are commonly made by bench technicians and assembly line personnel.

4.6.7.2 Test Tolerances - Bench Handling (Procedure VI).

Ensure the test height of drop is within 2.5 percent of the height of drop as specified in paragraph 4.6.7.1.

4.6.7.3 Test Procedure - Bench Handling (Procedure VI).

- Step 1 Following an operational and physical checkout, configure the item as it would be for servicing, e.g., with the chassis and front panel assembly removed from its enclosure. If the test item operates satisfactorily, proceed to Step 2. If not, resolve the problems and repeat this Step. Position the test item as it would be for servicing. Generally, the test item will be non-operational during the test.
- Step 2 Using one edge as a pivot, lift the opposite edge of the chassis until one of the following conditions occurs (whichever occurs first).
 - a. The lifted edge of the chassis has been raised 100 mm (4 in.) above the horizontal bench top.
 - b. The chassis forms an angle of 45° with the horizontal bench top.
 - c. The lifted edge of the chassis is just below the point of perfect balance.Let the chassis drop back freely to the horizontal bench top. Repeat using other practical edges of the same horizontal face as pivot points, for a total of four drops.
- Step 3 Repeat Step 2 with the test item resting on other faces until it has been dropped for a total of four times on each face on which the test item could be placed practically during servicing.
- Step 4 Visually inspect the test item.
- Step 5 Document the results.
- Step 6 Operate the test item in accordance with the approved test plan. See paragraph 5 for analysis of results.
- Step 7 Document the results for comparison with data obtained in Step 1, above.

4.6.8 Pendulum Impact (Procedure VII).

The test item (large shipping container) may consist of a box, case, crate or other container constructed of wood, metal, or other material, or any combination of these for which ordinary box tests are not considered practical or adequate. Unless otherwise specified, large containers are those that measure more than 152cm (60 in.) on any edge or diameter, or those when loaded have gross weights in excess of 70kg (154 lbs).

4.6.8.1 Test Controls - Pendulum Impact (Procedure VII).

- a. The pendulum impact tester consists of a platform suspended from a height at least 5m (16.4 ft) above the floor by four or more ropes, chains, or cables; and a bumper comprised of a flat, rigid concrete or masonry wall, or other equally unyielding flat barrier. The bumper is at least 46cm (18.1 in) high; wide enough to make full contact with the container end, and has sufficient mass to resist the impacts without displacement. The impact surface is oriented perpendicular to the line of swing of the platform. The platform is large enough to support the container or pack, and when hanging free, has its top surface approximately 23cm (9.1 in) above the floor, and its leading edge at least 8cm (3.1 in) from the surface of the bumper. The suspension

MIL-STD-810H
METHOD 516.8

chains are vertical and parallel so that when the platform is pulled straight back, it will rise uniformly but remain at all times horizontal and parallel to the floor (see Figure 516.8-10).

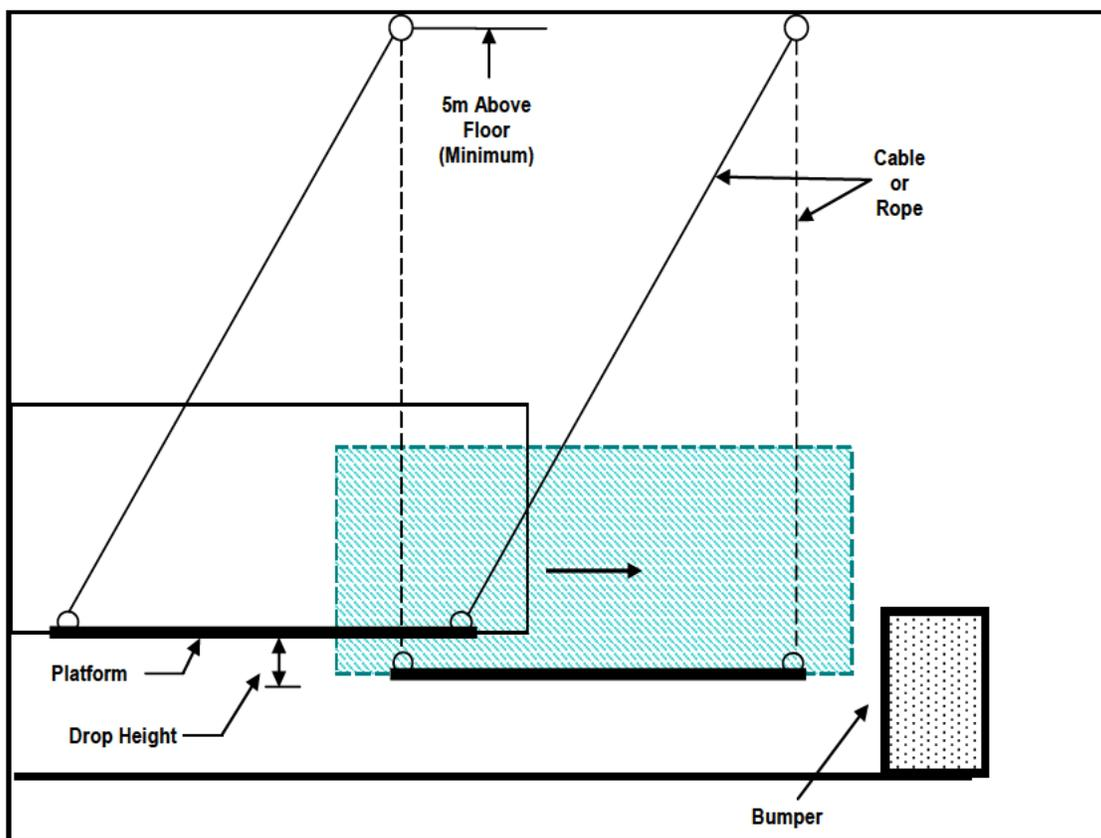


Figure 516.8-10. Pendulum impact test.

- b. The drop height shall be determined for the required horizontal impact velocity based on the transfer of potential to kinetic energy ($h = v^2/2g$). Unless otherwise specified, the vertical height is a drop of 23 cm (9 in.) that results in a velocity of 2.13m/sec (7 ft/sec) at impact.
- c. Load the test item (container) with the interior packing and the actual contents for which it was designed. If use of the actual contents is not practical, a dummy load may be substituted to simulate such contents in weight, shape, and position in the container. Block and brace the contents, or dummy load, and cushion them in place as for shipment. When the pendulum impact test is performed to evaluate the protection provided for the contents, the rigidity of a dummy load should closely approximate that of the actual contents for which the pack was designed.

4.6.8.2 Test Tolerances - Pendulum Impact (Procedure VII).

Ensure the vertical drop height is within 2.5 percent of the required height.

4.6.8.3 Test Procedure - Pendulum Impact (Procedure VII).

- Step 1 If required, perform a pretest operational checkout in accordance with the test plan. Install accelerometers and other sensors on the test item, as required.
- Step 2 Place the test item on the platform with the surface that is to be impacted projecting beyond the front end of the platform so that the specimen just touches the vertical surface of the bumper.
- Step 3 Pull back the platform so that the center of gravity of the pack is raised to the prescribed height, and then release it to swing freely so that the surface of the container impacts against the bumper. Unless

MIL-STD-810H
METHOD 516.8

otherwise specified, the vertical height is a drop of 23cm (9 in.) that results in a velocity of 2.13m/sec (7 ft/sec) at impact.

- Step 4 Examine the test item and record obvious damage. If the container is undamaged, rotate it 180 degrees and repeat Step 3. When the test is conducted to determine satisfactory performance of a container or pack, and unless otherwise specified, subject each test item to one impact to each side and each end that has a horizontal dimension of less than 3m (9.8 ft).
- Step 5 Record any changes or breaks in the container, such as apparent racking, nail pull, or broken parts, and their locations. Carefully examine the packing (blocks, braces, cushions, or other devices) and the contents, and record their condition. If required, perform a post-test operational checkout in accordance with the test plan. See paragraph 5 for analysis of results.

4.6.9 Catapult Launch/Arrested Landing (Procedure VIII).

The intent of this test is to verify the functionality and structural integrity of materiel mounted in or on fixed wing aircraft that are subject to catapult launches and arrested landings.

4.6.9.1 Test Controls - Catapult Launch/Arrested Landing (Procedure VIII).

- a. Measured Data Not Available. Whenever possible, derive the test conditions from measured data on applicable carrying aircraft (see Part One, paragraph 5.6, as well as the tasks at the end of Part One in Annex A for information on the use of field/fleet data), since shock responses can be affected by local influences such as wing and fuselage bending modes, pylon interfaces, and structural damping. While the pulse amplitudes associated with this environment are generally low, the long periods of application and high frequency of occurrence have the potential to cause significant dynamic and/or low cycle fatigue damage in improperly designed materiel. A typical aircraft may fly as many as 200 sorties per year, of which more than two-thirds involve catapult launches and arrested landings. However, for laboratory test purposes, 30 simulated catapult/arrested landing events in each of two axes (longitudinal and vertical) should provide confidence that the majority of significant defects will be identified for remedial action. If acceptable field-measured data are not available, the following guidance is offered in which sinusoidal burst is used to simulate each catapult or launch event. This time history has been simplified to a constant amplitude sine burst of 2-second duration for simulation at the selected materiel frequency (usually the first fundamental mode of the loaded aircraft wing). For testing purposes, it is permissible to reduce the maximum amplitude in the horizontal direction to 75 percent of that in the vertical direction.
- (1) Wave shape: damped sine wave.
 - (2) Wave frequency: determined by structural analysis of the specific aircraft and frequency of the fundamental mode.
 - (3) Burst amplitude: determined by structural analysis of the specific aircraft, the frequency of the fundamental mode and the location of the materiel relative to the shape of the fundamental mode.
 - (4) Wave damping (quality factor): $Q = 20$.
 - (5) Axis: vertical, horizontal, longitudinal.
 - (6) Number of bursts: determined by the specific application (for example, 30 bursts, each followed by a 10 second rest period).
- b. Measured Data Available. If acceptable field measured data are available, the following guidance is offered in which the catapult event is simulated by two shocks separated by a transient vibration, and the arrested landing event by one shock followed by transient vibration. The catapult launch/arrested landing shock environment differs from other typical shock events in that it is a transient periodic vibration (roughly sinusoidal) at a relatively low frequency determined by aircraft mass and landing gear damping characteristics. Typical catapult launch shock time histories are shown in Figure 516.8-11. These data represent measured acceleration response in the vertical, horizontal and longitudinal directions of a store component mounted on the pylon of a platform. The data are DC coupled and low pass filtered at 70 Hz. All three time histories demonstrate an initial transient, followed by a transient vibration (nearly two seconds long), and concluded by a final transient. The longitudinal axis provides a profile of the DC catapult acceleration that, in general, will not be important for testing purposes, and can be removed by high pass

MIL-STD-810H
METHOD 516.8

filtering the time history at a frequency less than 10 percent of the lowest significant frequency in the maximax acceleration SRS. Procedures for accomplishing this filtering may necessarily be iterative (unless Fourier transform information is used) with high pass filtering beginning at a comparatively high frequency, and decreasing until the most significant SRS low frequency is identified. In general, catapult acceleration response will display two shock events corresponding to initial catapult load application to the aircraft and catapult release from the aircraft separated by an oscillatory acceleration. Both the initial and the final shock events have a distinct oscillatory nature. It is essential that this test be run as a series of two shock transients separated by a two second period of time in which transient vibration may be input. Typical arrested landing shock time histories are shown on Figure 516.8-12. These data represent measured acceleration response in the vertical, horizontal and longitudinal directions of a store component mounted on the pylon of a platform. The data are DC coupled and low pass filtered at 70 Hz. All three time histories demonstrate an initial transient, followed by a transient vibration (nearly three seconds long). It is clear that the longitudinal time history has a comparatively large DC component that may be filtered out for test specification development. The term "transient vibration" is introduced here because of the duration of the event being not typical of a shock event.

NOTE: Transient Vibrations. For precise laboratory simulation, Procedure VIII may require consideration of the concept of a transient vibration in processing and replication of the form of time history from measured data. For long duration transient environments (durations on the order of one second or more), it may be useful to process the response time history by estimating the envelope function, $a(t)$, and proceeding to compute a maximax Autospectral Density Estimate (ASD), assuming short portions of the response time history behave in the same manner as stationary random data. Estimation of this form falls under the category of nonstationary time history processing and will not be considered further in this Method. For a precise definition of transient vibration, see Part One, Annex D. The importance of the transient vibration phenomenon is that (1) it has the form of a shock (short duration and substantial time varying amplitude), (2) it can be mathematically modeled in a precise way, and (3) it can be used in stochastic simulation of certain shock environments. In general, shocks have their significant energy in a shorter time frame than transient vibrations, while transient vibrations allow for time history enveloping functions other than the exponential envelope form often times displayed in shocks as a result of resonant response decay to an impact.

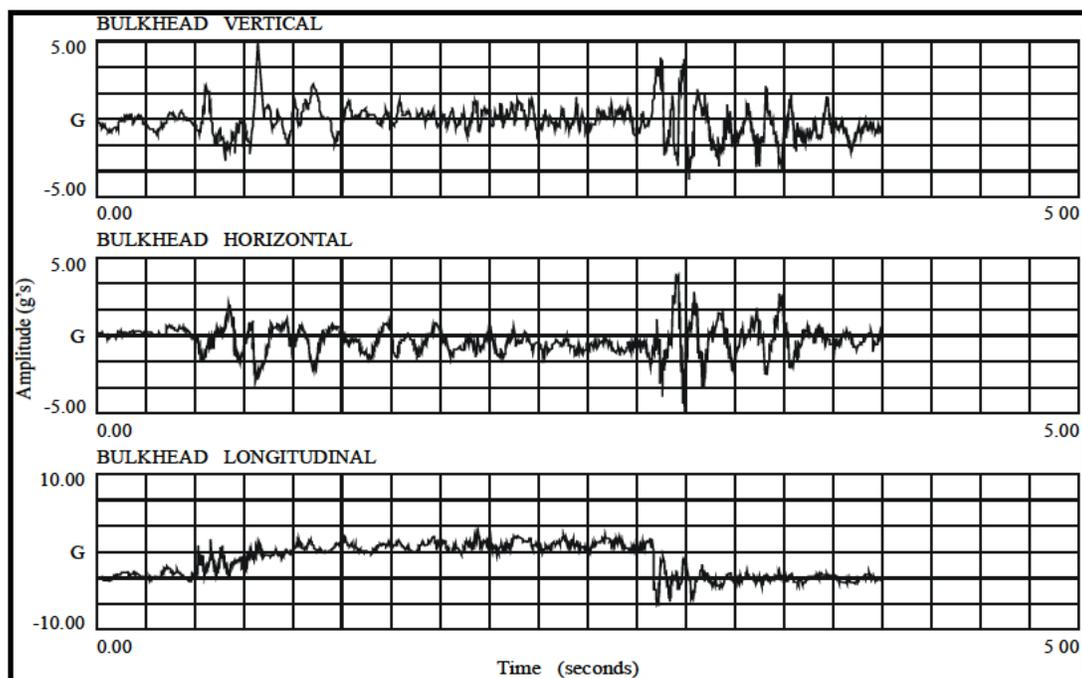


Figure 516.8-11. Sample measured store three axis catapult launch component response acceleration time histories.

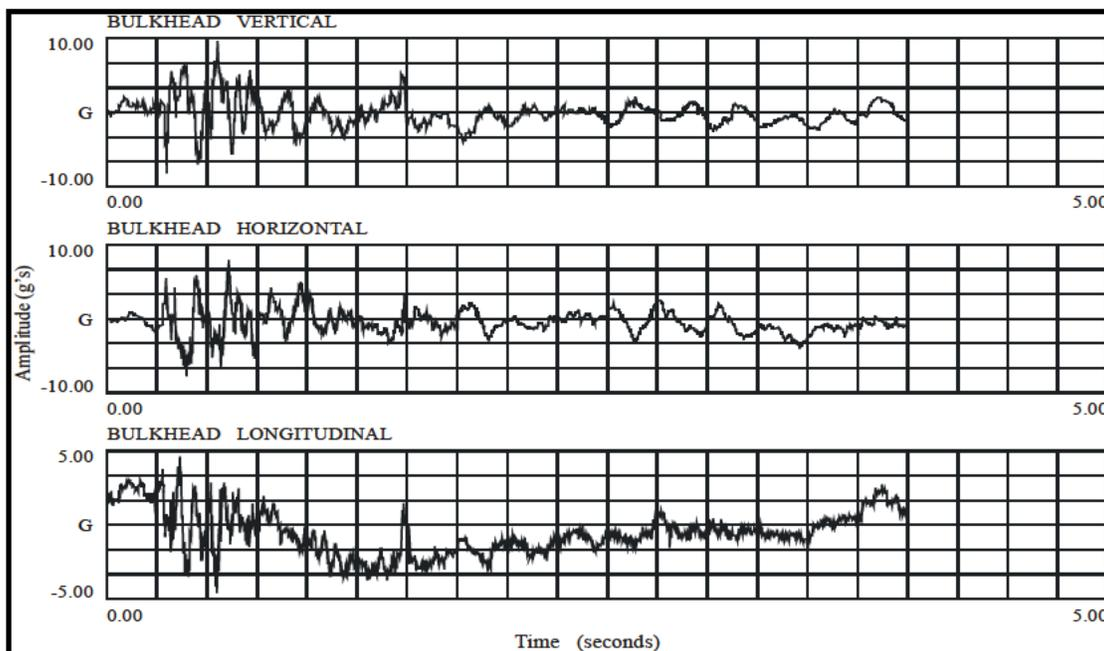
MIL-STD-810H
METHOD 516.8

Figure 516.8-12. Sample measured store three axis arrested landing component response acceleration time histories.

4.6.9.2 Test Tolerances - Catapult Launch/Arrested Landing (Procedure VIII).

For cases in which measured data are not available and waveforms are generated from dynamic analysis of the configuration, ensure the waveform tolerances are within the time history test tolerances specified for waveforms in paragraph 4.2.2. For cases in which measured data are available, ensure the SRS for the test response is within the SRS tolerances specified in paragraph 4.2.2. For transient vibration, ensure the waveform peaks and valleys are within the tolerances given for waveforms in paragraph 4.2.2 or as provided in the test specification.

4.6.9.3 Test Procedure - Catapult Launch/Arrested Landing (Procedure VIII).

- Step 1 Mount the test item to its shock/vibration fixture on the shock device for the first test axis.
- Step 2 Attach instrumentation as required in the approved test plan.
- Step 3 Conduct an operational checkout and visual examination in accordance with the approved test plan. If the test item operates satisfactorily, proceed to Step 4. If not, resolve the problems and repeat this step.
- Step 4a If no measured field data are available, apply short transient sine waves of several cycles to the test item in the first test axis. (Each short transient sine wave of several cycles represents a single catapult or arrested landing event.) Follow each burst by a rest period to prevent unrepresentative effects. Operate the test item in its appropriate operational mode while bursts are applied. If the test item fails to operate as intended, follow the guidance in paragraph 4.3.2 for test item failure.
- Step 4b If measured field data are available, either apply the measured response data under exciter system time waveform control (see Method 525.2), or process the catapult as two shocks separated by a transient vibration, and the arrested landing as a shock followed by a transient vibration. Operate the test item in its appropriate operational mode while bursts are applied. If the test item fails to operate as intended, follow the guidance in paragraph 4.3.2 for test item failure.
- Step 5 If the test item has not malfunctioned during testing, conduct an operational checkout and visual examination in accordance with the approved test plan. If a failure has occurred, it may be desirable to perform a thorough visual examination before proceeding with the operational checkout to avoid initiating additional hardware damage. When a failure occurs, consider the nature of the failure and corrective action, along with the purpose of the test (engineering information or contractual

MIL-STD-810H
METHOD 516.8

compliance) in determining whether to restart the test or to continue from the point of interruption. If the test item does not operate satisfactorily, follow the guidance in paragraph 4.3.2 for test item failure.

Step 6 Repeat Steps 1 through 5 for the second test axis.

Step 7 Document the test results including amplitude time history plots, and notes of any test item operational or structural degradation. See paragraph 5 for analysis of results.

5. ANALYSIS OF RESULTS.

In addition to the specific guidance provided in the test plan and the general guidance provided in Part One, paragraphs 5.14 and 5.17; and Part One, Annex A, Task 406, refer to the below paragraphs for supplemental test analysis information. Analyze any failure of a test item to meet the requirements of the materiel specifications.

- a. Procedure I (Functional Shock) - Consider any interruption of the materiel operation during or after the shock in relationship to the materiel's operational test requirements. (See paragraph 4.3.2.)
- b. Procedure II (Transportation Shock) - Consider any damage to the shock mounts or the internal structural configuration of the test item that may provide a cause for the development of a failure analysis course of action to consider retrofit or redesign.
- c. Procedure III (Fragility) - The outcome of a successful fragility test is one specified measurement level of test item failure for each test axis along with the duration of the shock. Consider that if the test item fails either operationally or structurally at the lowest level of testing, and there is no provision for testing at lower levels, the test item's fragility level is indeterminate.
- d. Procedure IV (Transit Drop) - In general, analysis of results will consist of visual and operational comparisons for before and after test. Measurement instrumentation and subsequent processing of acceleration time history information can provide valuable information related to response characteristics of the test item and statistical variation in the shock environment.
- e. Procedure V (Crash Hazard Shock) - If measurement information was obtained, process this in accordance with paragraph 4.6.6.3, Step 4.
- f. Procedure VI (Bench Handling) - In general, any operational or physical (mechanical or structural) change of configuration from Step 1 in paragraph 4.6.7.3 must be recorded and analyzed.
- g. Procedure VII (Pendulum Impact) - In general, analysis of the results will consist of visual inspections and any operational comparisons before and after the test. Check for operability and inspect for physical damage of the contents (except when using a dummy load). Damage to the exterior shipping container that is the result of improper interior packaging, blocking, or bracing is cause for rejection. Structural damage to the exterior shipping container that results in either spilling of the contents or failure of the container in subsequent handling is cause for rejection. Assess whether a substantial amount of shifting of the contents within the shipping container created conditions likely to cause damage during shipment, storage, and reshipment of the container. Minor container damage such as chipping of wood members, dents, paint chipping, is not cause for rejection. If recorded, acceleration time histories or other sensor data can provide valuable information related to the response characteristics of the test item.
- h. Procedure VIII (Catapult Launch/Arrested Landing) - Consider any failure of the structural configuration of the test item, mount, or launcher that may not directly impact failure of the operation of the materiel, but that would lead to failure under in-service conditions.

6. REFERENCE/RELATED DOCUMENTS.

6.1 Referenced Documents.

- a. Handbook for Dynamic Data Acquisition and Analysis, IES-RD-DTE012.2, Institute of Environmental Sciences and Technology, Arlington Place One, 2340 S. Arlington Heights Road, Suite 100, Arlington Heights, IL 60005-4516; Institute of Environmental Sciences and Technology.
- b. Piersol, Allan G., Determination of Maximum Structural Responses From Predictions or Measurements at Selected Points, Proceedings of the 65th Shock and Vibration Symposium, Volume I, SAVIAC, 1994. Shock & Vibration Exchange (SAVE), 1104 Arvon Road, Arvon, VA 23004.

MIL-STD-810H
METHOD 516.8

- c. MIL-DTL-901, "Detail Specification – Shock Tests, H.I. (High Impact), Shipboard Machinery, Equipment and Systems, Requirements for", 20 June 2017.
- d. MIL-STD-331, "Fuzes, Ignition Safety Devices and Other Related Components, Environmental and Performance Test for", May 2017.
- e. Gaberson, H. A. and Chalmers, R. H., Modal Velocity as a Criterion of Shock Severity, Shock and Vibration Bulletin 40, Pt. 2, 1969, pp.31-49.
- f. Piersol, Allan G., and T. L. Paez, eds., Harris' Shock and Vibration Handbook, 6th Edition, NY, McGraw-Hill, 2010.
- g. AR 70-44, DoD Engineering for Transportability; Information Handling Services.
- h. DEF-STAN-00-35, Part 3, Test M3, Issue 4, 10, July, 2006.
- i. Smallwood, David O., "Generating Ramp Invariant Filters for Various forms of the Shock Response Spectrum", 76th Shock and Vibration Symposium, 2005.
- j. Bendat, J. S. and Piersol, A. G., Random Data: Analysis and Measurement Procedures-Fourth Edition, John Wiley & Sons Inc., New York, 2010.
- k. Smallwood, D. O., "Characterization and Simulation of Transient Vibrations Using Band Limited Temporal Moments", Shock and Vibration, Vol. 1, No. 6, pp.507-527, John Wiley and Sons, 1994.
- l. Edwards, Timothy, "Power Delivered to Mechanical Systems by Random Vibrations", Proceedings of the 79th Shock and Vibration Symposium, Orlando, Florida, October 2008.
- m. Chu, A., "Zeroshift of Piezoelectric Accelerometers in Pyroshock Measurements," Proceedings of the 58th Shock & Vibration Symposium, Huntsville, AL, October 1987.
- n. Plumlee, R. H., "Zero-Shift in Piezoelectric Accelerometers," Sandia National Laboratories Research Report, SC-RR-70-755, March 1971.
- o. Bateman, V. I., "Accelerometer Isolation for Mechanical Shock and Pyroshock," Proceedings of the 82nd Shock and Vibration Symposium, Baltimore, MD, November, 2011 (paper) and ESTECH2012, Orlando, FL, May 2012.
- p. Riley, Michael R., Murphy, H.P., Coats, Dr. Timothy W., Petersen, Scott M., "Standardized Laboratory Test Requirements for Hardening Equipment to Withstand Wave Impact Shock in Small High-Speed Craft", Naval Surface Warfare Center Carderock Division Report NSWCCD-80-TR-2017/002, February 2017.
- q. Riley, Michael R., Petersen, S.M., "The Use of Shock Isolation Mounts in Small High-Speed Craft to Protect Equipment from Wave Slam Effects", Naval Surface Warfare Center Carderock Division Report NSWCCD-80-TR-2017/022, July 2017.
- r. Riley, Michael R., Ganey, Dr. H. Neil., Haupt, Kelly, Coats, Dr. Timothy W., "Laboratory Test Requirements for Marine Shock Isolation Seats", Naval Surface Warfare Center Carderock Division Report NSWCCD-80-TR-2015/010, May 2015.
- s. V. I. Bateman, H. Himelblau, and R. G. Merritt, "Validation of Pyroshock Data," Journal of the IEST, October 2012.

6.2 Related Documents.

- a. Conover, W.J., Practical Nonparametric Statistics. New York; Wiley, 1971, Chapter 3.
- b. Piersol, A.G., Analysis of Harpoon Missile Structural Response to Aircraft Launches, Landings and Captive Flight and Gunfire. Naval Weapons Center Report #NWC TP 58890. January 1977.
- c. Schock, R. W. and Paulson, W. E., TRANSPORTATION A Survey of Shock and Vibration Environments in the Four Major Modes of Transportation, Shock and Vibration Bulletin #35, Part 5, February 1966.

MIL-STD-810H
METHOD 516.8

- d. Ostrem, F. E., TRANSPORTATION AND PACKAGING, A Survey of the Transportation Shock and Vibration Input to Cargo, Shock and Vibration Bulletin #42, Part 1, January 1972. Shock & Vibration Exchange (SAVE), 1104 Arvon Road, Arvon, VA 23004.
- e. Allied Environmental Conditions and Test Procedure (AECTP) 400, Mechanical Environmental Tests (under STANAG 4370), Methods 403, 416, and 417.
- f. MIL-STD-209K, Lifting and Tiedown Provisions.
- g. DOD Directive 4510.11, DOD Transportation Engineering.
- h. Egbert, Herbert W. "The History and Rationale of MIL-STD-810 (Edition 2)", January 2010, Institute of Environmental Sciences and Technology, Arlington Place One, 2340 S. Arlington Heights Road, Suite 100, Arlington Heights, IL 60005-4516.
- i. ANSI/ASTM D3332, Standard Test Methods for Mechanical-Shock Fragility of Products, Using Shock Machines; Information Handling Services.
- j. Fackler, Warren C, "Equivalence Techniques for Vibration Testing", SVM-9, The Shock Vibration Information Center, Naval Research Laboratory, Washington D.C., 1972.
- k. Miles, J., On Structural Fatigue Under Random Loading", J. Aeronaut. Sci. 21, 753-762, November 1954.

(Copies of Department of Defense Specifications, Standards, and Handbooks, and International Standardization Agreements are available online at <https://assist.dla.mil>.)

Requests for other defense-related technical publications may be directed to the Defense Technical Information Center (DTIC), ATTN: DTIC-BR, Suite 0944, 8725 John J. Kingman Road, Fort Belvoir VA 22060-6218, 1-800-225-3842 (Assistance--selection 3, option 2), <http://www.dtic.mil/dtic/>; and the National Technical Information Service (NTIS), Springfield VA 22161, 1-800-553-NTIS (6847), <http://www.ntis.gov/>.

MIL-STD-810H
METHOD 516.8 ANNEX A

METHOD 516.8, ANNEX A

MEASUREMENT SYSTEM CHARACTERIZATION AND BASIC PROCESSING

1. SINGLE SHOCK EVENT MEASUREMENT SYSTEM CHARACTERIZATION AND BASIC PROCESSING

The following paragraphs discuss basic measurement system acquisition characteristics, followed by a discussion on the correct identification of the parts of a measured shock (in particular the duration of a shock). Information in Annex A is essential for the processing of measured data for a laboratory test specification.

1.1 Measurement System and Signal Conditioning Parameters

The data recording instrumentation shall have flat frequency response to the maximum frequency of interest (f_{Max}). If f_{Max} is not specified, a default value of 10 KHz is recommended for acquisition at each measurement location. Defining f_{AA} as the 3dB half-power point cut-off frequency of the low-pass analog anti-alias filter, $f_{max} < f_{AA}$ is implied to maintain flat frequency response. The digitizing rate must be at least 2.5 times the filtering frequency f_{Max} . Note that when measurements of peak amplitude are used to qualify the shock level, a sample rate of at least 10 times the filtering frequency (100 thousand samples per second for the default case) is required. For SRS considerations a measurement shock should be acquired at 10 times the filtering frequency or resampled to 10 times the filtering frequency.

It is imperative that a responsibly designed signal conditioning system be employed to reject possibility of any aliasing. Analog anti-alias filters must be in place before the digitizing portion of the signal conditioning system. The selected anti-alias filtering must have an amplitude attenuation of 50 dB or greater, and a pass band flatness within one dB across the frequency bandwidth of interest for the measurement (see Figure 516.8-1a). Subsequent re-sampling for either up-sampling (interpolation) or down-sampling (decimation) must be in accordance with standard practices and consistent with the analog anti-alias configuration.).

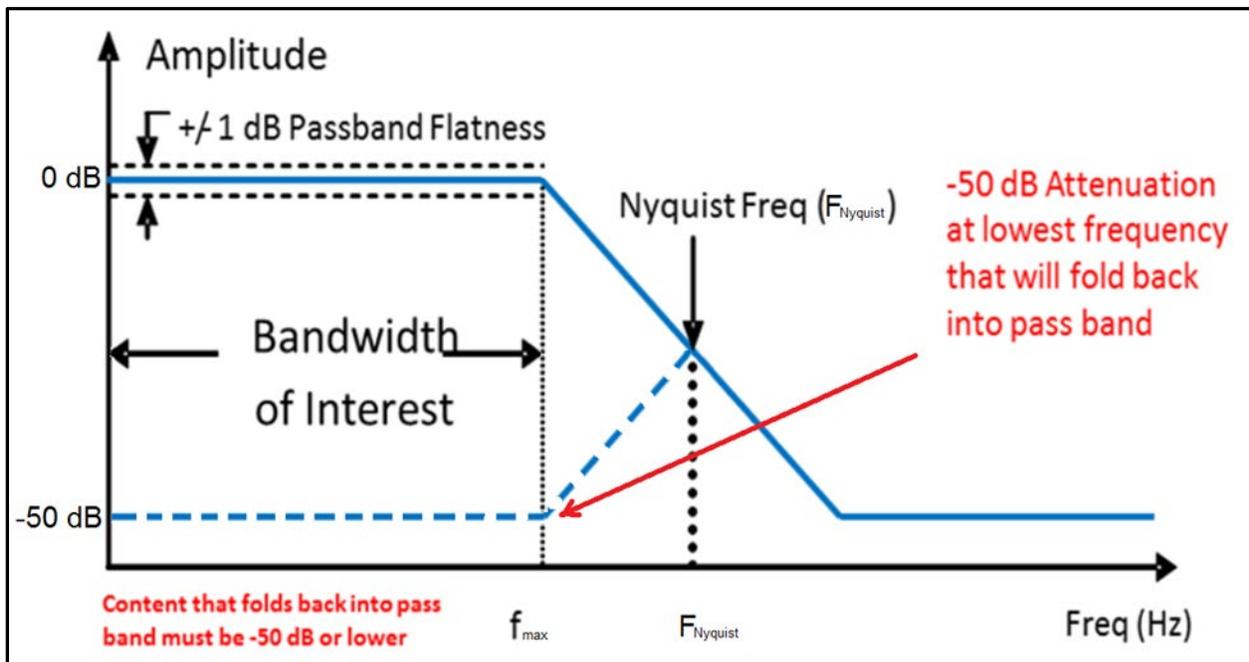


Figure 516.8A-1a. Filter attenuation (conceptual, not filter specific).

The end to end alias rejection of the final digitized output must be shown to meet the requirements in Figure 516.8 A-1a. The anti-alias characteristics must provide an attenuation of 50 dB or greater for frequencies that will fold back into the bandwidth of interest (passband). Generally, for validly acquired digital shock time history data spectral data including SRS plots are only presented for frequencies within the passband (up to f_{Max}). However, this restriction is

MIL-STD-810H
METHOD 516.8 ANNEX A

not to constrain digital data validation procedures that require assessment of digitally acquired data to the Nyquist frequency (either for the initial Analog to Digital Conversion (ADC) or subsequent re-sampled sequences). It should be noted that it is possible that certain sensor/signal conditioning systems may display substantial “out-of-band” frequency content, i.e., greater than f_{Max} but less than the Nyquist frequency, in digital processing. For example, a Fourier spectra estimate over the duration of the shock may display “general signal” to “noise” that seemingly contradicts the filter attenuation criterion displayed in Figure 516.8A-1a. In this case the signal conditioning system must be subject to the “verification of alias rejection” described in the paragraph to follow. If the signal conditioning system is verified as non-aliasing then the substantial frequency content between f_{Max} and the Nyquist frequency can be digitally filtered out if desired.

Verification of alias rejection should start by establishing the dynamic range within the pass band in terms of the signal to noise ratio (SNR). The voltage based $SNR = 20 \log_{10} (V_{FullScale} / V_{NoiseFloor})$ must be ≥ 60 dB. Once sufficient SNR is verified, establishing the alias rejection characteristics may be determined using an input sine wave with a magnitude of $0.5 * \text{full scale range}$ and at the lowest frequency range that can impinge i.e., be aliased into f_{Max} , and then confirming (using the IEEE 1057 sine wave test procedure or through inspection of the time domain data) that the alias rejection is sufficient at this frequency for the signal conditioning system.

For a conventional multi-bit ADC such as flash or successive approximation design, if a 100 thousand sample/second digitizing rate is used, for example, then $f_{Nyquist} = 50$ KHz. Theory says that if a signal above the Nyquist Ratio is present, it will “fold over” into a frequency below the Nyquist ratio. The equation is:

$F_a = \text{absolute value} [(F_s * n) - F]$, where

F_a = frequency of “alias”

F = frequency of input signal

F_s = sample rate

n = integer number of sample rate (F_s) closest to input signal frequency (F)

Hence, the lowest frequency range that can fold back into the 10 KHz passband is from 90 KHz to 110 KHz.

It should be noted that Sigma Delta (SD) digitizers “oversample” internally at a rate several times faster than the output data rate and that analog anti-alias filtering is still required. For illustrative purposes, consider an example for a SD digitizer with a bandwidth of interest up to 10 KHz that samples internally at $f_s = 800$ thousand samples/second. The internal analog based Nyquist frequency by definition is 400 KHz, hence the analog anti-alias filter should attenuate 50 dB or more content that can fold back into the 10 KHz pass band (790 KHz to 810 KHz and similar bands that are higher in frequency). Figure 516.8A-1b illustrates sampling frequencies, Nyquist frequencies, and frequency bands that can fold back into the bandwidth of interest for both conventional and over sampling digitizers, such as the Sigma Delta. Observe that for the example SD design, there is significant bandwidth above the 10 KHz desired f_{Max} and the Nyquist rate that is not useable due primarily to quantization error, an artifact of the single bit SD design. The output of a SD ADC will be digitally filtered and resampled yielding a new effective sampling rate f_{DR} which in turn yields a new Nyquist rate for the decimated signal of $f_{DR}/2$. Through careful selection the digital filter cutoff frequency, the majority of noise between $f_{DR}/2$ and f_s is removed while maintaining a nearly flat frequency response through f_{Max} . The SD oversampling rate $OSR = f_s / f_{DR}$, which is directly correlated to dynamic range, is one of several design parameters for a SD ADC. Most reputable vendors will provide a detailed specification sheet associated with their products, however, it is strongly recommended that one verifies aliasing rejection and noise floor characteristics as recommended above prior to employing any signal conditioning/digitizing system in the acquisition of critical field data.

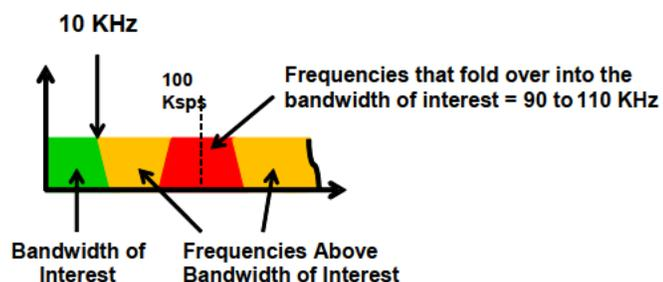
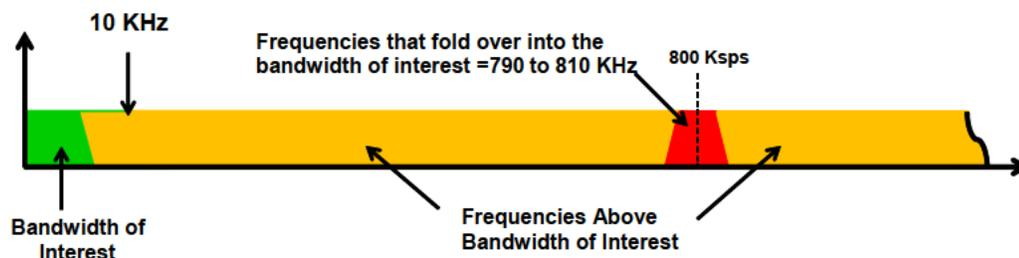
MIL-STD-810H
METHOD 516.8 ANNEX A**Conventional ADC (Flash, Successive Approximation, etc.)****Oversampling ADC (Sigma Delta, etc.)**

Figure 516.8A-1b Illustration of sampling rates and out of band “fold over” frequencies for Conventional and Oversampling (Sigma-Delta) based data acquisition systems.

1.2 Measurement Shock Identification

A “simple shock” is being addressed in this Method (excluding Procedure VIII and the example of a complex shock provided in Annex B), i.e., the impulse force input defines a single “event” arising from a characteristic phenomenon. A “simple shock” is defined by a measurement, e.g., acceleration, with three characteristic regions:

- a. An initial low amplitude stationary random measurement termed *the measurement system noise floor*.
- b. A series of erratic high amplitude decaying measurement amplitudes termed *the shock*.
- c. A comparatively low level stationary measurement at or just above the instrumentation noise floor termed *the post-shock noise floor*.

NOTE: If periodic components or non-Gaussian behavior are present in *the measurement system noise floor*, the signal conditioning system needs to be examined. If periodic components are present in *the post-shock noise floor* but the general amplitude is relatively stationary, it is indicative of mounting/materiel resonance response. A trained analyst needs to decide the importance of such resonance information in a laboratory test specification. This decision should be based upon the lowest mounted fundamental frequency of the materiel. In general, shock information should not be unduly extended in order to accommodate the full extent of the resonant “ringing” behavior.

It is always imperative that the data be carefully analyzed to ensure the measurement is free of corruption, and the nature of the event is physically well grounded. This subject is discussed in greater detail in Annex B.

MIL-STD-810H
METHOD 516.8 ANNEX A

The example that follows will illustrate initial time domain assessment of a typical transient acceleration time history. Annex B will provide frequency domain and more advanced assessment. Figure 516.8A-2 displays the measurement shock that will be considered for proper processing in both the time and frequency domain. The phenomenon producing the shock has initial high frequency/high energy input, followed by a form of ringing or resonance decay. The measurement shock exists between 617 milliseconds and 1560 milliseconds.

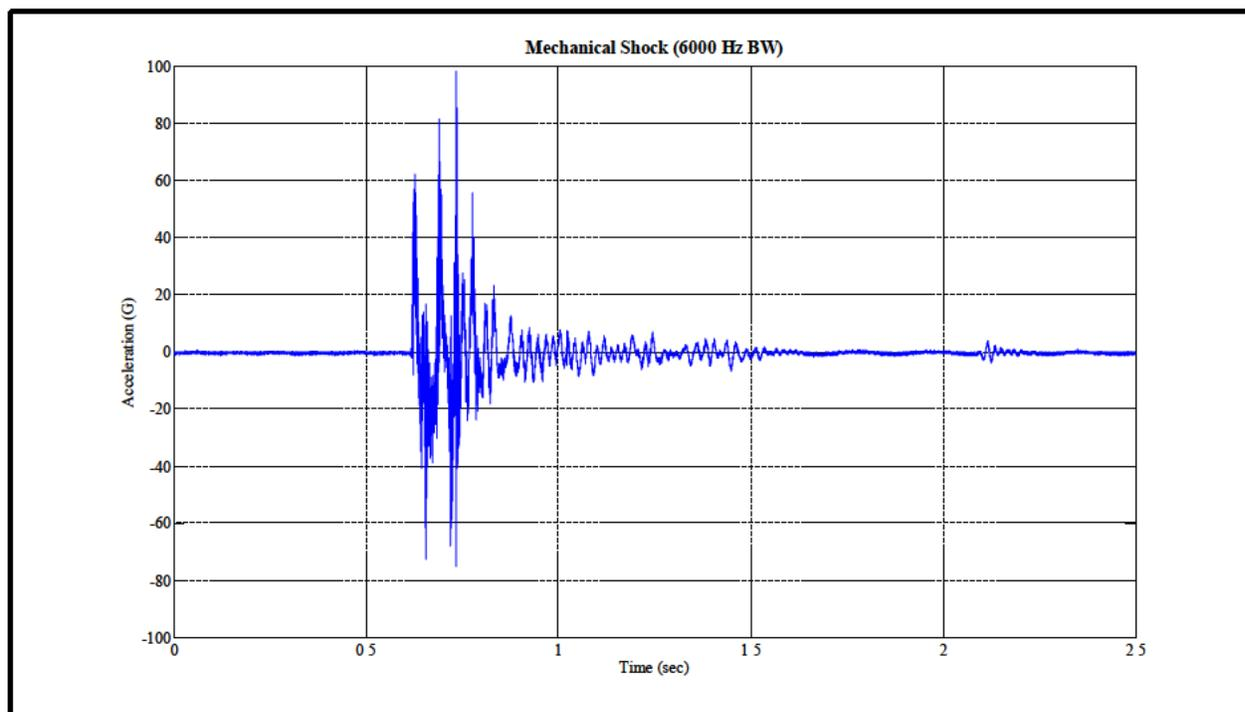


Figure 516.8A-2. Example acceleration time history.

1.3 Effective Pulse Duration for Non-Classical Shocks

When considering the two non-classical shock alternatives discussed in paragraph 1.2, the analyst (and ultimately test operator), will need to consider the effective durations (including the overall shock duration (T_e) and the concentration of energy duration (T_E)) for the pulse to be replicated. In the case in which TWR is selected as the implementation method, the duration of the transient event is straightforward. The test operator should simply identify the pre-pulse and post-pulse noise floor levels that will indicate reasonable start and end times for the TWR based event. In the case in which a reference transient is to be synthesized based upon an SRS reference, the SRS reference must come with recommended effective durations established by the analyst review of the data ensemble used to develop the SRS reference. The analyst may view the effective durations of a transient event from a number of perspectives. However, the final guidance on effective durations provided to the test operator with the reference SRS should be simplified to manageable parameters to which the test operator will be able to implement efficiently. Providing the test operator both the shock duration T_e and the concentration of energy duration T_E is recommended for any SRS based laboratory shock test. With the SRS magnitude controlling the synthesized pulse magnitude and both T_e and T_E defining energy distribution, the synthesized pulse should resemble a measured pulse having the same SRS. The concept of effective durations is discussed further in the following paragraphs. Annex B contains more information on determining T_e and T_E based upon easily computed “instantaneous root-mean-square” computations.

MIL-STD-810H
METHOD 516.8 ANNEX A

As mentioned in paragraph 1.2, a “simple shock” (refer to Figure 516.8A-3), is defined in terms of three time intervals:

a. The first time interval; T_{pre} is usually well defined and occurs prior to the shock where the measurement represents the *measurement system noise floor*.

b. The second interval; T_e is termed the *shock duration* and is defined as the duration from the zero crossing for the first measurement acceleration “above the instrumentation noise floor” until the perceived “termination” of the *shock*. This interval contains the interval with the highest concentration of energy, T_E , defined as the minimum length of time that contains any time history magnitudes exceeding in absolute value $\frac{|A_{pk}|}{CF}$ (see detailed discussion below).

c. The third time interval; T_{post} is the time from the “termination” of the *shock* until the measurement signal approaches or reaches levels of the *measurement system noise floor*. (In general, shocks over reasonable characterization/identification times seldom decay to the levels of the pre-shock noise floor.) This third time interval can be termed the *post-shock noise floor* that is above, but includes the *measurement system noise floor*.

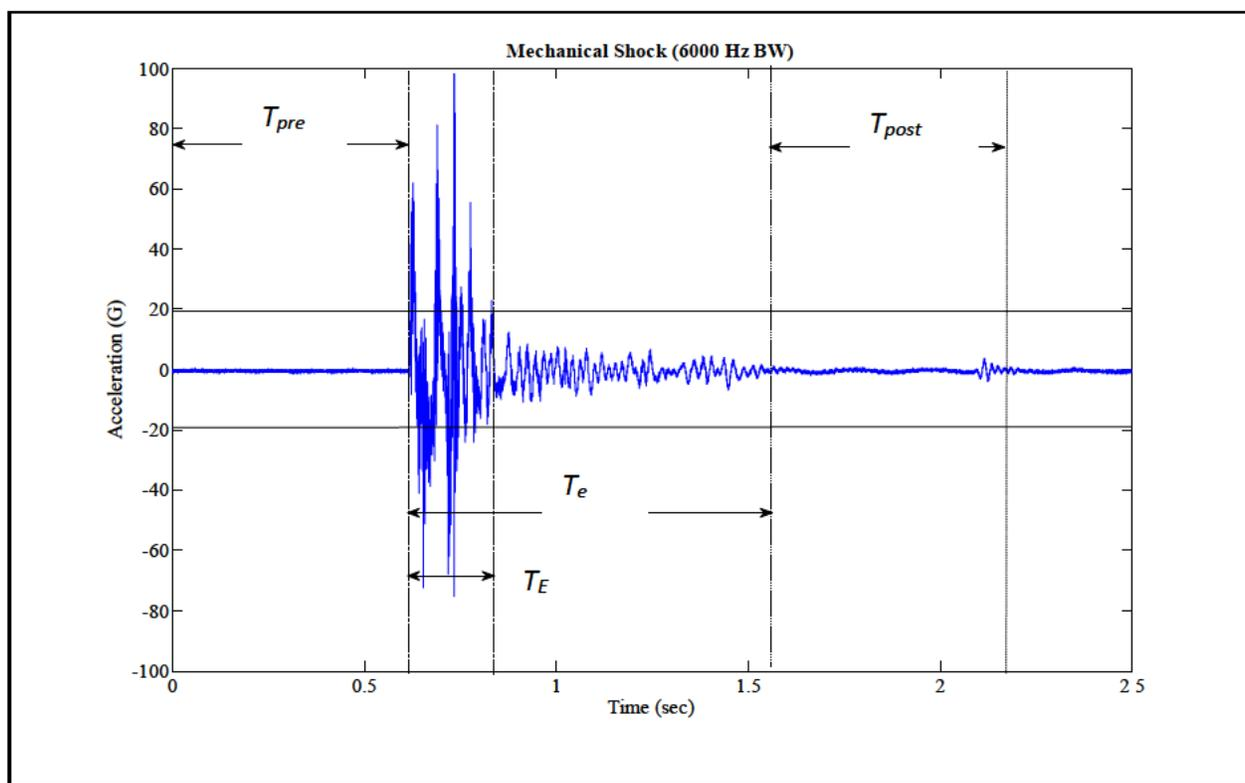


Figure 516.8A-3. Example simple shock time history with segment identification.

In general, for further processing it is convenient, if possible, to select the interval T_{pre} of duration equal to T_{post} and these intervals should be reasonably comparable or equal in length to T_e . The same amount of “time/amplitude” information is available in all three intervals.

MIL-STD-810H
METHOD 516.8 ANNEX A

1.3.1 Calculation of T_e .

There is historical precedence in which the shock duration T_e was defined as, “the minimum length of continuous time that contains the root-mean-square (RMS) time history amplitudes exceeding in value ten percent of the peak RMS amplitude associated with the shock event. The short-time averaging time for the unweighted RMS computation is assumed to be between ten and twenty percent of T_e .” The previous definitions also included discussion relative to the relationship between T_e and T_E at which point it was recognized that this relationship is dependent upon the “shape” of the true RMS of the time history. Although the previous definition of T_e is a useful analysis tool, T_e is now defined from the zero crossing for the first measurement acceleration “above the instrumentation noise floor” until the perceived “termination” of the shock as discussed above. This parameter provides a reasonable bound on the interval in which the reference time history contains measurable energy levels above the noise floor. In synthesizing the reference pulse for an SRS based laboratory test, the user should set the window length, (time-domain block size), containing the reference signal to T_e or the nearest programmable interval greater than T_e . Observe that unlike the field measurements, the noise floor of the synthesized signal will actually be zero. Zero padding outside of the interval T_e will have no effect on the SRS computation. In the event T_e (the shock duration) is not provided, define $T_e = \frac{2.5}{f_{\min}}$

where f_{\min} is the lowest frequency in the reference SRS (this will allow a minimum duration sufficient to allow up to 5 half-cycles of the lowest frequency component in the reference time history. T_e includes both the primary “concentration of energy” and an “extension of energy” duration.

1.3.2 Calculation of T_E .

T_E represents a “concentration of energy” duration. There is historical precedence in which T_E was defined to be the minimum length of time that contains any time history magnitudes exceeding in absolute value one-third of the shock peak magnitude absolute value, i.e., $\frac{|A_{pk}|}{3}$, associated with the reference time history. This assumes the shock peak amplitude, A_{pk} , has been validated, e.g., it is not an “instrumentation noise spike.” A definition of T_E that considers the crest factor, $CF = A_{pk}/RMS$, associated with the single shock or shock data ensemble from the reference SRS is defined. The crest factor is computed in small intervals over the duration T_e , (e.g. $T_e/10$), and the “maximum crest factor” computed on the individual intervals is defined as CF . This yields a revised definition of T_E based on the minimum length of time that contains any time history magnitudes exceeding in absolute value $\frac{|A_{pk}|}{CF}$. Even though the crest factor is a stationary random vibration concept applied when Gaussian or particularly non-Gaussian time histories are considered in stationary random vibration, it can be justified for use in terms of a shock if it is realized that peak amplitudes are of a random nature and come at random times. All amplitudes less than the last amplitude greater than $\frac{|A_{pk}|}{CF}$ define a time of *between* greater energy concentration and lesser energy concentration that can be quite robust. The analyst must however be immune from selecting a random amplitude spike time far from the major energy concentration, i.e., too strict an application of the concept for determining T_E . Generally, the larger the CF the greater T_E so selection of several CF 's and comparing T_E 's is recommended. For several shocks, i.e., an ensemble, varying CF and assembling a table of T_E 's should provide the analyst a robust method for establishing duration T_E for synthesis. Plots of CF versus T_E would indicate the sensitivity between the two variables. In the event T_e is not provided, the test operator should assume the CF to be 3, and synthesize a pulse such that T_E for the synthesized reference time history is characterized by T_E based on the minimum length of time that contains any time

MIL-STD-810H
METHOD 516.8 ANNEX A

history magnitudes exceeding in absolute value of $\frac{|A_{pk}|}{3}$. Having established a nominal value for T_E , the synthesis of a representative pulse shall have a tolerance of $0.8T_E \leq T_E \leq 1.2T_E$.

1.3.3 Implementation Considerations.

In summary, it is desired that the reference transient synthesized based upon an SRS reference has reasonably similar temporal characteristics to that of the field data from which the SRS reference was derived. The analyst developing SRS based test criteria should carefully investigate the effective duration of the ensemble of transient events from which the final test criteria was based, and document the results along with the SRS. The laboratory technician synthesizing the reference pulse should then be able to consider the variables, CF , T_e and T_E , associated with effective duration in the synthesis process. As an example, the above durations and associated time intervals are displayed for the typical simple shock in Figure 516.8A-3 where the pre-shock noise floor $T_{pre} \triangleq 0 \rightarrow 0.617 \text{ sec}$ and the post-shock noise floor is defined as $T_{post} \triangleq (T_{pre} + T_e)$ to $(T_{pre} + T_e) + T_{pre}$. T_{pre} and T_{post} were taken to be the same duration for processing comparison convenience. $T_e = 0.943 \text{ sec}$, is identified by the dashed lines between 0.617 and 1.56 seconds. The maximum crest factor, computed in intervals of $T_e/10$ was computed to be $CF \cong 5$. $|A_{pk}|/CF$ is identified by the horizontal lines based on $CF \cong 5$ and $|A_{pk}| = 98.17G$ (that occurred at time $T_{pk} = 0.735 \text{ sec}$). $T_E \cong 0.230 \text{ sec}$ is identified by the interval between the first occurrence of $|A_{pk}|/CF$ that occurs at approximately 0.625 seconds and the last occurrence of $|A_{pk}|/CF$ that occurs at approximately 0.860 seconds.

1.4 Shock Response Spectrum

The SRS, either acceleration maximax SRS estimates or the pseudo-velocity maximax SRS, is the primary “frequency domain” descriptor that links time history shock amplitudes to some physical model, i.e., the shock model. The below paragraphs will provide a description of the SRS options in addition to SRS estimates that may be used to imply the validity of the measured shock information.

1.4.1 Processing Guidelines

The maximax SRS value at a given undamped natural oscillator frequency, f_n , describes the maximum response (positive, negative, primary, and residual) of the mass of a damped single degree of freedom (SDOF) system at this frequency to a shock base input time history, e.g., acceleration, of duration T_e (see Figure 516.8-1 for the appropriate model). Damping of the SDOF is typically expressed in terms of a “Q” (quality factor). Common selections for Q are Q=50 that represents 1 percent critical damping; a Q =10 that represents 5 percent critical damping; and a Q=5 that represents 10 percent critical damping of the SDOF. For processing of shock response data, the absolute acceleration maximax SRS has become the primary analysis descriptor. In this description of the shock, the maximax acceleration values are plotted on the ordinate with the undamped natural frequency of the base input to the SDOF system plotted along the abscissa. The frequency range over which the SRS is computed, (i.e., natural frequencies of the SDOF system filters) as a minimum, includes the data signal conditioning bandwidth, but should also extend below and above this bandwidth. In general, the “SRS Natural Frequency Bandwidth” extends from an octave below the lowest frequency of interest, up to a frequency at which the “flat” portion of the SRS spectrum has been reached (that may require going an octave or more above the upper signal conditioning bandwidth). This latter SRS upper frequency $f_{SRS\max}$ requirement helps ensure no high frequency content in the spectrum is neglected, and is independent of the data bandwidth upper frequency, f_{\max} . As a minimum, this SRS upper frequency should exceed f_{\max} by at least ten percent, i.e., $1.1f_{\max}$. The lowest frequency of interest is determined by the frequency response characteristics of the mounted materiel under test. Define f_1 as the first mounted materiel natural frequency of the materiel (by definition, f_1 will be less than or equal to the first natural frequency of a materiel component such as a circuit board) and, for laboratory testing purposes, define the lowest frequency of interest as $f_{\min} < f_1/2$, (i.e., f_{\min} is at least one octave below f_1). $f_{SRS\min}$ can then be taken as f_{\min} . The maximax SRS is to be computed over the time range T_e and over the frequency

MIL-STD-810H
METHOD 516.8 ANNEX A

range from f_{\min} to $f_{SRS\max} > 1.1f_{\max}$. From paragraph 1.1 above, the f_{\max} relationship to f_{AA} is defined, however for SRS computation, if $F_s < 10f_{SRS\max}$ the time history must be re-sampled to $F_{S_r} > 10f_{SRS\max}$. The SRS frequency spacing in $[f_{\min}, 1.1f_{\max}]$ is left to the discretion of the analyst, but should not be coarser than one-twelfth octave and, in general, of a proportional band spacing as opposed to a fixed band spacing (proportional band spacing is more in tune with the materiel modal frequency spacing, and results in fewer natural frequencies for processing).

A more complete description of the shock (potentially more useful for shock damage assessment) can be obtained by determining the maximax pseudo-velocity response spectrum. The maximax pseudo-velocity may be plotted on log-log paper with the abscissa as SDOF natural frequency, and the ordinate as pseudo-velocity in units of velocity. Alternatively, a more complete description of the shock (potentially more useful for shock damage assessment) can be obtained by determining the maximax pseudo-velocity response spectrum, and plotting this on four-coordinate paper where, in pairs of orthogonal axes, the maximax pseudo-velocity response spectrum is represented by the ordinate, with the undamped natural frequency being the abscissa, and the maximax absolute acceleration along with maximax pseudo-displacement plotted in a pair of orthogonal axes, all plots having the same abscissa (SDOF natural frequency). This form of a pseudo-velocity SRS plot, as seen in Figure 516.8A-4, is widely accepted in Civil Engineering earthquake ground motion specifications, but historically has not been as common for mechanical shock display or specification.

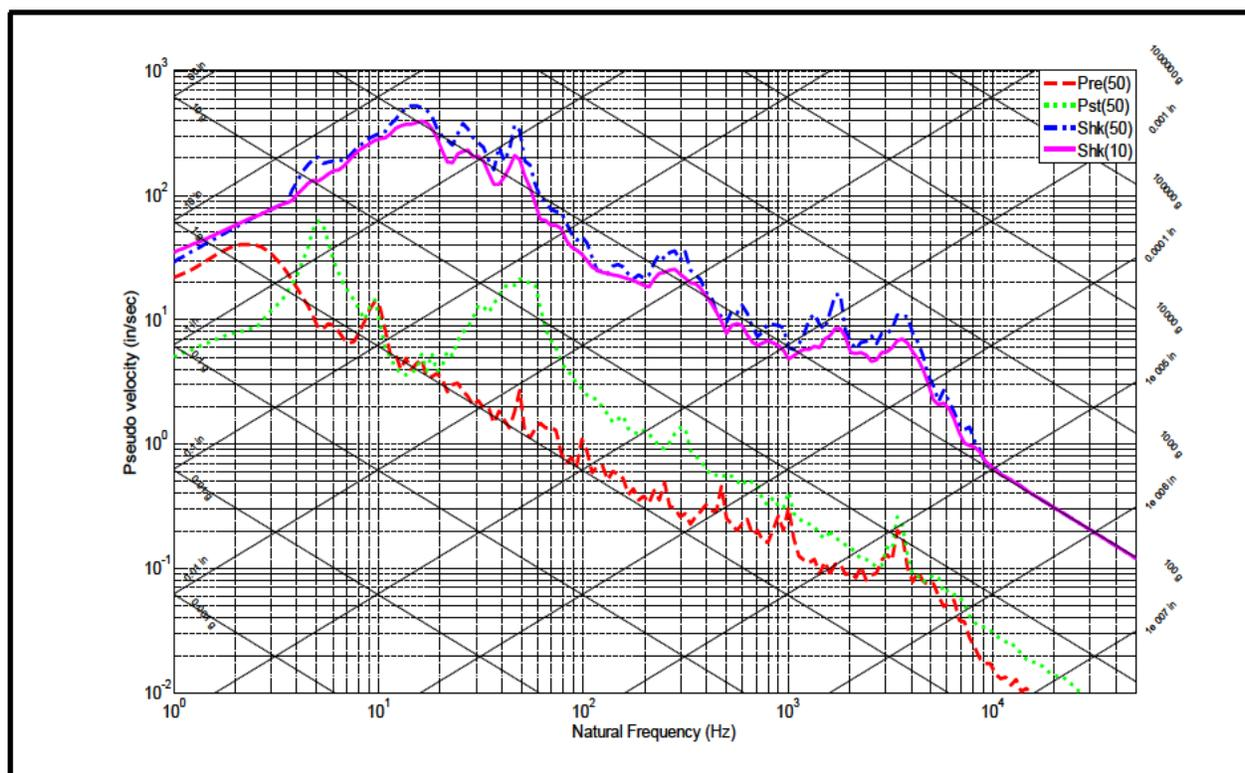


Figure 516.8A-4. Maximax pseudo-velocity SRS estimates for shock and noise floor segments.

The maximax pseudo-velocity at a particular SDOF undamped natural frequency is thought to be more representative of the damage potential for a shock since it correlates with stress and strain in the elements of a single degree of freedom system (paragraph 7.1, references e and f). In the laboratory testing to meet a given specification with undesignated Q, use a Q value of 10 and a second Q value of 50 for comparison in the processing (see Figure 516.8A-4). Using two Q values, a damped value and a value corresponding to light damping provides an analyst with information on the potential spread of maximum materiel response. Recommend the maximax absolute acceleration SRS be the primary method of display for the shock, with the maximax pseudo-velocity SRS the secondary method

MIL-STD-810H
METHOD 516.8 ANNEX A

of display. This is useful in cases in which it is desirable to be able to correlate damage of simple systems with the shock. Two additional recommendations related to the validity of the measurement are as follows:

a. A pre-shock SRS of the measurement system noise floor over interval T_{pre} should be computed along with the return to noise floor interval T_{post} , i.e., post-shock noise floor, and displayed on the same plot. These noise SRSs help to confirm the overall validity of the measurement if the “Pre” and “Post” times allow adequate accuracy for the SRS estimates, i.e., SRS estimates over very short time segments may not provide representative maximax SRS amplitudes at low natural frequencies. These SRS estimates should be computed at the $Q=50$ damping value (see Figure 516.8A-4). Refer to Annex B, paragraph 3 for additional guidance on establishing criteria for defining the noise floor.

b. For the shock segment, both the maximum positive and maximum negative acceleration and pseudo-velocity SRS estimates should be plotted for a minimum Q value of 10 over the frequency range for which the shock SRS values are displayed (see Figure 516.8A-5). The positive and negative SRS estimates should be very similar in nature as discussed in paragraph 1.4.2 and illustrated through example in Figures 516.8A-5&6. The low Q value should be able to detect acceleration time history anomalies similar to the time history integration. If positive and negative SRS maximax values are disparate, this could be an indicator of potential measurement system signal conditioning problems.

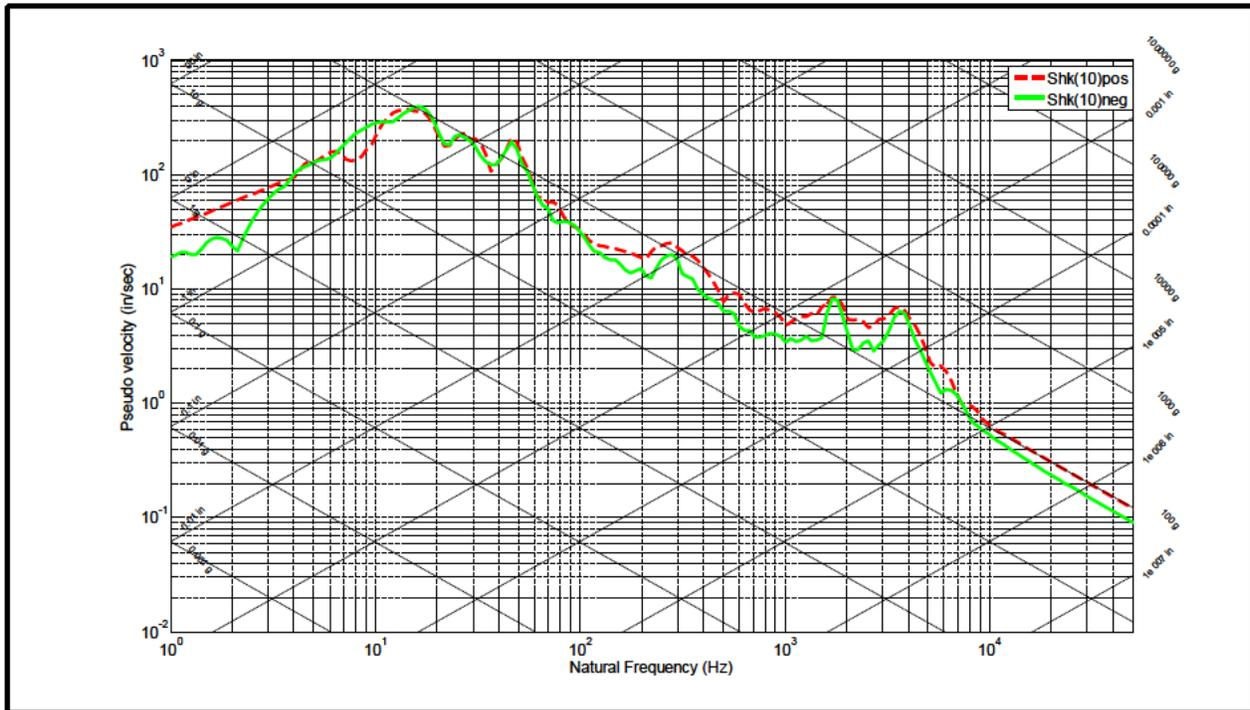


Figure 516.8A-5. Shock maximum and minimum pseudo-velocity SRS estimates.

MIL-STD-810H
METHOD 516.8 ANNEX A

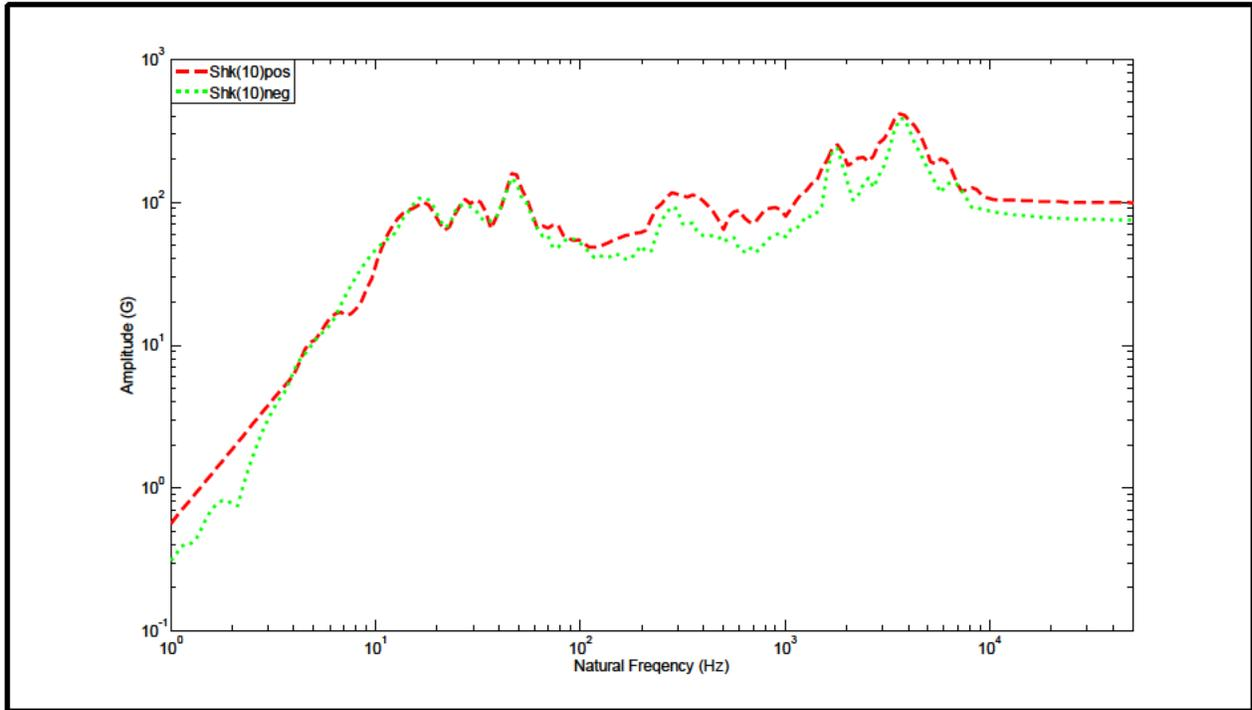


Figure 516.8A-6. Shock maximum and minimum acceleration SRS estimates.

1.4.2 Processing Example

For the shock time history displayed in Figure 516.8A-3, the sample rate was 51200 samples per second. The bandwidth of the data was from DC to 6000 Hz. The bandwidth of interest was from 10 Hz to 6000 Hz. The time history was re-sampled to 102,400 Hz to ensure a reasonable SRS computation thru 10 KHz as discussed in paragraph 1.4.1. The SRS estimates are actually plotted to 50 KHz to illustrate convergence at the low and high frequency extremes. Since even the slightest of bias error influences velocity estimates computed from acceleration data, it is recommended that minor DC bias should be corrected as required prior to performing pseudo velocity calculations (a severe bias error in the acceleration time may indicate more serious issues such as amplifier and/or transducer saturation leading to data validity concerns). Quality factors of 10 and 50 were used for computation of the acceleration and pseudo-velocity maximax SRS estimates except where noted. Except where noted, the computations were made with the standard ramp-invariant filter set. The abscissa of the plots is the undamped natural frequency of the SDOF system at a one-twelfth-octave band spacing.

Figure 516.8A-7 contrasts the *shock* maximax acceleration SRS for the Q values of 10 and 50, and for both *measurement system noise floor* and *post-shock noise floor* for a Q of 50. Figure 516.8A-4 provides the related information for the maximax pseudo-velocity SRS estimates. As expected, the shock is substantially greater than either noise floor SRS estimates. Ideally, the noise floor SRS should be 12dB or more below the acceleration SRS of the shock event across the frequency range of interest.

MIL-STD-810H
METHOD 516.8 ANNEX A

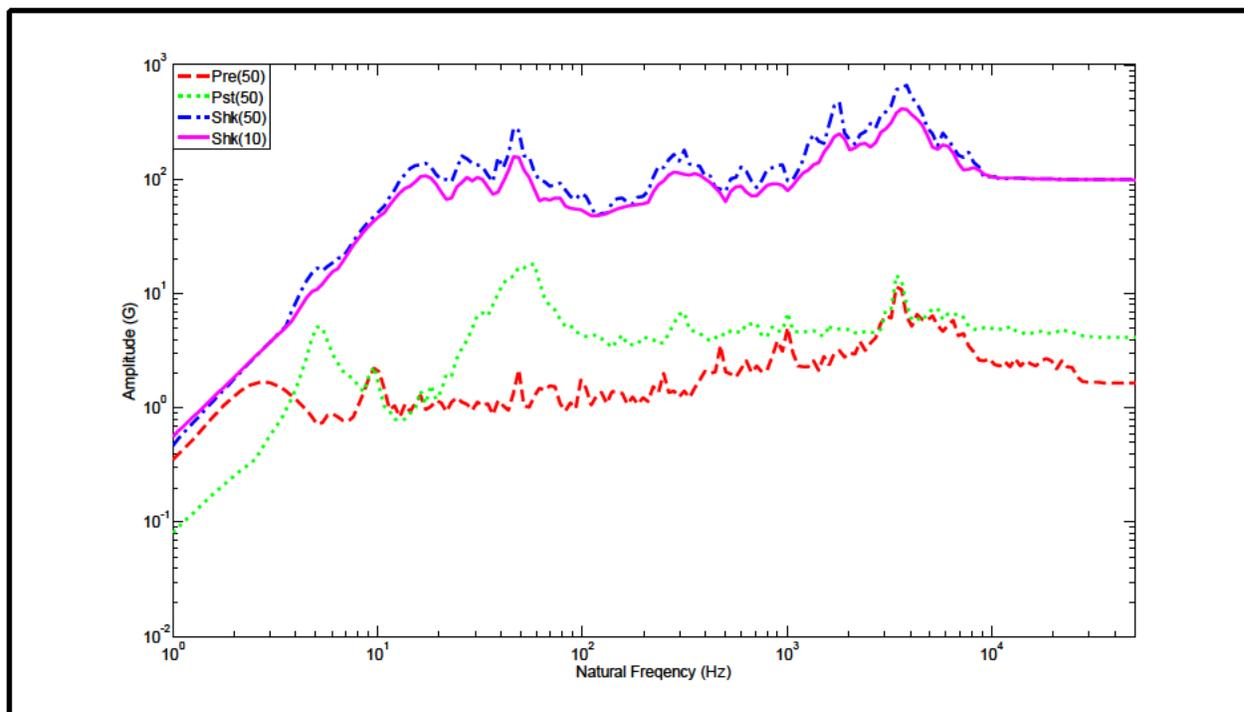


Figure 516.8A-7. Maximax acceleration SRS estimates for shock and noise floor segments.

As a time history validity check, Figure 516.8A-5 and Figure 516.8A-6 provides the positive and negative SRS estimates. It is noted that in these two figures neither the positive nor negative SRS value dominates the other; that would imply the time history information is valid.

1.5 Frequency Domain Identification Energy Spectral Density (ESD)

The ESD estimate is a properly scaled squared magnitude of the Fourier Transform of the total shock. Its counterpart, the Fourier Spectra (FS) is, in effect, the square root of the ESD, and may be useful for display but will not be discussed here. The importance of the ESD estimate is its properties relative to input/output system computations. That is for two acceleration measurements related as input and output, either (1) an estimate of the transfer function (magnitude/phase) between the input and output is possible, or (2) a transmissibility estimate (magnitude alone) can be determined by ratioing the output ESD over the input ESD. Further details and illustration of ESD estimates are provided in Annex B.

1.6 Single Event / Multiple Channel Measurement Processing Guidelines

When multiple measurements are made for a single configuration, generally pre-processing should proceed as if multiple channel analysis is to be performed. In particular, the pre-shock noise floor, the shock event, and the post-shock noise floor should be of the same duration, and this duration for the shock event should be determined based upon the “longest” duration measurement. Since SRS and ESD processing are generally insensitive to differences in the duration of significant energy content, such selection will allow multi-channel processing. It is imperative that for cross-energy spectral density estimates and energy transfer function estimates, the pre-processing, e.g., event selection durations, filtering, etc., on all measurement channels be the same. Pre-processing across multiple measurement channels involving integration of acceleration to determine velocity needs to correspond to the physics of the configuration. For high signal-to-noise ratios, useful information can be obtained from cross-spectral and transfer function estimates even though random error is high.

1.7 Measurement Probabilistic / Statistical Summary

Recommend that, whenever possible, two or more equivalently processed response measurements or test estimates be combined in some statistical manner for summary. This summary then can be used for test specification purposes to provide a level of confidence that the important information in the measurement or test has been captured. Paragraph 7.1, reference b, discusses some options in statistically summarizing processed results from a series of measurements

MIL-STD-810H
METHOD 516.8 ANNEX A

or tests. The best summary option is generally dependent on the size of sample. Processed results from the SRS or ESD are typically logarithmically transformed to provide estimates that tend to be more normally distributed, e.g., estimates in dB. This transformation is important since often very few estimates are available from a test series, and the probability distribution of the untransformed estimates cannot be assumed to be normally distributed. In virtually all cases, combination of processed results will fall under the category of small sample statistics, and need to be considered with care with other parametric or less powerful nonparametric methods of statistical analysis. Annex C addresses the appropriate techniques for the statistical combination of processed test results as a function of the size of the sample and provides an example.

1.8. Other Processing

Other descriptive processes that tend to decompose the shock into component parts, e.g., product model, time domain moments (TDM), wavelets, SRS modal and power energy methods (PEM), etc., may be useful, but details of such descriptive processes are beyond the scope of this document, and generally fall in the area of analytical modeling. TDM and PEM show promise of being able to characterize and compare individual shocks among sets of similar shock time traces and perhaps provide insight into cause of materiel failure from shock. TDM (paragraph 7.1, reference k) assessment provides for characterization of the “form” of measured response with respect to both time and frequency. PEM (paragraph 7.1, reference l) attempts to estimate the energy absorbed within a simple modal structure of the materiel when the materiel’s base attachment is the source of the shock input (or power input) to the materiel. PEM seems most useful for power comparison among similar measurements for shock, and has units (force*velocity) that relate to damage potential when applied to base motion relative to mass motion.

MIL-STD-810H
METHOD 516.8 ANNEX B**METHOD 516.8, ANNEX B****GUIDELINES FOR ADDITIONAL SHOCK TIME HISTORY VALIDATION AND PROCESSING****1. INTRODUCTION.**

This Annex provides additional guidelines for shock time history assessment including validation, i.e., to detect any measurement system anomalies that would invalidate the measurement. For massive field shock measurement programs where time and budget constraints do not allow validation of individual shocks, at least one shock time history from each measurement channel needs to be individually validated, and careful examination of the time history for each subsequent shock from the measurement channel be examined for gross anomalies. Consistency relative to the test specification for processed information is acceptable as long as any inconsistency is investigated under shock time history validation. For example, the Normal Tolerance Limit (Annex C) when properly applied should be used only for collections of SRS estimates that have a similar shape; otherwise the variance is inflated beyond what might exist for field measured data under repeated experimental measurements.

2. COMPLEX SHOCKS.

This Method and this Annex are focused upon simple shocks such as in Figure 516.8-A1 (and repeated below as Figure 516.8B-1). Many shocks are not simple in nature. Figure 516.8B-2 displays a complex shock. The phenomenon producing this shock would appear to have three “rebounds.” If it can be traced to a distinct phenomenon, the last of the four shocks might be separated out as a simple shock from the other three. A trained analyst and a clear understanding of the shock producing phenomenon are needed to justify any such decomposition of this complex shock. It probably would not be possible to use SRS synthesis for laboratory test, leaving TWR as the only option for laboratory testing. Cases in which it would appear that several “simple shocks” are in series should rely upon a trained analyst to identify individual “simple shocks” in concert with goals of the characterization, analysis, and specification. Any decomposition of a series of shocks should be related to the phenomenon producing the shock. For example, a catapult shock represents a non-simple shock that could be specified as two independent simple shocks, separated in time by approximately three seconds with an intervening transient vibration. See Figure 516.8-11. Gunfire Shock, Method 519.8, presents information on a repeated shock, the repetition rate being the gun-firing rate. The direct replication method is preferred over the synthesis method when non-simple shocks are being considered.

Generally, this Method has no recommendations beyond the use of TWR for laboratory test specification and laboratory testing for such complex shocks. It is important to maintain the integrity of the complex shock to the extent possible.

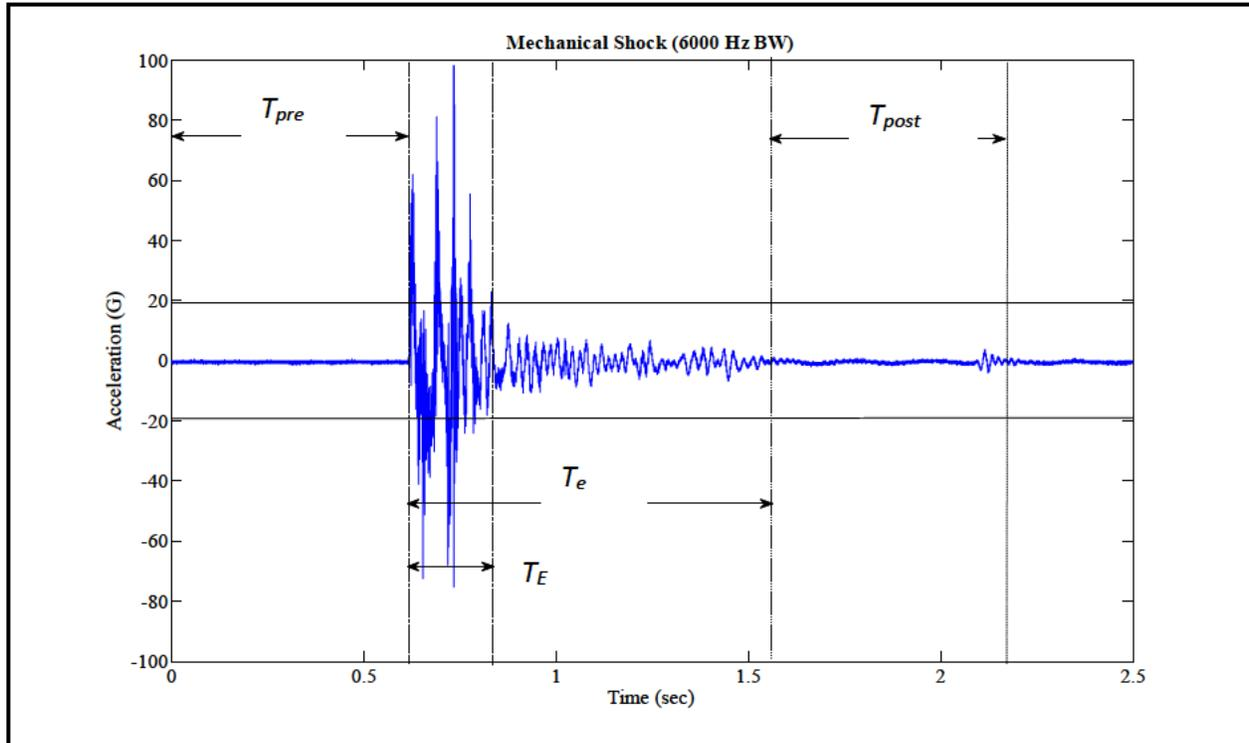
MIL-STD-810H
METHOD 516.8 ANNEX B

Figure 516.8B-1. Shock time history with segment identification and T_e and T_E time intervals illustrated.

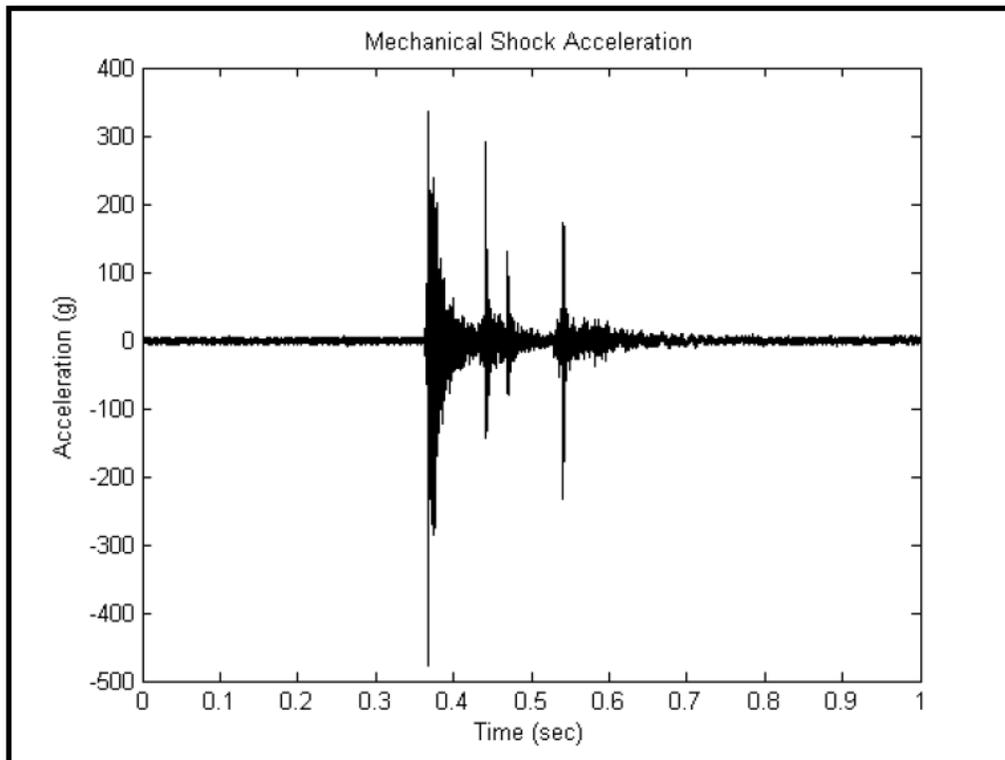


Figure 516.8B-2. A complex shock.

MIL-STD-810H
METHOD 516.8 ANNEX B

3. ADDITIONAL SIMPLE SHOCK PROCESSING AND VALIDATION.

3.1 Introduction.

In Annex A paragraph 1.3 of this method, the simple shock time segment for the instrumentation noise floor, the shock and the post shock noise floor are identified. In addition T_e and T_E are specified. Since the SRS is the primary analysis descriptor, both maximax acceleration and maximax pseudo-velocity estimates of the segments are displayed and interpreted. For verification purposes, the shock maximax positive and negative SRS estimates are displayed. Comparability of these estimates showed no signs of the shock being invalid. In this paragraph the following analysis will be undertaken providing (1) additional analysis of the shock, and (2) additional information regarding the validity of the shock. In particular:

- a. The time history instantaneous root-mean-square.
- b. The shock velocity and displacement displayed.
- c. The time history ESD estimate displayed.

Annex A paragraphs 1.7-1.8 of this Method reference more advanced processing that is applicable to a single simple shock or useful in summarizing the information in an ensemble of shocks. No such advanced processing is provided in this Method.

3.2 Instantaneous Root-Mean-Square (RMS).

The “instantaneous rms” provides useful information that may not be apparent from examining the amplitude time history. In order to establish shock time intervals for processing, it is useful to consider the “*instantaneous rms*” of a measurement level. For the measurement $a(t)$ $0 \leq t \leq T$, the *instantaneous rms* level is defined over the same interval as follows: $a_{irms}(t) = \sqrt{a^2(t)} \geq 0$ for $0 \leq t \leq T$, where “irms” stands for “*instantaneous root-mean-square level*”. It is assumed that any DC offset in a digitized measurement signal, $a(t)$, has been removed prior to computing a_{irms} . Figure 516.8B-3 displays the irms in absolute terms and in dB. In the dB display, no negative values are displayed. Observe that a_{irms} is computed point by point. Therefore, $|A_{pk}|$ as referenced in paragraph 1.3 in Annex A of this method, will be the maximum computed a_{irms} .

From the example of Figure 516.8B-3, it is clear that the “signal” approaches 40 dB, while the “noise floor” is on the order of 3 dB, roughly a signal-to-noise ratio of 37 dB. Relative to identifying the time of the beginning of the *post-shock noise floor*, T_{Post} , it is a matter for an experienced analyst in concert with the objectives of the shock assessment. Almost assuredly, post-shock instantaneous rms is greater than the pre-shock instantaneous rms, i.e., $a_{irms}(T_{Post}) > a_{irms}(t)$ for $t \leq T_{Pre}$ since the measurement seldom returns to the *measurement system noise floor* levels because of change of boundary conditions as a result of the shock. If there is indication of periodic behavior in the time trace for $t > T_{Pk}$, the analyst must decide if analysis over this periodic “ringing” behavior is important for the shock specification. For SRS shock synthesis, it will be difficult to capture such periodic behavior and duplicate it in testing. For waveform replication, this periodic “ringing” behavior should be retained over a minimum of ten cycles if possible. For establishing the end of the range of T_e for a simple “well-behaved,” i.e., sharply decaying shocks, it is recommended that the analyst examine times t at which $a_{irms}(t)$ for $t > T_{Pk}$ is at least 20dB (preferably 40 dB) below $a_{irms}(T_{Pk})$, and based upon judgment, select the zero-crossing for defining the end of beginning of T_e (or beginning of T_{Post}). Generally, criteria for defining and automatically determining T_{Post} are left to the discretion of the analyst, and selection of T_{Post} is much more inconsequential in analysis than selection of T_{Pre} . An estimate of the *measurement system noise floor* level will be useful in establishing T_{Post} . If arbitrary specification of $a_{irms}(t)$ levels is not feasible, then a relatively robust way of specifying the end of a *shock* and the beginning of the *post-shock noise floor* is to begin at the end of the measured data, T , and compute the mean rms signal level until a noticeable change in level is apparent. This can be accomplished by selecting an averaging time, e.g., ~5 percent of the estimated duration of the *shock*, and computing a moving average of time history values in the *measurement system noise floor* and *post-shock noise floor*, where the average is shifted at least ten times within an averaging time window and ideally

MIL-STD-810H
METHOD 516.8 ANNEX B

computing the average at each time point. Usually, plotting these rms levels leads to simple identification of T_{Post} . Specifying the normalized random error for the rms estimate can enhance this procedure.

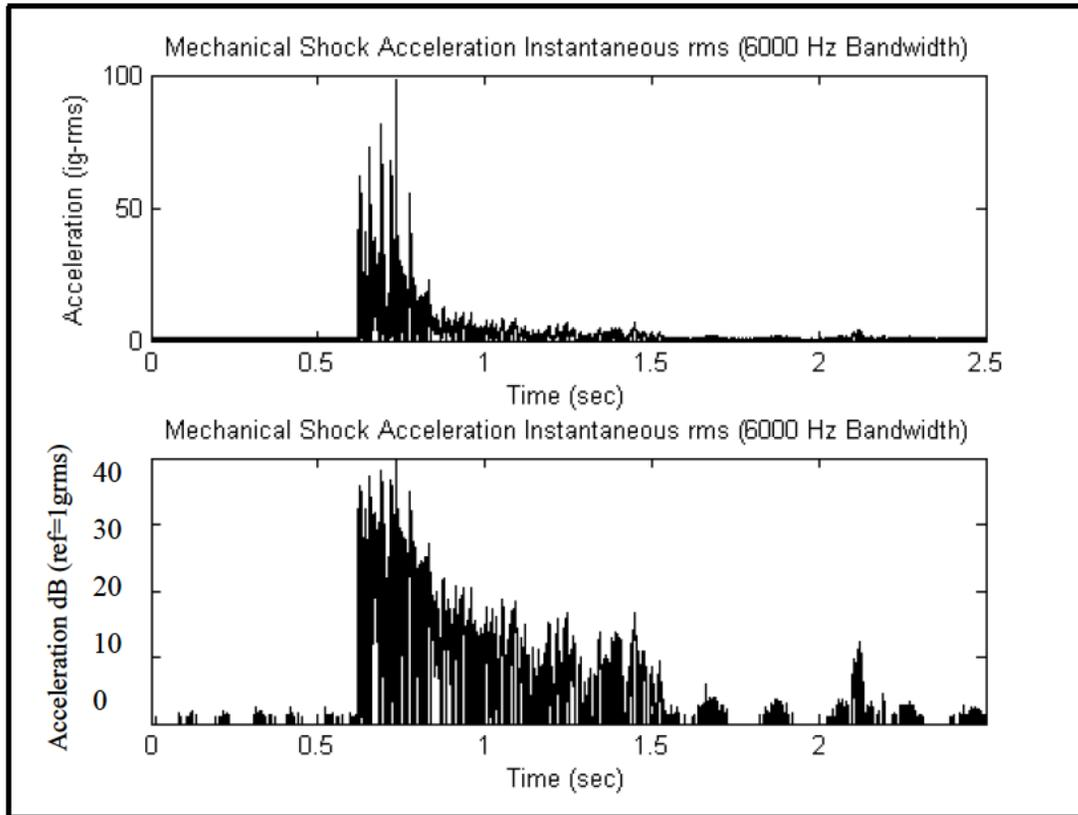


Figure 516.8B-3. Shock time history instantaneous root-mean-square.

This error is given by $\varepsilon_r = 1/2\sqrt{BT}$ for B the bandwidth and T the averaging time. A 95 percent confidence interval is defined by $[\hat{\sigma}_x(1-2\varepsilon_r) \leq \sigma_x \leq \hat{\sigma}_x(1+2\varepsilon_r)]$. For $\varepsilon \approx 0.025$, then $[0.95\hat{\sigma}_x \leq \sigma_x \leq 1.05\hat{\sigma}_x]$. Estimating both the *measurement system noise floor* and *post-shock noise floor* levels (standard deviations) for a specified normalized random error, e.g., 0.025, computing the 95 percent confidence intervals and determining the degree of overlap of the *measurement system noise floor* and *post-shock noise floor* confidence intervals can provide an analytical criterion for specifying the end of a shock. Excessive noise that may not be Gaussian in form in the *post-shock noise floor* may be an indication of a degraded instrumentation signal conditioning system as a result of the shock, e.g., broken accelerometer sensing element, amplifier slew rate exceeded, etc. In this case, the post-shock integrity of the measurement system needs to be validated (see paragraph 4 below).

If such computation and subsequent displays are not available, the assessment for the end of the shock, and beginning of the post-shock noise floor can be determined based on examination of a representative sample of the positive and negative peaks in the time history (usually starting from the end of the measurement and avoiding single spurious “noise spikes”) without regard to sign. In this case, the maximum peak (positive or negative) can be estimated in absolute units, and then a -20 dB, -30 dB, and -40 dB level down from the validated peak A_{pk} , estimated by $-y = 20 \log_{10} \left(\frac{A_{pk}}{|A|} \right)$ for y the desired dB decrement, and A representing either a positive or negative peak.

Because of the need to balance the normalized random error with the normalized bias error to determine optimum averaging times, it is not recommended that the instantaneous rms values be smoothed through short-time-averaging.

MIL-STD-810H
METHOD 516.8 ANNEX B

3.3 Shock Velocity/Displacement Validation Criteria.

Two steps are necessary for examining an unprocessed acceleration time history for purposes of validation.

- a. The first step is to clearly define the bandwidth of the measurement time history. The signal conditioning configuration and the ESD estimate to be discussed in paragraph 3.4 (below) will be helpful. The time history bandwidth will determine if TWR is a laboratory test option.
- b. The second step relates to integration of the time history to see if the velocity and displacement make physical sense. Velocity can usually be determined from direct integration of the shock acceleration after the shock has had its mean removed (velocity begins at zero and ends at zero), or has been high pass filtered to remove any DC component and other very low frequency information. Subsequent removal of the velocity mean or DC information in the velocity allows integration of the velocity to get displacement. As a minimum requirement, shock acceleration time traces should be integrated to provide velocity, and the velocity should have a clear physical interpretation, e.g., oscillatory behavior and near zero velocity at the “beginning” and the “end” of the shock. Velocity tends to be quite sensitive to sensor or signal conditioning anomalies that invalidate measurements. Integration of the velocity to obtain displacement should be considered an extended requirement, and reasonable values for displacement should be apparent. The *form* of velocity (or displacement) with respect to oscillatory behavior needs to be examined for reasonableness. That is, a *form* of velocity that displays little oscillatory behavior should be suspect. Figure 516.8B-4 displays velocity computed via mean removal alone. Figure 516.8B-5 displays the results of integrating velocity to arrive at displacement. For displacement, “DC” removal was performed on the velocity time history. Examination of both these plots, knowing the physical nature of the test, shows (1) reasonableness of peak amplitudes, and range from positive to negative values, (2) distinct and substantial oscillatory behavior during the “shock,” and (3) characteristic pre- and post- shock noise floor behavior. It would appear that the bandlimited measurement does not have readily identifiable anomalies, and the acceleration time trace can be considered valid for further processing that is designed to either support or refute this validation.

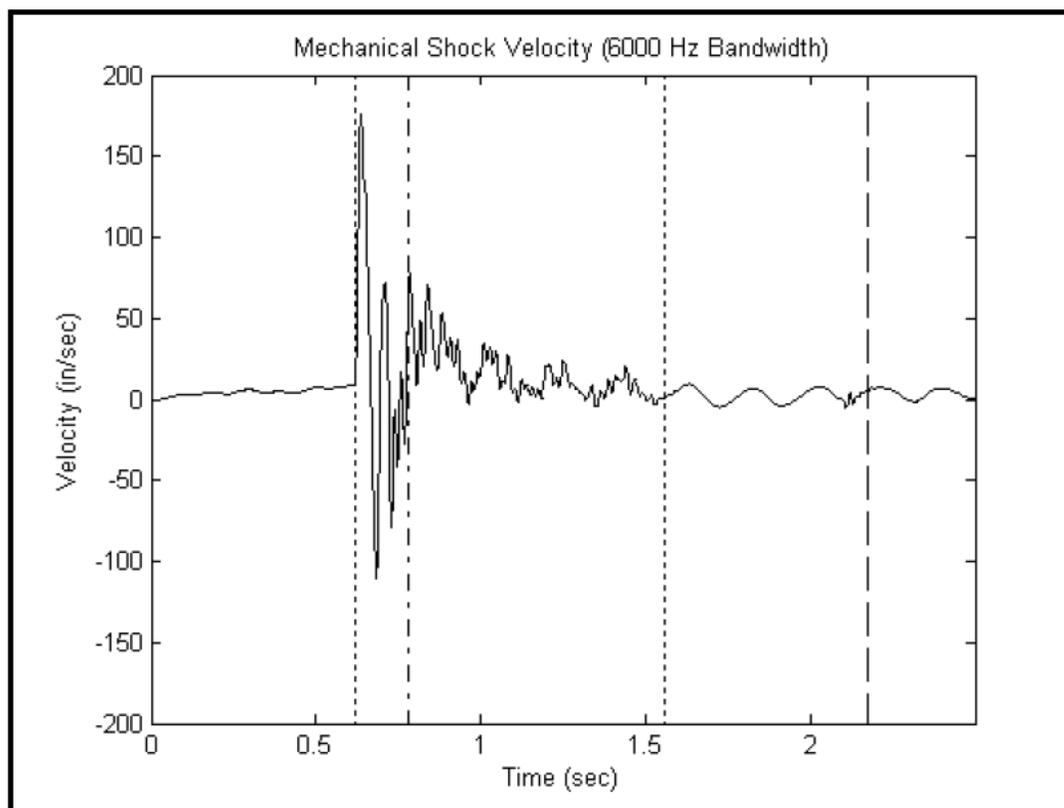


Figure 516.8B-4. Measurement velocity via integration of mean (DC) removed acceleration.

MIL-STD-810H
METHOD 516.8 ANNEX B

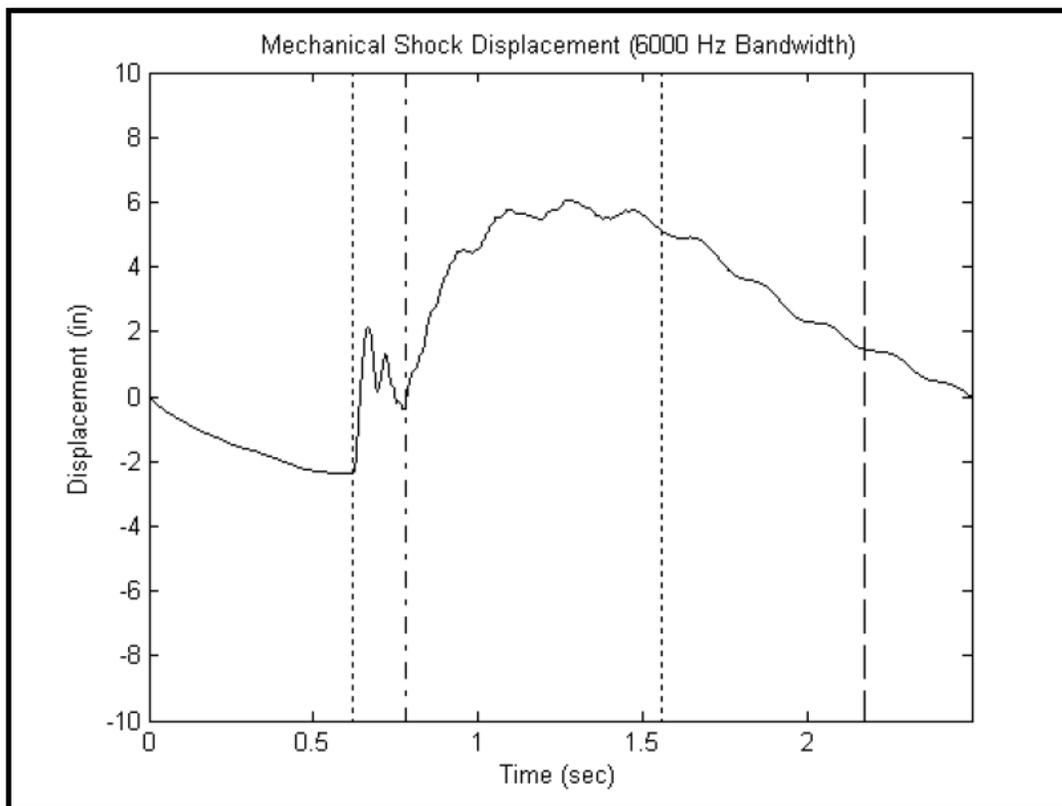


Figure 516.8B-5. Measurement displacement via integration of velocity after mean (DC) removal.

At this point in the analysis, if the velocity and displacement validation checks, particularly the velocity validation check, do not seem to correspond with the physics of the test, a detailed investigation of the reason for this discrepancy must be instigated. For example, velocities that are not physically realizable call for such an investigation. For one of a kind and expensive tests, it may be possible to recover meaningful data based upon advanced processing techniques.

3.4 ESD Estimate.

The ESD is a single block periodiogram sampled at a uniform set of frequencies distributed over the bandwidth of interest, and displayed as a two-dimensional plot of amplitude units ("units² - sec/Hz") versus frequency in Hz. In determining the estimate, the Fast Fourier Transform block size must include the entire shock above the measurement system noise floor, interval T_e , otherwise the low frequency components will be biased. Selection of an analysis filter bandwidth may require padding with zeros beyond the effective duration, T_e . Zero padding results in a frequency interpolation of the ESD estimate. Generally, a rectangular window will be assumed in the time domain, however, other windows are permissible, e.g., Kaiser, as long as the analyst understands the effects of the window shape in the frequency domain, since time domain multiplication results in frequency domain convolution. The ESD description is useful for comparing the distribution of energy within selected frequency bands among several shocks, provided the analysis frequency bandwidth is the same, and it is realized that the estimates have approximately 100% normalized random error. Figure 516.8B-6 displays the ESD estimate for the shock time history in Figure 516.8B-1. By either (1) averaging n adjacent ESD ordinates (keeping estimate bias a minimum), or (2) averaging n independent, but statistically equivalent ESD estimates, the percentage of normalized random error can be decreased by a factor of $1/\sqrt{n}$. Frequency averaging for periodiogram estimates is well defined in reference 6.1j. ESD estimates for noise floor segments tend not to be particularly useful for examining the validity of the measurement system because of the nondescript behavior of the noise floor.

MIL-STD-810H
METHOD 516.8 ANNEX B

For validation purposes, the ESD estimate should display proper frequency domain characteristics. In particular, the DC region should be rolled-off if the DC time history component has been removed, and the maximum bandwidth levels should be rolled-off if aliasing is not present. If the maximum bandwidth levels show an increase, it is quite possible that aliasing is present provided the time history has not been previously filtered. An ESD estimate needs to be computed on a high-passed time history that has been not bandlimited by digital filtering in any way.

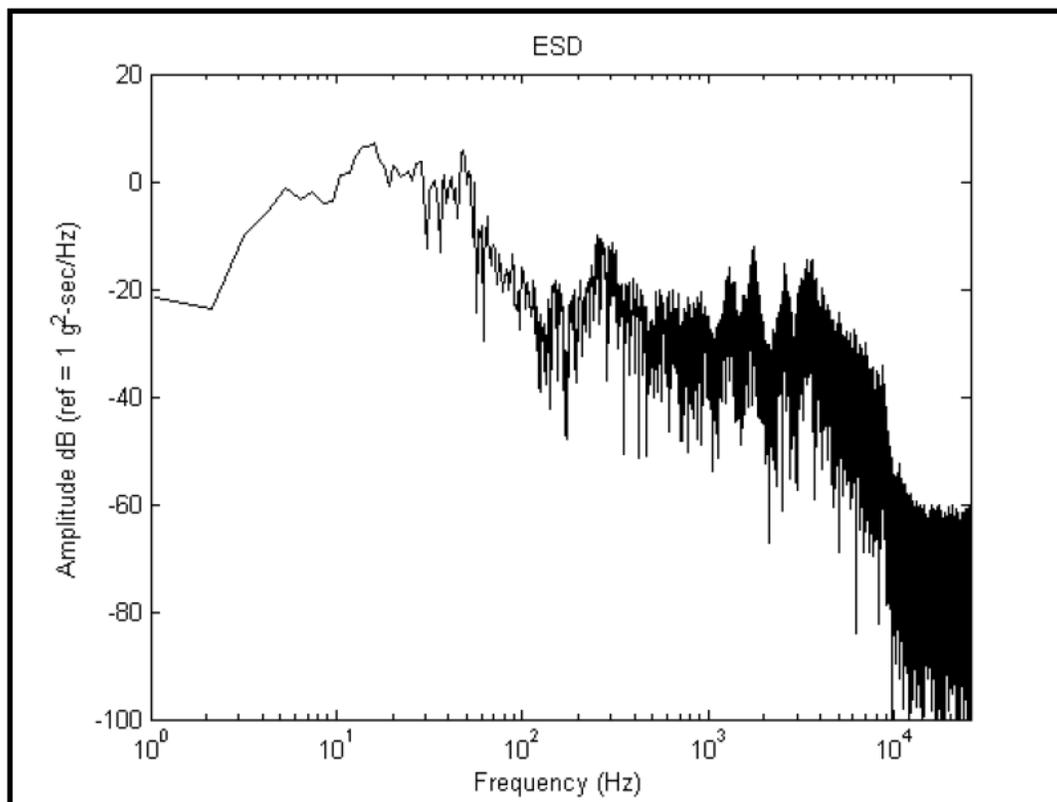


Figure 516.8B-6. Shock ESD estimate.

4. SHOCK IDENTIFICATION AND ANOMALOUS MEASUREMENT BEHAVIOR.

In the course of examination of some 216 mechanical shocks from a single test series (reference paragraph 6.1.c) the variation in time history form is substantial, and requires the judgment of an analyst for development of a specification for which shock synthesis for an electrodynamic exciter might be appropriate. Figures 516.8B-7 through 9 display typical anomalous time histories related to signal conditioning or transducer problems. The identification of the problem is assumed, and generally based upon a visual examination of the time history.

MIL-STD-810H
METHOD 516.8 ANNEX B

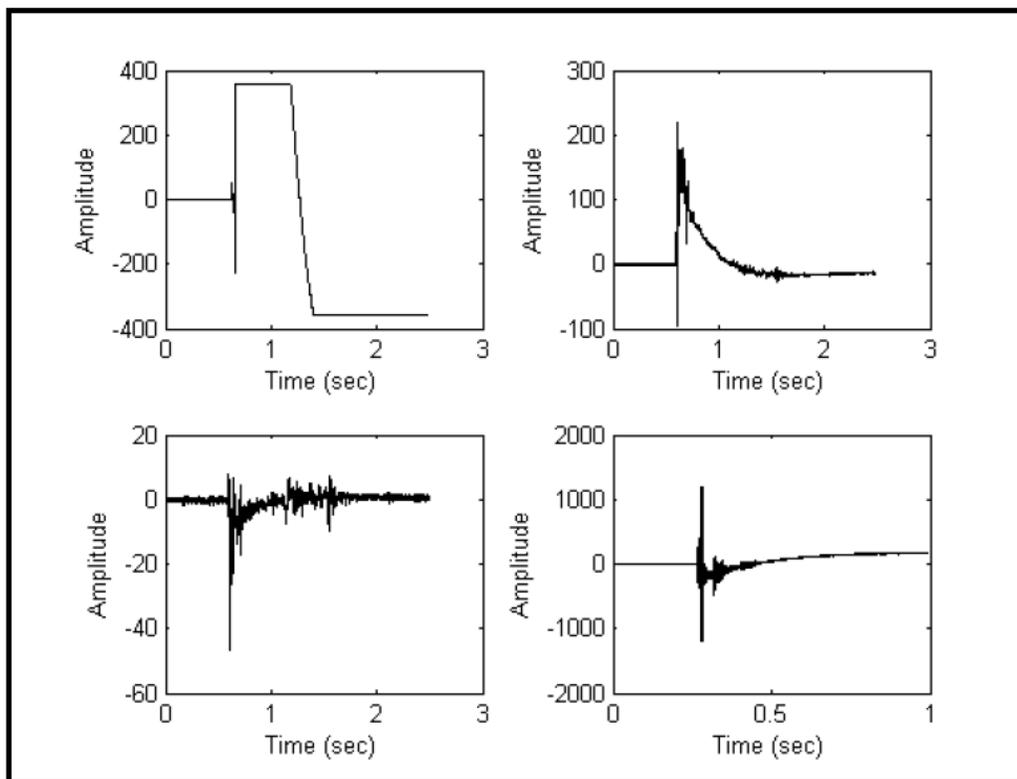


Figure 516.8B-7. Measurement input overdriving the signal conditioning with clipping.

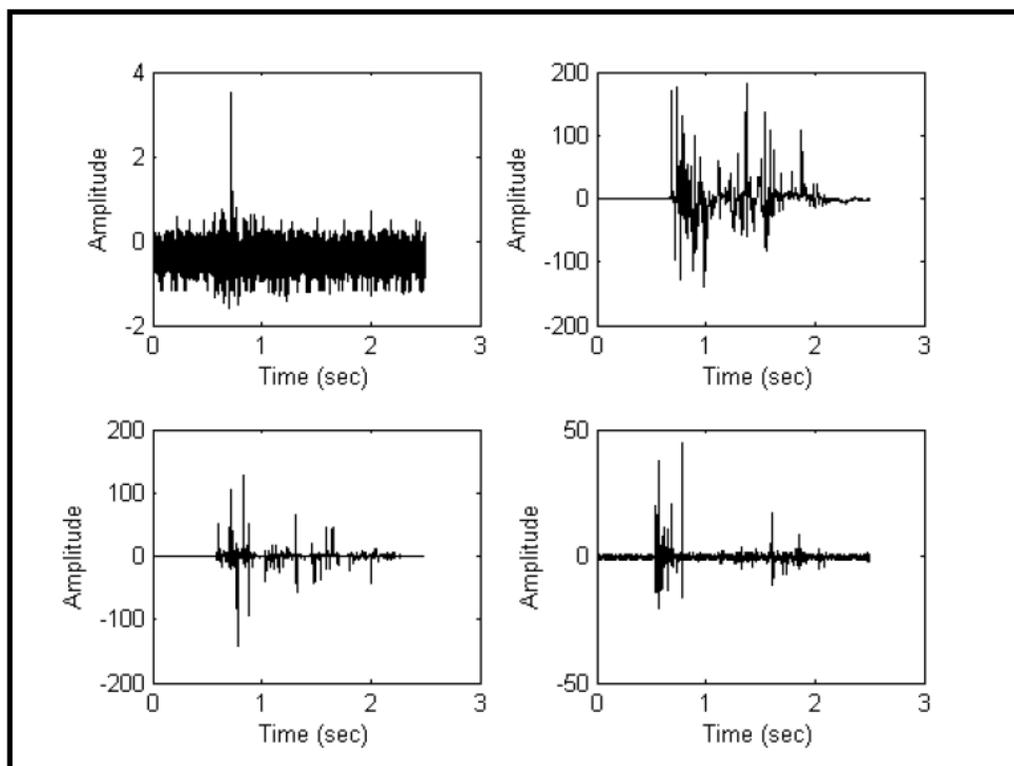


Figure 516.8B-8. Noisy or missing measurement signals.

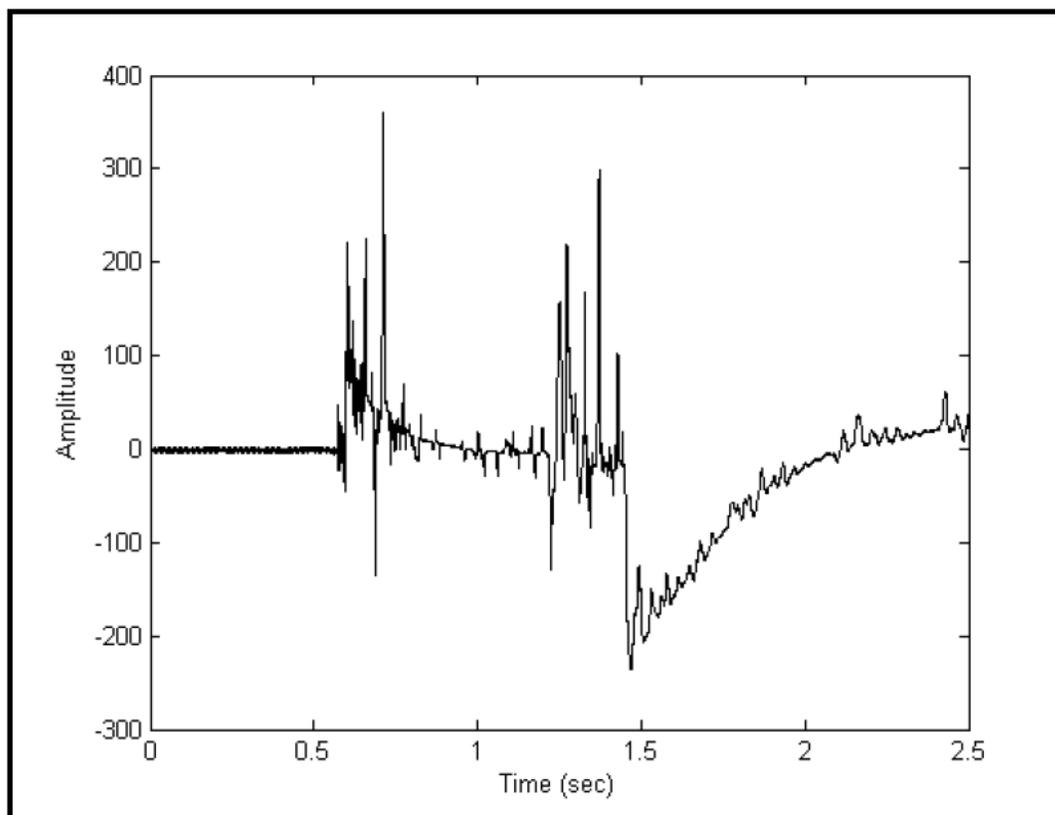
MIL-STD-810H
METHOD 516.8 ANNEX B

Figure 516.8B-9. Combination amplifier overdriving and noise.

Based on similar displays, all of these time histories must be rejected and the source of the problem identified before continuing to make measurements. Figure 516.8B-8 illustrates noise in the system that could be from a loose connector or even a missing sensor. Once again, measurement time histories of this form need to be rejected. Measurement time histories with a few clearly identified noise “spikes” may often be “corrected” by a trained analyst and used.

Finally, Figure 516.8B-9 illustrates a combination of amplifier over driving and noise corruption. Once again, this measurement must be rejected.

MIL-STD-810H
METHOD 516.8 ANNEX B

(This page is intentionally blank.)

MIL-STD-810H
METHOD 516.8 ANNEX C**METHOD 516.8, ANNEX C****STATISTICAL AND PROBABILISTIC CONSIDERATIONS FOR DEVELOPING LIMITS ON
PREDICTED AND PROCESSED DATA ESTIMATES****1. SCOPE.****1.1 Purpose.**

This Annex provides information relative to the statistical and probabilistic characterization of a set of data for the purpose of defining an “upper limit” on the data set. Such an upper limit may be subsequently used for an enveloping procedure for specification development (this Annex provides no guidance on “enveloping procedures,” where an “enveloping procedure” is defined as a procedure providing polynomial interpolation of spectral information for break point definition used directly in exciter control). Although limit estimates defined below may be applicable over a range of different independent variables it will be assumed for convenience that the independent variable is labeled “frequency”. (For other independent variables, e.g., time, serial correlation in the estimates may need to be accounted for in establishing limits.) It is assumed that input is empirical and representative of one of more random processes with unknown probabilistic specification (i.e., if the probabilistic structure of the random processes is known, statistical considerations contained herein would not be pertinent.)

1.2 Application.

Information in this Annex is generally applicable to two or more frequency domain estimates that are either predicted based on given information, or on time domain measurements processed in the frequency domain according to an appropriate technique, e.g., for stationary random vibration, the processing would be an ASD; for a very short transient the processing could be an SRS, ESD, or FS. Given estimates in the frequency domain, information in this Annex will allow the establishment of upper limits on a data set in a statistically correct way with potential for probabilistic interpretation. Statistically based lower limits may be established on a data set of positive amplitude; e.g., ASD or SRS estimates, by inverting the amplitudes and proceeding as in the case of establishment of upper limits, subsequently inverting the resulting ‘upper limit’ for the desired statistically based lower limit. When using a dB representation of amplitude, the process of inversion represents a change in sign for the amplitude, and subsequent application of the ‘upper limit’ procedure such that with sign reversal results in the desired statistically based lower limit.

2. DEVELOPMENT.**2.1 Limit Estimate Set Selection.**

It is assumed that the analyst has clearly defined the objective of the prediction and/or measurement assessment, i.e., to provide a statistically viable limit estimate. Prediction estimates, measurement estimates, or a combination of prediction and measurement estimates may be considered in the same manner. It is assumed that uncertainty in individual measurements (processing error) does not affect the limit considerations. For measured field data digitally processed such that estimates of the ASD, SRS, ESD, or FS are obtained for single sample records, it is imperative to summarize the overall statistics of “similar” estimates selected in a way so as to not bias the limits. Since excessive estimate variance at any independent variable value may lead to overly conservative or meaningless limits depending upon the procedure selected, this choice of “similar estimates” is a way of controlling the variance in the final limit estimates. To ensure that similar estimates are not physically biased, the measurement locations might be chosen randomly, consistent with the measurement objectives. Likewise, similar estimates may be defined as (1) estimates at a single location on materiel that has been obtained from repeated testing under essentially identical experimental conditions; (2) estimates on materiel that have been obtained from one test, where the estimates are taken (a) at several neighboring locations displaying a degree of response homogeneity, or (b) in “materiel zones,” i.e., points of similar response at varying locations, or (3) some combination of (1) and (2). In any case, similar estimates assume that there is a certain degree of homogeneity among the estimates across the frequency band of interest.

2.2 Estimate Processing Considerations.

Once the set of “similar estimates” has been identified the following list of assumptions can be used to ensure limit determination is meaningful.

- a. All estimates are defined over the same bandwidth and at the same independent variable (this is referred to as a “fixed design”).

MIL-STD-810H
METHOD 516.8 ANNEX C

NOTE: A “random design” allows the independent variable to vary among estimates and requires principles of distribution-free non-parametric regression techniques to assess the relationship among the estimates.

- b. The uncertainty or error in individual estimate processing (random or bias processing error) does not significantly affect limit considerations.

NOTE: For Fourier based estimates such as ASD, ESD or FS, the estimate accuracy will be defined in terms of statistical degrees of freedom. For example, a basic periodogram estimate has two statistical degrees of freedom, but through block averaging (in time) using the Welch procedure or averaging of adjacent frequencies (in frequency), the statistical degrees of freedom in the estimate can be increased with subsequent decrease in estimate random error, but potential increase in corresponding estimate bias error. It is important in making estimates that the processing error be minimized (or optimized) in some sense through either extending (if possible) the stationary random time history processing length, or by increasing the estimate bandwidth by frequency averaging. In the case of non-Fourier based estimates such as the SRS, there is little guidance on processing bandwidth selection, except that based upon physical considerations for single-degree-of-freedom systems. In these cases, recommend selection of different damping factors along with bandwidths, and comparing the limits.

- c. Individual estimates from a given measurement are uncorrelated with one another, i.e., there is no serial correlation with respect to the independent variable.

NOTE: For Fourier based estimates, this assumption is usually fulfilled because of the “orthogonality” of the Fourier transform. For non-Fourier based estimates, e.g., SRS, some serial correlation in estimates is unavoidable.

- d. Transformed estimates often are more in line with the assumptions behind the limit determination procedures. For example, using a logarithm transform to yield the estimates in dB will generally leave the estimate set at a given frequency closer to being normally distributed.
- e. Near “optimal limit estimates” may be determined potentially by reprocessing available time trace information through change in the spacing of the independent variable, i.e., the analysis bandwidth. For the case of prediction, this would mean interpolation of the given prediction estimates.
- f. Parametric and non-parametric based limit estimates are available. The analyst should select one or more limit estimates that best aligns with (a) the desired interpretation of the limit assessment, and (b) the character of the set of “similar estimates”.

2.3 Parametric Upper Limit Statistical Estimate Assumptions.

In all the formulas for the estimate of the statistical upper limit of a set of N predictions or processed estimates at a single frequency within the overall estimate bandwidth,

$$\{ X_1, X_2, \dots, X_N \},$$

it is assumed that (1) the estimates will be logarithm transformed to bring the overall set of measurements closer to those sampled of a normal distribution, and (2) the measurement selection bias error is negligible. Since the normal and “t” distribution are symmetric, the formulas below apply for the lower bound by changing the sign between the mean and the standard deviation quantity to minus. It is assumed here that all estimates are at a single frequency or

MIL-STD-810H
METHOD 516.8 ANNEX C

for a single bandwidth, and that estimates among bandwidths are independent, so that each bandwidth under consideration may be processed individually, and the results summarized on one plot over the entire bandwidth as a function of frequency. For

$$y_i = \log_{10}(x_i) \quad i = 1, 2, \dots, N$$

Mean estimate for true mean, μ_y is given by

$$m_y = \frac{1}{N} \sum_{i=1}^N y_i$$

and the unbiased estimate of the standard deviation for the true standard deviation σ_y is given by

$$s_y = \sqrt{\frac{\sum_{i=1}^N (y_i - m_y)^2}{N-1}}$$

2.3.1 NTL - Upper Normal One-Sided Tolerance Limit.

The upper normal one-sided tolerance limit on the proportion β of population values that will be exceeded with a confidence coefficient, γ , is given by $\text{NTL}(N, \beta, \gamma)$, where

$$\text{NTL}(N, \beta, \gamma) = 10^{m_y + s_y k_{N, \beta, \gamma}}$$

where $k_{N, \beta, \gamma}$ is the one-sided normal tolerance factor given in Table 516.8C-I for selected values of N , β and γ . NTL is termed the upper one-sided normal tolerance interval (of the original set of estimates) for which 100 β percent of the values will lie below the limit with 100 γ percent confidence. For $\beta = 0.95$ and $\gamma = 0.50$, this is referred to as the 95/50 limit.

MIL-STD-810H
METHOD 516.8 ANNEX C

Table 516.8C-I. Normal tolerance factors for upper tolerance limit.

N	$\gamma = 0.50$			$\gamma = 0.90$			$\gamma = 0.95$		
	$\beta = 0.90$	$\beta = 0.95$	$\beta = 0.99$	$\beta = 0.90$	$\beta = 0.95$	$\beta = 0.99$	$\beta = 0.90$	$\beta = 0.95$	$\beta = 0.99$
3	1.50	1.94	2.76	4.26	5.31	7.34	6.16	7.66	10.55
4	1.42	1.83	2.60	3.19	3.96	5.44	4.16	5.14	7.04
5	1.38	1.78	2.53	2.74	3.40	4.67	3.41	4.20	5.74
6	1.36	1.75	2.48	2.49	3.09	4.24	3.01	3.71	5.06
7	1.35	1.73	2.46	2.33	2.89	3.97	2.76	3.40	4.64
8	1.34	1.72	2.44	2.22	2.75	3.78	2.58	3.19	4.35
9	1.33	1.71	2.42	2.13	2.65	3.64	2.45	3.03	4.14
10	1.32	1.70	2.41	2.07	2.57	3.53	2.35	2.91	3.98
11	1.32	1.70	2.40	2.01	2.50	3.44	2.28	2.82	3.85
12	1.32	1.69	2.39	1.97	2.45	3.37	2.21	2.74	3.75
13	1.31	1.69	2.39	1.93	2.40	3.31	2.16	2.67	3.66
14	1.31	1.68	2.38	1.90	2.36	3.26	2.11	2.61	3.58
15	1.31	1.68	2.38	1.87	2.33	3.21	2.07	2.57	3.52
16	1.31	1.68	2.38	1.84	2.30	3.17	2.03	2.52	3.46
17	1.31	1.68	2.37	1.82	2.27	3.14	2.00	2.49	3.41
18	1.30	1.67	2.37	1.80	2.25	3.11	1.97	2.45	3.37
19	1.30	1.67	2.37	1.78	2.23	3.08	1.95	2.42	3.33
20	1.30	1.67	2.37	1.77	2.21	3.05	1.93	2.40	3.30
21	1.30	1.67	2.36	1.75	2.19	3.03	1.91	2.37	3.26
22	1.30	1.67	2.36	1.74	2.17	3.01	1.89	2.35	3.23
23	1.30	1.67	2.36	1.72	2.16	2.99	1.87	2.33	3.21
24	1.30	1.67	2.36	1.71	2.15	2.97	1.85	2.31	3.18
25	1.30	1.67	2.36	1.70	2.13	2.95	1.84	2.29	3.16
26	1.30	1.66	2.36	1.69	2.12	2.94	1.82	2.28	3.14
27	1.30	1.66	2.35	1.68	2.11	2.92	1.81	2.26	3.12
28	1.30	1.66	2.35	1.67	2.10	2.91	1.80	2.25	3.10
29	1.29	1.66	2.35	1.66	2.09	2.90	1.79	2.23	3.08
30	1.29	1.66	2.35	1.66	2.08	2.88	1.78	2.22	3.06
32	1.29	1.66	2.35	1.64	2.06	2.86	1.76	2.20	3.03
34	1.29	1.66	2.35	1.63	2.05	2.84	1.74	2.18	3.01
36	1.29	1.66	2.35	1.62	2.03	2.82	1.72	2.16	2.98
38	1.29	1.66	2.35	1.61	2.02	2.81	1.71	2.14	2.96
40	1.29	1.66	2.35	1.60	2.01	2.79	1.70	2.13	2.94
42	1.29	1.66	2.34	1.59	2.00	2.78	1.69	2.11	2.92
44	1.29	1.66	2.34	1.58	1.99	2.77	1.67	2.10	2.91
46	1.29	1.66	2.34	1.57	1.98	2.76	1.66	2.09	2.89
48	1.29	1.66	2.34	1.57	1.97	2.74	1.65	2.08	2.88
50	1.29	1.65	2.34	1.56	1.97	2.73	1.65	2.07	2.86
55	1.28	1.64	2.33	1.54	1.94	2.70	1.62	2.04	2.83
60	1.28	1.64	2.33	1.53	1.93	2.68	1.60	2.02	2.80
65	1.28	1.64	2.33	1.52	1.91	2.67	1.59	2.00	2.78
70	1.28	1.64	2.33	1.51	1.90	2.65	1.58	1.99	2.76
75	1.28	1.64	2.33	1.50	1.89	2.64	1.57	1.97	2.74
80	1.28	1.64	2.33	1.49	1.88	2.63	1.56	1.96	2.73
85	1.28	1.64	2.33	1.48	1.88	2.62	1.55	1.95	2.71
90	1.28	1.64	2.33	1.48	1.87	2.61	1.54	1.94	2.70
95	1.28	1.64	2.33	1.47	1.86	2.60	1.53	1.93	2.69
100	1.28	1.64	2.33	1.47	1.86	2.60	1.52	1.92	2.68
500	1.28	1.64	2.33	1.36	1.74	2.44	1.38	1.76	2.47
1000	1.28	1.64	2.33	1.34	1.71	2.41	1.35	1.73	2.43
∞	1.28	1.64	2.33	1.34	1.71	2.41	1.35	1.73	2.43

MIL-STD-810H
METHOD 516.8 ANNEX C

The table (Table 516.8C-I) from paragraph 6.1, reference b, contains the k value for selected N , β , γ . In general this method of estimation should not be used for small N with values of β and γ close to 1 since it is likely the assumption of the normality of the logarithm transform of the estimates will be violated.

2.3.2 NPL - Upper Normal Prediction limit.

The upper normal prediction limit (NPL) is the value of x (for the original data set) that will exceed the next predicted or measured value with confidence coefficient, γ , and is given by

$$\text{NPL}(N, \gamma) = 10 \left(m_y + s_y \sqrt{1 + \frac{1}{N}} t_{N-1; \alpha} \right)$$

where $\alpha = 1 - \gamma$. $t_{N-1; \alpha}$ is the student t distribution variable with $N-1$ degrees of freedom at the $100\alpha = 100(1-\gamma)$ percentage point of the distribution. This estimate, because of the assumptions behind its derivation, requires careful interpretation relative to measurements made in a given location or over a given estimate zone (paragraph 6.1, reference b).

2.4 Non-parametric Upper Limit Statistical Estimate Procedures.

If there is some reason to believe that the estimate at a given frequency, after they have been logarithm-transformed, will not be sufficiently normally distributed to apply the parametric limits defined above, consideration must be given to nonparametric limits, i.e., limits that are not dependent upon assumptions concerning the distribution of estimate values. In this case there is no need to transform the data estimates. All of the assumptions concerning the selection of estimates are applicable for nonparametric estimates. With additional manipulation, lower bound limits may be computed.

2.4.1 Envelope (ENV) - Upper Limit.

The maximum upper limit is determined by selecting the maximum estimate value in the data set.

$$\text{ENV}(N) = \max \{ x_1, x_2, \dots, x_N \}$$

The main disadvantage of this estimate is that the distributional properties of the estimate set are neglected, so that no probability of exceedance of this value is specified. In the case of outliers in the estimate set, $\text{ENV}(N)$ may be far too conservative. $\text{ENV}(N)$ is also sensitive to the bandwidth of the estimates.

2.4.2 Distribution Free Limit (DFL) - Upper Distribution-Free Tolerance Limit.

The distribution-free tolerance limit that uses the original untransformed sample values is defined to be the upper limit for which at least the fraction β of all sample values will be less than the maximum predicted or measured value with a confidence coefficient of " γ ". This limit is based on order statistic considerations.

$$\text{DFL}(N, \beta, \gamma) = x_{\max}; \gamma = 1 - \beta^N$$

where x_{\max} is the maximum value of the set of estimates, β , is the fractional proportion below x_{\max} , and γ is the confidence coefficient. N , β and γ are not independently selectable. That is

- a. Given N and assuming a value of β , $0 \leq \beta \leq 1$, the confidence coefficient can be determined.
- b. Given N and γ , the proportion β can be determined.
- c. Given β and γ , the number of samples can be determined such that the proportion and confidence can be satisfied (for statistical experiment design).

$\text{DFL}(N, \beta, \gamma)$ may not be meaningful for small samples of data, $N \leq 13$, and comparatively large β , $\beta > 0.95$. $\text{DFL}(N, \beta, \gamma)$ is sensitive to the estimate bandwidth.

MIL-STD-810H
METHOD 516.8 ANNEX C

2.4.3 Empirical Tolerance Limit (ETL) - Upper Empirical Tolerance Limit.

The empirical tolerance limit uses the original sample values and assumes the predicted or measured estimate set is composed of N measurement points over M frequency analysis bandwidths, for a total of NM estimate values. That is

$$\{x_{11}, x_{12}, \dots, x_{1M}; x_{21}, x_{22}, \dots, x_{2M}; x_{N1}, x_{N2}, \dots, x_{NM}\}$$

where m_j is the average estimate at the j th frequency bandwidth over all N measurement points

$$m_j = \frac{1}{N} \sum_{i=1}^N x_{ij} \quad j = 1, 2, \dots, M$$

m_j is used to construct an estimate set normalized over individual frequency resolution bandwidths. That is

$$\{u\} = \{u_{11}, u_{12}, \dots, u_{1M}, u_{21}, u_{22}, \dots, u_{2M}, u_{N1}, u_{N2}, \dots, u_{NM}\}$$

$$\text{where: } u_{ij} = \frac{x_{ij}}{m_j} \quad i = 1, 2, \dots, N; j = 1, 2, \dots, M$$

The normalized estimate set, $\{u\}$, is ordered from smallest to largest and $u_\beta = u_{(k)}$ where $u_{(k)}$ is the k^{th} ordered element of set $\{u\}$ for $0 < \beta = \frac{k}{MN} \leq 1$ is defined. For each resolution frequency bandwidth, then

$$\text{ETL}(\beta) = u_\beta m_j = x_{\beta j} \quad j = 1, 2, \dots, M$$

Using m_j implies that the value of $\text{ETL}(\beta)$ at j exceeds β percent of the values with 50 percent confidence. If a value other than m_j is selected, the confidence level may increase. It is important that the set of estimates is homogeneous to use this limit, i.e., they have about the same spread in all frequency bands. In general, apply this limit only if the number of measurement points, N , is greater than 10.

3. EXAMPLE.

3.1 Input Test Data Set.

Table 516.8C-II represents a homogeneous table of normally distributed numbers of unity variance around a mean value of 3.5 with $N=14$ rows and $M=5$ columns (rows could represent fourteen individual test measurements and columns could represent test values over five data sets). Table 516.8C-II is used in the upper limit determinations in paragraphs 3.2 and 3.3 below.

Table 516.8C-II. Input test data set.

Data Set 1	Data Set 2	Data Set 3	Data Set 4	Data Set 5
3.0674	3.3636	2.0590	2.4435	3.8803
1.8344	3.6139	4.0711	4.9151	2.4909
3.6253	4.5668	3.1001	2.6949	3.4805
3.7877	3.5593	4.1900	4.0287	3.4518
2.3535	3.4044	4.3156	3.7195	3.5000
4.6909	2.6677	4.2119	2.5781	3.1821
4.6892	3.7902	4.7902	1.3293	4.5950
3.4624	2.1638	4.1686	3.4408	1.6260
3.8273	4.2143	4.6908	2.4894	3.9282
3.6746	5.1236	2.2975	4.1145	4.3956
3.3133	2.8082	3.4802	4.0077	4.2310
4.2258	4.3580	3.3433	5.1924	4.0779
2.9117	4.7540	1.8959	4.0913	3.5403
5.6832	1.9063	3.7573	2.8564	4.1771

MIL-STD-810H
METHOD 516.8 ANNEX C

3.2 Parametric Upper Limits.

The upper normal one-sided tolerance limit (NTL) is computed as 95/50 limit with 50 percent confidence that at least 95 percent of the values will lie below this limit for $k_{N, \beta, \gamma} = 1.68$ from Table 516.8C-I. The upper normal prediction limit (NPL) is computed with a 95 confidence coefficient at the 95 percent point of the distribution where $t_{N-1; \alpha} = t_{13; 0.05} = 1.771$. Figure 516.8C-1 displays the data, and Figure 516.8C-2 displays the two parametric upper limits.

NOTE: The degree of conservativeness in the normal prediction upper limit over the normal tolerance limit.

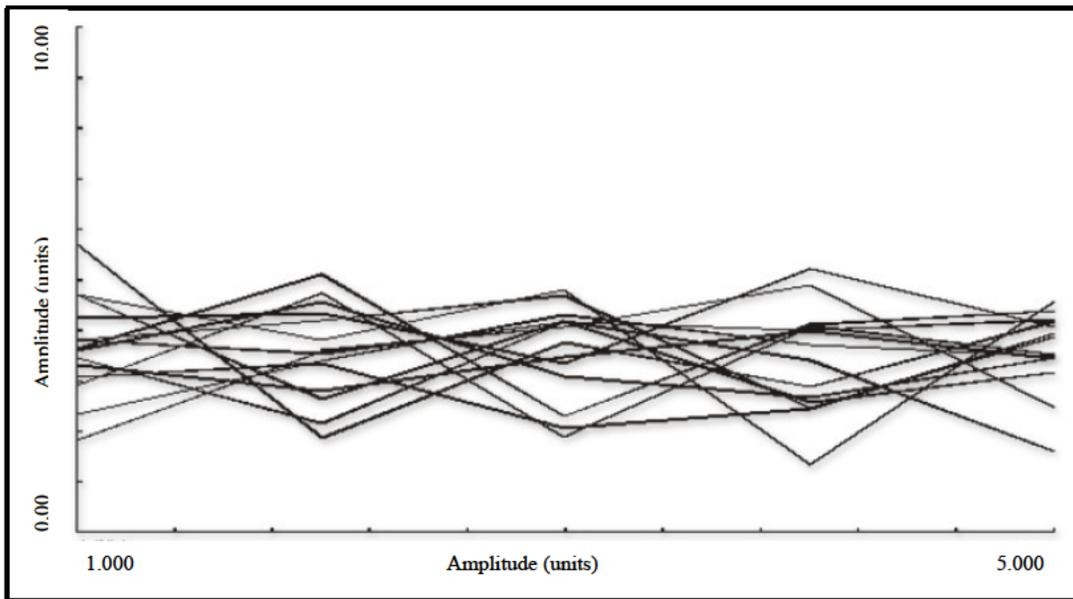


Figure 516.8C-1. Input test data set.

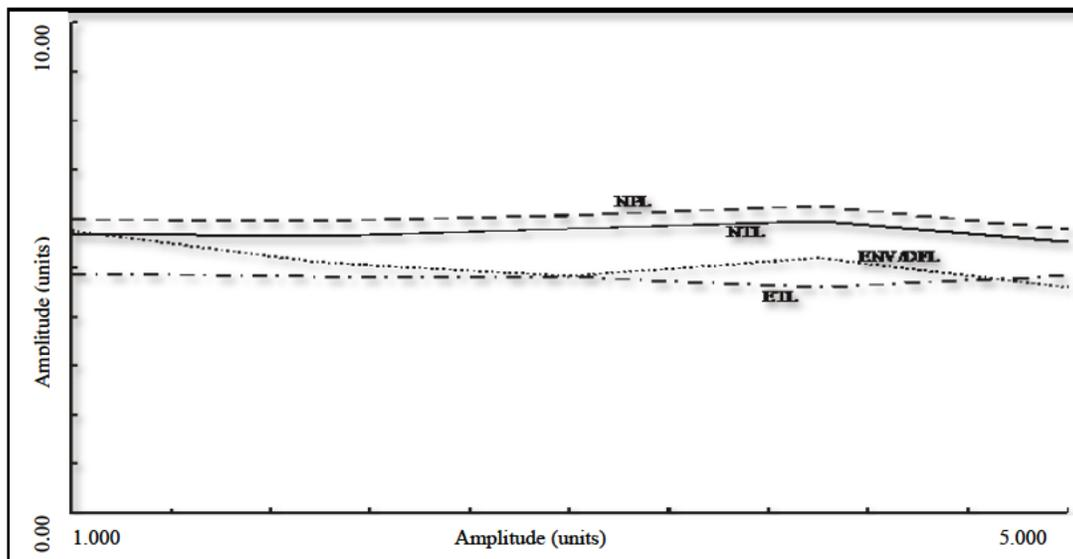


Figure 516.8C-2. Parametric and non-parametric upper limits.

MIL-STD-810H
METHOD 516.8 ANNEX C

3.3 Non-parametric Upper Limits.

The envelope limit (ENV) along with the upper distribution-free tolerance limit (DFL) for β proportion of the population set at 0.95 and γ confidence coefficient of 0.51 for $N=14$ samples is displayed in Figure 516.8C-2. This represents one curve with two interpretations. The 95 percent upper empirical tolerance limit (ETL) is also displayed on Figure 516.8C-2 where at least 95 percent of the values will be exceeded by this limit with 50 percent confidence. The data are displayed on Figure 516.8C-2 for comparison purposes.

3.4 Observations.

The “flatness” of the upper limits on Figure 516.8C-2 attests to the homogeneity of the data in Table 516.8C-II. It is apparent from Figure 516.8C-2 that the upper limits for the parameters selected are not “statistically equivalent.” Of the two upper limit estimates, the NTL is favored if it can be established that the logarithm transform of the data set is approximately normally distributed. The closeness of the nonparametric envelopes attests also to the homogeneity of the data in Table 516.8C-II in addition to demonstrating, for this case at least, the non-statistical ENV, the statistically based DFL and the ETL basically agree with regard to the upper limit magnitude. For non-homogeneous data sets ETL would not be expected to agree with ENV or DFL. For small data sets, ETL may vary depending upon if parameter k rounds upward or downward.

4. RECOMMENDED PROCEDURES.

4.1 Recommended Statistical Procedures for Upper Limit Estimates.

Paragraph 6.1, reference b, provides a detailed discussion of the advantages and disadvantages of estimate upper limits. The guidelines in this reference are recommended. In all cases, plot the data carefully with a clear indication of the method of establishing the upper limit and the assumptions behind the method used.

- a. When N is sufficiently large, i.e., $N \geq 7$, establish the upper limit by using the expression for the DFL for a selected $\beta \geq 0.90$ such that $\gamma \geq 0.50$.
- b. When N is not sufficiently large to meet the criterion in (a), establish the upper limit by using the expression for the NTL. Select β and $\gamma \geq 0.50$. Variation in β will determine the degree of conservativeness of the upper limit.
- c. For $N > 10$ and a confidence coefficient of 0.50, the upper limit established on the basis of ETL is acceptable and may be substituted for the upper limit established by DFL or NTL. It is important when using ETL to examine and confirm the homogeneity of the estimates over the frequency bands.

4.2 Uncertainty Factors.

Uncertainty factors may be added to the resulting upper limits if confidence in the data is low or the data set is small. Factors on the order of 3 dB to 6 dB may be added. Paragraph 6.1, reference b recommends a 5.8 dB uncertainty factor (based on “flight-to-flight” uncertainties of 3 dB, and “point-to-point” uncertainties of 5 dB) be used with captive carry flight measured data to determine a maximum expected environment using a normal tolerance limit. It is important that all uncertainties be clearly defined, and that uncertainties are not superimposed upon estimates that already account for uncertainty.

MIL-STD-810H
METHOD 517.3**METHOD 517.3**
PYROSHOCK**CONTENTS**

<u>Paragraph</u>	<u>Page</u>
1. SCOPE	1
1.1 PURPOSE	1
1.2 APPLICATION	1
1.2.1 PYROSHOCK	1
1.2.2 PYROSHOCK - MOMENTUM EXCHANGE	2
1.2.3 PYROSHOCK - PHYSICAL PHENOMENON.....	2
1.2.4 CLASSIFICATION OF PYROSHOCK ZONES.....	2
1.3 LIMITATIONS	3
2. TAILORING GUIDANCE	3
2.1 SELECTING THE PYROSHOCK METHOD	3
2.1.1 EFFECTS OF PYROSHOCK.....	3
2.1.2 SEQUENCE AMONG OTHER METHODS.....	4
2.2 SELECTING A PROCEDURE.....	4
2.2.1 PROCEDURE SELECTION CONSIDERATIONS	4
2.2.2 DIFFERENCE AMONG PROCEDURES.....	5
2.3 DETERMINE TEST LEVELS AND CONDITIONS	5
2.3.1 GENERAL CONSIDERATIONS - TERMINOLOGY.....	5
2.3.2 SINGLE PYROSHOCK EVENT MEASUREMENT SYSTEM CHARACTERIZATION AND BASIC PROCESSING.....	11
2.3.3 TEST CONDITIONS - SHOCK SPECTRUM TRANSIENT DURATION AND SCALING	14
2.3.3.1 PYROSHOCK SOURCE ENERGY SCALING (SES).....	14
2.3.3.2 PYROSHOCK RESPONSE LOCATION DISTANCE SCALING (RLDS).....	14
2.3.3.3 MEASURED DATA AVAILABLE FROM PYROSHOCK	15
2.3.3.4 MEASURED DATA NOT AVAILABLE FROM PYROSHOCK	16
2.3.4 TEST AXES, DURATION, AND NUMBER OF SHOCK EVENTS	18
2.3.4.1 GENERAL	18
2.3.4.2 PROCEDURE I - NEAR-FIELD WITH AN ACTUAL CONFIGURATION.....	18
2.3.4.3 PROCEDURE II - NEAR-FIELD WITH A SIMULATED CONFIGURATION	18
2.3.4.4 PROCEDURE III - MID-FIELD WITH A MECHANICAL TEST DEVICE.....	19
2.3.4.5 PROCEDURE IV - FAR-FIELD WITH A MECHANICAL TEST DEVICE.....	19
2.3.4.6 PROCEDURE V - FAR-FIELD WITH AN ELECTRODYNAMIC SHAKER.....	19
2.4 TEST ITEM CONFIGURATION	19
3. INFORMATION REQUIRED.....	19
3.1 PRETEST.....	19
3.2 DURING TEST.....	20
3.3 POST-TEST	20
4. TEST PROCESS	20
4.1 TEST FACILITY	20
4.2 CONTROLS	21
4.2.1 CALIBRATION.....	21
4.2.2 TOLERANCES.....	21

MIL-STD-810H
METHOD 517.3**CONTENTS - Continued**

<u>Paragraph</u>	<u>Page</u>
4.2.2.1 PROCEDURE I - NEAR-FIELD WITH AN ACTUAL CONFIGURATION AND PROCEDURE II - NEAR-FIELD WITH A SIMULATED CONFIGURATION	21
4.2.2.2 PROCEDURE III - MID-FIELD WITH A MECHANICAL TEST DEVICE	21
4.2.2.3 PROCEDURE IV - FAR-FIELD WITH A MECHANICAL TEST DEVICE	22
4.2.2.4 PROCEDURE V - FAR-FIELD WITH AN ELECTRODYNAMIC SHAKER	22
4.2.3 INSTRUMENTATION	22
4.2.4 DATA ANALYSIS	24
4.3 TEST INTERRUPTION	24
4.3.1 INTERRUPTION DUE TO LABORATORY EQUIPMENT MALFUNCTION	24
4.3.2 INTERRUPTION DUE TO TEST ITEM OPERATION FAILURE	24
4.4 TEST EXECUTION	25
4.4.1 PREPARATION FOR TEST	25
4.4.1.1 PRELIMINARY STEPS	25
4.4.1.2 PRETEST CHECKOUT	25
4.4.2 TEST PROCEDURES	25
4.4.2.1 PROCEDURE I - NEAR-FIELD WITH ACTUAL CONFIGURATION	26
4.4.2.2 PROCEDURE II - NEAR-FIELD WITH SIMULATED CONFIGURATION	26
4.4.2.3 PROCEDURE III - MID-FIELD USING MECHANICAL TEST DEVICE	26
4.4.2.4 PROCEDURE IV - FAR-FIELD USING MECHANICAL TEST DEVICE	27
4.4.2.5 PROCEDURE V - FAR-FIELD USING ELECTRODYNAMIC SHAKER	28
5. ANALYSIS OF RESULTS	28
5.1 PROCEDURE I - NEAR-FIELD WITH ACTUAL CONFIGURATION	28
5.2 PROCEDURE II - NEAR-FIELD WITH SIMULATED CONFIGURATION	28
5.3 PROCEDURE III - MID-FIELD USING MECHANICAL TEST DEVICE	28
5.4 PROCEDURE IV - FAR-FIELD USING MECHANICAL TEST DEVICE	29
5.5 PROCEDURE V - FAR-FIELD USING ELECTRODYNAMIC SHAKER	29
6. REFERENCE/RELATED DOCUMENTS	29
6.1 REFERENCED DOCUMENTS	29
6.2 RELATED DOCUMENTS	30

FIGURES

FIGURE 517.3-1. FULL DURATION NEAR-FIELD, LASER PYROSHOCK TIME HISTORY (MEAN REMOVED, FILTERED AT 200 KHZ)	6
FIGURE 517.3-2 FULL DURATION NEAR-FIELD, LASER PYROSHOCK VELOCITY TIME HISTORY	7
FIGURE 517.3-3 FULL DURATION NEAR-FIELD, ACCELEROMETER PYROSHOCK TIME HISTORY	8
FIGURE 517.3-4 FULL DURATION NEAR-FIELD, ACCELEROMETER PYROSHOCK VELOCITY TIME HISTORY	8
FIGURE 517.3-5 ACCELERATION MAXIMAX SRS FOR THE PYROSHOCK, PRE-PYROSHOCK, AND POST PYROSHOCK (LASER)	9
FIGURE 517.3-6 MAXIMAX PSEUDO-VELOCITY RESPONSE SPECTRUM FOR THE PYROSHOCK (LASER)	10
FIGURE 517.3-7 FILTER ATTENUATION (CONCEPTUAL, NOT FILTER SPECIFIC)	12
FIGURE 517.3-8. ILLUSTRATION OF SAMPLING RATES AND OUT OF BAND "FOLD OVER" FREQUENCIES FOR DATA ACQUISITION SYSTEMS	13
FIGURE 517.3-9 EMPIRICAL SCALING RELATIONSHIP FOR SHOCK RESPONSE SPECTRUM AS A FUNCTION OF THE DISTANCE FROM THE PYROTECHNIC SOURCE	15
FIGURE 517.3-10 SHOCK RESPONSE SPECTRA FOR VARIOUS POINT SOURCE PYROTECHNIC DEVICES	17
FIGURE 517.3-11 SHOCK RESPONSE SPECTRUM VERSUS DISTANCE FROM PYROTECHNIC SOURCE	17
FIGURE 517.3-12 PEAK PYROSHOCK RESPONSE VERSUS DISTANCE FROM PYROTECHNIC SOURCE	18

MIL-STD-810H
METHOD 517.3

CONTENTS - Continued

Paragraph **Page**

METHOD 517.3 ANNEX A

GUIDELINES FOR ADDITIONAL PYROSHOCK TIME HISTORY VALIDATION AND PROCESSING

1.	INTRODUCTION	A-1
2.	ALIASED DATA.....	A-1
3.	SLEW RATE CONTAMINATED DATA	A-4
4.	ACCELEROMETER DATA WITH BASE STRAIN EFFECTS.....	A-9

ANNEX A FIGURES

FIGURE 517.3A-1.	A NEAR-FIELD PYROSHOCK FOLLOWED BY TWO MECHANICAL SHOCK EVENTS	A-2
FIGURE 517.3A-2.	THE INTEGRAL OF THE ACCELERATION DATA IN FIGURE 517.3A-1	A-2
FIGURE 517.3A-3.	DISCRETE FOURIER TRANSFORM OF THE DATA IN FIGURE 517.3A-1	A-3
FIGURE 517.3A-4.	THE SHOCK RESPONSE SPECTRA OF THE ACCELERATION DATA IN FIGURE 517.3A-1 (Q=10).....	A-3
FIGURE 517.3A-5.	A NEAR-FIELD PYROSHOCK ACCELERATION TIME HISTORY	A-4
FIGURE 517.3A-6.	THE INTEGRAL OF THE ACCELERATION DATA IN FIGURE 517.3A-5	A-5
FIGURE 517.3A-7.	DISCRETE FOURIER TRANSFORM OF THE DATA IN FIGURE 517.3A-5	A-6
FIGURE 517.3A-8.	SHOCK RESPONSE SPECTRUM OF THE ACCELERATION TIME HISTORY FIGURE 517.3A-5 (Q=10) A-6	
FIGURE 517.3A-9.	TIME HISTORY OF WAVELET CORRECTION REMOVED FROM THE ACCELERATION TIME HISTORY IN FIGURE 517.3A-5	A-7
FIGURE 517.3A-10.	SHOCK RESPONSE SPECTRUM COMPARISON FOR CORRUPTED ACCELERATION (FIGURE 517.3A-5) AND REMOVED WAVELET CORRECT (FIGURE 517.3A-9) (Q=10).....	A-7
FIGURE 517.3A-11.	SHOCK RESPONSE SPECTRUM CALCULATED FOR THE WAVELET CORRECTED ACCELERATION TIME HISTORY (Q=10)	A-8
FIGURE 517.3A-12.	A NEAR-FIELD PYROSHOCK ACCELERATION TIME HISTORY	A-8
FIGURE 517.3A-13.	THE INTEGRAL OF THE ACCELERATION DATA IN FIGURE 517.3A-12	A-9
FIGURE 517.3A-14.	A NEAR-FIELD PYROSHOCK ACCELERATION TIME HISTORY	A-10
FIGURE 517.3A-15.	THE INTEGRAL OF THE ACCELERATION DATA IN FIGURE 517.3A-14	A-10

MIL-STD-810H
METHOD 517.3

(This page is intentionally blank.)

MIL-STD-810H
METHOD 517.3**METHOD 517.3****PYROSHOCK**

NOTE: Tailoring is essential. Select methods, procedures, and parameter levels based on the tailoring process described in Part One, paragraph 4.2.2, and Annex C. Apply the general guidelines for laboratory test methods described in Part One, paragraph 5 of this Standard.

1. SCOPE.**1.1 Purpose.**

Pyroshock tests involving pyrotechnic (explosive- or propellant-activated) devices are performed to:

- a. Provide a degree of confidence that materiel can structurally and functionally withstand the infrequent shock effects caused by the detonation of a pyrotechnic device on a structural configuration to which the materiel is mounted.
- b. Experimentally estimate the materiel's fragility level in relation to pyroshock in order that shock mitigation procedures may be employed to protect the materiel's structural and functional integrity.

1.2 Application.**1.2.1 Pyroshock.**

Pyroshock is often referred to as pyrotechnic shock. For the purpose of this document, initiation of a pyrotechnic device will result in an effect that is referred to as a "pyroshock." "Pyroshock" refers to the localized intense mechanical transient response of materiel caused by the detonation of a pyrotechnic device on adjacent structures. A number of devices are capable of transmitting such intense transients to a materiel. In general, the sources may be described in terms of their spatial distribution - point sources, line sources and combined point and line sources (paragraph 6.1, reference a). Point sources include explosive bolts, separation nuts, pin pullers and pushers, bolt and cable cutters and pyro-activated operational hardware. Line sources include flexible linear shape charges (FLSC), mild detonating fuzes (MDF), and explosive transfer lines. Combined point and line sources include V-band (Marmon) clamps. The loading from the pyrotechnic device may be accompanied by the release of structural strain energy from structure preload or impact among structural elements as a result of the activation of the pyrotechnic device. Use this Method to evaluate materiel likely to be exposed to one or more pyroshocks in its lifetime. Pyroshocks are generally within a frequency range between 100 Hz and 1,000,000 Hz, and at a duration from 50 microseconds to not more than 20 milliseconds. Acceleration response amplitudes to pyroshock may range from 300 g's to 200,000 g's. The acceleration response time history to pyroshock will, in general, be very oscillatory and have a substantial rise time, approaching 10 microseconds. In general, pyroshocks generate material stress waves that will excite materiel to respond to very high frequencies with wavelengths on the order of sizes of micro-electronic chip configurations. Because of the limited velocity change in the structure brought about by firing of the pyrotechnic device, and the localized nature of the pyrotechnic device, structural resonances of materiel below 500 Hz will normally not be excited and the system will undergo very small displacements with small overall structural/mechanical damage. The pyroshock acceleration environment in the neighborhood of the materiel will usually be highly dependent upon the configuration of the materiel and the intervening structure. The materiel or its parts may be in the near-field, mid-field or far-field of the pyrotechnic device with the pyroshock environment in the near-field being the most severe, and that in the mid-field or far-field less severe. In general, some structure intervenes between the materiel and location of the pyrotechnic device that results in the "mid-field," and "far-field." There is now agreement on classifying pyroshock intensity according to the characteristics of "near-field," "mid-field," and "far-field." This document reflects the current consensus for three regions according to simulation techniques as "near-field," "mid-field," and "far-field" for which the definitions are provided in paragraph 1.2.4.

MIL-STD-810H
METHOD 517.3

1.2.2 Pyroshock - Momentum Exchange.

Pyroshock usually exhibits no momentum exchange between two bodies (a possible exception is the transfer of strain energy from stress wave propagation from a device through structure to the materiel). Pyroshock results in essentially no velocity change in the materiel support structure. Frequencies below 100 Hz are never of concern. The magnitude of a pyroshock response at a given point reasonably far from the pyrotechnic source is, among other things, a function of the size of the pyrotechnic charge. Pyroshock is a result of linear elastic material waves propagating in the support structure to the materiel without plastic deformation of large portions of the structure except at the charge point or line. In general, joints and bolted connections representing structure discontinuities tend to greatly attenuate the pyroshock amplitudes. Pyroshock is “designed” into the materiel by placement of pyroshock devices for specific use. Because to a great extent the pyroshock environment is clearly defined by the geometrical configuration and the charge or the activating device, pyroshock response of materiel in the field may be moderately predictable and repeatable for materiel (paragraph 6.1, reference a).

1.2.3 Pyroshock - Physical Phenomenon.

Pyroshock is a physical phenomenon characterized by the overall material and mechanical response at a structure point from either (a) an explosive device, or (b) a propellant activated device. Such a device may produce extreme local pressure (with perhaps heat and electromagnetic emission) at a point or along a line. The device provides a near instantaneous generation of local, high-magnitude, nonlinear material strain rates with subsequent transmission of high-magnitude/high frequency material stress waves producing high acceleration/low velocity and short duration response at distances from the point or line source. The characteristics of pyroshock are:

- a. Near-the-source stress waves in the structure caused by high material strain rates (nonlinear material region) propagate into the near-field and beyond.
- b. High frequency (100 Hz to 1,000,000 Hz) and very broadband frequency input.
- c. High acceleration (300 g's to 200,000 g's) but low structural velocity and displacement response.
- d. Short-time duration (< 20 msec).
- e. High residual structure acceleration response (after the event).
- f. Caused by (1) an explosive device or (2) a propellant activated device (releasing stored strain energy) coupled directly into the structure; (for clarification, a propellant activated device includes items such as a clamp that releases strain energy causing a structure response greater than that obtained from the propellant detonation alone).
- g. Highly localized point source input or line source input.
- h. Very high structural driving point impedance (P/v , where P is the large detonation force or pressure, and v , the structural velocity, is very small). At the pyrotechnic source, the driving point impedance can be substantially less if the structure material particle velocity is high.
- i. Response time histories that are random in nature, providing little repeatability and substantial dependency on the materiel configuration details.
- j. Response at points on the structure that are greatly affected by structural discontinuities
- k. Materiel and structural response that may be accompanied by substantial heat and electromagnetic emission (from ionization of gases during explosion).

1.2.4 Classification of Pyroshock Zones.

The nature of the response to pyroshock suggests that the materiel or its components may be classified as being in the near-field, mid-field or far-field of the pyrotechnic device. The terms “near-field,” “mid-field,” and “far-field” relate to the shock intensity at the response point, and such intensity is a function of the distance from the pyrotechnic source and the structural configuration between the source and the response point. The definitions that follow are based on simulation techniques consistent with paragraph 6.1, reference b.

- a. Near-field. In the near-field of the pyrotechnic device, the structure material stress wave propagation effects govern the response. A near-field pyroshock test requires frequency control up to and above 10,000 Hz for

MIL-STD-810H
METHOD 517.3

amplitudes greater than 10,000g's. A pyrotechnically excited simulation technique is usually appropriate, although in some cases a mechanically excited simulation technique may be used.

- b. Mid-field. In the mid-field of the pyrotechnic device, the pyroshock response is governed by a combination of material stress wave propagation and structural resonance response effects. A mid-field pyroshock test requires frequency control from 3,000 Hz to 10,000 Hz for amplitudes less than 10,000g's. A mechanically excited simulation technique other than shaker shock is usually required.
- c. Far-field. In the far-field of the pyrotechnic device, the pyroshock response is governed by a combination of material stress wave propagation and structural resonance response effects. A Far-field pyroshock test requires frequency control no higher than 3,000 Hz for amplitudes less than 1,000g's. A shaker shock or a mechanically excited simulation technique is appropriate.

Distances from the pyrotechnic device have been avoided in these definitions because specific distances restrict structural dimensions and imply point or line pyrotechnic sources with specific weights and densities. The definitions are based on experimental capabilities, but still should be considered guidelines because all structures with their corresponding pyrotechnic devices are different.

1.3 Limitations.

Because of the highly specialized nature of pyroshock, apply it only after giving careful consideration to information contained in paragraph 6.1, references a, b, c, and d. This Method does not apply to the following:

- a. The shock effects experienced by materiel as a result of any mechanical shock/transient vibration, shipboard shock, or EMI shock. For these types of shocks, see the appropriate methods in this or other standards.
- b. The effects experienced by fuze systems that are sensitive to shock from pyrotechnic devices. Shock tests for safety and operation of fuzes and fuze components may be performed in accordance with MIL-STD-331 (paragraph 6.1, reference c).
- c. Special provisions for performing pyroshock tests at high or low temperatures. Perform tests at room ambient temperature unless otherwise specified, or if there is reason to believe that testing at either the high or low operational temperature may enhance the pyroshock environment.
- d. Manned space vehicle testing (see paragraph 6.1, reference a).
- e. Secondary effects such as induced blast, EMI, and thermal effects.
- f. Effects of hostile weapon penetration or detonation. (Refer to Method 522.2, Ballistic Shock.)

2. TAILORING GUIDANCE.

2.1 Selecting the Pyroshock Method.

After examining requirements documents and applying the tailoring process in Part One of this Standard to determine where pyroshock effects are foreseen in the life cycle of the materiel, use the following to confirm the need for this Method and to place it in sequence with other Methods.

2.1.1 Effects of Pyroshock.

In general, pyroshock has the potential for producing adverse effects on all electronic materiel. The level of adverse effects generally increases with the level and duration of the pyroshock, and decreases with the distance from the source (pyrotechnic device) of the pyroshock. Durations for pyroshock that produce material stress waves with wavelengths that correspond with the natural frequency wavelengths of microelectronic components within materiel will enhance adverse effects. In general, the structural configuration merely transmits the elastic waves and is unaffected by the pyroshock. Examples of problems associated with pyroshock follow, but the list is not intended to be all-inclusive.

- a. Materiel failure as a result of destruction of the structural integrity of micro-electronic chips.
- b. Materiel failure as a result of relay chatter.
- c. Materiel failure as a result of circuit card malfunction, circuit card damage, and electronic connector failure. On occasion, circuit card contaminants having the potential to cause short circuits may be dislodged under pyroshock.

MIL-STD-810H
METHOD 517.3

- d. Materiel failure as a result of cracks and fracture in crystals, ceramics, epoxies, or glass envelopes.

2.1.2 Sequence Among Other Methods.

- a. General. Use the anticipated life cycle sequence of events as a general sequence guide (see Part One, paragraph 5.5).
- b. Unique to this Method. Unless otherwise displayed in the life cycle profile and, since pyroshock is normally experienced near the end of the life cycle, schedule pyroshock tests late in the test sequence. In general, the pyroshock tests can be considered independent of the other tests because of their unique nature.

2.2 Selecting a Procedure.

NOTE: For materiel design and development, the option of tailoring of a laboratory shock test *from field measurement information* is superior to any of the test procedures within this Method, and should be the first laboratory test option. This assumes that the measurement data bandwidth and the laboratory test bandwidths are strictly compatible.

This Method includes five pyroshock test procedures:

- a. Procedure I - Near-field with an Actual Configuration. Replication of pyroshock for the near-field environment using the actual materiel, and the associated pyrotechnic shock test device configuration.
- b. Procedure II - Near-field with a Simulated Configuration. Replication of pyroshock for the near-field environment using the actual materiel, but with the associated pyrotechnic shock test device isolated from the test item, e.g., by being mounted on the back of a flat steel plate. (This normally will minimize testing costs because fewer materiel configurations and/or platforms associated with the test item will be damaged. This can be used for repeated tests at varying pyroshock levels.)
- c. Procedure III - Mid-field with a Mechanical Test Device. Replication of pyroshock for the mid-field environment with a mechanical device that simulates the pyroshock peak acceleration amplitudes and frequency content (other than an electrodynamic shaker because of frequency range and weight limitations of an electrodynamic shaker).
- d. Procedure IV - Far-field with a Mechanical Test Device. Replication of pyroshock for the far-field environment with a mechanical device that simulates the pyroshock peak acceleration amplitudes and frequency content (other than an electrodynamic shaker because of frequency range and weight limitations of an electrodynamic shaker).
- e. Procedure V - Far-field with an Electrodynamic Shaker. Replication of pyroshock for the far-field environment using an electrodynamic shaker to simulate the comparatively low frequency structural resonant response to the pyroshock.

2.2.1 Procedure Selection Considerations.

Based on the test data requirements, determine which test procedure is applicable. In most cases, the selection of the procedure will be dictated by the actual materiel configuration, carefully noting any structural discontinuities that may serve to mitigate the effects of the pyroshock on the materiel. In some cases, the selection of the procedure will be driven by test practicality. Consider all pyroshock environments anticipated for the materiel during its life cycle, both in its logistic and operational modes. When selecting procedures, consider:

- a. The Operational Purpose of the Materiel. From the requirements documents, determine the functions to be performed by the materiel either during or after exposure to the pyroshock environment.
- b. The Natural Exposure Circumstances for Pyroshock. Determine if the materiel or portion of the materiel lies within the near-field, mid-field or far-field of the pyrotechnic device. Use Procedure I or II if the materiel or a portion of the materiel lies within the near-field of the pyrotechnic device, no special isolation of the materiel exists, or if there are no prior measured field data. Choose Procedure III, IV, or V based on the frequency content and amplitude of available data, as well as the limitations of the test device. In any case,

MIL-STD-810H
METHOD 517.3

one test will be considered sufficient for testing over the entire amplitude and frequency range of exposure of the materiel. Do not break up any measured or predicted response to pyroshock into separate frequency ranges for the purpose of applying different testing procedures to different frequency ranges.

- c. Required Data. The test data required to verify that the materiel will survive and function as intended.

2.2.2 Difference Among Procedures.

- a. Procedure I - Near-field with Actual Configuration. Procedure I is intended to test materiel in its functional mode and actual configuration (materiel/pyrotechnic device physical configuration), and to ensure it can survive and function as required when tested using the actual pyrotechnic test device in its intended installed configuration. In Procedure I, it is assumed that the materiel or a portion of the materiel resides within the near-field of the pyrotechnic device.
- b. Procedure II - Near-field with Simulated Configuration. Procedure II is intended to test materiel in its functional mode, but with a simulated structural configuration, and to ensure it can survive and function as required when in its actual materiel/pyrotechnic device physical configuration. In this procedure it is assumed that some part of the materiel lies within the near-field. Make every attempt to use this procedure to duplicate the actual platform/materiel structural configuration by way of a full-scale test. If this is too costly or impractical, employ scaled tests provided that, in the process of scaling, important configuration details are not omitted. In particular, only the structure portion directly influencing the materiel may be involved in the test, provided it can be reasonably assumed that the remainder of the structure will not influence materiel response. On occasion, for convenience, a special pyrotechnic testing device may be employed for testing the materiel, e.g., a flat steel plate to which the materiel is mounted and the pyrotechnic charge is attached.
- c. Procedure III - Mid-field with a Mechanical Test Device. Pyroshock can be applied using conventional high acceleration amplitude/frequency test input devices. Paragraph 6.1, reference b, provides a source of alternative test input devices, their advantages, and limitations. In this procedure, it is assumed that all parts of the materiel lie in the mid-field of the pyrotechnic device. Consult paragraph 6.1, reference b, for guidelines and considerations for such testing for frequencies between 3,000 and 10,000 Hz. In some cases all three axes may be obtained with one impact to mechanical test device.
- d. Procedure IV - Far-field Using a Mechanical Test Device. Pyroshock can be applied using conventional high acceleration amplitude/frequency test input devices. Paragraph 6.1, reference b provides a source of alternative test input devices, their advantages, and limitations. In this procedure, it is assumed that all parts of the materiel lie in the far-field of the pyrotechnic device. Consult paragraph 6.1, reference b, for guidelines and considerations for such testing for frequencies less than 3,000 Hz.
- e. Procedure V - Far-field Using an Electrodynamic Shaker. On occasion, pyroshock response can be replicated using conventional electrodynamic shakers. In this procedure, it is assumed that all parts of the materiel lie in the far-field of the pyrotechnic device, and the materiel is subject to the structure platform resonant response alone for frequencies less than 3,000 Hz.

2.3 Determine Test Levels and Conditions.

Having selected one of the five pyroshock procedures (based on the materiel's requirements documents and the tailoring process), complete the tailoring process by identifying appropriate parameter levels, applicable test conditions, and applicable test techniques for that procedure. Exercise extreme care in consideration of the details in the tailoring process. Base these selections on the requirements documents, the Life Cycle Environmental Profile (LCEP), and information provided with this procedure. Consider the following basic information when selecting test levels.

2.3.1 General Considerations - Terminology.

Pyroshock is the most difficult of mechanical environments to measure and, consequently, has more stringent requirements than other mechanical environments. In general, response acceleration will be the experimental variable of measurement for pyroshock. However, this does not preclude other variables of measurement such as velocity, displacement, or strain from being measured and processed in an analogous manner, as long as the interpretation, capabilities, and limitations of the measurement variable and measurement system are well-defined. Pay particular attention to the high frequency environment generated by the pyrotechnic device, and the capabilities of the

MIL-STD-810H
METHOD 517.3

measurement system to faithfully record the materiel's responses. Paragraph 6.1, references a and b detail the tradeoffs among pyroshock measurement techniques. Ensure the guidelines in paragraph 6.1, references b and d, are implemented. For the purpose of this Method, the terms that follow will be helpful in the discussion relative to analysis of response measurements from pyroshock testing. To facilitate the definition of the terms, each of the terms is illustrated for a typical pyroshock measurement. Figure 517.3-1 provides an acceleration time history plot of a measured near-field pyroshock measured with a laser Doppler vibrometer, with the instrumentation noise floor displayed before the pyroshock, the pyroshock, and the subsequent post-pyroshock noise floor. It is important to provide measurement data including both the pre-pyroshock noise measurement and the post-pyroshock combined noise, and low level residual structure response. The arrows at three discrete times are used to identify a pre-pyroshock, pyroshock, and a post-pyroshock response. The pre-pyroshock time interval contains the instrumentation system noise floor, and serves as a measurement signal reference level. The pyroshock time interval includes all the significant response energy of the event. The post-pyroshock time interval, the third arrow, is of a slightly longer duration to the pre-pyroshock time interval and contains the measurement system noise in addition to some of the pyroshock residual noise considered inconsequential to the response energy in the pyroshock. In cases in which the pre-pyroshock and the post-pyroshock amplitude levels are substantial compared to the pyroshock (the pyroshock has been mitigated and/or the measurement system noise is high), the identification of the pyroshock may be difficult, and engineering judgment must be used relative to determining the start and the termination of the pyroshock event. In any case, analysis of pre-pyroshock and post-pyroshock measurement information in conjunction with the pyroshock measurement information is essential. Validate all data collected from a pyroshock. Paragraph 6.1, references b and d, provide guidelines for this. The simplest and most sensitive criterion for validation is an integration of the signal time history after removing any small residual offset (mean), a standard practice for pyroshock data analysis. If the resulting integrated signal has zero crossings and does not appear to monotonically increase, the pyroshock has passed this validation test (net velocity is equal to zero). Figure 517.3-2 provides the velocity plot for the long duration pyroshock on Figure 517.3-1. Further information on interpretation of the integral of the acceleration time history or the velocity time history is shown in Annex A of this Method.

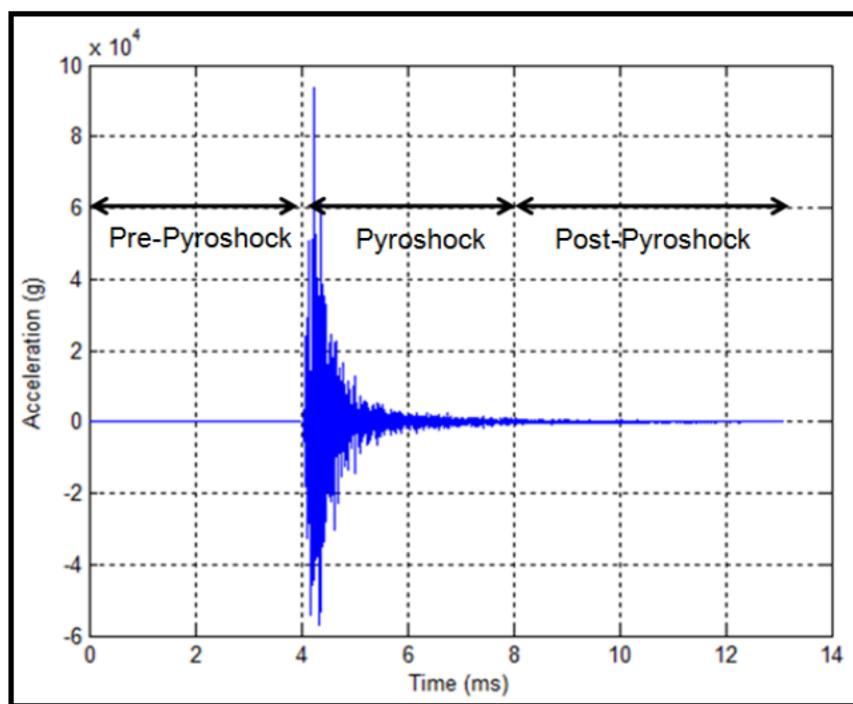


Figure 517.3-1. Full duration near-field, laser pyroshock time history (mean removed, filtered at 200 KHz).

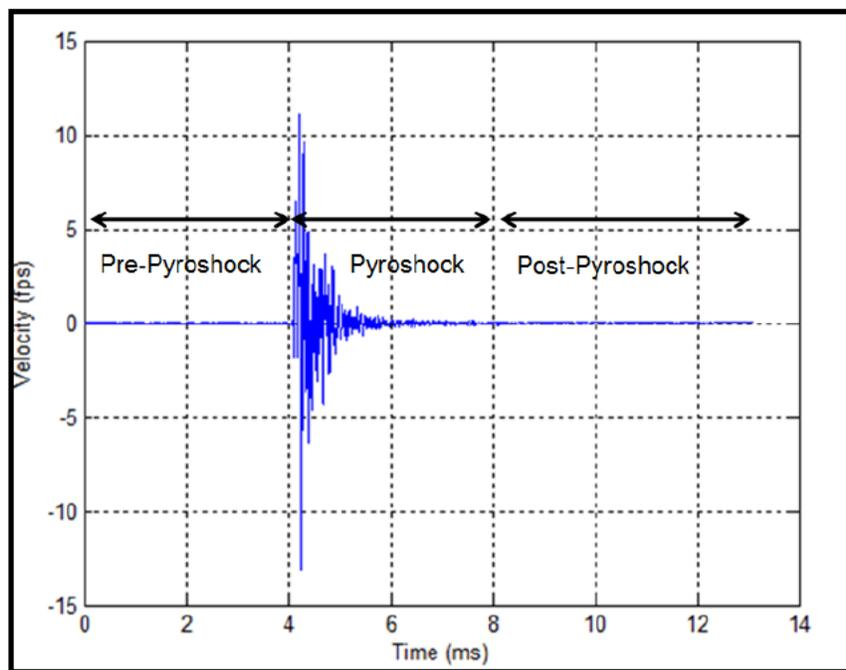
MIL-STD-810H
METHOD 517.3

Figure 517.3-2. Full duration near-field, laser pyroshock velocity time history.

- (1) **Effective Transient Duration:** The "effective transient duration," T_e , is defined in this Method to be the minimum length of time that contains all significant amplitude time history magnitudes beginning at the noise floor of the instrumentation system just prior to the initial most significant measurement, and proceeding to the point that the amplitude time history is a combination of measurement noise and substantially decayed structural response. In general, an experienced analyst is required to determine the pertinent measurement information to define the pyroshock event. The longer the duration of the pyroshock, the more low frequency information is preserved that may be important in far-field test considerations for the pyroshock. For near-field test considerations, in general, the effective transient duration will be much shorter because of the nature of the event. The amplitude criterion requires that the amplitude of the post-pyroshock amplitude time history envelope be no more than 12 dB above the noise floor of the measurement system depicted in the pre-pyroshock amplitude time history. From Figure 517.3-1, there is a time interval for the duration of the pyroshock based on the velocity time history in Figure 517.3-2 that clearly shows that the pyroshock event is over after 4 milliseconds. The "effective transient duration," T_e , occurs from 4 milliseconds to 8 milliseconds when the velocity time history in Figure 517.3-2 effectively returns to zero. Consequently, there are 4 milliseconds of pre-pyroshock information, 4 milliseconds of pyroshock, information, and 5 milliseconds of post-pyroshock information. Figure 517.3-3 has the acceleration time history for the same event shown in Figure 517.3-1 (side-by-side measurements), and shows lower amplitudes than the laser Doppler vibrometer data in Figure 517.3-1. This will always occur because the accelerometer has a larger measurement area than the laser Doppler vibrometer that is essentially a point measurement. Thus, the accelerometer acts as a spatial integrator. The initial noise floor level is never obtained after the long duration pyroshock. Figure 517.3-4 contains the integral of Figure 517.3-3, and has the same time intervals as the laser Doppler vibrometer measurement. The magnitude of the SRS at selected natural frequencies (particularly high frequencies) can be quite insensitive to the effective transient duration. As Figure 517.3-5 demonstrates, the low frequency pyroshock SRS slope is +9 dB/octave to +12 dB/octave slope (or +1.5 to +2.0 on a log-log plot). The "knee" frequency is the dominant frequency in a pyroshock SRS, at which the slope for the SRS changes from an approximate +9 dB/octave to +12 dB/octave slope to an approximately horizontal slope with peaks at the major local structural frequencies. All pyroshock SRS have a knee frequency, even if not properly measured or

MIL-STD-810H
METHOD 517.3

quantified. Paragraph 6.1, reference b, details the different SRS characteristics of near-field pyroshock (no “knee” frequency below 10,000 Hz) and mid-field and far-field pyroshock containing a “knee” frequency in their respective frequency ranges.

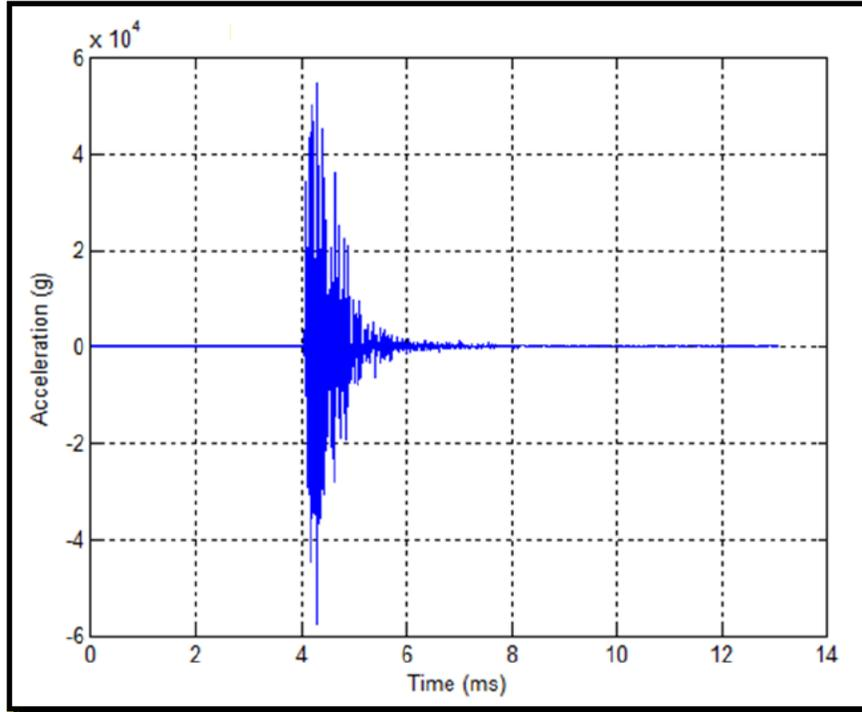


Figure 517.3-3. Full duration near-field, accelerometer pyroshock time history.

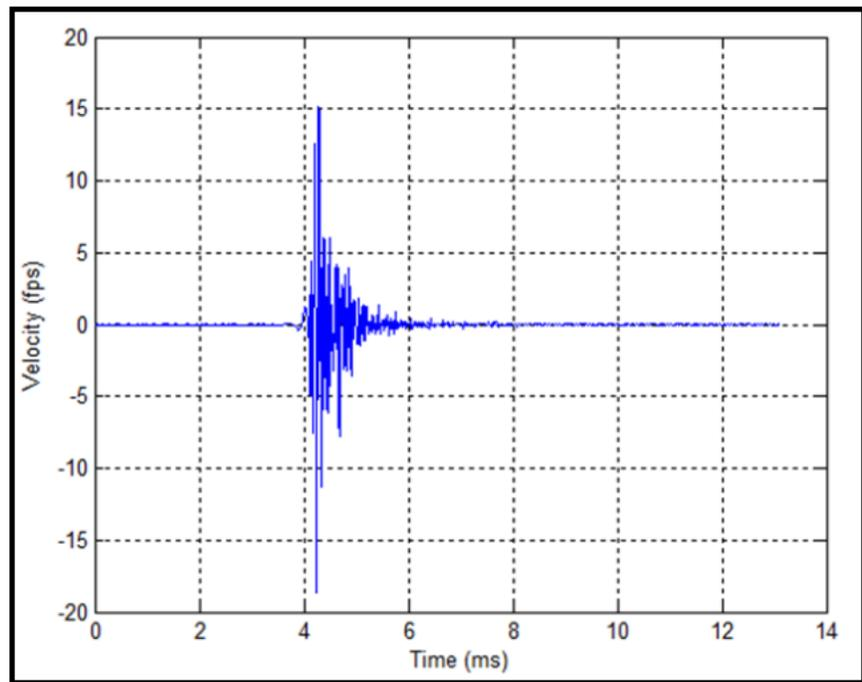


Figure 517.3-4. Full duration near-field, accelerometer pyroshock velocity time history.

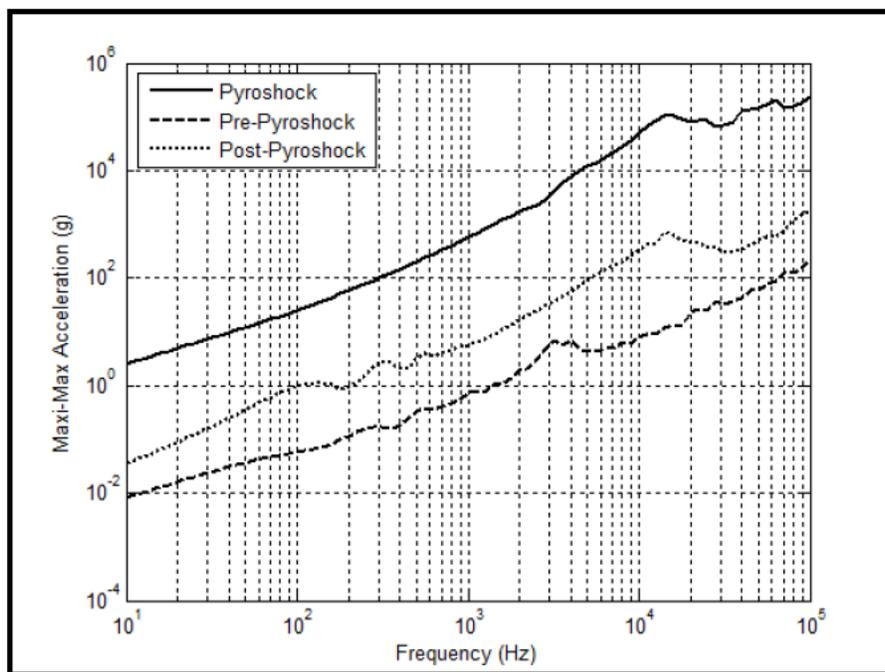
MIL-STD-810H
METHOD 517.3

Figure 517.3-5. Acceleration maximax SRS for the pyroshock, pre-pyroshock and post pyroshock (laser).

- (2) Shock Response Spectrum analysis: Paragraph 6.1, references e and f, defines the absolute acceleration maximax Shock Response Spectrum (SRS), and provides examples of SRS computed for classical pulses. The SRS value at a given un-damped oscillator natural frequency, f_n , is defined to be the absolute value of the maximum of the positive and negative acceleration responses of a mass for a given base input to a damped single degree of freedom system. The base input is the measured shock over a specified duration (the specified duration should be the effective transient duration, T_e). For processing of pyroshock response data, the absolute acceleration maximax SRS has become the primary analysis descriptor. In this measurement description of the pyroshock, the maximax absolute acceleration values are plotted on the ordinate with the un-damped natural frequency of the single degree of freedom system, with base input plotted along the abscissa. A more complete description of the pyroshock (and potentially more useful for pyroshock damage comparison in the far-field) can be obtained by determining the maximax pseudo-velocity response spectrum and plotting this on four-coordinate paper where, in pairs of orthogonal axes, (1) the maximax pseudo-velocity response spectrum is represented by the ordinate with the un-damped natural frequency being the abscissa, and (2) the maximax absolute acceleration along with the maximax pseudo-displacement plotted in a pair of orthogonal axes (paragraph 6.1, reference e). The maximax pseudo-velocity at a particular oscillator un-damped natural frequency is thought to be more representative of the damage potential for a shock since it correlates with stress and strain in the elements of a single degree of freedom system (paragraph 6.1, references f, g, and h). The maximax pseudo-velocity response spectrum can be computed either by (1) dividing the maximax absolute acceleration response spectrum by the un-damped natural frequency of the single degree of freedom system, or (2) multiplying the maximax relative displacement by the un-damped natural frequency of the single degree of freedom system. Both means of computation provide essentially the same spectra except possibly in the lower frequency region, in which case the second method of computation is more basic to the definition of the maximax pseudo-velocity response spectrum. Figure 517.3-5 provides the maximax absolute acceleration SRS for the pyroshock record on Figure 517.3-1. Figure 517.3-6 provides the maximax pseudo-velocity for this record on four-coordinate paper. Information below 100 Hz for the maximax absolute acceleration SRS may reveal data anomalies not detected otherwise or confirm erroneous velocity change (see Annex A of this Method). Figure 517.3-6 shows that maximum pseudo-velocity of almost

MIL-STD-810H
METHOD 517.3

500 ips occurs above 10,000 Hz. The high velocity change at high frequency is indicative of the damage potential for electronic components. In general, compute the SRS over the pyroshock event duration and over the same duration for the pre-pyroshock and the post-pyroshock events with twelfth octave spacing, and a $Q = 10$ ($Q=10$ corresponds to a single degree of freedom system with 5 percent critical damping). If the testing is to be used for laboratory simulation, use a second Q value of 50 ($Q=50$ corresponds to a single degree of freedom system with 1 percent critical damping) in the processing. It is recommended that the maximax absolute acceleration SRS be the primary method of display for the pyroshock and the maximax pseudo-velocity SRS be the secondary method of display. The maximax pseudo-velocity SRS is useful in cases in which it is desirable to correlate damage of simple systems with the pyroshock.

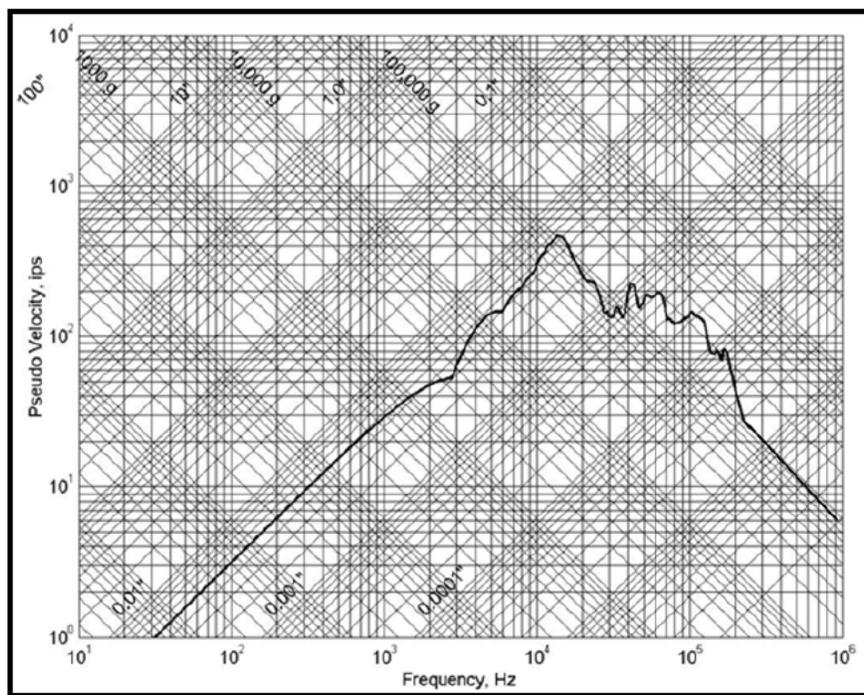


Figure 517.3-6. Maximax pseudo-velocity response spectrum for the pyroshock (laser).

- (3) **Other Methods:** Over the past few years, at least two other techniques potentially useful in processing pyroshock data have been suggested. Paragraph 6.1, reference i, describes the use of time domain or temporal moments for comparing the characteristics of the pyroshock over different frequency bands. The usefulness of this technique resides in the fact that if the pyroshock can be represented by a simple non-stationary product model, the time domain moments must be constant over selected filter bandwidths. Thus, the pyroshock can be characterized by a model with potential usefulness for stochastic simulation. Paragraph 6.1, reference j, explores this reasoning for mechanical shock. Paragraph 6.1, reference k, describes the use of wavelets for vibration. It has been suggested that wavelet processing may be useful for pyroshock description, particularly if a pyroshock contains information at intervals of time over the duration of the shock at different time scales, i.e., different frequencies.
- b. In general, for pyroshock tests, a single response record is obtained. At times, it may be convenient or even necessary to combine equivalent processed responses in some appropriate statistical manner. Paragraph 6.1, references a and l, and Method 516.8, Annex B of this Standard discuss some options in statistically summarizing processed results from a series of tests. In general, processed results, either from the SRS, ESD, or FS are logarithmically transformed in order to provide estimates that are more normally distributed. This

MIL-STD-810H
METHOD 517.3

is important since often very little data are available from a test series, and the probability distribution of the untransformed estimates cannot be assumed to be normally distributed. In general, the combination of processed results will fall under the category of small sample statistics and needs to be considered with care. Parametric or less powerful nonparametric methods of statistical analysis may usually be effectively applied.

2.3.2 Single Pyroshock Event Measurement System Characterization and Basic Processing.

The following paragraphs discuss basic measurement system acquisition characteristics, followed by a discussion of the correct identification of the parts of a measured pyroshock (in particular the duration of a pyroshock). Information in Method 516.8, Annex A and Annex A of this Method is essential for the processing of measured data for a laboratory test specification.

In this paragraph with its subdivisions, proper identification of a single pyroshock will be illustrated. Once the pyroshock has been correctly identified, processing is generally routine as per the details in paragraph 2.3.1. Pyroshock event identification is important for deciding upon the manner of testing in the laboratory. Within the time domain characterization, anticipating further digital processing, it is assumed the measured data are properly signal conditioned, and subsequently digitized with a minimum of aliased information into the bandwidth of interest (less than five percent) and, in general, the measurement time history has been validated. Details for validation are contained Paragraph 6.1, references b and d.

The following information corresponding to the time domain characterization must be present for assessment by an analyst in establishing pyroshock requirements:

- a. Signal bandwidth, i.e., DC to f_{\max} where f_{\max} is the maximum frequency of interest consistent with the analog, anti-alias filter design built into the analog signal conditioning, i.e., $f_{\max} < f_{AA}$ where f_{AA} is the 3dB half-power point cut-off frequency of the lowpass analog anti-alias filter. Generally, for SRS analysis in order to get accurate estimates at f_{\max} , it is required that the analog, anti-alias rolloff be taken into account so that it does not interfere with the SRS filter estimates at f_{\max} . Likewise, digital filters must be in place before digital decimation.
- b. Digital signal sample rate F_s , shall be such that the anti-alias filter provides a minimum attenuation as shown in Figure 517.3-7. The digitizing rate shall be at least 1 MHz or higher as per Paragraph 6.1, reference p. Paragraph 6.1, references b and d, recommend a minimum 60 dB/octave anti-alias filter, with the half-power point cut-off frequency set at $f_c < 0.6 * f_{Nyquist}$. The requirements of this section are an equivalent way to achieve the same aliasing protection with more flexibility in other data parameters. For higher rates of roll-off, f_c can be increased, but must never exceed $0.8 * f_{Nyquist}$. For $10 * f_{\max} < F_s$, re-sampling will be necessary for SRS computation to preserve filtering accuracy. The final sample rate shall meet or exceed ten times the maximum frequency of interest, i.e., $F_s > 10 * f_{\max}$.
- c. The data recording instrumentation shall have flat frequency response to at least 100 kHz for all channels at each measurement location. Attenuation of 3 dB at 100 kHz is acceptable. The digitizing rate must be at least 1 MHz or higher so that measurements of peak amplitude to qualify the shock level are accurate. Additional, lower frequency measurement channels, at the same location may be used for lower frequency response measurements.

It is imperative that a responsibly designed system to reject aliasing is employed. Analog anti-alias filters must be in place before the digitizer. The selected anti-alias filtering must have an attenuation of 50 dB or greater, and a pass band flatness within +/- 1.0 dB and phase linearity to within +/- 5° across the frequency bandwidth of interest for the measurement (see Figure 517.3-7). Subsequent resampling e.g., for purposes of decimation, must be in accordance with standard practices and consistent with the analog anti-alias configuration (e.g. digital filters must be in place before subsequent decimations).

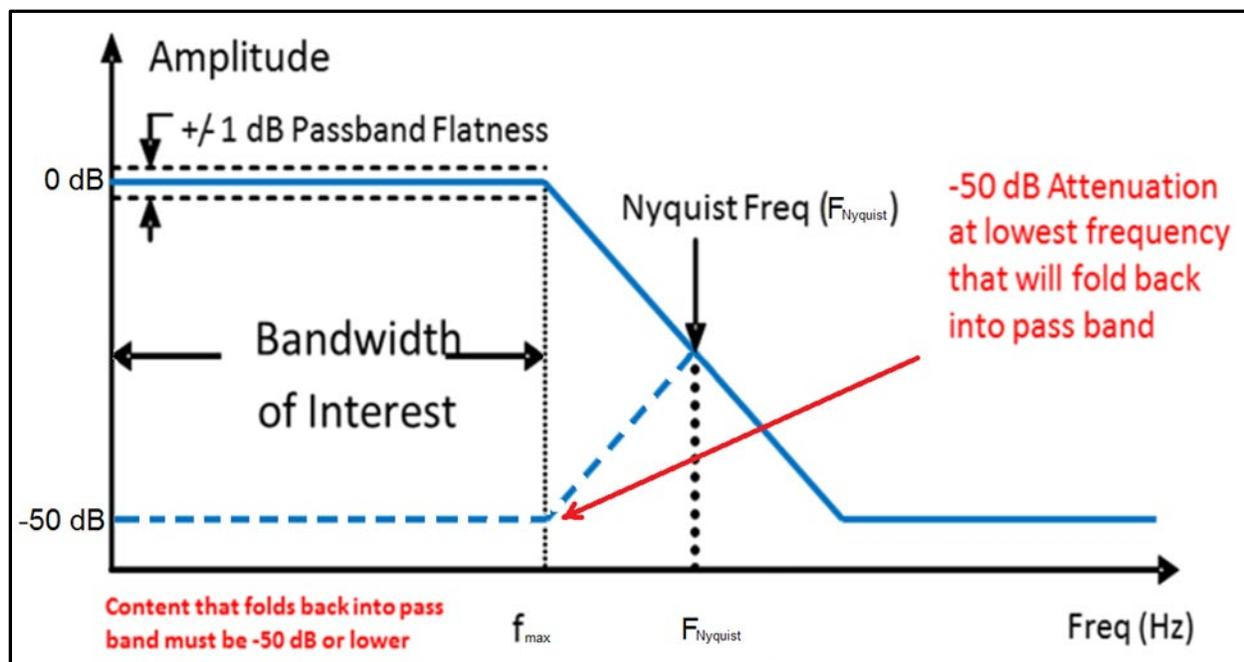
MIL-STD-810H
METHOD 517.3

Figure 517.3-7. Filter attenuation (conceptual, not filter specific).

The end to end alias rejection of the final digitized output must be shown to meet the requirements in Figure 517.3-7. The anti-alias characteristics must provide an attenuation of 50 dB or greater for frequencies that will fold back into the passband. Spectral data including SRS plots may only be presented for frequencies within the passband (between 0 and f_{max}). However, this restriction is not to constrain digital data validation procedures that require assessment of digitally acquired data to the Nyquist frequency (either for the initial ADC or subsequent resampled sequences). It should be noted that it is possible that certain sensor/signal conditioning systems may display substantial “out-of-band” frequency content, i.e., greater than f_{Max} but less than the Nyquist frequency, in digital processing. For example, a Fourier spectra estimate over the duration of the shock may display “general signal” to “noise” that seemingly contradicts the filter attenuation criterion displayed in Figure 517.3-7. In this case the signal conditioning/digitizing system must be subject to the “verification of alias rejection” described in the paragraph to follow. If the signal conditioning system is verified as non-aliasing then the substantial frequency content between f_{Max} and the Nyquist frequency can be digitally filtered out if desired.

Verification of alias rejection should start by establishing the dynamic range within the pass band in terms of the signal to noise ratio (SNR). The voltage-based $SNR = 20 \log_{10} (V_{FullScale} / V_{NoiseFloor})$ must be ≥ 60 dB. Once sufficient SNR is verified, establishing the alias rejection characteristics may be determined using an input sine wave with a magnitude of $0.5 * \text{full scale range}$ and at the lowest frequency range that can impinge i.e., be aliased into f_{Max} , and then confirming (using the IEEE 1057 sine wave test procedure or through inspection of the time domain data) that the alias rejection is sufficient at this frequency for the signal conditioning system.

For a conventional multi-bit ADC such as flash or successive approximation design, if a 1 million sample/second digitizing rate is used, for example, then $f_{Nyquist} = 500$ KHz. Theory says that if a signal above the Nyquist Ratio is present, it will “fold over” into a frequency below the Nyquist ratio. The equation is:

$F_a = \text{absolute value } [(F_s * n) - F]$, where

$F_a = \text{frequency of “alias”}$

$F = \text{frequency of input signal}$

$F_s = \text{sample rate}$

$n = \text{integer number of sample rate } (F_s) \text{ closest to input signal frequency } (F)$

Hence, the lowest frequency range that can fold back into the 100 KHz passband is from 900 KHz to 1.1 MHz.

MIL-STD-810H
METHOD 517.3

It should be noted that Sigma Delta (SD) digitizers “oversample” internally at a rate several times faster than the output data rate and that analog anti-alias filtering is still required. For illustrative purposes, consider an example for a SD digitizer with a bandwidth of interest up to 100 KHz that samples internally at $f_s = 8$ million samples/second. The internal analog based Nyquist frequency by definition is 4 MHz, hence the analog anti-alias filter should attenuate 50 dB or more content that can fold back into the 100 KHz pass band (7.9 MHz to 8.1 MHz and similar bands that are higher in frequency). Figure 517.3.8 illustrates sampling frequencies, Nyquist frequencies, and frequency bands that can fold back into the bandwidth of interest for both conventional and over sampling digitizers, such as the Sigma Delta. Observe that for the example SD design, there is significant bandwidth above the 100 KHz desired f_{Max} and the Nyquist rate that is not useable due primarily to quantization error, an artifact of the single bit SD design. The output of a SD ADC will be digitally filtered and resampled yielding a new effective sampling rate f_{DR} which in turn yields a new Nyquist rate for the decimated signal of $f_{DR}/2$. Through careful selection the digital filter cutoff frequency, the majority of noise between $f_{DR}/2$ and f_s is removed while maintaining a nearly flat frequency response through f_{Max} . The SD oversampling rate $OSR = f_s/f_{DR}$, which is directly correlated to dynamic range, is one of several design parameters for a SD ADC. Most reputable vendors will provide a detailed specification sheet associated with their products, however, it is strongly recommended that one verifies aliasing rejection and noise floor characteristics as recommended above prior to employing any signal conditioning/digitizing system in the acquisition of critical field data.

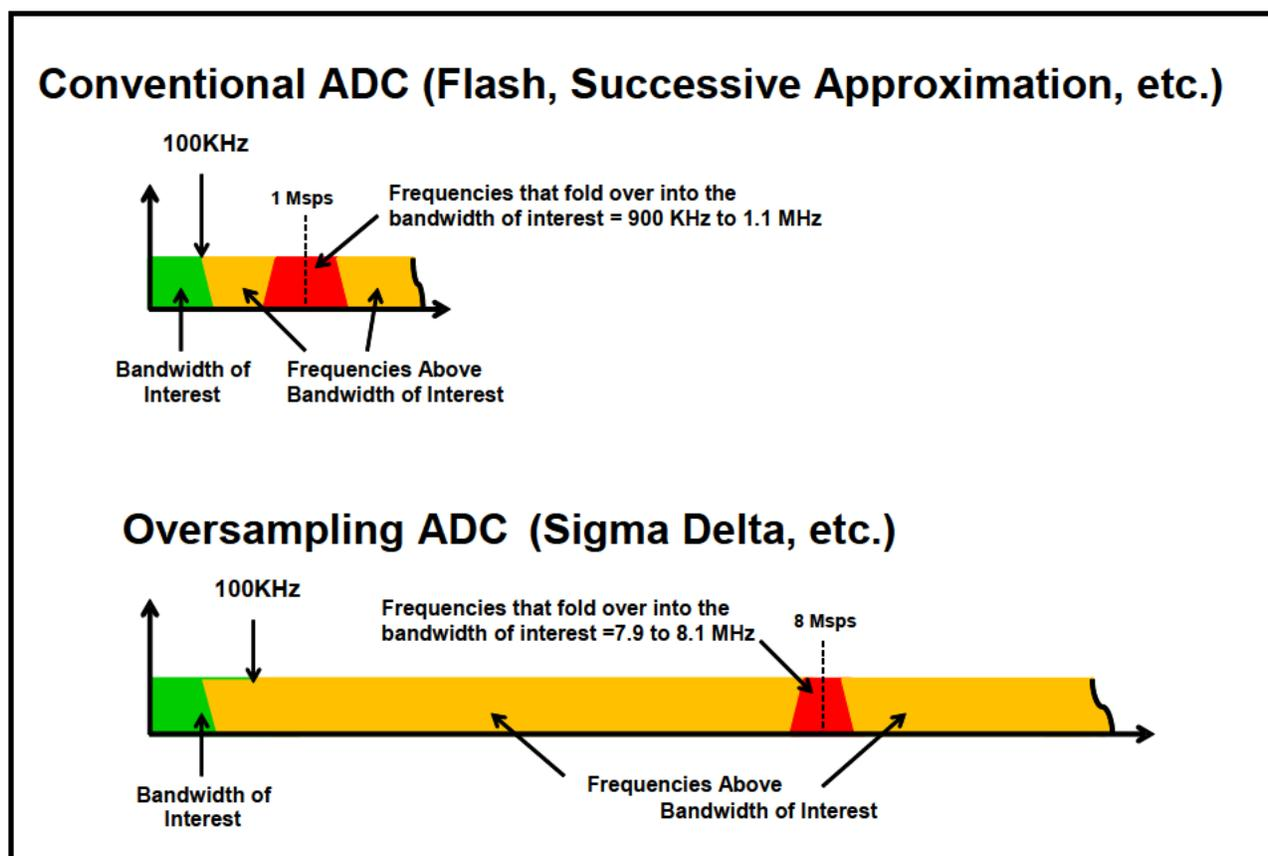


Figure 517.3-8. Illustration of sampling rates and out of band “fold over” frequencies for Conventional and Oversampling (Sigma-Delta) based data acquisition systems.

- d. A noise gage is required for pyroshock measurements because it assists in the identification of anomalies in the data. The noise gage, or inert accelerometer may be purchased from most accelerometer manufacturers. Additionally, the noise gage may also be the same transducer as for other measurement channels and simply suspended near, but not on, the materiel.

MIL-STD-810H
METHOD 517.3

2.3.3 Test Conditions – Shock Spectrum Transient Duration and Scaling.

Derive the SRS and the effective transient duration, T_e , from measurements of the materiel's environment or, if available, from dynamically scaled measurements of a similar environment. Because of the inherent high degree of measurement randomness and limited response prediction methodology associated with the response to a pyroshock, extreme care must be exercised in dynamically scaling a similar event. For pyroshocks, there are two known scaling laws for use with response from pyroshocks that may be helpful if used with care (paragraph 6.1, reference a).

2.3.3.1 Pyroshock Source Energy Scaling (SES).

The first scaling law is the Source Energy Scaling (SES) where the SRS is scaled at all frequencies by the ratio of the total energy release of two different devices. For E_r (reference energy) and E_n (new energy), the total energy in two pyrotechnic shock devices, the relationship between the SRS processed levels at a given natural frequency f_n and distance D_1 is given by the following expression:

$$\text{SRS}(f_n | E_n, D_1) = \text{SRS}(f_n | E_r, D_1) \left(\sqrt{\frac{E_n}{E_r}} \right)$$

In using this relationship, it is assumed that either an increase or decrease in the total energy of the pyrotechnic shock devices will be coupled into the structure in exactly the same way, i.e., excessive energy from a device will go into the structure, as opposed to being dissipated in some other way, e.g., through the air. E_n and E_r may come from physical considerations related to the pyrotechnic device or be computed from ESD estimates (or in the time domain by way of a Parseval-form relationship) where it is assumed that the time history measurements quantify the energy difference. Paragraph 6.1, reference a, discusses conditions under which this scaling law may lead to over-prediction for $E_n > E_r$ or under-prediction when $E_n < E_r$.

2.3.3.2 Pyroshock Response Location Distance Scaling (RLDS).

The second scaling law is the Response Location Distance Scaling (RLDS) where the SRS is scaled at all frequencies by an empirically derived function of the distance between two sources. For D_1 and D_2 , the distances (in meters) from a pyrotechnic shock device (point source), the relationship between the SRS processed levels at a given natural frequency, f_n , is given by the following expression:

$$\text{SRS}(D_2) = \text{SRS}(D_1) \exp \left\{ \left[-8 \times 10^{-4} f_n^{(2.4f_n - 0.105)} \right] (D_2 - D_1) \right\}$$

In using this relationship, it is assumed that D_1 and D_2 can be easily defined as in the case of a pyrotechnic point source device. Figure 517.3-9 from paragraph 6.1, reference a, displays the ratio of $\text{SRS}(f_n|D_2)$ to $\text{SRS}(f_n|D_1)$ as a function of the natural frequency, f_n , for selected values of $D_2 - D_1$. It is clear from this plot that, as the single degree of freedom natural frequency increases, there is a marked decrease in the ratio for a fixed $D_2 - D_1 > 0$ and as $D_2 - D_1$ increases the attenuation becomes substantial. This scaling relationship when used for prediction between two configurations relies very heavily upon (1) similarity of configuration, and (2) the same type of pyrotechnic device. Consult paragraph 6.1, reference a, before applying this scaling relationship.

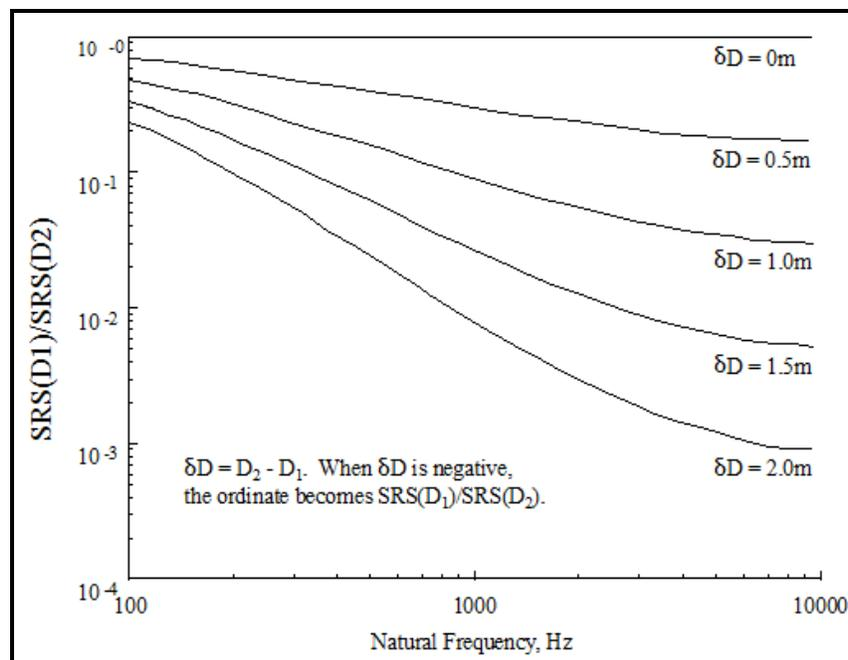
MIL-STD-810H
METHOD 517.3

Figure 517.3-9. Empirical scaling relationship for shock response spectrum as a function of the distance from the pyrotechnic source.

2.3.3.3 Measured Data Available From Pyroshock.

- a. If measured acceleration data are available, the acceleration data shall be validated prior to use. The best indicator of the acceleration data quality is its integral or velocity time history as in paragraph 6.1, references b and d, that shall reflect the physical test configuration that is, in general, zero before and after a pyroshock test. Anomalies in the velocity time history shall be investigated as per paragraph 6.1, references b and d, and their source documented. If the requirements of Paragraph 2.3.2 of this document, were not used to prevent aliasing contamination of the data, then exceptions to these criteria shall be documented and sufficiently justified to prove that digital aliasing of the data has not occurred. Additionally, if all components in the data acquisition system do not have linear phase-shift characteristics in the data passband, and do not have a passband uniform to within one dB across the frequency band of interest, exceptions to these criteria shall be documented and sufficiently justified to prove that data contamination have not occurred.
- b. If measured data are available, the data may be processed using the SRS, FS, or ESD. For engineering and historical purposes, the SRS has become the standard for measured data processing. In the discussion to follow, it will be assumed that the SRS is the processing tool. In general, the maximax SRS spectrum (absolute acceleration or absolute pseudo-velocity) is the main quantity of interest. With this background, determine the shock response spectrum required for the test from analysis of the measured environmental acceleration time history. After carefully qualifying the data, to make certain there are no anomalies in the amplitude time history, according to the recommendations provided in paragraph 6.1, references b and d, compute the SRS. The analysis will be performed for $Q = 10$ at a sequence of natural frequencies at intervals of at least 1/6 octave, and no finer than 1/12th octave spacing to span at least 100 to 20,000 Hz, but not to exceed 100,000 Hz. The frequency range over which the SRS is computed, (i.e., natural frequencies of the SDOF system filters) as a minimum, includes the data signal conditioning bandwidth, but should also extend below and above this bandwidth. In general, the "SRS Natural Frequency Bandwidth" extends from an octave below the lowest frequency of interest, up to a frequency at which the "flat" portion of the SRS spectrum has been reached (that may require going an octave or more above the upper signal conditioning bandwidth). This latter SRS upper frequency, $f_{\text{SRS max}}$, requirement helps ensure no high frequency content in the spectrum is neglected, and is independent of the data bandwidth upper frequency, f_{max} . As a minimum, this SRS upper frequency should exceed f_{max} by at least ten percent, i.e., $1.1f_{\text{max}}$. The lowest frequency of interest is determined by the frequency response characteristics of the mounted materiel under test. Define f_i as the first mounted natural frequency of the materiel (by definition, f_i will be less than or equal to the first

MIL-STD-810H
METHOD 517.3

natural frequency of a materiel component such as a circuit board) and, for laboratory testing purposes, define the lowest frequency of interest as $f_{\min} < f_1/2$ (i.e., f_{\min} is at least one octave below f_1). $f_{\text{SRS min}}$ can then be taken as f_{\min} . The maximax SRS is to be computed over the long time duration and over the frequency range from f_{\min} to $f_{\text{SRS max}} > 1.1 f_{\max}$. When a sufficient number of representative shock spectra are available, employ an appropriate statistical technique (an enveloping technique) to determine the required test spectrum. Annex B of Method 516.8 references the appropriate statistical techniques. Parametric statistics can be employed if the data can be shown to satisfactorily fit an assumed underlying probability distribution. When a normal or lognormal distribution can be justified, Annex B of Method 516.8, and paragraph 6.1, reference l of this Method, references a and l, provide a method for estimating such a test level. Test levels based upon a maximum predicted environment defined to be equal to or greater than the 95th percentile value at least 50 percent of the time uses a one-sided tolerance interval approach.

- c. When insufficient data are available for statistical analysis, use an increase over the maximum of the available spectral data to establish the required test spectrum to account for randomness and inherent variability of the environment. The degree of increase is based upon engineering judgment and is supported by rationale for that judgment. In these cases, it is often convenient to envelope the SRS by computing the maximax spectra over the sample spectra, and proceed to add a +6dB margin to the SRS maximax envelope over the entire frequency range of interest.
- d. When employing the pyroshock method, determine the effective transient duration, T_e , from the measurement time histories of the environmental data as suggested in paragraph 2.3.1. For all procedures, the pyroshock amplitude time history used for the SRS analysis will be T_e in duration. In addition, measurement data for a duration, T_e , shall be collected just prior to the pyroshock, and duration, T_e , just after the pyroshock for subsequent analysis. In general, each individual axis of the three orthogonal axes will have approximately the same shock test SRS and average effective duration as a result of the omni-directional properties of a pyroshock in Procedure I and Procedure II. For Procedures III, IV, and V, the form of shock test SRS may vary with axes. Use an SRS shaker shock replication method when using Procedure V; do not use classical shock pulse forms, e.g., half-sine, terminal-peak saw tooth, etc., in the testing.

2.3.3.4 Measured Data Not Available From Pyroshock.

If a database is not available for a particular configuration, use configuration similarity and any associated measured data for prescribing a pyroshock. Because of the sensitivity of the pyroshock to the system configuration and the wide randomness and variability inherent in pyrotechnic measurements, the tester must proceed with caution. As a basic guide for pyroshock testing, Figure 517.3-10 from paragraph 6.1, reference m, provides SRS estimates for four typical aerospace application pyrotechnic point source devices. Figure 517.3-11 from paragraph 6.1, reference a, provides information on the attenuation of the peaks in the SRS, and of the ramp in the SRS of the point sources on Figure 517.3-10 with distance from the source. Information on Figures 517.3-10 and 517.3-11 come from paragraph 6.1, reference n. This reference also recommends the attenuation of the peak SRS across joints be taken to be 40 percent per joint for up to three joints, and that there be no attenuation of the ramp portion (portion linearly increasing with frequency on the log log plot) of the SRS. Figure 517.3-12 provides the degree of attenuation of the peak amplitude time history response as a function of the shock path distance from the source for seven aerospace structural configurations. This information was summarized from paragraph 6.1, reference o. Either the SES scaling law or the RLDS scaling law may provide guidance. In most cases, either Procedure II or Procedure III are the optimum procedures for testing, with the smallest risk of either substantial undertest or gross overtest, when Procedure I is not an option. Proceed with caution with Procedure II, Procedure III, or Procedure IV, cognizant of the information contained in paragraph 6.1, reference b. Generally, a test transient is deemed suitable if it's SRS equals or exceeds the given SRS requirement over the minimum frequency range of 100 to 20,000 Hz, and the effective transient duration (T) of the test transient is within 20 percent of that of the normal pyroshock response transient duration (T_e). (See paragraph 4.2.2 for test tolerances.)

MIL-STD-810H
METHOD 517.3

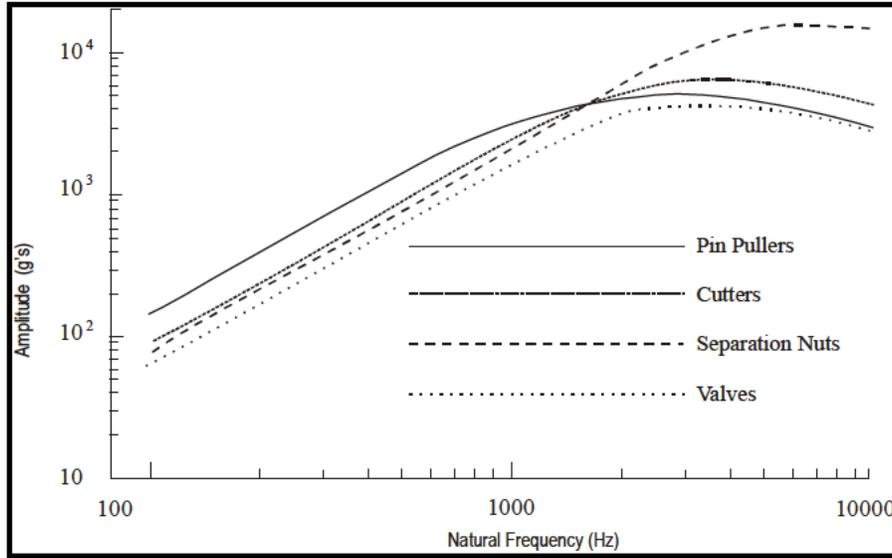


Figure 517.3-10. Shock response spectra for various point source pyrotechnic devices.

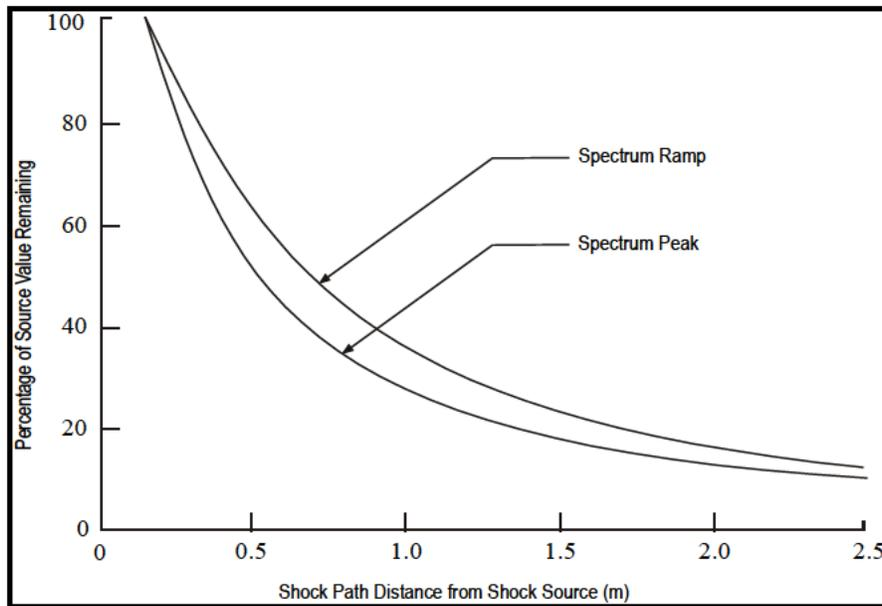


Figure 517.3-11. Shock response spectrum versus distance from pyrotechnic source.

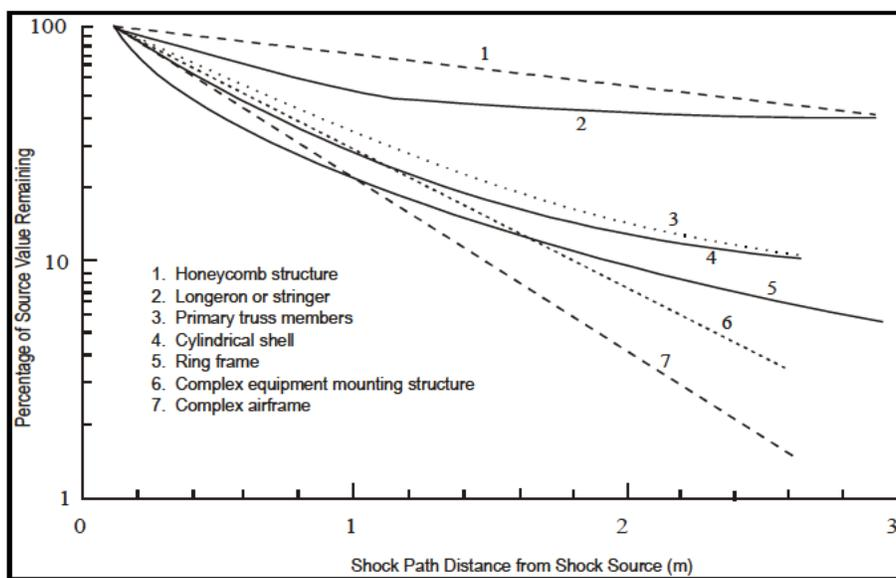
MIL-STD-810H
METHOD 517.3

Figure 517.3-12. Peak pyroshock response versus distance from pyrotechnic source.

2.3.4 Test Axes, Duration, and Number of Shock Events.

2.3.4.1 General.

A suitable test shock for each axis is one that yields an SRS that equals or exceeds the required test SRS over the specified frequency range when using a specified duration for the test shock time history, and when the effective transient duration of the shock (T_e) is within twenty percent of the specified T_e value. For Procedure I, T_e is not specified, but is measured. Properly validate the test data and determine the maximax acceleration SRS for $Q = 10$, and at least at 1/12-octave frequency intervals. The best indicator of the acceleration data quality is its integral or velocity time history as in paragraph 6.1, references b and d, that shall reflect the physical test configuration that is, in general, zero before and after a pyroshock test. Anomalies in the velocity time history shall be investigated as per paragraph 6.1, references b and d, and their source(s) documented. If the requirements of Paragraph 2.3.2 of this document, i.e. an anti-aliasing filter with attenuation as shown in Figure 517.3-7, were not used to prevent aliasing contamination of the data, then exceptions to these criteria shall be documented and sufficiently justified to prove that digital aliasing of the data has not occurred. Additionally, all components in the data acquisition system shall have linear phase-shift characteristics in the data passband, and shall have a passband uniform to within one dB across the frequency band of interest. The following guidelines may also be applied. For materiel that is likely to be exposed once to a given pyroshock event, perform one shock for each appropriate environmental condition. For materiel that is likely to be exposed more frequently to pyroshock events and there are little available data to substantiate the number of pyroshocks, apply three or more at each environmental condition based on the anticipated service use. Application of three or more shocks in one configuration is for enhancement of statistical confidence.

There is a general convention in the evaluation of the pyroshock specifications that a specification with a velocity change of 50 ips or less is mild enough that testing is not required. However, specific programs may require testing for specifications of 50 ips or less if there are components that may be sensitive to even these low velocity changes.

2.3.4.2 Procedure I - Near-field with an Actual Configuration.

For Procedure I, subject the test item to a sufficient number of suitable shocks to meet the specified test conditions or at least three shocks. The objective of the test is to test the physical and functional integrity of the materiel under pyroshock in the near-field of the pyrotechnic device.

2.3.4.3 Procedure II - Near-field with a Simulated Configuration.

For Procedure II, subject the test item to a sufficient number of suitable shocks to meet the specified test conditions or at least three shocks. The measured response test requirements may be satisfied along more than one axis with a single test shock configuration. Consequently, it is conceivable that a minimum of one test shock will satisfy the requirements for all directions of all three orthogonal axes. At the other extreme, a total of three shocks are required

MIL-STD-810H
METHOD 517.3

if each shock only satisfies the test requirements in one direction of one axis. The objective of the test is to test the structural and functional integrity of the materiel under pyroshock in the near-field of the pyrotechnic device.

2.3.4.4 Procedure III - Mid-field with a Mechanical Test Device.

For Procedure III, subject the test item to a sufficient number of suitable shocks to meet the specified test conditions, or at least three shocks. The measured response test requirements may be satisfied along more than one axis with a single test shock configuration. Consequently, it is conceivable that a minimum of three test shock repetitions will satisfy the requirements for all directions of all three orthogonal axes. At the other extreme, a total of nine shocks are required if each shock only satisfies the test requirements in one direction of one axis. The objective of the test is to test the structural and functional integrity of the system under pyroshock in the mid-field of the pyrotechnic device.

2.3.4.5 Procedure IV - Far-field with a Mechanical Test Device.

For Procedure IV, subject the test item to a sufficient number of suitable shocks to meet the specified test conditions or at least three shocks. The measured response test requirements may be satisfied along more than one axis with a single test shock configuration. Consequently, it is conceivable that a minimum of three test shock repetitions will satisfy the requirements for all directions of all three orthogonal axes. At the other extreme, a total of nine shocks are required if each shock only satisfies the test requirements in one direction of one axis. The objective of the test is to test the structural and functional integrity of the system under pyroshock in the far-field of the pyrotechnic device.

2.3.4.6 Procedure V - Far-field with an Electrodynamic Shaker.

For Procedure V, subject the test item to a sufficient number of suitable shocks to meet the specified test conditions, or at least three shocks. The measured response will generally not be omni-directional. For Procedure IV, it may be possible, but highly unlikely, to simultaneously meet the test requirements along more than one axis with a single test shock configuration. Consequently, it is conceivable that a minimum of three test shock repetitions could satisfy the requirements for all directions of all three orthogonal axes. At the other extreme, a total of nine shocks are required if each shock only satisfies the test requirements in one direction of one axis. The objective of the test is to test the structural and functional integrity of the system under pyroshock in the far-field of the pyrotechnic device.

2.4 Test Item Configuration.

See Part One, paragraph 5.8. Configure the test item for pyroshock as would be anticipated for the materiel during service giving particular attention to the details of the mounting of the materiel to the platform. For Procedure II, provide special justification for the selection of the test item configuration. Pyroshock response variation is particularly sensitive to the details of the materiel/platform configuration.

3. INFORMATION REQUIRED.**3.1 Pretest.**

The following information is required to adequately conduct a pyroshock test.

- a. General. Information listed in Part One, paragraphs 5.7 and 5.9, and Part One, Annex A, Task 405 of this Standard.
- b. Specific to this Method.
 - (1) Test system (test item/platform configuration) detailed configuration including:
 - (a) Location of the pyrotechnic device.
 - (b) Location of the materiel.
 - (c) The structural path between the pyrotechnic device and the materiel, and any general coupling configuration of the pyrotechnic device to the platform, and the platform to the materiel including the identification of structural joints.
 - (d) Distance of the closest part of the materiel to the pyrotechnic shock device.
 - (2) Pyroshock environment, including:
 - (a) Type of pyrotechnic device.
 - (b) If charge-related - size of pyrotechnic device charge.

MIL-STD-810H
METHOD 517.3

- (c) If charge effect - stored strain energy in primary device.
- (d) Means of initiation of the pyrotechnic device.
- (e) Anticipated EMI or thermal effects.
- (3) Effective duration of pyroshock if Procedure III, IV, or V is used, or the size and distribution of the pyrotechnic charge if Procedure I or II is used.
- (4) General materiel configuration including measurement points on or near the materiel.
- c. Tailoring. Necessary variations in the basic test procedures to accommodate LCEP requirements and/or facility limitations.

3.2 During Test.

Collect the following information while conducting the test:

- a. General. Information listed in Part One, paragraph 5.10, and in Part One, Annex A, Tasks 405 and 406 of this Standard.
- b. Specific to this Method.
 - (1) A means of assessing any damage to fixture/materiel configurations before continuing the tests. This includes test setup photos, test logs, and plots of actual shock transients. For shock-isolated assemblies within the test item, make measurements and/or inspections to ensure these assemblies did attenuate the pyroshock.
 - (2) A record of previous shock time history information for analysis.
 - (3) An SRS analysis capability to determine if specified pyroshock levels are being replicated.

3.3 Post-Test.

The following post test data shall be included in the test report:

- a. General. Information listed in Part One, paragraph 5.13; and in Annex A, Task 406 of this Standard.
- b. Specific to this Method.
 - (1) Duration of each exposure as recorded by the instrumented test fixture or test item, and the number of specific exposures.
 - (2) Any data measurement anomalies, e.g., high instrumentation noise levels, loss of sensors or sensor mount as a result of testing, etc.
 - (3) Status of the test item/fixture after each test.
 - (4) Status of measurement system after each test.
 - (5) Any deviations from the original test plan.

4. TEST PROCESS.

4.1 Test Facility

Pyroshock can be applied using actual pyrotechnic devices in the design configuration or in a simulated configuration, conventional high acceleration amplitude/frequency test input devices or, under certain restricted circumstances, an electrodynamic shaker. The pyroshock apparatus may incorporate a compressed gas shock tube, metal-on-metal contact, ordnance-generated pyroshock simulator, actual pyrotechnic device on a scale model, actual pyrotechnic device on a full scale model, or other activating types. For Procedure I or Procedure II, references related to ordnance devices must be consulted. For Procedures III and IV, paragraph 6.1, reference b, provides a source of alternative test input devices, their advantages and limitations. In Procedure III it is assumed that all parts of the materiel lie in the mid-field of the pyrotechnic device. Consult paragraph 6.1, reference b, for guidelines and consideration for such testing. For Procedures IV and V, it is assumed that all parts of the materiel lie in the far-field of the pyrotechnic device and the measured or predicted data are consistent with the 3000 Hz frequency definition of the far-field as well

MIL-STD-810H
METHOD 517.3

as the limitations of the electrodynamic shaker in addition to the acceleration amplitude limitations. For large materiel, the velocity input of the shaker may exceed the velocity of the materiel under the actual pyroshock environment. For velocity sensitive materiel, this may constitute an overtest. In the ensuing paragraphs, the portion of the test facility responsible for delivering the pyroshock to the materiel will be termed the "shock apparatus." Such shock apparatus includes the pyrotechnic shock device and the fixturing configuration in Procedures I and II, the mechanical exciter and the fixturing configuration in Procedure III, and the mechanical exciter and electrodynamic shaker and the fixturing configuration in Procedures IV and V.

4.2 Controls.

4.2.1 Calibration.

Ensure the shock apparatus is calibrated for conformance with the specified test requirement from the selected procedure. For Procedure I, there is no pre-shock calibration other than ensuring the configuration is in accordance with the test plan. For Procedure II, before the test item is attached to the resonating plate, it is necessary to attach a calibration load, and obtain measured data under test conditions to be compared with the desired test response. Exercise caution so that the pre-test shocks do not degrade the resonating plate configuration. Calibration is crucial for Procedures III and IV. Before the test item is attached to the shock apparatus, it is necessary to attach a calibration load and obtain measured data under test conditions to be compared with the desired test response. For Procedure V, using the SRS method with proper constraints on the effective duration of the transient, calibration is necessary. Before the test item is attached to the shock apparatus, attach a calibration load, and obtain measured data under test conditions to be compared with the desired test response. Additional tolerances and calibration procedures are provided in Part One, paragraphs 5.2 and 5.3.2, respectively.

4.2.2 Tolerances.

The following are guidelines for test tolerances for pyroshock for the five Procedures. All tolerances are specified on the maximax acceleration SRS. Any tolerances specified on the pseudo-velocity SRS must be derived from the tolerances on the maximax acceleration SRS, and be consistent with those tolerances. For an array of measurements defined in terms of a "zone" (paragraph 6.1, reference e), a tolerance may be specified in terms of an average of the measurements within a "zone." However, this is, in effect, a relaxation of the single measurement tolerance, and that individual measurements may be substantially out of tolerance while the average is within tolerance. In general, when specifying test tolerances based on averaging for more than two measurements within a zone, the tolerance band should not exceed the 95/50 one-sided normal tolerance upper limit computed for the logarithmically transformed SRS estimates, or be less than the mean minus 1.5dB. Any use of "zone" tolerances and averaging must have support documentation prepared by a trained analyst. Additional tolerances and calibration procedures are provided in Part One, paragraphs 5.2 and 5.3.2, respectively.

4.2.2.1 Procedure I - Near-field with an Actual Configuration and Procedure II - Near-field with a Simulated Configuration.

If prior measured data are available, or a series of pyroshocks are performed, all acceleration maximax SRS shall be computed at the center frequency of one-twelfth octave bands. The individual SRS values (points) are to be within - 3 dB to + 6 dB for a minimum of 80 percent of the SRS values in the bandwidth from 100 Hz to 20 kHz. For the remaining 20 percent of the SRS values in the frequency band, the individual SRS values are to be from - 6 dB to + 9 dB. Ensure at least 50 percent of the individual SRS values exceed the nominal test specification.

4.2.2.2 Procedure III- Mid-field with a Mechanical Test Device.

If prior measured data are available, or a series of pyroshocks are performed, all acceleration maximax SRS shall be computed at the center frequency of one-twelfth octave bands. The individual SRS values (points) are to be within - 3 dB to + 6 dB for a minimum of 90 percent of the SRS values in the bandwidth from 100 Hz to 20 kHz. For the remaining 10 percent of the SRS values in the frequency band, the individual SRS values are to be from - 6 dB to + 9 dB. Ensure at least 50 percent of the individual SRS values exceed the nominal test specification.

MIL-STD-810H
METHOD 517.3

4.2.2.3 Procedure IV - Far-field with a Mechanical Test Device.

If prior measured data are available, or a series of pyroshocks are performed, all acceleration maximax SRS shall be computed at the center frequency of one-twelfth octave bands. The individual SRS values (points) are to be within - 3 dB to + 6 dB for a minimum of 90 percent of the SRS values in the bandwidth from 100 Hz to 20 kHz. For the remaining 10 percent of the SRS values in the frequency band, the individual SRS values are to be from - 6 dB to + 9 dB. Ensure at least 50 percent of the individual SRS values exceed the nominal test specification.

4.2.2.4 Procedure V - Far-field with an Electrodynamic Shaker.

If prior measured data are available, or a series of pyroshocks are performed, all acceleration maximax SRS shall be computed at the center frequency of one-twelfth octave bands. The individual SRS values (points) are to be within - 1.5 dB to +3 dB for a minimum of 90 percent of the SRS values in the bandwidth from 10 Hz to 3 kHz. For the remaining 10 percent of the SRS values in the frequency band, the individual SRS values are to be from - 3 dB to + 6 dB. Ensure at least 50 percent of the individual SRS values exceed the nominal test specification.

4.2.3 Instrumentation.

In general, acceleration will be the quantity measured to meet a specification, with care taken to ensure acceleration measurements can be made that provide meaningful data (paragraph 6.1, references b and d). For pyroshock measurements in and close to the near-field, loss of measurement system integrity is not unusual. On occasion, more sophisticated devices may be employed, e.g., laser Doppler vibrometer. In these cases, give special consideration to the measurement instrument amplitude and frequency range specifications in order to satisfy the calibration, measurement and analysis requirements. With regard to measurement technology, accelerometers, strain gages and laser Doppler vibrometers are commonly used devices for measurement. In processing pyroshock data, it is important to be able to detect anomalies. For example, it is well documented that accelerometers may offset or zeroshift during mechanical shock, pyroshock, and ballistic shock (paragraph 6.1, references a, b, t and u). Additional discussion on this topic is found in the ballistic shock method. A part of this detection is the integration of the acceleration amplitude time history to determine if it has the characteristics of a high frequency velocity trace. In addition, instrumentation to measure test item function may be required. In this case, obtain suitable calibration standards and adhere to them. Transducer performance continues to improve with time, however, inventories across all laboratories may not be of the latest generation, and thereby making detailed calibrations critical in understanding individual transducer performance.

a. Accelerometers. Ensure the following:

- (1) Amplitude Linearity: It is desired to have amplitude linearity within 10 percent over the entire operating range of the device. Since accelerometers (mechanically isolated or not) may also show zeroshift (paragraph 6.1, references a, b, t and u), there is risk in not characterizing these devices over their entire amplitude range. To address these possible zeroshifts, high pass filtering (or other data correction technique) may be required. Such additional post-test correction techniques increase the risk of distorting the measured pyroshock environment. Consider the following in transducer selection:
 - (a) It is recognized that accelerometers may have both non-linear amplification and non-linear frequency content below 10,000 Hz (paragraph 6.1, references a, b, t and u). In order to understand the non-linear amplification and frequency characteristics, it is recommended that shock linearity evaluations be conducted at intervals of 20 to 30 percent of the rated amplitude range (inclusive of the maximum rated range) of the accelerometer to identify the actual amplitude and frequency linearity characteristics and useable amplitude and frequency range. Additionally, the shock pulse duration for the evaluations is calculated as:

$$T_D = \frac{1}{2f_{\max}}$$

Where T_D is the duration (baseline) of the acceleration pulse and f_{\max} is the maximum specified frequency range for the accelerometer. For Near-field pyroshock f_{\max} is 100,000 Hz. For Mid-field and

MIL-STD-810H
METHOD 517.3

Far-field pyroshock f_{\max} is 10,000 Hz. If Hopkinson bar testing is used for these evaluations then care must be taken to make sure that a non-dispersive pulse duration is used (paragraph 6.1, reference 5). In absence of techniques for addressing 100,000 Hz characterizations and considering durations limitations associated with non-dispersive reference requirements, a Hopkinson bar (0.75 inch diameter) may be used with a 20 microsecond reference pulse duration, T_D . The roll-off in frequency response of this greater than nominal duration reference must be considered in evaluating linearity. The requirements for shock amplitude and duration are subject to the usual shock tolerance requirements of $\pm 15\%$. In addition, it is recognized that the lower limit for Hopkinson bar testing is usually 5,000 g. Therefore, in order to span the full accelerometer range as defined above, it may be necessary to use more than one calibration apparatus, i.e. a drop ball calibrator as well as a Hopkinson bar.

(b) For cases in which response below 2 Hz is desired, a piezoresistive accelerometer measurement is required.

(2) **Frequency Response:** A flat response within ± 5 percent across the frequency range of interest is required. Since it is generally not practical or cost effective to conduct a series of varying pulse width shock tests to characterize frequency response, a vibration calibration is typically employed. For the case of a high range accelerometer (200,000 g) with low output, there may be SNR issues associated with a low level vibration calibration. In such cases a degree of engineering judgment will be required in the evaluation of frequency response with a revised requirement for flat frequency response to be within ± 1 dB across the frequency range of interest. .

(3) **Accelerometer Sensitivity:** The sensitivity of a shock accelerometer is expected to have some variance over its large amplitude dynamic range.

(a) If the sensitivity is based upon the low amplitude vibration calibration, it is critical that the linearity characteristics of the shock based "Amplitude Linearity" be understood such that an amplitude measurement uncertainty is clearly defined.

(b) Ideally, vibration calibration and shock amplitude linearity results should agree within 10 percent over the amplitude range of interest for a given test.

(4) Transverse sensitivity should be less than or equal to 7 percent.

(5) The measurement device and its mounting will be compatible with the requirements and guidelines provided in paragraph 6.1, reference a.

(6) Unless it is clearly demonstrated that a piezoelectric accelerometer (mechanically isolated or not) can meet the pyroshock requirements and is designed for oscillatory shock (not one-sided shock pulses), recommend piezoresistive accelerometers be used for high intensity, near-field pyroshock events. Piezoresistive or piezoelectric accelerometers may be used in scenarios in which levels are known to be within the established (verified through calibration) operating range of the transducer (mid-field and far-field), thereby avoiding non-linear amplification and frequency content.

b. **Other Measurement Devices.** Ensure any other measurement devices used to collect data are demonstrated to be consistent with the requirements of the test, in particular, the calibration and tolerance information provided in paragraph 4.2.

c. **Signal conditioning.** Use signal conditioning compatible with the instrumentation requirements on the materiel. In particular, filtering will be consistent with the response time history and frequency content requirements. Use signal conditioning compatible with the requirements and guidelines provided in paragraph 6.1, references b and d. In particular, use extreme care in filtering the acceleration signals either (1) directly at the attachment point, i.e., mechanical filtering to reduce the very high frequencies associated with the pyroshock, or (2) at the amplifier output. Never filter the signal into the amplifier for fear of filtering bad measurement data, and the inability to detect the bad measurement data at the amplifier output. The signal from the signal conditioning or recording device must be anti-alias filtered before digitizing with an analog, linear phase shift filter over the frequency range of interest. Use an analog anti-alias filter configuration, other signal conditioning, and the data acquisition system that:

(1) Meets aliasing requirements in Figure 517.3-7.

MIL-STD-810H
METHOD 517.3

- (2) Has phase linearity to within +/- 5° in the data passband.
 - (3) Has a passband uniform to within one dB across the frequency band of interest.
 - (4) Has unit step response with less than 10% (1 dB) overshoot.
- d. Additional Pyroshock Requirements. Additional requirements are necessary for pyroshock measurement, especially near-field and mid-field pyroshock. The requirements of Paragraph 2.3.2 of this document must be used to prevent aliasing contamination of the data. Slew rate specifications are also important because slew rate contamination can alter the low frequency content of the data, and become part of an erroneous specification as per Appendix A of this document. To prevent distortion caused by spurious electrical noise, the data recording instrumentation shall be capable of recording a signal of one half full scale voltage in 1 microsecond without slew rate distortion. For example, if a system is capable of ± 10 volts full scale = 20 volt peak-to-peak, then a slew rate of 10 volt/ μ second is required. Exceptions to these criteria shall be documented and sufficiently justified to prove that aliasing and other contamination of the data has not occurred.

4.2.4 Data Analysis.

- a. Analyze pyroshock data for the extended bandwidth of 10 Hz to 100,000 kHz to examine the low frequencies for data contamination, and to ensure the high frequency content has been captured.
- b. For digital filters used to meet the previous requirement, use a filter with linear phase-shift characteristics and a pass band flatness within one dB across the frequency range specified for the accelerometer (see paragraph 4.2.3).
- c. Ensure the analysis procedures are in accordance with those requirements and guidelines provided in paragraph 6.1, references b and d. In particular, validate the pyroshock acceleration amplitude time histories according to the procedures in paragraph 6.1, reference d. Integrate each amplitude time history to detect any anomalies in the measurement system, e.g., cable breakage, slew rate of amplifier exceeded, data clipped, unexplained accelerometer offset, etc. Compare the integrated amplitude time histories against criteria given in paragraph 6.1, references b and d, and Annex A of this Method. For all Procedures to detect emission from extraneous sources, e.g., EMI, configure an accelerometer as a noise gage (without acceleration sensing element or just another accelerometer that is not attached to the unit under test) and process its response in the same manner as for the other accelerometer measurements. If this noise gage exhibits any characteristic other than very low level noise, consider the acceleration measurements to be contaminated by an unknown noise source in accordance with the guidance in paragraph 6.1, references b and d.

4.3 Test Interruption.

Test interruptions can result from two or more situations, one being from failure or malfunction of test equipment. The second type of test interruption results from failure or malfunction of the test item itself during operational checks.

4.3.1 Interruption Due To Laboratory Equipment Malfunction.

- a. If the test excitation fails to function, refer to local SOPs.
- b. Generally, if the pyroshock device malfunctions or interruption occurs during a mechanical shock pulse, repeat that shock pulse. Care must be taken to ensure stresses induced by the interrupted shock pulse do not invalidate subsequent test results. Inspect the overall integrity of the materiel to ensure pre-shock test materiel structural and functional integrity. Record and analyze data from such interruptions before continuing with the test sequence.

4.3.2 Interruption Due To Test Item Operation Failure.

Failure of the test item(s) to function as required during operational checks presents a situation with two possible options. These decisions are made on a case by case basis, with test item cost and schedule considerations, as well as overall materiel cost and schedule requirements.

- a. The preferable option is to replace the test item with a “new” one and restart from Step 1.
- b. A second option is to replace / repair the failed or non-functioning component or assembly with one that functions as intended, and restart the entire test from Step 1.

MIL-STD-810H
METHOD 517.3

NOTE: When evaluating failure interruptions, consider prior testing on the same test item and consequences of such.

4.4 Test Execution.

4.4.1 Preparation for Test.

4.4.1.1 Preliminary Steps.

Prior to initiating any testing, review pretest information in the test plan to determine test details (e.g., procedures, test item configuration, pyroshock levels, number of pyroshocks):

- a. Choose the appropriate test Procedure.
- b. Determine the appropriate pyroshock levels for the test prior to calibration for Procedures II through V from previously processed data if available, otherwise use the calibration levels.
- c. Ensure the pyroshock signal conditioning and recording devices have adequate amplitude range and frequency bandwidth as per paragraph 4.2.3. It may be difficult to estimate a peak signal and, therefore, the amplitude range for the instrumentation. In general, there is no data recovery from a clipped signal. However, for over-ranged signal conditioning, it is usually possible to get meaningful results for a signal 20 dB above the noise floor of the measurement system. In some cases, redundant measurements may be appropriate - one measurement being over-ranged, and one measurement ranged at the best estimate for the peak signal. The frequency bandwidth of most modern recording devices is usually adequate, but one must make sure that device input filtering does not limit the signal frequency bandwidth.
- d. A noise gage is required for pyroshock measurements. The noise gage or inert accelerometer may be purchased from most accelerometer manufacturers. Additionally, the noise gage may also be the same transducer as for other measurement channels, and simply suspended near, but not on, the structure. In either case, ensure the noise accelerometer has the same signal conditioning as the other accelerometer channels.

4.4.1.2 Pretest Checkout.

All items require a pretest checkout at standard ambient conditions to provide baseline data. Conduct the checkout as follows:

- Step 1 Conduct a complete visual examination of the test item with special attention to micro-electronic circuitry areas. Pay particular attention to its platform mounting configuration and potential stress wave transmission paths.
- Step 2 Document the results.
- Step 3 Where applicable, install the test item in its test fixture.
- Step 4 Conduct an operational checkout in accordance with the approved test plan along with simple tests for ensuring the measurement system is responding properly.
- Step 5 Document the results for comparison with data taken during and after the test.
- Step 6 If the test item operates satisfactorily, proceed to Step 7. If not, resolve the problem and restart at Step 1.
- Step 7 Remove the test item and proceed with the calibration (except for Procedure I).

4.4.2 Test Procedures.

The following procedures provide the basis for collecting the necessary information concerning the platform and test item under pyroshock.

MIL-STD-810H
METHOD 517.3**4.4.2.1 Procedure I - Near-field with an Actual Configuration.**

- Step 1 Following the guidance of paragraph 6.1, reference b, select the test conditions and mount the test item (in general there will be no calibration when actual hardware is used in this procedure). Select accelerometers and analysis techniques that meet the criteria outlined in this Method.
- Step 2 Subject the test item (in its operational mode) to the test transient by way of the pyrotechnic test device.
- Step 3 Record necessary data that show the shock transients, when processed with the SRS algorithm, are within specified tolerances.
- Step 4 Perform an operational check of the test item. Record performance data. If the test item fails to operate as intended, follow the guidance in paragraph 4.3 for test item failure.
- Step 5 If the integrity of the test configuration can be preserved during test, repeat Steps 2, 3, and 4 a minimum of three times for statistical confidence. Otherwise proceed to Step 6.
- Step 6 Document the test series, and see paragraph 5 for analysis of results.

4.4.2.2 Procedure II - Near-field with Simulated Configuration.

- Step 1 Following the guidance in this Method, select test conditions and calibrate the shock apparatus as follows:
 - a. Select accelerometers and analysis techniques that meet the criteria outlined in this Method.
 - b. Mount the calibration load (an actual test item, a rejected item, or a rigid dummy mass) to the test apparatus in a manner similar to that of the actual materiel service mount. If the materiel is normally mounted on shock isolators to attenuate the pyroshock, ensure the isolators are functional during the test.
 - c. Perform calibration shocks until two consecutive shock applications to the calibration load produce shock transients that, when processed with the SRS algorithm, are within specified tolerances for at least one direction of one axis.
 - d. Remove the calibrating load and install the actual test item on the shock apparatus, paying close attention to mounting details.
- Step 2 Subject the test item (in its operational mode) to the test pyroshock.
- Step 3 Record necessary data that show the shock transients, when processed with the SRS algorithm, are within specified tolerances. If requirements are given in terms of more than one axis, examine responses in the other axes to ensure the test specification has been met. This includes test setup photos, test logs, and photographs of actual shock transients. For shock isolated assemblies within the test item, make measurements and/or inspections to assure the isolators attenuated the pyroshock.
- Step 4 Conduct an operational check of the test item. Record performance data. If the test item fails to operate as intended, follow the guidance in paragraph 4.3.2 for test item failure.
- Step 5 Repeat Steps 1 through 4 for each orthogonal axis that is to be tested unless the test shock meets the test specification in more than one axis at a time. Repeat steps 1 through 4 as necessary to demonstrate the test specification has been met in all three axes.
- Step 6 Document the test series, and see paragraph 5 for analysis of results.

4.4.2.3 Procedure III - Mid-field Using Mechanical Test Device.

- Step 1 Following the guidance of this Method, select test conditions and calibrate the shock apparatus as follows:
 - a. Select accelerometers and analysis techniques that meet the criteria outlined in this Method.
 - b. Mount the calibration load (an actual test item, a rejected item, or a rigid dummy mass) to the test apparatus in a manner similar to that of the actual materiel service mount. If the materiel is

MIL-STD-810H
METHOD 517.3

normally mounted on shock isolators to attenuate the pyroshock, ensure the isolators are functional during the test.

c. Perform calibration shocks until two consecutive shock applications to the calibration load produce waveforms that, when processed with the SRS algorithm, are within specified tolerances for at least one axis.

d. Remove the calibrating load and install the actual test item on the shock apparatus paying close attention to mounting details.

- Step 2 Subject the test item (in its operational mode) to the test pyroshock.
- Step 3 Record necessary data that show the shock transients when processed with the SRS algorithm are within specified tolerances. If requirements are given in terms of more than one axis, examine responses in the other axes to ensure the test specification has been met. This includes test setup photos, test logs, and photos of actual shock transients. For shock isolated assemblies within the test item, make measurements and/or inspections to assure the isolators attenuated the pyroshock.
- Step 4 Conduct an operational check of the test item. Record performance data. If the test item fails to operate as intended, follow the guidance in paragraph 4.3.2 for test item failure.
- Step 5 Repeat Steps 1 through 5 for each orthogonal axis that is to be tested unless the test shock meets the test specification in more than one axis at a time. Repeat steps 1 through 5 as necessary to demonstrate the test specification has been met in all three axes.
- Step 6 Document the tests, and see paragraph 5 for analysis of results.

4.4.2.4 Procedure IV - Far-field Using Mechanical Test Device.

- Step 1 Following the guidance of this Method, select test conditions and calibrate the shock apparatus as follows:
- a. Select accelerometers and analysis techniques that meet the criteria outlined in paragraph 6.1, reference d.
 - b. Mount the calibration load (an actual test item, a rejected item, or a rigid dummy mass) to the test apparatus in a manner similar to that of the actual materiel service mount. If the materiel is normally mounted on shock isolators to attenuate the pyroshock, ensure the isolators are functional during the test.
 - c. Perform calibration shocks until two consecutive shock applications to the calibration load produce waveforms that, when processed with the SRS algorithm, are within specified tolerances for at least one direction of one axis.
 - d. Remove the calibrating load and install the actual test item on the shock apparatus paying close attention to mounting details.
- Step 2 Subject the test item (in its operational mode) to the test pyroshock.
- Step 3 Record necessary data that show the shock transients when processed with the SRS algorithm are within specified tolerances. If requirements are given in terms of more than one axis, examine responses in the other axes to ensure the test specification has been met. This includes test setup photos, test logs, and photos of actual shock transients. For shock isolated assemblies within the test item, make measurements and/or inspections to assure the isolators attenuated the pyroshock. If they do not, either replace the shock isolation or redesign it.
- Step 4 Conduct an operational check of the test item. Record performance data. If the test item fails to operate as intended, follow the guidance in paragraph 4.3.2 for test item failure.
- Step 5 Repeat Steps 1 through 4 for each orthogonal axis that is to be tested unless the test shock meets the test specification in more than one axis at a time. Repeat steps 1 through 4 as necessary to demonstrate the test specification has been met in all three axes.
- Step 6 Document the tests, and see paragraph 5 for analysis of results.

MIL-STD-810H
METHOD 517.3

4.4.2.5 Procedure V - Far-field Using Electrodynamic Shaker.

- Step 1 Following the guidance of this Method, select test conditions and calibrate the shock apparatus as follows:
- a. Select accelerometers and analysis techniques that meet the criteria outlined in paragraph 6.1, reference d.
 - b. Mount the calibration load (an actual test item, a rejected item, or a rigid dummy mass) to the electrodynamic shaker in a manner similar to that of the actual materiel. If the materiel is normally mounted on shock isolators to attenuate the pyroshock, ensure the isolators are functional during the test.
 - c. Develop the SRS wavelet or damped sine compensated amplitude time history based on the required test SRS.
 - d. Perform calibration shocks until two consecutive shock applications to the calibration load produce shock transients that, when processed with the SRS algorithm, are within specified test tolerances for at least one direction of one axis. If not within tolerances, determine the problem and correct it as necessary.
 - e. Remove the calibration load and install the actual test item on the electrodynamic shaker, paying close attention to mounting details.
- Step 2 Subject the test item (in its operational mode) to the test electrodynamic pyroshock simulation.
- Step 3 Record necessary data that show the shock transients, when processed with the SRS algorithm, are within specified tolerances. If requirements are given in terms of more than one axis, examine responses in the other axes to ensure the test specification has been met. This includes test setup photos, test logs, and photos of actual shock transients. For shock isolated assemblies within the test item, make measurements and/or inspections to assure the isolators attenuated the pyroshock.
- Step 4 Conduct an operational check on the test item. Record performance data. If the test item fails to operate as intended, follow the guidance in paragraph 4.3.2 for test item failure.
- Step 5 Repeat Steps 1 through 4 for each orthogonal axis that is to be tested unless the test shock meets the test specification in more than one axis at a time. Repeat steps 1 through 4 as necessary to demonstrate the test specification has been met in all three axes.
- Step 6 Document the tests, and see paragraph 5 for analysis of results.

5. ANALYSIS OF RESULTS.

In addition to the guidance provided in Part One, paragraphs 5.14 and 5.17; and Part One, Annex A, Task 406, the following information is provided to assist in the evaluation of the test results. Analyze in detail any failure of a test item to meet the requirements of the system specifications, and consider related information such as:

5.1 Procedure I - Near-field with Actual Configuration.

Carefully evaluate any failure in the structural configuration of the test item, e.g., minute cracks in circuit boards that may not directly impact failure of the functioning of the materiel, but that would lead to failure in its in-service environment conditions. Once the source of the failure is identified, re-testing is required.

5.2 Procedure II - Near-field with Simulated Configuration.

Carefully evaluate any failure in the structural configuration of the test item, e.g., minute cracks in circuit boards that may not directly impact failure of the functioning of the materiel, but that would lead to failure in its in-service environment conditions. Once the source of the failure is identified, re-testing is required.

5.3 Procedure III - Mid-field Using Mechanical Test Device.

The mechanical shock simulation will, in general, provide a more severe low frequency environment (comparatively large velocity and displacement) than the actual pyroshock event and, hence, any structural failures, e.g., deformed fasteners or mounts, may be more akin to those found in the SRS prescribed shock tests described in Method 516.8.

MIL-STD-810H
METHOD 517.3

If this is the case, and the cause of the structural failure is not readily apparent, another procedure may be required to satisfy the test requirements. Once the source of the failure is identified, re-testing is required.

5.4 Procedure IV - Far-field Using Mechanical Test Device.

The mechanical shock simulation will, in general, provide a more severe low frequency environment (comparatively large velocity and displacement) than the actual pyroshock event and, hence, any structural failures, e.g., deformed fasteners or mounts, may be more akin to those found in the SRS prescribed shock tests described in Method 516.8. If this is the case and the cause of the structural failure is not readily apparent, another procedure may be required to satisfy the test requirements. Once the source of the failure is identified, re-testing is required.

5.5 Procedure V - Far-field Using Electrodynamical Shaker.

The mechanical shock simulation will, in general, provide a more severe low frequency environment (comparatively large velocity) than the actual pyroshock event and, hence, any structural failures may be more akin to those found in the SRS prescribed shock tests described in Method 516.8. If this is the case and the cause of the structural failure is not readily apparent, another procedure may be required to satisfy the test requirements. Once the source of the failure is identified, re-testing is required.

6. REFERENCE/RELATED DOCUMENTS.

6.1 Referenced Documents.

- a. "Pyroshock Test Criteria," NASA Technical Standard, NASA-STD-7003A, December 20, 2011.
- b. Recommended Practice for Pyroshock Testing, IEST-RP-DTE032.2, Institute of Environmental Sciences and Technology, Arlington Place One, 2340 S. Arlington Heights Road, Suite 100, Arlington Heights, IL 60005-4516.
- c. MIL-STD-331, "Fuze and Fuze Components, Environmental and Performance Tests for".
- d. Handbook for Dynamic Data Acquisition and Analysis, IEST-RD-DTE012.2, Institute of Environmental Sciences and Technology, Arlington Place One, 2340 S. Arlington Heights Road, Suite 100, Arlington Heights, IL 60005-4516.
- e. Scavuzzo, Rudolph J. and Henry C. Pusey, Principles and Techniques of Shock Data Analysis, 2nd Edition, The Shock and Vibration Information Center, SVM-16, Shock & Vibration Information Exchange (SAVE), 1104 Arvon Rd, Arvon, VA 23004.
- f. Shock and Vibration Handbook, Sixth Edition, Edited by Piersol, Allan G. and Paez, Thomas L.; McGraw-Hill Book Company, 2010.
- g. Gaberson, H. A. and R. H. Chalmers. Modal Velocity as a Criterion of Shock Severity, Shock and Vibration Bulletin 40, Pt. 2, (1969) 31-49; Shock & Vibration Information Exchange (SAVE), 1104 Arvon Rd, Arvon, VA 23004.
- h. Gaberson, H. A., and R. H. Chalmers. Reasons for Presenting Shock Spectra with Velocity as the Ordinate, Proceedings of the 66th Shock and Vibration Symposium., Vol. II, pp 181-191, Oct/Nov. 1995; Shock & Vibration Information Exchange (SAVE), 1104 Arvon Rd, Arvon, VA 23004.
- i. Smallwood, David O., Characterization and Simulation of Transient Vibrations Using Band Limited Temporal Moments, Shock and Vibration Journal, Volume 1, Issue 6, 1994, pp 507-527; Shock & Vibration Information Exchange (SAVE), 1104 Arvon Rd, Arvon, VA 23004.
- j. Merritt, Ronald G., A Note on Transient Vibration Model Detection, IES Proceedings of the 42nd ATM 1995, Institute of Environmental Sciences and Technology, Arlington Place One, 2340 S. Arlington Heights Road, Suite 100, Arlington Heights, IL 60005-4516.
- k. Newland, D. E., An Introduction to Random Vibrations, Spectral & Wavelet Analysis, John Wiley & Sons, Inc., New York 1995.
- l. Piersol, Allan G., Procedures to Compute Maximum Structural Responses from Predictions or Measurements at Selected Points, Shock and Vibration Journal, Vol 3, Issue 3, 1996, pp 211-221, Shock & Vibration Information Exchange (SAVE), 1104 Arvon Rd, Arvon, VA 23004.

MIL-STD-810H
METHOD 517.3

- m. Himelblau, Harry, Dennis L. Kern, Allan G. Piersol, Jerome E. Manning, and Sheldon Rubin, Guidelines for Dynamic Environmental Criteria, NASA-HDBK-7005, Jet Propulsion Laboratory, California Institute of Technology, March 13, 2001.
- n. Barrett, S., The Development of Pyro Shock Test Requirements for Viking Lander Capsule Components, Proceedings of the 21st ATM, Institute of Environmental Sciences, pp 5-10, Apr. 1975. Institute of Environmental Sciences and Technology, Arlington Place One, 2340 S. Arlington Heights Road, Suite 100, Arlington Heights, IL 60005-4516.
- o. Kacena, W. J., McGrath, M. B., and Rader, W. P., Aerospace Systems Pyrotechnic Shock Data, NASA CR-116437, -116450, -116401, -116402, -116403, -116406, and -116019, Vol. I-VII, 1970.
- p. Edwards, T., "Effects of Aliasing on Numerical Integration", Mechanical System and Signal Processing, Vol. 21, pp. 165-176, Elsevier, 2007.
- q. Bateman, V. I., "Sources of Corrupted Pyroshock Data", Proceedings of the 80th Shock and Vibration Symposium, San Diego, CA, October, 2009.
- r. Remelman, G. M., "Gunfire Measurements with Broadband Triaxial Piezoresistive Accelerometers", Proceedings of the 81st Shock and Vibration Symposium, Orlando, FL, October 2010.
- s. Bateman, V. I., H. Himelblau, and R. Merritt, "Validation of Pyroshock", 81st Shock and Vibration Symposium, October 2010.
- t. Chu, A., "Zeroshift of Piezoelectric Accelerometers in Pyroshock Measurements," Proceedings of the 58th Shock & Vibration Symposium, Huntsville, AL, October 1987.
- u. Plumlee, R. H., "Zero-Shift in Piezoelectric Accelerometers," Sandia National Laboratories Research Report, SC-RR-70-755, March 1971.
- v. Bateman, V. I., "Accelerometer Isolation for Mechanical Shock and Pyroshock," Proceedings of the 82nd Shock and Vibration Symposium, Baltimore, MD, November, 2011 (paper) and ESTECH2012, Orlando, FL, May 2012.
- w. Bateman V. I., F. A. Brown, and M. A. Nusser, "High Shock, High Frequency Characteristics of a Mechanical Isolator for a Piezoresistive Accelerometer, the ENDEVCO 7270AM6," SAND00-1528, National Technical Information Service, 5285 Port Royal Road, Springfield, VA 22162, July 2000 (GOOGLE: SAND00-1528).
- x. ISO Secondary Shock Calibration Standard (ISO/NP 16063-22:2005) "Methods for the calibration of vibration and shock transducers – Part 22: Shock calibration by comparison to a reference transducer" and approved for revision October 2013, as per ISO documents N573, Resolution 3, and N570 available from ANSI. Revised version is TBP by ISO.

6.2 Related Documents.

- a. Allied Environmental Conditions and Test Publication (AECTP) 400, Mechanical Environmental Tests (under STANAG 4370), Method 415.
- b. Egbert, Herbert W. "The History and Rationale of MIL-STD-810 (Edition 2)," January 2010; Institute of Environmental Sciences and Technology, Arlington Place One, 2340 S. Arlington Heights Road, Suite 100, Arlington Heights, IL 60005-4516.

(Copies of Department of Defense Specifications, Standards, and Handbooks, and International Standardization Agreements are available online at <https://assist.dla.mil>.)

Requests for other defense-related technical publications may be directed to the Defense Technical Information Center (DTIC), ATTN: DTIC-BR, Suite 0944, 8725 John J. Kingman Road, Fort Belvoir VA 22060-6218, 1-800-225-3842 (Assistance--selection 3, option 2), <http://www.dtic.mil/dtic/>; and the National Technical Information Service (NTIS), Springfield VA 22161, 1-800-553-NTIS (6847), <http://www.ntis.gov/>.

MIL-STD-810H
METHOD 517.3 ANNEX A**METHOD 517.3, ANNEX A****GUIDELINES FOR ADDITIONAL PYROSHOCK TIME HISTORY VALIDATION AND PROCESSING****1. INTRODUCTION.**

This Annex provides additional guidelines for pyroshock time history assessment including validation, i.e., to detect any measurement system anomalies that would invalidate the measurement. For massive field shock measurement programs where time and budget constraints do not allow validation of individual pyroshocks, at least one pyroshock time history from the near-field, mid-field, and far-field must be individually validated, and careful examination of the time history for each subsequent shock from the measurement channel be examined for gross anomalies. Consistency relative to the test specification for processed information is acceptable as long as any inconsistency is investigated under pyroshock time history validation. The best indicator of pyroshock accelerometer data quality is the integral or velocity time history. As the examples below show, many anomalies in the accelerometer data cannot be detected from the acceleration plot or the shock response spectrum (SRS), especially if the SRS is only plotted down to 100 Hz.

The sources of pyroshock data contamination have been known for some time (more than 20 years): electromagnetic noise (or other noise sources), digital aliasing, and offsets in the data. Electromagnetic noise is always a potential problem with pyroshock testing, especially when explosives are detonated. The high frequency electromagnetic pulse can be eliminated in some cases, but in many cases, the electromagnetic pulse creates an additional environment that can cause invalid data contaminated by the inadequate response to the pulse by the signal conditioner and/or data acquisition system (DAS). The cause of digital data aliasing is, but not limited to, inadequate analog filtering prior to digitization and inadequate bandwidth of the DAS. Offsets in the acceleration data are generally caused by accelerometer malfunction and, in some cases, DAS problems such as inadequate slew rate capability as shown below.

2. ALIASED DATA.

The data shown in Figure 517.3A-1 are a complex shock that starts with a near-field pyroshock followed by two mechanical shock events as shown in paragraph 6.1, reference r. The accelerometer used to measure these data is a piezoresistive type. These data were sampled at 25,000 Hz, and taken with a data acquisition system (DAS) that has an "anti-aliasing Bessel filter" that is - 3 dB at a 20,000 Hz cutoff frequency, as per manufacturer's specifications. This specification means that the filter attenuation is only 80 dB down in a decade (200,000 Hz), and that the data are severely aliased. For example, the sample rate of 25,000 Hz gives a Nyquist frequency (highest frequency that can be resolved at the given sample rate) of 12,500 Hz. Consequently, the anti-aliasing filter provides no protection at all at this sample rate, or even at the higher sample rates of up to 100,000 Hz. The recommended practice for pyroshock data is an anti-aliasing filter that is 60 dB/octave, and the cutoff frequency should be at least one octave below the Nyquist frequency as per paragraph 6.1, references b, d, and f. The requirements of Paragraph 2.3.2 of this document are an equivalent way to achieve the same aliasing protection with more flexibility in other data parameters. Additionally, the recommended practice is to sample at least ten times higher than the desired bandwidth of the measurement in order to achieve 5% or less amplitude error as per paragraph 6.1, references b, d, and f.

The integral of the data shown in Figure 517.3A-1 is in Figure 517.3A-2. The velocity should start and end at zero because the materiel on which the data were taken starts in a stationary position, and is in that same position at the end of the complex shock. However, the velocity time history clearly shows the characteristics of aliasing as per paragraph 6.1, reference p.

MIL-STD-810H
METHOD 517.3 ANNEX A

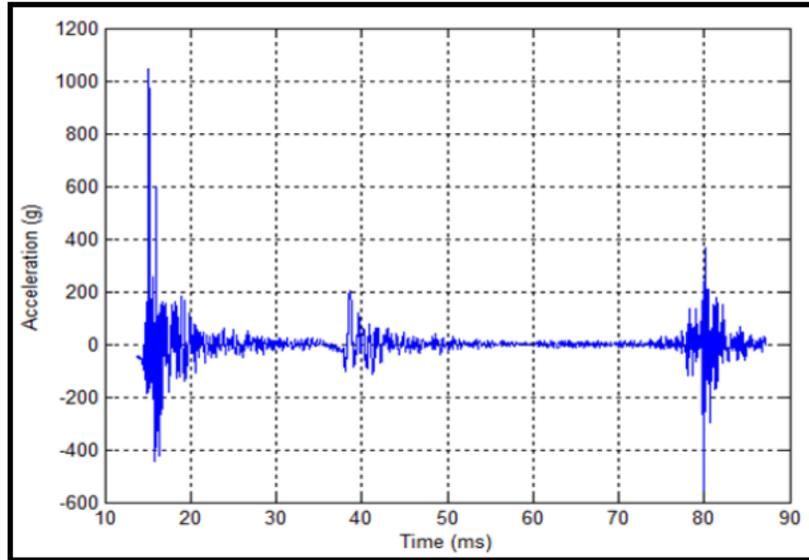


Figure 517.3A-1. A near-field pyroshock followed by two mechanical shock events.

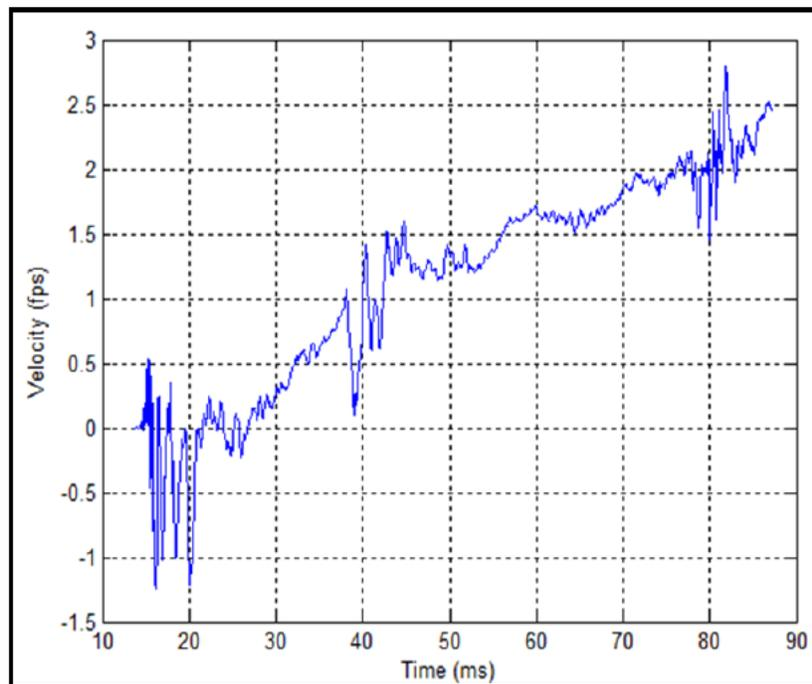


Figure 517.3A-2. The integral of the acceleration data in Figure 517.3A-1.

The discrete Fourier transform in Figure 517.3A-3 shows additional verification of the aliasing problem. An anti-aliasing filter with 60 dB/octave attenuation has 10 decade/decade slope on a log-log plot. Clearly the discrete Fourier transform in Figure 517.3A-3 does not have this attenuation and even starts to increase as it approaches the Nyquist frequency, an additional indication of aliasing. The positive and negative shock response spectra (SRS) are shown in Figure 517.3A-4.

MIL-STD-810H
METHOD 517.3 ANNEX A

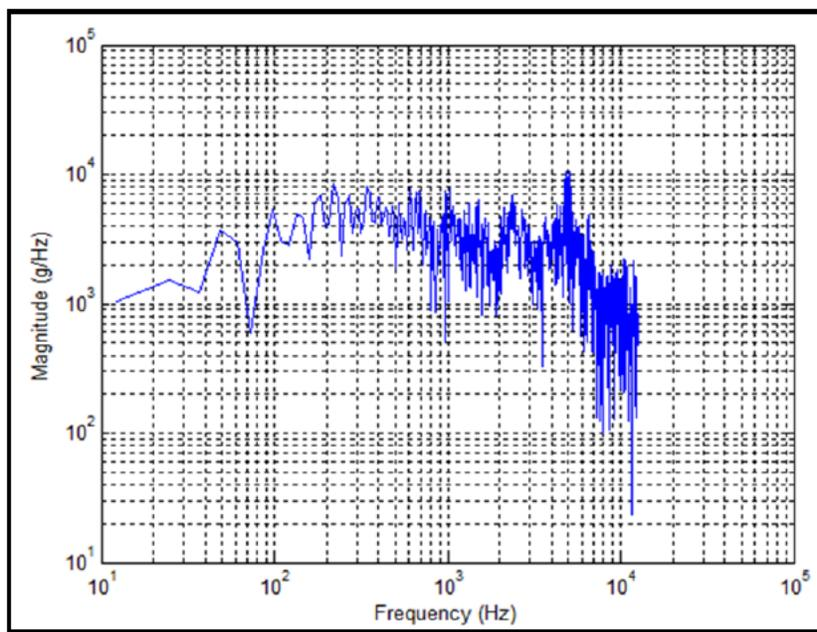


Figure 517.3A-3. Discrete Fourier transform of the data in Figure 517.3A-1.

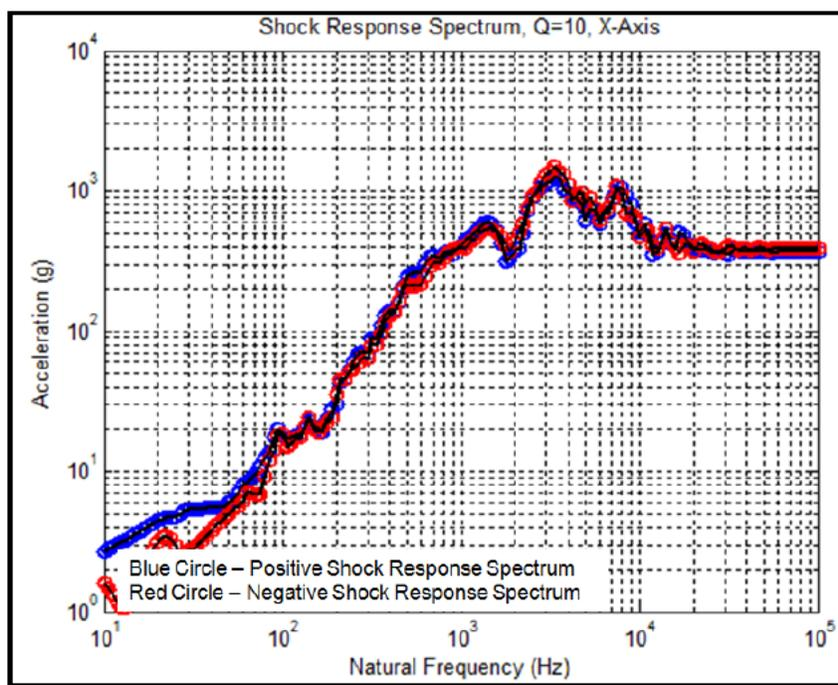


Figure 517.3A-4. The shock response spectra of the acceleration data in Figure 517.3A-1 ($Q=10$).

These two SRS are plausible, especially if the SRS is not plotted below 100 Hz. Additionally, the positive and negative SRS show agreement that indicates good pyroshock data. In summary, the problems with these data are: inadequate sample rate, inadequate anti-aliasing filter, and inadequate zero time before and after the complex shock. The problems can be assessed by an inspection of the accelerometer and DAS specifications. However, these are problems that cannot be detected by examination of the acceleration time history and the SRS alone and emphasize the importance of integrating the acceleration time history as per paragraph 6.1, references b and d.

MIL-STD-810H
METHOD 517.3 ANNEX A**3. SLEW RATE CONTAMINATED DATA.**

These near-field data were recorded at a government facility that routinely conducts pyroshock testing. Triaxial accelerometer data were recorded during the firing of explosives located on a steel plate, but only the in-axis accelerometer data (data sensing the strongest response) are discussed and analyzed as per paragraph 6.1, references q and s. The raw in-axis accelerometer data are shown in Figure 517.3A-5 and appear to have the general characteristics of near-field pyroshock data. The data are very symmetrical visually. The integral of the accelerometer data is shown in Figure 517.3A-6 and indicates a velocity change that is inconsistent (and therefore erroneous) with a pyrotechnic test that has a zero velocity change.

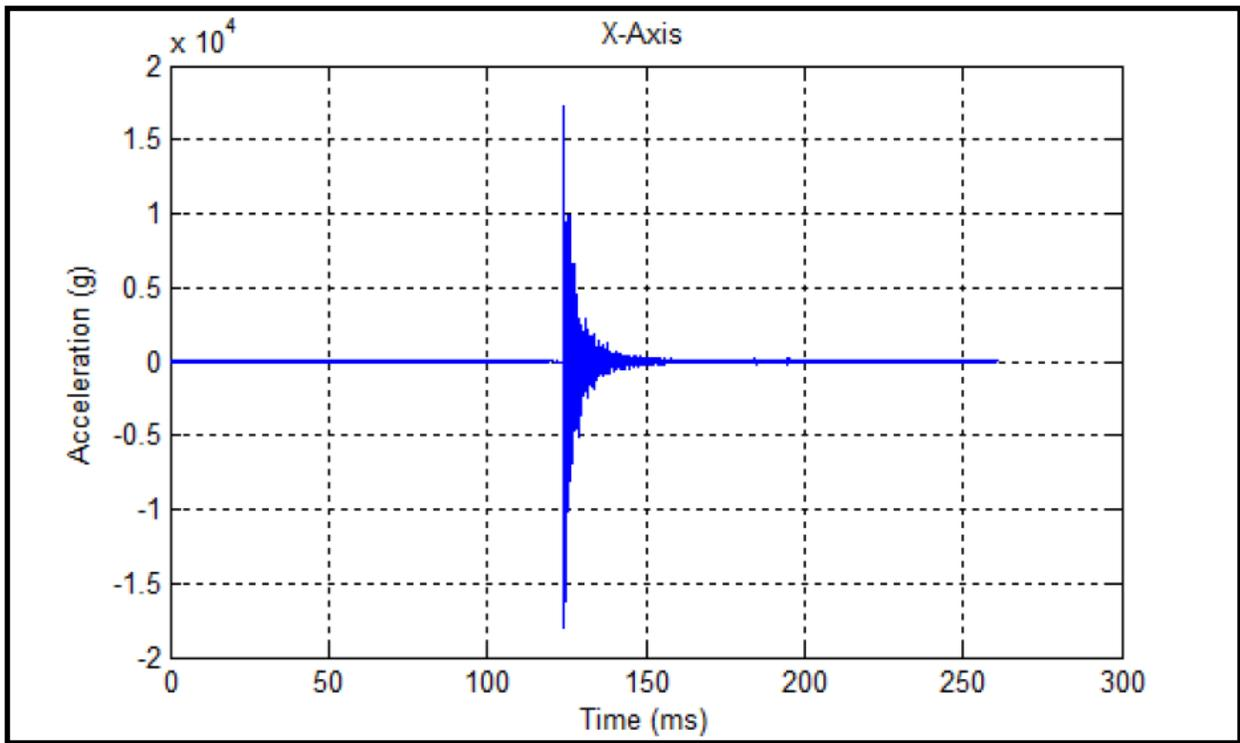


Figure 517.3A-5. A near-field pyroshock acceleration time history.

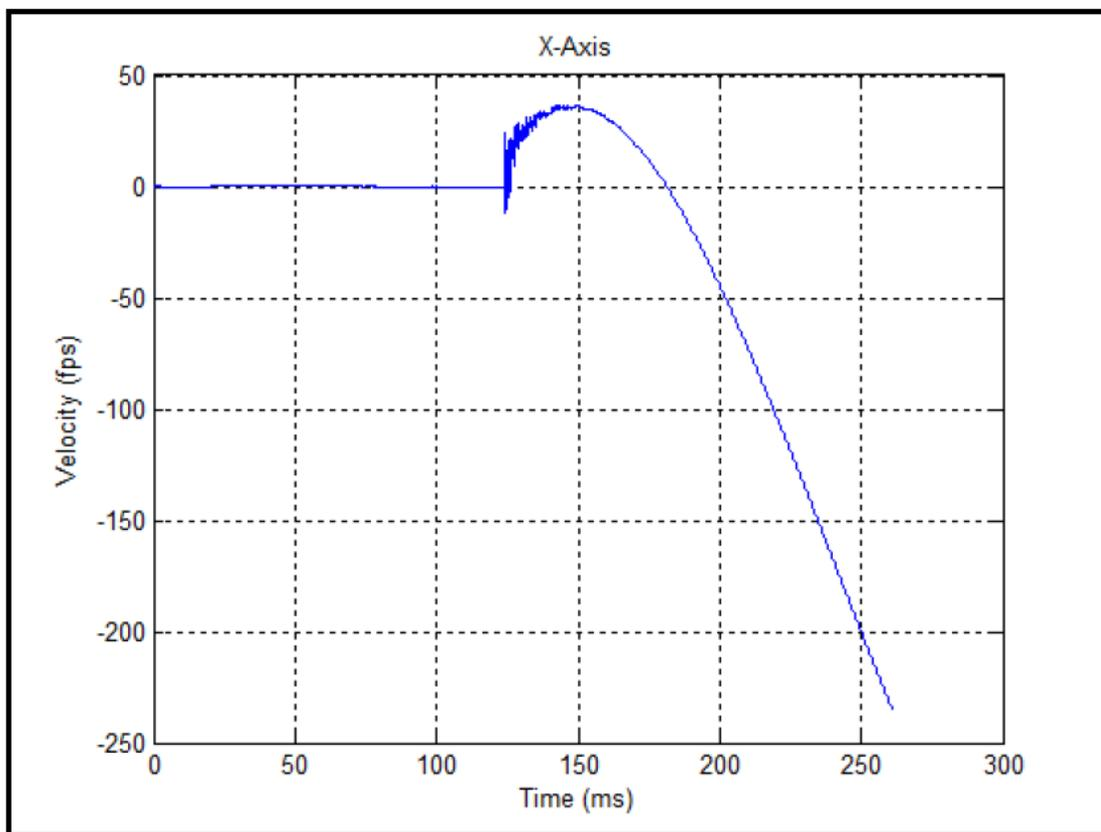
MIL-STD-810H
METHOD 517.3 ANNEX A

Figure 517.3A-6. The integral of the acceleration data in Figure 517.3A-5.

There is significant frequency content above 10,000 Hz at magnitudes above 10,000 g as evidenced by the discrete Fourier transform (DFT) in Figure 517.3A-7 and the shock response spectrum (SRS) in Figure 517.3A-8. The data were taken with hardware frequently used for pyroshock: a piezoelectric (PE) accelerometer with an internal mechanical low-pass filter and an internal electrical low-pass filter, a signal conditioner with 20,000 Hz cutoff frequency, a 4-pole Butterworth, low-pass “anti-aliasing” filter, and a data acquisition system (DAS) with sigma-delta architecture. Both the accelerometer and the signal conditioner are manufactured by the same company, and the DAS is manufactured by a second company. It is clear from DAS specifications that the anti-aliasing is inadequate, Figure 517.3A-7 shows that the roll-off of the data is not 60 dB/octave or 10 decade/decade slope on a log-log plot as per paragraph 6.1, references b, d, and f and indicates that aliasing is possible. In this case, the problems with the SRS start substantially above 100 Hz as shown in Figure 517.3A-8. A wavelet analysis was performed on these data as per paragraph 6.1, reference q, and the erroneous part of the data removed with this analysis is shown in Figure 517.3A-9 that has a magnitude of +800/-500 g or about 4% of the amplitude in Figure 517.3A-5 and has a highly oscillatory time history that is the response to the combined environment of pyroshock acceleration and noise by either the signal conditioner, the associated DAS, or both. The two characteristics of slew-rate problems are present in Figure 517.3A-9: low-frequency modulation (800 Hz as shown in the SRS) and an offset. A direct comparison of the two SRS for Figure 517.3A-5 and Figure 517.3A-9 is made in Figure 517.3A-10, and the curves directly overlay each other up to a frequency of 800 Hz, depicting the low-frequency contamination. Also, Figure 517.3A-12 shows that the upper-frequency limit of the wavelet correction is 800 Hz and does not change the high-frequency content above 800 Hz that is crucial to creating an accurate pyroshock specification from the SRS. What was assumed to be a structural response in the original SRS of Figure 517.3A-8 is now revealed as a DAS slew rate limitation.

SRS comparison of the erroneous data and the original data are in Figure 517.3A-10 and show the contaminated data are the cause for the erroneous SRS in Figure 517.3A-8. The contamination occurs at a frequency of 800 Hz and below. However, if just the high frequency positive and negative shock response spectra are examined, then the data looks reasonable. Figure 517.3A-11 has an SRS calculated with the corrected acceleration time history, and the results are consistent with near-field pyroshock. The SRS in Figure 517.3A-11 can now be used to create a specification with

MIL-STD-810H
METHOD 517.3 ANNEX A

a high degree of confidence because the low-frequency asymptote is correct and the high-frequency content has been preserved. The positive and negative SRS in Figure 517.3A-11 show good agreement typical of a pyroshock or a pyroshock simulation. More details concerning the data analysis are in paragraph 6.1, reference q.

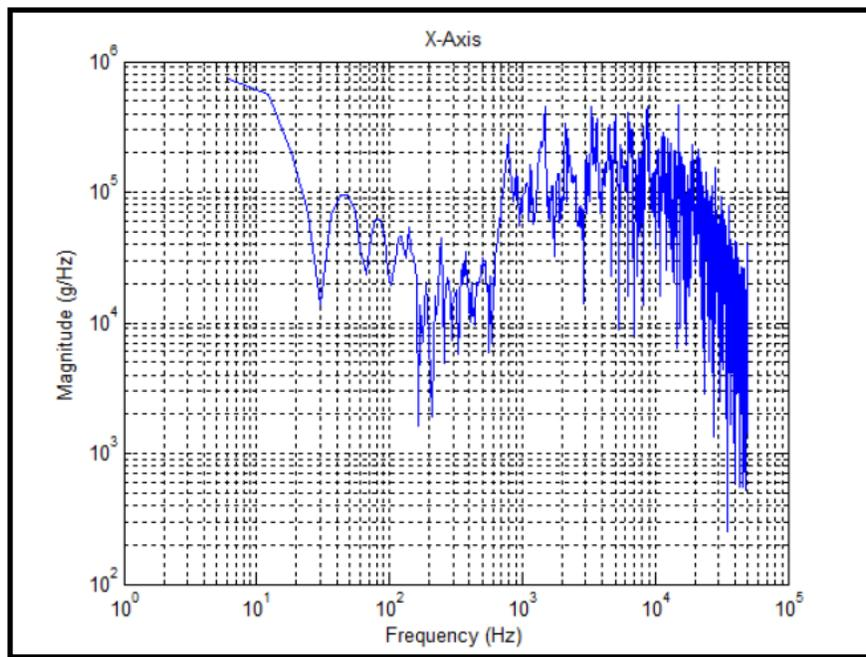


Figure 517.3A-7. Discrete Fourier transform of the data in Figure 517.3A-5.

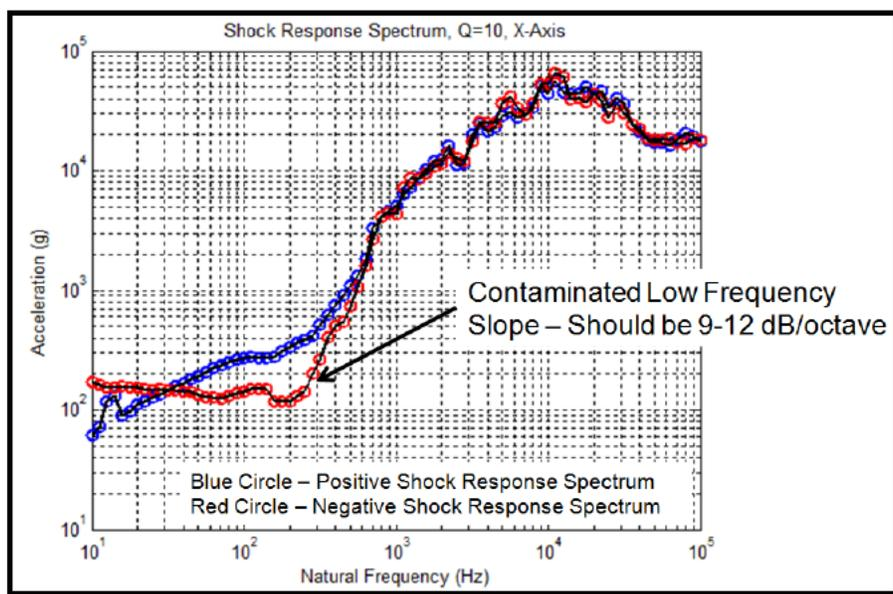


Figure 517.3A-8. Shock response spectrum of the acceleration time history in Figure 517.3A-5 ($Q=10$).

MIL-STD-810H
METHOD 517.3 ANNEX A

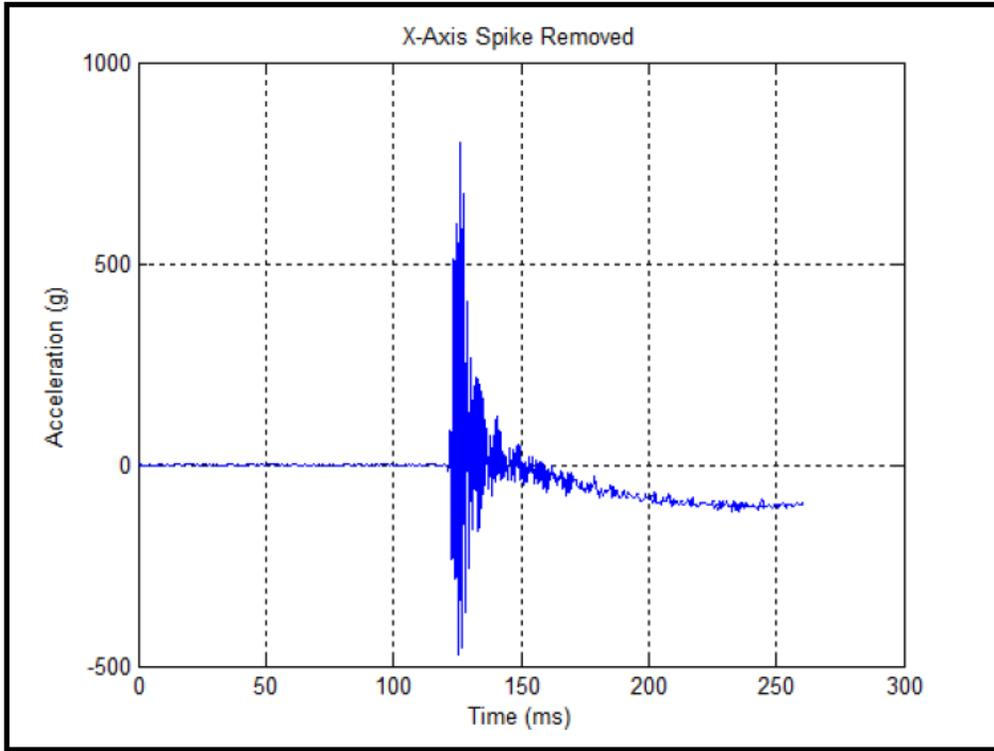


Figure 517.3A-9. Time history of wavelet correction removed from the acceleration time history in Figure 517.3A-5.

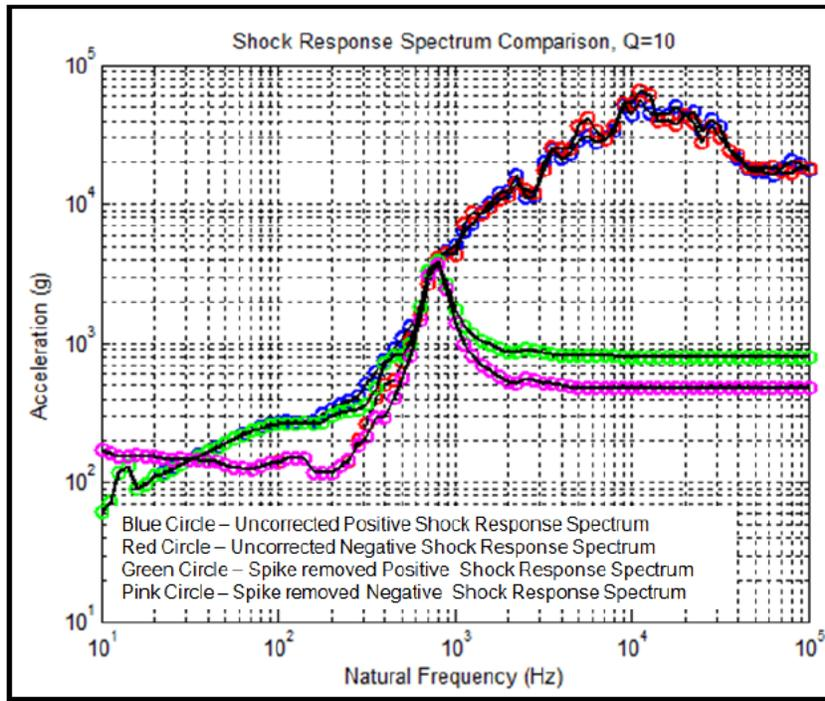


Figure 517.3A-10. Shock response spectrum comparison for corrupted acceleration (Figure 517.3A-5) and removed wavelet correct (Figure 517.3A-9) (Q=10).

MIL-STD-810H
METHOD 517.3 ANNEX A

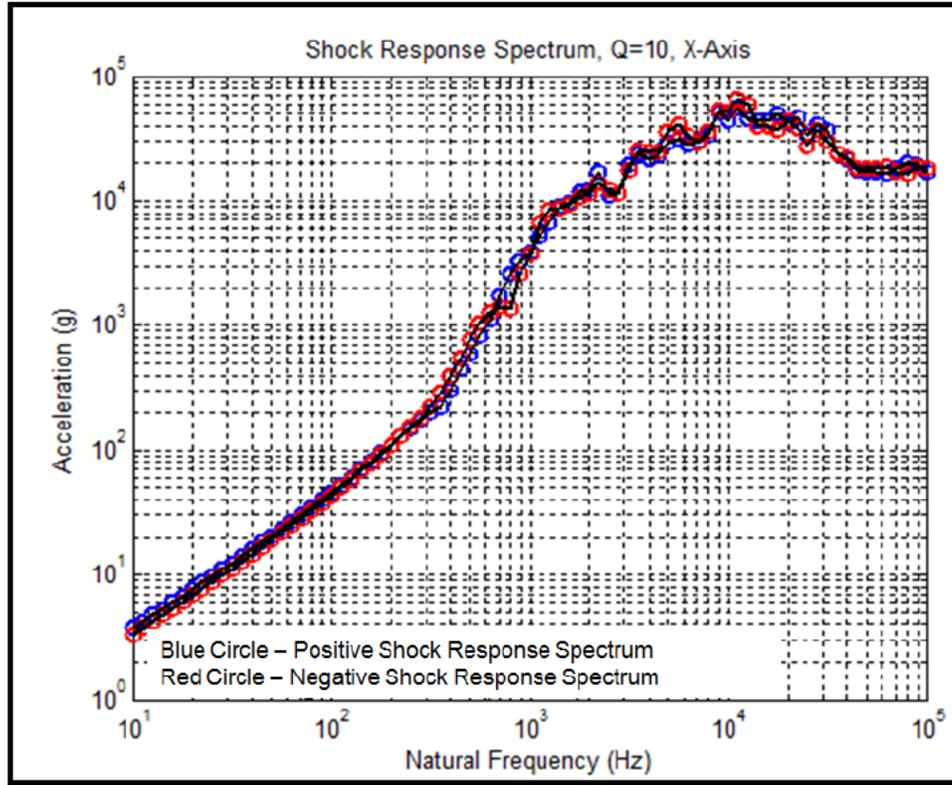


Figure 517.3A-11. Shock response spectrum calculated for the wavelet corrected acceleration time history. (Q=10).

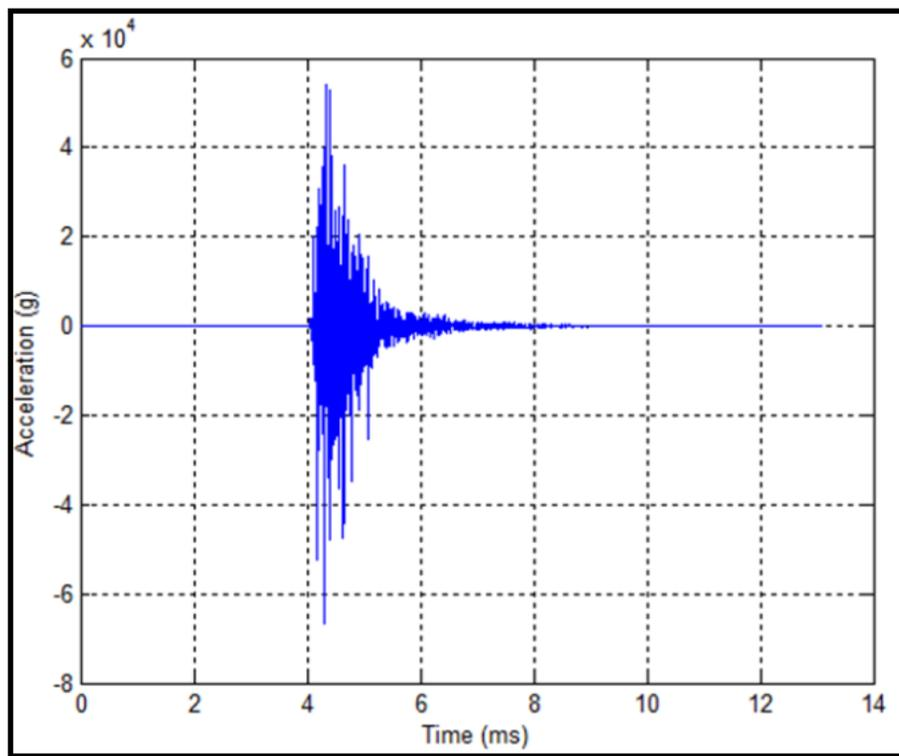


Figure 517.3A-12. A near-field pyroshock acceleration time history.

MIL-STD-810H
METHOD 517.3 ANNEX A**4. ACCELEROMETER DATA WITH BASE STRAIN EFFECTS.**

Although piezoresistive (PR) accelerometers are recommended for pyroshock measurement, these accelerometers will quite often respond to the initial compressive wave from the pyroshock with a base strain response. The base strain will create an additional velocity change in the acceleration time history. Although the strain pulse is generally not detectable in the acceleration time history, the velocity change will be evident in the integral of the acceleration.

The base strain induced into the case of a PR accelerometer during installation may be relieved with hammer taps during the initial steps in the Procedure.

Example acceleration time histories are in Figure 517.3A-12 and Figure 517.3A-14; the corresponding velocity time histories obtained by integrating the acceleration are shown in Figure 517.3A-13 and Figure 517.3A-15.

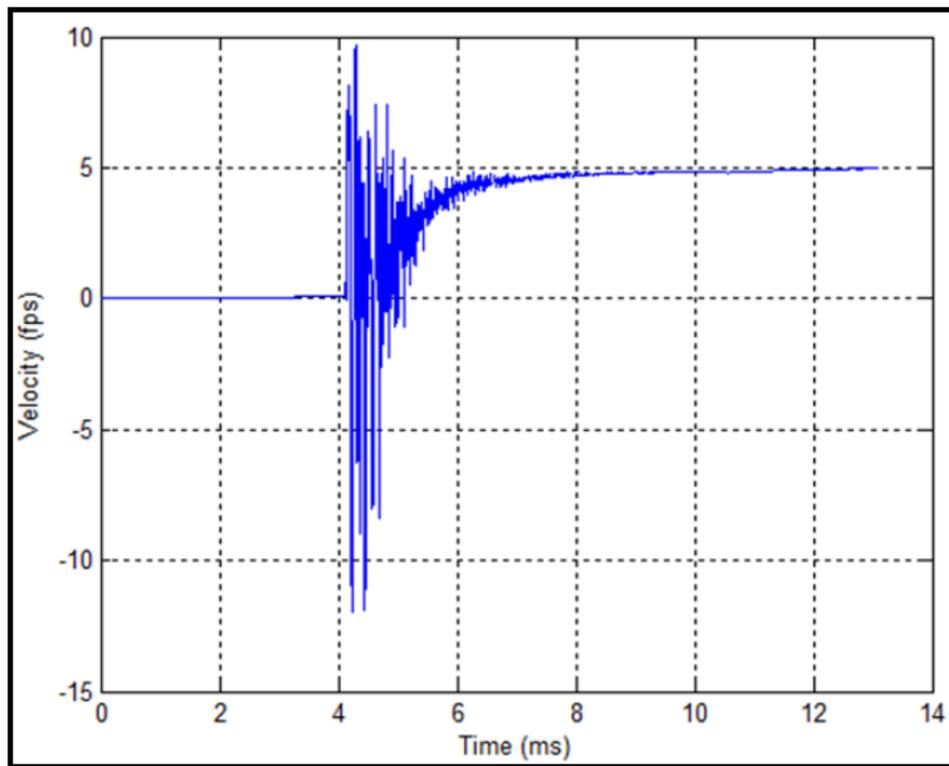


Figure 517.3A-13. The integral of the acceleration data in Figure 517.3A-12.

MIL-STD-810H
METHOD 517.3 ANNEX A

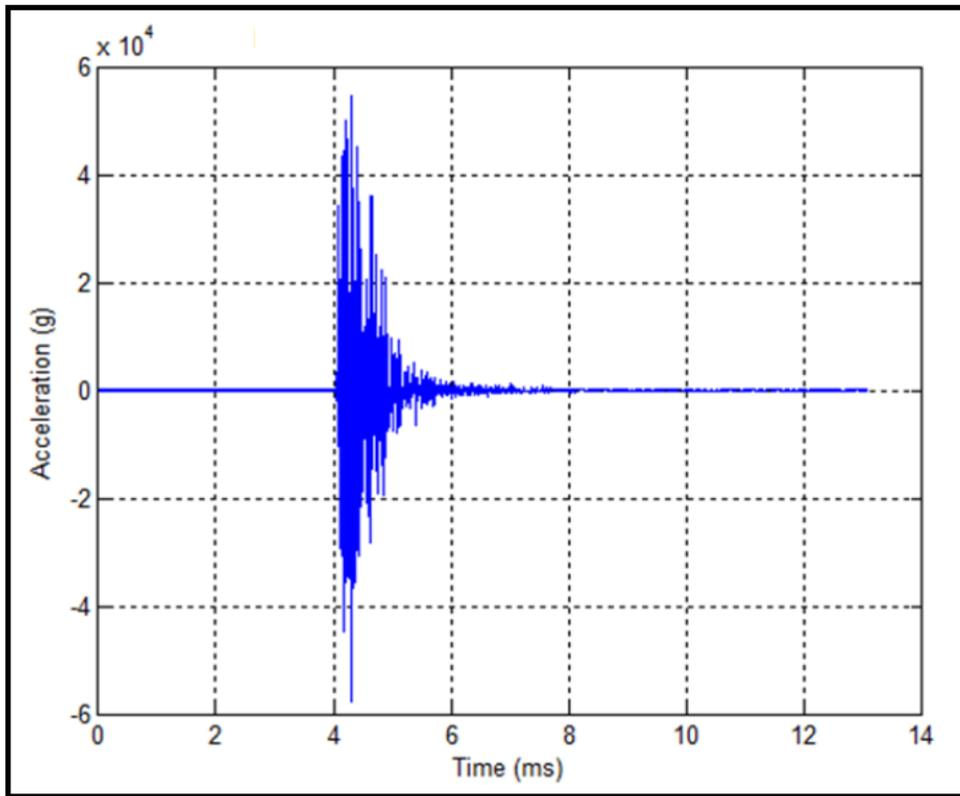


Figure 517.3A-14. A near-field pyroshock acceleration time history.

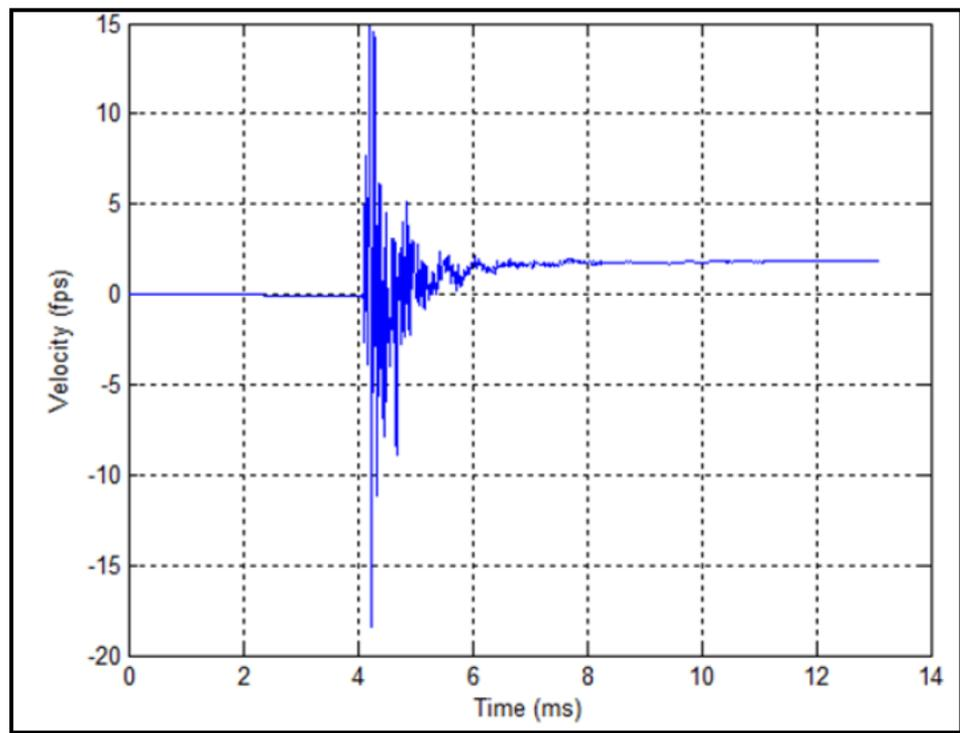


Figure 517.3A-15. The integral of the acceleration data in Figure 517.3A-14.

MIL-STD-810H
METHOD 518.2**METHOD 518.2**
ACIDIC ATMOSPHERE**CONTENTS**

<u>Paragraph</u>	<u>Page</u>
1. SCOPE	1
1.1 PURPOSE	1
1.2 APPLICATION	1
1.3 LIMITATIONS.....	1
2. TAILORING GUIDANCE	1
2.1 EFFECTS OF THE ENVIRONMENT.....	1
2.2 TEST PROCEDURE	1
2.3 SEQUENCE.....	1
2.4 DETERMINE TEST LEVELS AND CONDITIONS	2
2.4.1 TEMPERATURE SEVERITIES	2
2.4.2 TEST DURATION.....	2
2.4.3 TEST ITEM CONFIGURATION	2
2.4.4 CHEMICAL COMPOSITION AND CONCENTRATION.....	2
2.4.5 OPERATIONAL CONSIDERATIONS	3
3. INFORMATION REQUIRED.....	3
3.1 PRETEST.....	3
3.2 DURING TEST	3
3.3 POST-TEST	3
4. TEST PROCESS	4
4.1 TEST FACILITY	4
4.2 CONTROLS	4
4.3 TEST INTERRUPTIONS.....	5
4.3.1 INTERRUPTION DUE TO CHAMBER MALFUNCTION	5
4.3.2 INTERRUPTION DUE TO TEST ITEM OPERATION FAILURE	5
4.4 TEST SETUP.....	5
4.5 TEST EXECUTION	5
4.5.1 PREPARATION FOR TEST.....	5
4.5.1.1 PRELIMINARY STEPS	5
4.5.1.2 PRETEST STANDARD AMBIENT CHECKOUT.....	6
4.5.1.3 PROCEDURE	7
5. ANALYSIS OF RESULTS	7
6. REFERENCE/RELATED DOCUMENTS	7
6.1 REFERENCED DOCUMENTS.....	7
6.2 RELATED DOCUMENTS.....	7

TABLE

TABLE 518.2-I. TEMPERATURE AND PRESSURE REQUIREMENTS FOR OPERATION AT 35 °C (95 °F)	4
---	---

MIL-STD-810H
METHOD 518.2

(This page is intentionally blank.)

MIL-STD-810H
METHOD 518.2**METHOD 518.2**
ACIDIC ATMOSPHERE

NOTE: Tailoring is essential. Select methods, procedures and parameter levels based on the tailoring process described in Part One, paragraph 4.2.2, and Annex C. Apply the general guidelines for laboratory test methods described in Part One, paragraph 5 of this Standard.

1. SCOPE.**1.1 Purpose.**

Use the acidic atmosphere test to determine the resistance of materials and protective coatings to corrosive atmospheres, and when necessary, to determine its affect on operational capabilities.

1.2 Application.

Use this test Method when the requirements documents state that the materiel is likely to be stored or operated in areas where acidic atmospheres exist, such as industrial areas or near the exhausts of any fuel-burning device.

1.3 Limitations.

This Method is not a replacement for the salt fog method, nor is it suitable for evaluating the effects of hydrogen sulfide that readily oxidizes in the test environment to form sulfur dioxide. Consult ASTM G85, (paragraph 6.1, reference a) for information on introducing a sulfur dioxide environment. Caution: Although salt fog chambers are usually used for this test, introducing an acidic or sulfur dioxide atmosphere in a salt fog chamber may contaminate the chamber for future salt fog tests.

2. TAILORING GUIDANCE.**2.1 Effects of the Environment.**

Acidic atmospheres are of increasing concern, especially for materiel in the vicinity of industrial areas or near the exhausts of fuel burning devices. Examples of problems that could occur as a result of acidic atmosphere exposure are as follows. The list is not intended to be all-inclusive, and some of the examples may overlap the categories. Paragraph 6.1, reference a provides further information.

- a. Chemical attack of surface finishes and non-metallic materials.
- b. Corrosion of metals.
- c. Pitting of cement and optics.

2.2 Test Procedure.

When an acidic atmosphere test is deemed necessary, the procedure included in this method is considered suitable for most applications. The tailoring options are limited.

2.3 Sequence.

- a. General. Use the anticipated life cycle sequence of events as a general sequence guide (see Part One, paragraph 5.5).
- b. Unique to this Method. There are at least two philosophies related to test sequence. One approach is to conserve test item life by applying what are perceived to be the least damaging environments first. For this approach, generally apply the acidic atmosphere test late in the test sequence. Another approach is to apply environments to maximize the likelihood of disclosing synergetic effects. For this approach, consider acidic atmosphere testing following dynamic tests, such as vibration and shock. Perform acidic atmosphere testing after any humidity or fungus testing, and before any sand and dust testing or other tests that damage protective coatings. Because this test is similar in severity to the salt fog test, recommend separate test items be used for each.

MIL-STD-810H
METHOD 518.2

- (1) Sand and dust testing deposits may inhibit acid effects as well as abrade protective coatings.
- (2) Acid deposits may inhibit mold/fungal growth.
- (3) Residual deposits may accelerate chemical reactions during humidity testing.

2.4 Determine Test Levels and Conditions.

Having selected this method and relevant procedures (based on the test item's requirements documents and the tailoring process), complete the tailoring process by identifying appropriate parameter levels and applicable test conditions and techniques for these procedures. Base these selections on the requirements documents, the Life Cycle Environmental Profile (LCEP), and information provided with this procedure. Consider the essential parameters for defining the acidic atmosphere test that include exposure temperature, exposure time (duration), test item configuration, chemical composition of the test atmosphere, and concentration of the test solution.

2.4.1 Temperature Severities.

The test method and the exposure temperature used in this procedure are similar to that used in the salt fog test.

2.4.2 Test Duration.

Two severity levels are defined (paragraph 6.1, reference b). In view of the complexity of naturally occurring corrosion processes, no strict equivalencies with real exposure can be quoted. Use severity "a" below for simulating infrequent periods of exposure, or for exposure in areas of much lower acidity. Use severity "b" below to represent approximately 10 years natural exposure in a moist, highly industrial area, or a shorter period in close proximity to vehicle exhaust systems, particularly ship funnel exhausts where the potential acidity is significantly higher.

- a. Three 2-hour spraying periods with 22 hours storage after each.
- b. Four 2-hour spraying periods with 7 days storage after each.

2.4.3 Test Item Configuration.

The configuration of the materiel is an important factor in how an acidic atmosphere affects it. Therefore, during the test use the anticipated configuration of the materiel during storage or use. As a minimum, consider the following configurations:

- a. In a shipping/storage container or transit case.
- b. Protected or unprotected.
- c. Deployed (realistically or with restraints, such as with openings that are normally covered).
- d. Modified with kits for special applications.

2.4.4 Chemical Composition and Concentration.

Unless otherwise specified, for atomization, use a test solution containing 11.9mg (6 µl) sulfuric acid (95-98 percent)/4 liters (4.23 qt) of solution, and 8.8mg (6 µl) nitric acid (68-71 percent)/4 liters (4.23 qt) solution in distilled or deionized water. This will produce a solution with a pH of 4.17 that is representative of some of the worst rain pHs recorded for rainfall in the eastern United States and other heavily industrialized areas with acidic emissions. Paragraph 6.1, reference c, provides information regarding the more common chemical environmental contaminants together with some consequent likely forms of corrosion that material could encounter.

WARNING: Strong acids are hazardous. The solution to be sprayed is harmful to people and clothing. Operators carrying out the test must take suitable precautions.

WARNING: Refer to the supplier's Safety Data Sheet (SDS) or equivalent for health hazard data.

MIL-STD-810H
METHOD 518.2

- a. Do not enter the chamber during atomization and, before entry after exposure, purge the chamber with clean air to a level that will satisfy local safety requirements. Continue purging at intervals if necessary to ensure the concentration of noxious fumes remains at a suitably low level.
- b. Wear a suitable respirator and/or eye protection. Use rubber gloves to handle materiel.
- c. See paragraph 4.1b for hazardous waste disposal information.

2.4.5 Operational Considerations.

The test item will not normally be required to function during the test, but may be required to do so upon completion of the test, or on completion of a representative sequence of environmental tests.

3. INFORMATION REQUIRED.

3.1 Pretest.

The following information is required to conduct acidic atmosphere tests adequately:

- a. General. Information listed in Part One, paragraphs 5.7 and 5.9; and Annex A, Task 405 of this Standard.
- b. Specific to this Method.
 - (1) Areas of the test item visually and functionally examined, and an explanation of their inclusion or exclusion.
 - (2) Whether the test is a demonstration of performance or survival.
 - (3) Whether the requirement is to demonstrate safety, safety and performance, or resistance to chemical attack after the test.
 - (4) If functional performance is to be assessed, the phases of the test when the test item is to function and be assessed, and the levels of performance required.
- c. Tailoring. Necessary variations in the basic test procedures to accommodate environments identified in the LCEP.

3.2 During Test.

Collect the following information during conduct of the test:

- a. General. Information listed in Part One, paragraph 5.10; and in Annex A, Tasks 405 and 406 of this Standard.
- b. Specific to this Method.
 - (1) Record of chamber temperature versus time conditions.
 - (2) Fallout quantities per unit of time (see paragraph 4.1g).
 - (3) Fallout pH.

3.3 Post-Test.

The following post test data shall be included in the test report.

- a. General. Information listed in Part One, paragraph 5.13; and in Annex A, Task 406 of this Standard.
- b. Specific to this Method.
 - (1) Areas of the test item visually and functionally examined and an explanation of their inclusion or exclusion.
 - (2) Test variables:
 - (a) Test solution pH.
 - (b) Test solution fallout rate (ml/cm²/hr).
 - (3) Results of examination for corrosion, electrical, and physical effects.
 - (4) Observations to aid in failure analysis.

MIL-STD-810H
METHOD 518.2

- (5) Any deviation from the original test plan.

4. TEST PROCESS.**4.1 Test Facility.**

- a. For construction of the chamber, supporting racks, and atomization equipment use materials inert to the acid solution being sprayed, and that will not cause electrolytic corrosion with material with which it comes in contact.
- b. Ensure the test chamber has a waste collection system so that all waste material can be tested prior to disposal. Dispose of any material determined to be hazardous waste in accordance with local, state, and federal regulations.
- c. Do not reuse acidic test solution drippings from the walls and ceilings of the chamber and from the test item. Vent the exposure chamber to prevent pressure buildup.
- d. Use a chamber capable of maintaining temperatures in the exposure zone at 35 ± 2 °C (95 ± 4 °F). Continuously control this temperature during the test. Do not use immersion heaters within the chamber exposure area for the purpose of maintaining the temperature within the exposure zone.
- e. Use an acid solution reservoir and dispenser made of material that is non-reactive with the acid solution, e.g., glass, hard rubber, or plastic. The reservoir provides a continuous supply to a tank normally (but not necessarily) situated inside the test section in which the acid solution level is held reasonably constant. The atomizers are connected to this tank.
- f. Use a chamber with a means for injecting the acid solution into the test chamber and with an input air humidifier to minimize clogging of the nozzles. Use atomizers of such design and construction as to produce a finely divided, wet, dense fog. Use atomizing nozzles and a piping system made of material that is non-reactive to the acid solution. Use a facility designed to provide the required atomization distribution and fallout.
- g. Use a test setup that includes a minimum of 2 fallout collection receptacles. One is to be at the perimeter of the test item nearest to the nozzle, and the other also at the perimeter of the test item but at the farthest point from the nozzle. If multiple nozzles are used, the same principles apply. Place the receptacles so that they are not shielded by the test item and will not collect drops of solution from the test item or other sources.
- h. Constant air pressure for the continuous, uniform atomization of the acid solution using a compressed air supply, and produce a fallout such that each receptacle collects from 1 to 3 ml (0.03 to 0.10 oz) of solution per hour for each 80 cm² (12.4 in.²) of horizontal collecting area (10 cm (3.9 in.) diameter).

4.2 Controls.

- a. Compressed air. Preheat the oil and dirt-free compressed air used to produce the atomized solution (to offset the cooling effects of expansion to atmospheric pressure), and pre-humidify it such that the temperature is 35 ± 2 °C (95 ± 4 °F), and the relative humidity is in excess of 85 percent at the nozzle (see Table 518.2-I)
- b. Preheating. Heat the acid solution to within ± 6 °C (± 11 °F) of the test section temperature before injection into the test section.
- c. Test section air circulation. Use an air velocity in the test chambers that is minimal (essentially zero).

Table 518.2-I. Temperature and pressure requirements for operation at 35 °C (95 °F).

Air Pressure (kPa(psi))	83 (12)	96 (14)	110 (16)	124 (18)
Preheat temperature (°C (°F)) (BEFORE ATOMIZING)	46 (115)	47(117)	48(118)	49(120)

MIL-STD-810H
METHOD 518.2**4.3 Test Interruptions.**

Test interruptions can result from two or more situations, one being from failure or malfunction of test chambers or associated test laboratory equipment. The second type of test interruption results from failure or malfunction of the test item itself during operational checks.

4.3.1 Interruption Due To Chamber Malfunction.

- a. General. See Part One, paragraph 5.11 of this Standard.
- b. Specific to this Method.
 - (1) Undertest Interruption. If an unscheduled test interruption occurs that causes the test conditions to exceed allowable tolerances toward standard ambient conditions, give the test item a complete visual examination and develop a technical evaluation of the impact of the interruption on the test results. Restart the test at the point of interruption and restabilize the test item at the test conditions.
 - (2) Overtest Interruption. If an unscheduled test interruption occurs that causes the test conditions to exceed allowable tolerances away from standard ambient conditions, stabilize the test conditions to within tolerances and hold them at that level until a complete visual examination and technical evaluation can be made to determine the impact of the interruption on test results. If the visual examination or technical evaluation results in a conclusion that the test interruption did not adversely affect the final test results, or if the effects of the interruption can be nullified with confidence, restabilize the pre-interruption conditions and continue the test from the point where the test tolerances were exceeded.

4.3.2 Interruption Due To Test Item Operation Failure.

Failure of the test item(s) to function as required during operational checks presents a situation with several possible options.

- a. The preferable option is to replace the test item with a “new” one and restart from Step 1.
- b. A second option is to replace / repair the failed or non-functioning component or assembly with one that functions as intended, and restart the entire test from Step 1.

NOTE: When evaluating failure interruptions, consider prior testing on the same test item and consequences of such.

4.4 Test Setup.

- a. General. See Part One, paragraph 5.8.
- b. Unique to this Method. Ensure the fallout collection containers are situated in the chamber such that they will not collect fluids dripping from the test item.

4.5 Test Execution.

The following steps, alone or in combination, provide the basis for collecting necessary information concerning the test item in an acidic atmosphere environment.

4.5.1 Preparation for Test.**4.5.1.1 Preliminary Steps.**

- a. Prepare a test solution as specified in paragraph 2.4.4.

MIL-STD-810H
METHOD 518.2

NOTE: MAKE THE SOLUTION BY ADDING ACID TO WATER, NOT VICE VERSA.

WARNING: Refer to the supplier's Material Safety Data Sheet (MSDS) or equivalent for health hazard data.

Strong acids are hazardous, and the solution to be used is harmful to people and clothing. Operators carrying out the test must take suitable precautions, and use personal protective equipment (PPE).

- (1) Do not enter the chamber during atomization. Before entry after atomization, purge the chamber with clean air to a level that will satisfy local safety requirements. Continue purging at intervals if necessary to ensure the concentration of noxious fumes remains at a suitably low level.
 - (2) Wear a suitable respirator and/or eye protection. Use rubber gloves to handle material.
- b. Chamber operation verification: Immediately before the test and with the exposure chamber empty, adjust all test parameters to those levels required for the test. Maintain these conditions for at least one 24-hour period (or until proper operation and fallout collection can be verified). With the exception of fallout rate, continuously monitor all test parameters to verify that the test chamber is operating properly.
- c. Conduct an operational checkout in accordance with the test plan and record the results for compliance with Part One, paragraph 5.9. Handle the test item as little as possible, particularly on the significant surfaces, and prepare it for test immediately before exposure. Unless otherwise specified, use test items free of surface contamination such as oil, grease, or dirt that could cause dewetting. Do not include the use of corrosive solvents, solvents that deposit either corrosive or protective films, or abrasives other than pure magnesium oxide in the cleaning methods.

4.5.1.2 Pretest Standard Ambient Checkout.

All items require a pretest checkout at room ambient conditions to provide baseline data. Conduct the checkout as follows:

- Step 1 Prepare the test item in its required configuration in accordance with Part One, paragraph 5.8.1.
- Step 2 Conduct a complete visual examination of the test item with attention to:
- (a) High-stress areas.
 - (b) Areas where dissimilar metals are in contact.
 - (c) Electrical and electronic components - especially those having closely spaced, unpainted or exposed circuitry.
 - (d) Metallic surfaces.
 - (e) Enclosed volumes where condensation has occurred or may occur.
 - (f) Components or surfaces provided with coatings or surface treatments for corrosion protection.
 - (g) Cathodic protection systems; mechanical systems subject to malfunction if clogged or coated with salt deposits.
 - (h) Electrical and thermal insulators.

NOTE: Consider partial or complete disassembly of the test item if a complete visual examination is required. Be careful not to damage any protective coatings, etc.

MIL-STD-810H
METHOD 518.2

- Step 3 Document the results. (Use photographs, if necessary.)
- Step 4 Conduct an operational checkout in accordance with the test plan and record the results for compliance with Part One, paragraph 5.9.
- Step 5 If the test item meets the requirements of the test plan or other applicable documents, proceed to Step 1 of the test procedure below. If not, resolve any problems and restart the pretest standard ambient checkout at the most reasonable step above.

4.5.1.3 Procedure.

- Step 1 With the test item installed in the test chamber in its storage configuration (or as otherwise specified in the requirements documents), adjust the test chamber temperature to 35 °C (95 °F), and temperature condition the test item for at least 2 hours before introducing the acid solution.
- Step 2 Expose the test item to one of the two following severities as specified in the test plan. (See paragraph 2.4.2.) During either the (a) or (b) options shown below, continuously atomize the acidic solution (of a composition as given in paragraph 2.4.4). During the entire exposure period, measure the acidic solution fallout rate and pH at least at 24-hour intervals (Recommend more frequent intervals. Repeat the interval if fallout quantity requirements are not met). Ensure the fallout is between 1 and 3 ml/80cm²/hr.
 - (a) Four 2-hour exposure periods with 7 days storage after each.
 - (b) Three 2-hour exposure periods with 22 hours storage after each.
- Step 3 At the completion of Step 2, stabilize the test item at standard ambient conditions.
- Step 4 Using appropriate protective clothing, visually examine the test item to the extent practical.
- Step 5 If required, place the test item in an operational configuration and conduct an operational check of the test item. See paragraph 5 for analysis of results.
- Step 6 If required, test items may be cleaned by rinsing with a dilute sodium bicarbonate solution (to neutralize any acidic residue), followed by distilled/deionized water, and dried by the application of heat (up to 55 °C (131 °F)), where this is acceptable, or by other means. Collect the rinse water and check it for hazardous substances prior to disposal (see paragraph 4.1b also).
- Step 7 At the end of this test, and in conformity with the requirements documents, examine the test item for corrosion and deterioration of parts, finishes, materials, and components. Document the results.

5. ANALYSIS OF RESULTS.

In addition to the guidance provided in Part One, paragraphs 5.14 and 5.17, the following information is provided to assist in the evaluation of the test results. Analyze any corrosion for its immediate effect on the satisfactory operation of the test item. Satisfactory operation following this test is not the sole criterion for pass/fail.

6. REFERENCE/RELATED DOCUMENTS.**6.1 Referenced Documents.**

- a. ASTM G85, "Standard Practice for Modified Salt Spray (Fog) Testing", ASTM International. Visit the ASTM Website or contact ASTM Customer Service at service@astm.org.
- b. International Electrotechnical Commission (IEC) 68-2-52, 1966, Test Kb, Salt Mist, Cyclic, NaCl solution.
- c. Acid Deposition in the United Kingdom, Warren Spring Laboratory, ISBN 085624 323X (UK).

6.2 Related Documents.

- a. DEF STAN 00-50, Guide to Chemical Environmental Contaminants and Corrosion Affecting the Design of Military Materiel (UK).
- b. NATO STANAG 4370, Environmental Testing.
- c. NATO Allied Environmental Conditions and Test Publication (AECTP) 300, Climatic Environmental Tests, Method 319, "Acidic Atmosphere".

MIL-STD-810H
METHOD 518.2

- d. Egbert, Herbert W. "The History and Rationale of MIL-STD-810 (Edition 2)", January 2010; Institute of Environmental Sciences and Technology, Arlington Place One, 2340 S. Arlington Heights Road, Suite 100, Arlington Heights, IL 60005-4516.

(Copies of Department of Defense Specifications, Standards, and Handbooks, and International Standardization Agreements are available online at <https://assist.dla.mil>.)

Requests for other defense-related technical publications may be directed to the Defense Technical Information Center (DTIC), ATTN: DTIC-BR, Suite 0944, 8725 John J. Kingman Road, Fort Belvoir VA 22060-6218, 1-800-225-3842 (Assistance--selection 3, option 2), <http://www.dtic.mil/dtic/>; and the National Technical Information Service (NTIS), Springfield VA 22161, 1-800-553-NTIS (6847), <http://www.ntis.gov/>.

MIL-STD-810H
METHOD 519.8**METHOD 519.8**
GUNFIRE SHOCK**CONTENTS**

<u>Paragraph</u>	<u>Page</u>
1. SCOPE	1
1.1 PURPOSE	1
1.2 APPLICATION	1
1.3 LIMITATIONS.....	2
2. TAILORING GUIDANCE	2
2.1 SELECTING THE GUNFIRE SHOCK METHOD.....	2
2.1.1 EFFECTS OF A GUNFIRE SHOCK ENVIRONMENT	2
2.1.2 SEQUENCE AMONG OTHER METHODS.....	3
2.2 SELECTING A PROCEDURE.....	4
2.2.1 PROCEDURE SELECTION CONSIDERATIONS	4
2.2.2 DIFFERENCE AMONG PROCEDURES.....	5
2.3 DETERMINE TEST LEVELS AND CONDITIONS	6
2.3.1 GENERAL CONSIDERATIONS	6
2.3.2 TEST CONDITIONS	6
2.3.3 TEST AXES AND NUMBER OF GUNFIRE SHOCK EVENTS	6
2.4 TEST ITEM CONFIGURATION (SEE PART ONE, PARAGRAPH 5.8)	7
2.5 CONTROLS	7
2.5.1 CONTROL OPTIONS	7
2.5.1.1 OPEN/CLOSED LOOP	7
2.5.1.2 SINGLE POINT CONTROL	7
2.5.1.3 MULTIPLE POINT CONTROL	7
2.5.2 CONTROL METHODS	7
2.5.2.1 WAVEFORM CONTROL	7
2.5.2.2 SPECTRUM CONTROL	7
3. INFORMATION REQUIRED.....	8
3.1 PRETEST.....	8
3.2 DURING TEST.....	9
3.3 POST-TEST	9
4. TEST PROCESS	10
4.1 TEST FACILITY	10
4.2 CONTROLS	10
4.2.1 MEASURED MATERIEL INPUT/RESPONSE TIME HISTORY UNDER TWR.....	12
4.2.2 SRS GENERATED SHOCK TIME HISTORY PULSE SEQUENCE UNDER TWR.....	12
4.2.3 STOCHASTICALLY GENERATED MATERIEL INPUT FROM PRELIMINARY DESIGN SPECTRUM UNDER TWR.....	12
4.3 TEST INTERRUPTION	12
4.3.1 INTERRUPTION FROM FAILURE OR MALFUNCTION OF ASSOCIATED LABORATORY TEST EQUIPMENT	13
4.3.2 INTERRUPTION DUE TO TEST ITEM OPERATION FAILURE	13
4.4 TEST EXECUTION	13
4.4.1 PREPARATION FOR TEST.....	13

MIL-STD-810H
METHOD 519.8

CONTENTS - Continued

<u>Paragraph</u>	<u>Page</u>
4.4.1.1 PRETEST CHECKOUT	13
4.4.1.2 PROCEDURE OVERVIEW	13
4.4.1.3 TEST ITEM CONSIDERATIONS	14
4.4.2 PROCEDURE I - MEASURED MATERIEL INPUT/RESPONSE TIME HISTORY UNDER TWR	14
4.4.2.1 CONTROLS	14
4.4.2.2 TEST TOLERANCES.....	14
4.4.2.3 PROCEDURE STEPS.....	14
4.4.2.4 ANALYSIS OF RESULTS	14
4.4.3 PROCEDURE II - SRS GENERATED SHOCK TIME HISTORY PULSE SEQUENCE UNDER TWR	15
4.4.3.1 CONTROLS	15
4.4.3.2 TEST TOLERANCES.....	15
4.4.3.3 PROCEDURE STEPS.....	15
4.4.3.4 ANALYSIS OF RESULTS	15
4.4.4 PROCEDURE III - STOCHASTICALLY GENERATED MATERIEL INPUT FROM PRELIMINARY DESIGN SPECTRUM	15
4.4.4.1 CONTROLS	15
5. ANALYSIS OF RESULTS	16
6. REFERENCE/RELATED DOCUMENTS	16
6.1 REFERENCED DOCUMENTS.....	16
6.2 RELATED DOCUMENTS.....	17

METHOD 519.8, ANNEX A

GUIDELINES FOR PROCEDURE I - MEASURED MATERIEL INPUT/RESPONSE TIME HISTORY UNDER TWR

1. SCOPE	A-1
1.1 PURPOSE	A-1
1.2 APPLICATION	A-1
2. DEVELOPMENT.....	A-1
2.1 BASIC CONSIDERATIONS FOR ENVIRONMENTAL DETERMINATION.....	A-1
2.2 TEST CONFIGURATION	A-1
2.3 CREATING A DIGITAL FILE OF THE MEASURED GUNFIRE SHOCK INPUT TO THE MATERIEL	A-2
2.4 REPLICATING THE MEASURED GUNFIRE SHOCK MATERIEL INPUT IN LABORATORY TEST	A-3
2.5 POST-TEST PROCESSING	A-4
2.6 CONCLUSION.....	A-11
2.6.1 GENERAL REMARKS.....	A-11
2.6.2 STOCHASTIC GENERATION.....	A-11

MIL-STD-810H
METHOD 519.8

CONTENTS - Continued

ANNEX A FIGURES

FIGURE 519.8A-1.	IN-SERVICE MEASURED GUNFIRE SHOCK: UNPROCESSED TIME TRACE (2000 RND/MIN AND 4000 RND/MIN)	A-2
FIGURE 519.8A-2.	UNPROCESSED TWR TEST REFERENCE, CONTROL, AND DIFFERENCE TIME TRACES (10 HZ TO 2000 HZ 25600 SPS)	A-3
FIGURE 519.8A-3.	BANDLIMITED (10 HZ TO 2000 HZ) AND UNPROCESSED TWR TEST CONTROL TIME TRACES....	A-4
FIGURE 519.8A-4.	HIGH RESOLUTION REPRESENTATIVE MEMBERS FOR THE PULSE ENSEMBLES (2000 ROUNDS/MINUTE)	A-5
FIGURE 519.8A-5.	HIGH RESOLUTION REPRESENTATIVE MEMBERS FOR THE PULSE ENSEMBLES (4000 ROUNDS/MINUTE)	A-6
FIGURE 519.8A-6.	STARMS DIFFERENCE BETWEEN CONTROL AND REFERENCE WITH CROSS-CORRELATION ESTIMATE (DIFFERENCE: REF = 45.1 G-RMS / CROSS-CORRELATION)	A-7
FIGURE 519.8A-7.	STARMS FOR DIFFERENCE TIME TRACE(DIFFERENCE: REF = 45.1 G-RMS)	A-8
FIGURE 519.8A-8.	QQ-PLOT FOR GAUSSIAN VERSUS DIFFERENCE TIME TRACE	A-8
FIGURE 519.8A-9.	REFERENCE VERSUS CONTROL CROSS-PLOT	A-9
FIGURE 519.8A-10A.	PEAK STATISTIC DIFFERENCE.....	A-10
FIGURE 519.8A-10B.	PEAK/VALLEY STATISTIC DIFFERENCE-QQ-PLOT.....	A-10

ANNEX A TABLE

TABLE 519.8A-I.	PEAK STATISTIC DIFFERENCE STATISTICS	A-11
-----------------	--	------

METHOD 519.8, ANNEX B

GUIDELINES FOR PROCEDURE II - SRS GENERATED SHOCK TIME HISTORY PULSE SEQUENCE UNDER TWR

1.	SCOPE	B-1
1.1	PURPOSE	B-1
1.2	APPLICATION	B-1
2.	BASIC CONSIDERATIONS FOR DETERMINISTIC GENERATION OF A TIME TRACE HISTORY FROM A SRS ESTIMATE	B-2
2.1	INTRODUCTION	B-2
2.2	SINGLE GUNFIRE SHOCK EVENT WITH SRS SPECIFICATION.....	B-2
2.3	MULTIPLE GUNFIRE SHOCK EVENTS WITH SRS CONSIDERATIONS	B-6
3.	CONCLUSION.....	B-6

ANNEX B FIGURES

FIGURE 519.8B-1.	GENERIC EXAMPLE GUNFIRE SRS REFERENCE.....	B-2
FIGURE 519.8B-2.	DETERMINISTIC SRS SINE-BEAT SYNTHESIZED PULSE (EXTENDED OVER 20 MILLISECONDS FOR 50 HZ GUNFIRING RATE)	B-3
FIGURE 519.8B-3.	CONCATENATED HIGH FREQUENCY SYNTHESIS (200 – 2000 HZ)	B-4
FIGURE 519.8B-4.	BANDLIMITED RANDOM SYNTHESIS (10 HZ- 200 HZ)	B-5
FIGURE 519.8B-5.	SYNTHESIZED ONE-SECOND GUNFIRE SHOCK PULSE TRAIN REFERENCE PER ADDITIVE MODEL	B-6

MIL-STD-810H
METHOD 519.8

CONTENTS - Continued

METHOD 519.8, ANNEX C

GUIDELINES FOR PROCEDURE III - STOCHASTICALLY GENERATED MATERIEL INPUT FROM PRELIMINARY DESIGN SPECTRUM

1.	SCOPE	C-1
-----------	--------------------	------------

**PART 1 –SPECTRUM PREDICTION METHODOLOGY
FOR PRELIMINARY MATERIEL DESIGN**

1.	SCOPE	C-2
1.1	PURPOSE	C-2
1.2	APPLICATION	C-2
1.3	LIMITATIONS	C-2
2.	DEVELOPMENT.....	C-2
2.1	INTRODUCTION	C-2
2.2	PREDICTING GUNFIRE VIBRATION SPECTRA	C-3
2.3	DURATION OF TEST.....	C-10
2.4	SPECTRUM GENERATION TECHNIQUES	C-10

**PART 2 – IMPLEMENTATION OF PREDICTED SPECTRUM METHODOLOGY FOR
PRELIMINARY MATERIEL DESIGN**

1.	SCOPE	C-11
1.1	PURPOSE	C-11
1.2	TIME DOMAIN WINDOWED PULSE (TDWP).....	C-11
1.2.1	INTRODUCTION	C-11
1.2.2	OUTLINE OF IMPLEMENTATION	C-11
1.3	RANDOM MODULATED HARMONIC PULSE (RMHP)	C-12
1.3.1	INTRODUCTION	C-12
1.3.2	OUTLINE OF IMPLEMENTATION	C-12
2.	RECOMMENDED PROCEDURES.....	C-12
2.1	RECOMMENDED PROCEDURE	C-12
2.2	UNCERTAINTY FACTORS	C-12
2.2.1	SOR PREDICTION METHODOLOGY UNCERTAINTY.....	C-12
2.2.2	STOCHASTIC TWR GENERATION UNCERTAINTY	C-13

ANNEX C FIGURES

FIGURE 519.8C-1.	GENERALIZED GUNFIRE INDUCED VIBRATION SPECTRUM SHAPE	C-3
FIGURE 519.8C-2.	THE DISTANCE PARAMETER (D) AND DEPTH PARAMETER (R_s).....	C-6
FIGURE 519.8C-3.	MULTIPLE GUNS, CLOSELY GROUPED	C-6
FIGURE 519.8C-4.	TEST LEVEL REDUCTION DUE TO GUN STANDOFF PARAMETER.....	C-7
FIGURE 519.8C-5.	TEST LEVEL REDUCTION DUE TO MATERIEL MASS LOADING	C-7
FIGURE 519.8C-6.	TEST LEVEL REDUCTION DUE TO DEPTH PARAMETER.....	C-8
FIGURE 519.8C-7.	DECREASE IN VIBRATION LEVEL WITH VECTOR DISTANCE FROM GUN MUZZLE.....	C-8
FIGURE 519.8C-8.	GUNFIRE PEAK VIBRATION REDUCTION WITH DISTANCE.....	C-9

MIL-STD-810H
METHOD 519.8

CONTENTS - Continued

ANNEX C TABLES

TABLE 519.8C-I.	SUGGESTED GENERALIZED PARAMETRIC EQUATIONS FOR GUNFIRE-INDUCED VIBRATION.....	C-4
TABLE 519.8C-II.	TYPICAL GUN CONFIGURATIONS ASSOCIATED WITH AIRCRAFT CLASSES	C-5
TABLE 519.8C-III.	GUN SPECIFICATIONS.....	C-5

MIL-STD-810H
METHOD 519.8

(This page is intentionally blank.)

MIL-STD-810H
METHOD 519.8

METHOD 519.8
GUNFIRE SHOCK

NOTE: Tailoring is essential. Select Methods, procedures, and parameter levels based on the tailoring process described in Part One, paragraph 4.2.2, and Annex C. Apply the general guidelines for laboratory test methods described in Part One, paragraph 5 of this Standard.

Due to extensive revision to this method, no change bars have been provided.

1. SCOPE.

1.1 Purpose.

Gunfire shock tests are performed to provide a degree of confidence that materiel can structurally and functionally withstand the relatively infrequent, short duration transient high rate repetitive shock input encountered in operational environments during the firing of guns.

1.2 Application.

Use this Method to evaluate the structural and functional performance of materiel likely to be exposed to a gunfire shock environment in its lifetime. This test Method is applicable when materiel is required to demonstrate its adequacy to resist a "gunfire schedule" environment without unacceptable degradation of its structural integrity and functional performance ("gunfire schedule" here refers to the firing rate, the number of rounds fired in a given firing, and the number of firing events). The gunfire environment may be considered to be a high rate repetitive shock having form of a substantial transient vibration produced by (1) an airborne gun muzzle blast pressure wave impinging on the materiel at the gun firing rate, (2) a structure-borne repetitive shock transmitted through structure connecting the gun mechanism and the materiel, and/or a combination of (1) and (2). The closer the materiel surface is to direct pressure pulse exposure, the more likely the measured acceleration environment appears as a repetitive shock producing "very short" rise time and rapid decay of materiel response, and the less role the structure-borne repetitive shock contributes to the overall materiel response environment. The farther the materiel surface is from direct pressure pulse exposure, the more the measured acceleration environment appears as a structure-borne high rate repetitive shock (or a substantial transient vibration) with some periodic nature that has been filtered by the structure intervening between the gun mechanism and the materiel. Repetitive shock applied to a complex multi-modal materiel system will cause the materiel to respond (1) at forced frequencies imposed on the materiel from the external excitation environment, and (2) to the materiel's resonant natural frequencies either during or immediately after application of the external excitation. Such response may cause:

- a. Materiel failure as a result of increased or decreased friction between parts, or general interference between parts.
- b. Changes in materiel dielectric strength, loss of insulation resistance, variations in magnetic and electrostatic field strength.
- c. Materiel electronic circuit card malfunction, electronic circuit card damage, and electronic connector failure. (On occasion, circuit card contaminants having the potential to cause short circuits may be dislodged under materiel response to gunfire environment)
- d. Permanent mechanical deformation of the materiel as a result of overstress of materiel structural and non-structural members.
- e. Collapse of mechanical elements of the materiel as a result of the ultimate strength of the element being exceeded.
- f. Accelerated fatiguing of materials (low cycle fatigue).
- g. Potential piezoelectric activity of materials.
- h. Materiel failure as a result of cracks and fracture in crystals, ceramics, epoxies, or glass envelopes.

MIL-STD-810H
METHOD 519.8**1.3 Limitations.**

This Method provides limited information with regard to the prediction of input levels to materiel based only on the gun parameters and the geometrical configuration between the gun and materiel. Procedure III is provided for purposes of preliminary materiel design when no other information is available. The shock form of time trace information generated in Procedure III may be tested under Time Waveform Replication (TWR) as a recommended practice. It may not be possible to replicate some operational service gunfire materiel response environments because of impedance mismatches. In particular, laboratory fixture limitations or other physical constraints may prevent the satisfactory application of gunfire-induced excitation to a test item in the laboratory. In addition, this Method:

- a. Does not provide guidelines for separating air-borne from structure-borne excitation input to materiel. It is important that a trained structural dynamicist examine the structural configuration and any measured data to determine the transmission path(s) from the gun excitation source to the materiel.
- b. Does not provide guidance on techniques for isolation of the materiel from the source of excitation.
- c. Does not provide guidance on materiel design to avoid unacceptable structural or functional materiel degradation during gun firing, e.g., shock isolation.
- d. Does not include the repetitive shock effects experienced by large extended materiel, e.g., airframe structural systems over which varied parts of the materiel may experience spatially correlated external excitation. For this type of repetitive shock, with degrees of input and response spatial correlation from the external excitation, specialized tests based on experimentally measured data must be employed.
- e. Does not include provisions for performing gunfire tests at high or low temperatures including the extreme temperature environment directly related to the gunfire pressure wave emission and subsequent materiel absorption of this thermal energy. Perform tests at standard ambient temperature unless otherwise specified. However, thermal energy generated from the gun blast pressure wave may be an important design consideration for materiel close to the gun muzzle.
- f. Is not intended to simulate blast pressure or acoustic effects on materiel as a result of exposure to gunfire environment. This Method assumes materiel acceleration as the measurement variable but does not limit consideration to other materiel input/response variables, e.g., force.
- g. In general, it provides limited guidance on materiel response to gun excitation from simultaneous firing of more than one gun.
- h. Does not address benign gunfire shock environments where materiel input or response may be a form of transient random vibration, with peak root-mean-square levels below the levels of materiel qualification to stationary random vibration as determined by the square root of the area under the Autospectral Density Estimate (ASD).
- i. Does not provide guidance on "single shot" gunfire response from large guns e.g., Navy ship guns. For such gunfire response representing basically a single shock to materiel, guidance in Method 516 is applicable.

2. TAILORING GUIDANCE.**2.1 Selecting the Gunfire Shock Method.**

After examining requirements documents and applying the tailoring process in Part One of this Standard to determine where exposure to a gunfire shock environment is foreseen in the life cycle of the materiel, use the following to confirm the need for this Method and to place it in sequence with other methods.

2.1.1 Effects of a Gunfire Shock Environment.

Exposure to a gunfire shock environment has the potential for producing adverse effects on the structural and functional integrity of all materiel including in-service operational capability. The probability of adverse effects increases with the blast energy of the gun, proximity of the materiel to the gun, and the duration of the gunfire shock environment. The gunfire firing rate and the duration of gunfire shock environment exposure that correspond with natural frequencies of the mounted materiel (along with its sub-harmonics and super-harmonics) will magnify the adverse effects on the materiel's overall integrity.

MIL-STD-810H
METHOD 519.8**2.1.2 Sequence among Other Methods.**

- a. General. Use the anticipated life cycle sequence of events as a general sequence guide (see Part One, paragraph 5.5).
- b. Unique to this Method. Sequencing among other methods will depend upon the type of testing, i.e., design developmental, qualification, endurance, etc., and the general availability of test items. Normally, schedule gunfire shock tests early in the test sequence, but after significant levels of vibration, thermal, and mechanical shock tests. For thermal testing include any potential transient thermal effects from gunfire on the materiel. Note that in the Life Cycle Environmental Profile (LCEP) gunfire shock is represented as a series of events according to a “gunfire schedule,” such that the total exposure time is usually substantially less than exposure to random vibration environment(s).
 - (1) If the gunfire shock environment is deemed particularly severe and the chances of materiel survival without major structural and/or functional failure are small, perform the gunfire shock test first in the test sequence. This provides the opportunity to redesign the materiel to meet the gunfire shock requirement before testing to the potentially more benign vibration and/or mechanical shock environments.
 - (2) If the gunfire environment is considered severe, but the probability of the materiel survival without structural and/or functional failure is good, perform the gunfire shock test after vibration, thermal, and mechanical shock tests, allowing the stressing of the test item to long duration environments prior to gunfire shock testing. This order of testing is intended to uncover combined temperature and vibration/shock environmental failures. (There are often advantages to applying gunfire shock tests before climatic tests, provided the sequence represents realistic service conditions. Climate-sensitive defects often show up more readily after the application of severe gunfire shock environments. However, internal or external thermal stresses may permanently weaken materiel resistance to vibration, mechanical shock, and gunfire shock that may go undetected if gunfire shock tests are applied before climatic tests.)
 - (3) In cases in which the gunfire shock test levels are deemed less severe than the vibration test levels, the gunfire shock tests may be deleted from the testing sequence. However, credible modeling and analysis procedures must be employed that lead to concluding that gunfire shock levels are actually less severe than vibration test levels. This may require the predicted or measured gunfire shock environment be of the form of a short duration transient vibration with some periodic structure, as opposed to a replicated shock, and that the short duration transient vibration be analyzed in accordance with either stationary vibration procedures or procedures related to processing the product model for non-stationary environments.
 - (4) It is never acceptable to automatically conclude that gunfire shock test levels are less severe than mechanical shock test levels. Gunfire shock is of a repeated shock nature at the firing rate of the gun as opposed to a single mechanical shock. Methods for comparing the severity of shock, e.g., SRS, cannot be credibly used to assess the severity of test levels between gunfire shock and simple mechanical shock.
 - (5) The gunfire shock environment may affect materiel performance when materiel is tested simultaneously to other environmental conditions such as vibration, temperature, humidity, pressure, etc. If materiel is known to be sensitive to a combination of environments, test to those environments simultaneously (possibly superimposing the gunfire shock environment on the random vibration environment). If it is impractical to test to a combination of environments simultaneously, and where it is necessary to evaluate the effects of the gunfire shock environment together with other environments, expose a single test item to all relevant environmental conditions in turn. In general, gunfire shock may occur at any time during the specified operational conditions, so sequence it as close as practical to the sequencing defined in the life cycle environmental profile. If in doubt, as recommended in this paragraph, conduct gunfire shock testing immediately after completing any vibration and mechanical shock testing.

MIL-STD-810H
METHOD 519.8**2.2 Selecting a Procedure.**

This Method includes three procedures. Gunfire shock testing to significant environmental levels is generally limited by the guidelines provided in Method 525.2, Time Waveform Replication. In particular, all the guidelines in Method 525.2 relative to time trace scaling and simulation must be strictly adhered to. If the materiel, because of its distance from the gun, may be exposed to a gunfire shock environment even lower than measured vibration levels from other sources, separate testing to a gunfire shock environment may not be necessary to ensure materiel integrity. It is absolutely essential field measured time trace information representing particular materiel response to the gunfire shock environment be examined before guidelines found in Method 525.2 are applied. There are few, if any, reliable analytical techniques for accurately predicting low levels of materiel response to gunfire shock environment, except for obvious physical configuration assessment, e.g., the gun is on the opposite side of the aircraft fuselage from the materiel. Consider low gunfire shock environments as transient vibration environments rather than long duration stationary random vibration environments because of LCEP gunfire scheduling. Perform testing to transient vibration environments in accordance with Method 525.2. To execute laboratory testing this Method provides for the following three procedures:

Procedure I: MEASURED MATERIEL INPUT/RESPONSE TIME HISTORY UNDER TWR

Procedure II: SRS GENERATED SHOCK TIME HISTORY PULSE SEQUENCE UNDER TWR

Procedure III: STOCHASTICALLY GENERATED MATERIEL INPUT FROM PRELIMINARY DESIGN SPECTRUM UNDER TWR

2.2.1 Procedure Selection Considerations.

Based on test or preliminary design requirements, determine which test procedure, combination of procedures, or sequence of procedures is applicable. In many cases, one or more of the procedures will apply. For example, Procedure I may be the basis when measured gunfire response data are available. Procedure II will be required if measurement information is processed with the SRS as distinct shocks or as a SRS of the overall shock and measurement time history information is no longer available. If measurement time history information is available then Procedure I is recommended. For procedures in which there is a general lack of field measured data, Procedure III may be used to predict the gunfire repetitive shock environment and a gunfire shock time history produced under two ad hoc processes described in Procedure III. Consider all gunfire shock environments anticipated for the materiel during its life cycle, in its operational modes. When selecting procedures, consider:

- a. Measured Materiel Response Available. If field measured time trace materiel input/response data are available, it is recommended that this information be used in development of a test specification. Generally, the test specification will require that laboratory testing be in accordance with the guidelines provided in Method 525.2. Generally, Method 525.2 is the only method suitable for measured time traces that have the form of a repetitive shock at the firing rate of the gun over a given duration in the gunfire schedule.
- b. Measured Materiel Response Unavailable. If field measured time trace data for materiel are unavailable, the following considerations are important.
 - (1) First, there are no known reliable means of predicting gunfire shock materiel input/response based on gun and materiel configuration descriptions. Previous versions of MIL-STD-810 beginning with MIL-STD-810C provided a means of developing a predicted Sine-on-Random (SOR) vibration test spectrum based upon several gun/materiel configuration parameters. Information for predicting the SOR spectrum is thought to be too limited to be reliable.
 - (2) Second, it is recognized that in the early design and development of materiel, some guidance on levels of input excitation to the materiel are needed, and generally vibration or mechanical shock levels are not appropriate when significant materiel response to gunfire shock is anticipated.
 - (3) Third, the methodology for analysis of the measured response to gunfire shock was a major weakness in development of the predicted SOR spectrum. A SOR model is inadequate for modeling a repetitive pulse environment. The primary inadequacy in the modeling is the accurate representation of the repetitive pulse rise time. Four harmonically-related sine components added to stationary random vibration provide for a consistent rise time well below that for a repetitive shock environment, and appear to be too long for significant gunfire shock input excitation or even measured materiel response. Recent gunfire shock measurement data reveals substantial rise time

MIL-STD-810H
METHOD 519.8

responses and the sensitivity of the form of a single gunfire shock time trace to gun/materiel configuration.

- (4) Finally, there is a methodology that allows use of the predicted SOR spectrum information in the form of a repetitive pulse. This methodology requires preliminary design procedures be in accordance with that for repetitive shock at predicted SOR spectrum levels. This philosophy has been adopted for the stochastic prediction incorporated in Procedure III.

As a rationale related note on Procedure III, even though the set of measured data available in the mid-1970s was small for the extended prediction philosophy that was developed, there was hesitation in discarding the information in previous versions of MIL-STD-810. Accordingly (in light of the unavailability of other information to confirm the prediction methodology), use of the predicted information (SOR spectrum) in the form of a repetitive shock for preliminary design purposes, is acceptable. Part of the reasoning behind this is that the predicted information tends to scale correctly from a strictly logical point of view. Annex C provides guidelines for specifying preliminary repetitive shock based design environments from the prediction algorithm provided in this Annex. The materiel designer must be prepared to design to a form of repetitive shock input to the materiel at the gunfire rate.

It is assumed in applying any of the three procedures, the dynamics of the materiel are well known; in particular, the resonances of the materiel and the relationship of these resonances to the gun firing rate and its harmonics. In addition, it is assumed that any vibration/shock isolation characteristics between gun and materiel configuration are understood. Improper test procedure selection and execution may result in either a non-conservative materiel under-test, or a substantial materiel over-test. These procedures can be expected to cover a substantial range of testing related to materiel exposed to gunfire shock environment. In summary:

For severe materiel response to gunfire shock environment with measured time trace data, use Procedure I or Procedure II in conjunction with Method 525.2.

For benign materiel response to gunfire determined from measured time trace data, examine the need for testing to gunfire shock when other vibration or mechanical environments are prescribed. If the need persists, consider testing to a transient vibration environment under the guidelines in Method 525.2.

For no measured materiel response time history data, use the methodology outlined in Procedure III to predict preliminary gunfire repetitive shock levels and in an ad hoc manner generate repetitive shock time histories.

- c. The operational purpose of the materiel. From requirement documents, determine the operations or functions to be performed by the materiel before, during, and after exposure to the gunfire shock environment.
- d. The natural exposure circumstances. Materiel response to a gunfire shock environment is heavily dependent upon the caliber of the gun and the physical configuration of the gun relative to the materiel.
- e. Data required. The test data required to document the test environment and to verify the performance of the materiel before, during, and after the test.
- f. Procedure sequence. Refer to paragraph 2.1.2.

2.2.2 Difference among Procedures.

- a. **Procedure I. MEASURED MATERIEL INPUT/RESPONSE TIME HISTORY UNDER TWR.** Measured in-service gunfire shock environment for materiel is replicated under laboratory exciter waveform control (Method 525.2 TWR) to achieve a near exact reproduction of the measured in-service gunfire shock environment. Test philosophy includes selection of the time trace or traces to be replicated according to the scope of the test. Use the guidelines provided in Annex A and in Method 525.2.
- b. **Procedure II. SRS GENERATED SHOCK TIME HISTORY PULSE SEQUENCE UNDER TWR.** This procedure is based on former processing measured gunfire shock in terms of the SRS applied either to individual gunfire pulses or the SRS applied to the overall gunfire pulse sequence (it is assumed that time history

MIL-STD-810H
METHOD 519.8

information is no longer available for application of Procedure I). It is critical that percent of critical damping considered in computation of the SRS is known. The gunfire rate of interest must also be defined. The gunfire rate will define a parameter T_e . Ideally, the “concentration of energy”, T_E will also be provided (see Method 516.8 for a discussion of T_e and T_E). If the SRS is applied to individual gunfire pulses some form of “enveloping” the individual SRS estimates may be employed as described in Method 516.8 Annex B. In either case a single SRS estimate is obtained that can be used to generate a single shock pulse time history based upon waveform synthesis or other technology. This single shock pulse time history then can be concatenated into a shock pulse series and run under TWR. Stochastic variations with departures from single pulse generation are permitted.

- c. **Procedure III. STOCHASTICALLY GENERATED MATERIEL INPUT FROM PRELIMINARY DESIGN SPECTRUM UNDER TWR.** This procedure is ad hoc, lacking necessary field measured time trace information, and a last resort to providing guidelines for design of materiel to resist a gunfire shock environment. Only time trace forms for design are given, and it is not suggested that testing be performed to these forms for materiel qualification purposes. The shortcomings of previous MIL-STD-810 versions and use of prediction methods are outlined in paragraph 2.2.1. The inability to develop a database useful for prediction is unfortunate, and the reluctance to discard what little prediction information that is available has resulted in this procedure. The idea behind this procedure is that the true nature of either air-borne or structure-borne gunfire shock is impulsive in nature at the gunfire rate. Any initial design of materiel must be on the basis of a repetitive shock pulse as opposed to stationary random vibration with added sine components. Annex C provides an outline of limited procedures that stochastically generate pulse time traces for preliminary design when no measured gunfire shock information is available.

2.3 Determine Test Levels and Conditions.

Having selected this Method and relevant procedure(s) (based on the materiel’s requirements documents and the tailoring process), complete the tailoring process by identifying appropriate parameter levels, applicable test conditions, and test techniques for the selected procedures. Base these selections on the requirements documents and the LCEP, and information provided with this procedure. Consider the following when selecting test levels.

2.3.1 General Considerations.

Establish the test severities using available measured gunfire shock time trace data from a similar gun/materiel configuration, or measured gunfire shock time trace data acquired directly from an environmental measurement program. When these data are not available, some limited information on test severities and guidance may be found in Annex C. The procedure selected may not provide an adequate test for the complete environment; thus, a supporting assessment may be necessary to compliment the test results.

2.3.2 Test Conditions.

In all cases care must be taken to replicate the measured environmental materiel response data that may require establishing the correct interface impedances. When measured data are not available, the input to the materiel or the materiel response must be in accordance with that defined in Procedure III for prediction. Many laboratory shock tests are conducted under standard ambient test conditions as discussed in Part One, paragraph 5. However, when the life cycle events being simulated occur in environmental conditions significantly different than standard conditions, consider applying those environmental factors during testing.

2.3.3 Test Axes and Number of Gunfire Shock Events.

The test axes should be in accordance with the physical configuration for the in-service environment. Material response to gunfire pressure pulses will generally involve testing in axes normal to the primary pressure pulse emanation axis. Materiel response to structure-borne vibration will generally involve testing in all axes. The number of gunfire events should be in accordance with the Life-Cycle Environmental Profile document. In general, it is permissible to test using Single-Exciter/Single-Axis (SESA), Method 525.2 (TWR) methodology in all axes of concern. However, for particularly sensitive materiel whereby the operational integrity of the materiel must be ensured with a high degree of confidence, testing may be performed under the guidelines of Multiple-Exciter/Multiple-Axis (MEMA) methodology given under Method 527.2. Under highly specialized conditions, when materiel degradation under gunfire shock is very likely, it may be necessary to consider multiple gunfire events according to LCEP gunfire schedules modeled probabilistically as Poisson in nature, with either a stationary or non-stationary gunfire event rate.

MIL-STD-810H
METHOD 519.8

Generally, because of the unique character of gunfire shock, it is not acceptable to “scale” individual measured gunfire time traces in the time domain in order to achieve test conservativeness and reduce test repetitions. However, for frequency domain ensembles of a set of gunfire time histories e.g., a SRS ensemble, it is possible to summarize the ensemble in the frequency domain and use the summary to create an acceptable laboratory test time history for TWR. Generally, the created laboratory test time history will be distinct from measurements forming the ensemble but representative of what might possibly be a future measurement.

2.4 Test Item Configuration. (See Part One, Paragraph 5.8.)

Configure the test item for gunfire shock testing as would be anticipated during in-service use, including particular attention to the details of the in-service mounting of the materiel to the platform. Gunfire response is sensitive to the details of the materiel/platform configuration and input impedances.

2.5 Controls.

The dynamic excitation is controlled to within specified bounds by sampling the dynamic response of the test item at specific locations. These locations may be at, or in close proximity to the materiel fixing points (controlled input tests), or at defined points on the materiel (controlled response tests). For this Method, either (1) the test excitation is significant and controlled under TWR test methodology (Method 525.2 for SESA or Method 527.2 for MEMA), or (2) the test excitation is benign and controlled under either standard random vibration test methodology (Method 514.8 with application of the information in reference e for upper limit determination strategies).

2.5.1 Control Options.**2.5.1.1 Open/Closed Loop**

For significant gunfire shock environments (and possibly benign transient vibration environments), the test for any of the procedures is typically of short duration, and is performed after appropriate compensation of the exciter analog voltage input drive waveform. Longer sequences of gunfire events may be controlled in a closed loop mode under TWR. (For example, the “real-time” control offered under TWR software). All testing is in accordance with guidelines in Method 525.2 (SESA) or Method 527.2 (MEMA). For benign gunfire environments, not considered as transient vibration, the test for any of the procedures is performed in a closed loop spectrum control in accordance with guidelines in Method 514.8 (SESA) or Method 527.2 (MEMA).

2.5.1.2 Single Point Control.

Single point control SESA is a minimum requirement for all procedures. For significant gunfire shock environments, select a single point to represent the materiel fixing point from which the field-measured data were obtained, or upon which predictions are based. Tolerance specification is developed around a comparison between the “reference” time trace (measured or stochastically generated), and the “control” time trace measured in the laboratory. All testing is in accord with the guidelines of Method 525.2. For benign non-transient vibration gunfire environments, follow guidelines provided in Method 514.8 using single point spectrum control. It is highly recommended that additional measurement channels be employed in the vicinity of the control point for comparison purposes to minimize single point calibration errors.

2.5.1.3 Multiple Point Control.

Where multiple axis information is available then multiple axis TWR (MEMA) may be performed where the materiel is of an extended nature, and measurements at multiple points are needed to ensure the integrity in the reproduction of the environment. All testing should be performed under the guidelines of Method 527.2 for multi-exciter testing under TWR. For benign non-transient gunfire environments, follow guidelines provided in Method 527.2 for MEMA spectrum control.

2.5.2 Control Methods.**2.5.2.1 Waveform Control.**

Perform significant gunfire shock environment testing for all three procedures using TWR guidelines provided in Method 525.2 (SESA) or Method 527.2 (MEMA).

2.5.2.2 Spectrum Control.

Benign non-transient vibration gunfire environment testing is to be performed using standard random vibration guidelines provided under Method 514.8 (SESA) or Method 527.2 (MEMA).

MIL-STD-810H
METHOD 519.8**3. INFORMATION REQUIRED.****3.1 Pretest.**

The following information is required to conduct a gunfire test for a significant gunfire shock environment. (In this section SESA is assumed, however obtain the same pretest information if MEMA testing is required, and Method 527.2 MEMA is substituted for Method 525.2 SESA. In addition, if the gunfire environment is benign non-transient vibration, see Method 514.8 for SESA or Method 527.2 for MEMA spectrum control.).

- a. General. Information listed in Part One, paragraphs 5.7, 5.8, and 5.9; and Annex A, Task 405 of this Standard.
- b. Specific to this Method.
 - (1) Knowledge of the test fixture, test item, and combined test fixture/test item modal frequencies, and their relationship to the gunfire rate. Ideally, this would consist of an experimental modal survey for the test configuration including fixturing. If this is not practical, a supporting analytical assessment of the modal characteristics of the test configuration needs to be developed and interpreted by a trained analyst.
 - (2) Gunfire environment according to the gunfire schedule defining the number of individual firing events. Either:
 - (a) Measured time traces that are input directly as compensated waveforms into an exciter system under TWR control Method 525.2 (SESA) (Method 527.2 MEMA) for Procedure I.
 - (b) Time traces generated based on SRS reference criteria as compensated waveforms into an exciter system under TWR control Method 525.2 (SESA) (Method 527.2 MEMA) for Procedure II.
 - (c) Measured gun/materiel mechanical and geometrical parameters that have been specified, and predicted SOR spectrum derived. The predicted SOR form of spectrum is then used to generate a repetitive shock time trace input to the materiel at the gunfire rate.
 - (3) Techniques used in the processing of the input, and the materiel response data including means of satisfying the prescribed tolerance limits.
 - (4) An analog anti-alias filter configuration will be used that will:
 - (a) Not alias more than a 5 percent measurement error into the frequency band of interest.
 - (b) Have linear phase-shift characteristics in the data passband.
 - (c) Have a passband uniform to within one dB across the frequency band of interest (see paragraph 4.3).
 - (5) In subsequent processing of the data, use any additional filtering that is compatible with the anti-alias analog filtering. In particular, additional digital filtering must maintain phase linearity for processing gunfire time traces for Procedure I. In checking for test tolerance satisfaction, use the principles outlined in Method 525.2 - in particular, bandpass filter the control time trace to the bandwidth of the reference time trace or, alternatively, match the bandpass filter characteristics of the control time trace to the measured time trace.
 - (6) Generally, there are three bandwidths of concern: (1) the field measured time trace bandwidth based upon the instrumentation signal conditioning configuration, (2) the reference time trace to be used in testing (5 Hz to 2kHz), and (3) the measured control time trace from the test that may have energy exceeding 2kHz. Test tolerance procedures must compare common bandwidth information. Common bandwidths may be established by digital filtering between either (1) the field measured time trace and the measured test control time trace, or (2) the test reference time trace and the bandlimited control time trace. The procedures for establishing common bandwidths are provided in Method 525.2.
 - (7) For all Procedures, the measured or generated time history trace should be over-sampled by a factor of 10. Ideally, for 2 kHz data, a sample rate of 20,480 (with a linear phase anti-alias filter set at

MIL-STD-810H
METHOD 519.8

2.5 kHz) will be suitable. For spectral computations, a maximum 5 Hz analysis filter bandwidth is recommended.

- (8) Analysis procedures will be in accordance with those requirements and guidelines provided in paragraph 6.1, reference a. In particular, the test item response acceleration time histories will be qualified according to the procedures in paragraph 6.1, reference b. In severe cases of response acceleration, it may be necessary that each time history be integrated to detect any anomalies in the measurement system, e.g., cable breakage, amplifier slew-rate exceedance, data clipped, unexplained accelerometer offset, etc. The integrated amplitude time histories will be compared against criteria given in paragraph 6.1, reference b.
- c. Tailoring. Necessary variations in the basic test procedures to accommodate LCEP requirements.

3.2 During Test.

Collect the following information during conduct of the gunfire test for a significant gunfire shock environment. (In this section SESA is assumed, however obtain the same test information if MEMA testing is required and Method 527.2 MEMA (TWR) is substituted for Method 525.2 SESA. In addition, if the gunfire environment is benign and non-transient vibration, see Method 514.8 for SESA, or Method 527.2 for MEMA spectrum control).

- a. General. Information in Part One, paragraph 5.10; and in Part One, Annex A, Task 405 and 406 of this Standard.
- b. Specific to this Method. Information related to failure criteria. Other environmental conditions at which testing is to be carried out if other than at standard laboratory conditions, and the specific features of the test assembly (exciter, fixture, interface connections, etc.). For test validation purposes, record achieved test parameters, deviations from pre-test procedures including parameter levels, any procedural anomalies, and any test failures. Save in digital form the reference, control, and monitoring acceleration time traces for post-test processing, including test tolerance verification, under the guidelines provided in Method 525.2.

3.3 Post-Test.

The following post test data shall be included in the test report. (In this section SESA is assumed; however, obtain the same pretest information if MEMA testing is required, and Method 527.2 MEMA TWR is substituted for Method 525.2 SESA. In addition, if the gunfire environment is benign and non-transient vibration, see Method 514.8 for SESA or Method 527.2 for MEMA spectrum control).

- a. General. Information listed in Part One, paragraph 5.13; and in Annex A, Task 406 of this Standard.
- b. Specific to this Method.
- (1) Duration of each exposure and number of exposures.
 - (2) Functional and physical integrity of the test item after each test based upon operational testing and visual examination.
 - (3) Reference, control, and monitor time traces along with the information processed from these time traces to ensure test tolerances were met in the course of testing (see Method 525.2).
 - (4) Results of operational checks.
 - (5) Test item and/or fixture modal analysis data.

MIL-STD-810H
METHOD 519.8

4. TEST PROCESS.

4.1 Test Facility.

Prior to initiating any testing, review the pretest information in the test plan to determine test details (e.g., procedure, calibration load (dynamically similar materiel testing using a dynamic simulant for test waveform compensation), test item configuration, measurement configuration, gunfire level, gunfire duration, number of repetitions of gunfire event to be applied). Examine all details of the test validation procedures. Use fixturing that simulates actual in-service mounting attachments (including vibration isolators and fastener torque, if appropriate). Install all the connections (cables, pipes, etc.) in a way that they impose stresses and strains on the test item similar to those encountered in service. In certain cases, consider the suspension of the test item for low frequency apparatus to avoid complex test fixture resonances that may coincide with measured materiel gunfire response resonant frequencies.

For significant gunfire shock environments, use a test facility, including all auxiliary equipment, capable of providing the specified gunfire materiel response environments within the tolerances stated in paragraph 4.2. This will require a test facility with vendor supplied Time Waveform Replication capability able to perform testing in accordance with guidelines provided in either Method 525.2 or Method 527.2. In addition, use measurement transducers, data recording, and data reduction equipment capable of measuring, recording, analyzing, and displaying data sufficient to document the test and to acquire any additional data required. Unless otherwise specified, perform the specified gunfire tests and take measurements at standard ambient conditions as specified in Part One, paragraph 5.1. For benign non-transient vibration gunfire environments, any test facility capable of meeting the test guidelines in Method 514.8 (SESA) or Method 527.2 (MEMA) spectrum control will be suitable.

4.2 Controls.

In general, acceleration will be the quantity measured to meet a specification, with care taken to ensure acceleration measurements can be made that provide meaningful data. Always give special consideration to the measurement instrument amplitude and frequency range specifications in order to satisfy the calibration, measurement and analysis requirements. With regard to measurement technology, accelerometers, strain gages, and laser Doppler vibrometers are commonly used devices for measurement. In processing shock data, it is important to be able to detect anomalies. For example, it is well documented that piezoelectric accelerometers may offset or zero-shift during mechanical shock, pyroshock, and ballistic shock (paragraph 6.1, references h and i). A part of this detection is the integration of the acceleration amplitude time history to determine if it has the characteristics of a physically realizable velocity trace. For mechanical shock various accelerometers are readily available which may or may not contain mechanical isolation. All measurement instrumentation must be calibrated to traceable national calibration standards (see Part One, paragraph 5.3.2). In addition, instrumentation to measure test item function may be required. In this case, obtain suitable calibration standards and adhere to them.

a. Accelerometers. Ensure the following:

- (1) Amplitude Linearity: It is desired to have amplitude linearity within 10 percent from 5 percent to 100 percent of the peak acceleration amplitude required for testing. Since mechanically isolated piezoelectric accelerometers (mechanically isolated or not) may show zero-shift (paragraph 6.1, reference j), there is risk to not characterizing these devices at 5 percent of the peak amplitude. To address these possible zero-shifts, high pass filtering (or other data correction technique) may be required. Such additional post-test correction techniques increases the risk of distorting the measured shock environment. Consider the following in transducer selection:
 - (a) It is recognized that mechanically isolated accelerometers may have both non-linear amplification and non-linear frequency content below 10,000 Hz (paragraph 6.1, reference j). In order to understand the non-linear amplification and frequency characteristics, it is recommended that shock linearity evaluations be conducted at intervals of 20 to 30 percent of the rated amplitude range of the accelerometer to identify the actual amplitude and frequency linearity characteristics and useable amplitude and frequency range. If a shock based calibration technique is employed, the shock pulse duration for the evaluation is calculated as:

$$T_D = \frac{1}{2f_{\max}}$$

MIL-STD-810H
METHOD 519.8

Where T_D is the duration (baseline) of the acceleration pulse and f_{max} is the maximum specified frequency range for the accelerometer. For mechanical shock, the default value for f_{max} is 10,000 Hz.

- (b) For cases in which response below 2 Hz is desired, a piezoresistive accelerometer measurement is required.
 - (2) Frequency Response: A flat response within ± 5 percent across the frequency range of interest is required. Since it is generally not practical or cost effective to conduct a series of varying pulse width shock tests to characterize frequency response, a vibration calibration is typically employed. For the case of a high range accelerometer with low output, there may be SNR issues associated with a low level vibration calibration. In such cases a degree of engineering judgment will be required in the evaluation of frequency response.
 - (3) Accelerometer Sensitivity: The sensitivity of a shock accelerometer is expected to have some variance over its large amplitude dynamic range.
 - (a) If the sensitivity is based upon the low amplitude vibration calibration, it is critical that the linearity characteristics of the shock based "Amplitude Linearity" be understood such that an amplitude measurement uncertainty is clearly defined.
 - (b) Ideally, vibration calibration and shock amplitude linearity results should agree within 10 percent over the amplitude range of interest for a given test.
 - (4) Transverse sensitivity should be less than or equal to 5 percent.
 - (5) The measurement device and its mounting will be compatible with the requirements and guidelines provided in paragraph 6.1, reference b.
 - (6) Unless it is clearly demonstrated that a piezoelectric accelerometer (mechanically isolated or not) can meet the shock requirements and is designed for oscillatory shock (not one-sided shock pulses), recommend piezoresistive accelerometers be used for high intensity shock events in which oscillatory response is anticipated. Piezoelectric accelerometers may be used in scenarios in which levels are known to be within the established (verified through calibration) operating range of the transducer, thereby avoiding non-linear amplification and frequency content.
- b. Other Measurement Devices.
- (1) Any other measurement devices used to collect data must be demonstrated to be consistent with the requirements of the test, in particular, the calibration and tolerance information provided in paragraph 4.2.
 - (2) Signal Conditioning. Use only signal conditioning that is compatible with the instrumentation requirements of the test, and is compatible with the requirements and guidelines provided in paragraph 6.1, reference b. In particular, filtering of the analog voltage signals will be consistent with the time history response requirements (in general, demonstrable linearity of phase throughout the frequency domain of response), and the filtering will be so configured that anomalous acceleration data caused by clipping will not be misinterpreted as response data. In particular, use extreme care in filtering the acceleration signals at the amplifier output. Never filter the signal into the amplifier for fear of filtering erroneous measurement data, and the inability to detect the erroneous measurement data. The signal from the signal conditioning must be anti-alias filtered before digitizing (see Method 516.8 Shock Annex A).

The complete test parameter control chains (checking, compensation, servings, recording, etc.) should not produce uncertainties exceeding one third of the tolerances specified in paragraphs 4.2.1 through 4.2.4. Because of the nature of the gunfire environment, tolerances may be given in the time, amplitude, and frequency domain according to the processing requirements of the procedure. Knowledge of the bandwidth of the reference and control time traces will be important, and an assessment of the out-of-band energy provided by limitations of impedance matching and fixture resonances will be important. In Procedures I and II, it is assumed that the test item response measurement data collected are representative of the true environment, and not a function of the local materiel configuration, e.g., local resonances that may not be controllable to the tolerances in paragraphs 4.2.1 through 4.2.4. Use test fixturing that will ensure test item response in other axes does not exceed twenty-five percent of the test item response in the test axis

MIL-STD-810H
METHOD 519.8

when measured in the time, amplitude, or frequency domain. Methods 525.2 and 527.2 provide guidelines on test tolerance specification under TWR and, in most cases, these test tolerances will be adequate for gunfire testing. The test tolerance guidelines provided below assume stochastic ensemble processing formulation, whereby there is variation in time, but the frequency domain content remains the same over the ensemble of pulses. These test tolerance guidelines may be superseded by more time trace form appropriate guidelines in Methods 525.2 or 527.2. In conjunction with satisfaction of test tolerances, a dynamic simulant for the test materiel is initially recommended to compensate the input waveform. In addition, an appropriate time trace compensation strategy may be applied to optimize the TWR input to the stimulant, and applied in subsequent testing of the materiel.

4.2.1 MEASURED MATERIEL INPUT/RESPONSE TIME HISTORY UNDER TWR (PROCEDURE I)

- a. Time domain. Generally, reference and control time traces are perfectly correlated so that there is no requirement under Method 525.2.
- b. Amplitude domain. Ensure materiel time history major positive and negative response peaks are within ± 10 percent of the measured gunfire time history peaks. Ensure the root-mean-square level of the point-by-point difference between the control and reference time traces is less than ± 5 percent of the combined control/reference peak time traces for a short-time average time not to exceed 10 percent of the gun fire rate.
- c. Frequency domain. Compute a low frequency resolution average Energy Spectral Density (ESD) estimate over the ensemble created from the materiel time history response that is within ± 3 dB of the average ESD estimate computed over the ensemble created from the measured gunfire time history over at least 90 percent of the frequency range. In cases in which an ensemble from the data cannot be created, compute an ASD estimate of the time history records for comparison, provided the data are appropriately windowed (usually with a 10 percent tapered cosine window, a Kaiser window or frequency averaging) to reduce spectral leakage. The tolerances for the ASD analysis are ± 3 dB over at least 90 percent of the frequency range. In addition require that overall root-mean-square levels are within 10 percent.

4.2.2 SRS GENERATED SHOCK TIME HISTORY PULSE SEQUENCE UNDER TWR (PROCEDURE II)

- a. Time domain. Ensure the duration of every generated pulse is within 2.5 percent of the duration obtained from the predicted gunfire rate if stochastic ensemble generation methodology is implemented. Ensure the duration of the gun firing event is within 0.5 percent of the overall duration if the stochastic time trace generation methodology is implemented.
- b. Amplitude domain. Ensure materiel time history major positive and negative response peaks are within ± 10 percent of the predicted gunfire time history peaks. Ensure that the root-mean-square level of the point-by-point difference between the control and reference time traces is less than ± 5 percent of the combined control/reference peak time traces for a short-time average time not to exceed 0.1 of the gunfire pulse period.
- c. Frequency domain. For a reference synthesized pulse time history trace based on a SRS, compute the SRS of a representative pulse or series of pulses and compare to classical SRS tolerances addressed in Method 516.8.

4.2.3 STOCHASTICALLY GENERATED MATERIEL INPUT FROM PRELIMINARY DESIGN SPECTRUM UNDER TWR (PROCEDURE III)

If this procedure requires follow-on testing only time and frequency domain requirements are used.

- a. Time domain. Ensure the duration of every generated pulse is within 2.5 percent of the duration obtained from the specified gunfire rate.
- b. Frequency domain. Ensure the SOR spectrum developed for the pulses is within ± 3 dB of the predicted SOR spectrum over the entire frequency band of interest. In general, this will be based upon an estimate of the ASD from which the Time Domain Windowed Pulse (TDWP) or Random-Modulated-Harmonic-Pulse (RMHP) are created.

4.3 Test Interruption.

If interruption occurs during gunfire shock test input, repeat that gunfire shock test input. Ensure stresses induced by the interrupted gunfire shock test do not invalidate subsequent test results. It is incumbent on all test facilities that data

MIL-STD-810H
METHOD 519.8

from such interruptions be recorded and analyzed before continuing with the test sequence. In the case of any interruption, the test item must be re-inspected prior to restarting the test to ensure test item integrity.

Test interruptions can result from two or more situations, one being from failure or malfunction of associated laboratory test equipment. The second type of test interruption results from failure or malfunction of the test item itself during required or optional performance checks.

4.3.1 Interruption from Failure or Malfunction of Associated Laboratory Test Equipment.

- a. General. See Part One, paragraph 5.11 of this Standard.
- b. Specific to this Method. If there is an unscheduled interruption, restore/replace laboratory test equipment and reinitiate the test being conducted at the time of failure or malfunction using the same test item.

4.3.2 Interruption Due To Test Item Operation Failure.

Failure of the test item(s) to function as required during mandatory or optional performance checks during testing presents a situation with several possible options.

- a. The preferable option is to replace the test item with a “new” one and restart from Step 1.
- b. A second option is to replace / repair the failed or non-functioning component or assembly with one that functions as intended, and restart the entire test from Step 1.

NOTE: When evaluating failure interruptions, consider prior testing on the same test item and consequences of such.

4.4 Test Execution.

The following actions along with steps, alone or in combination, provide the basis for collecting necessary information concerning the durability and function of a test item in a gunfire shock environment.

4.4.1 Preparation for Test.

4.4.1.1 Pretest Checkout.

After appropriate compensation of the excitation input device (with possibly a dynamic simulant), and prior to conducting the test, perform a pretest checkout of the test item at standard ambient conditions to provide baseline data. Conduct the checkout as follows:

- Step 1 Conduct a complete visual examination of the test item with special attention to stress areas or areas identified as being particularly susceptible to damage and document the results.
- Step 2 Install the test item in its test fixture.
- Step 3 Conduct a test item operational check in accordance with the approved test plan, along with simple tests for ensuring the response measurement system is responding properly. If the test item operates satisfactorily, proceed to the appropriate procedure. If not, resolve the problems and repeat this Step. Document the results for compliance with information contained in Part One, paragraph 5.9.
- Step 4 If the test item integrity has been verified, proceed to the first test. If not, resolve the problem and restart at Step 1.

4.4.1.2 Procedure Overview.

Paragraphs 4.4.2 through 4.4.4 provide the basis for collecting the necessary information concerning the test item in a gunfire shock environment. For failure analysis purposes, in addition to the guidance provided in Part One, paragraph 5.14, each procedure contains information to assist in the evaluation of the test results. Analyze any failure of a test item to meet the requirements of the system specifications based on the guidelines in Part One, paragraph 5.14. For test interruption, follow the guidelines in paragraph 4.3.

MIL-STD-810H
METHOD 519.8**4.4.1.3 Test Item Considerations.**

Test items can vary from individual materiel items to structural assemblies containing several items of materiel of different types.

- a. General. Unless otherwise specified in the individual test plan, attach the test item to the vibration exciter by means of a rigid fixture capable of transmitting the repetitive shock conditions specified. Ensure the fixture inputs repetitive shock to racks, panels, and/or vibration isolators to simulate as accurately as possible the repetitive shock transmitted to the materiel in service and to the measured gunfire shock environment. When required, ensure materiel protected from repetitive shock by racks, panels, and/or vibration isolators also passes the appropriate test requirements with the test item hard-mounted to the fixture.
- b. Subsystem testing. When identified in the test plan, subsystems of the materiel may be tested separately. The subsystems can be subjected to different gunfire shock environment levels according to the measured time trace data. In this case, ensure the test plan stipulates the gunfire shock levels from measured time trace data specific to each subsystem.
- c. Test item operation. Refer to the test plan to determine whether the test item should be in operation. Because continuous gunfire shock testing can cause unrealistic damage to the test item (e.g., unrealistic heating of vibration isolators), interrupt the excitations by periods of rest defined by the test plan and in accordance with the LCEP.

4.4.2 Procedure I - MEASURED MATERIEL INPUT/RESPONSE TIME HISTORY UNDER TWR**4.4.2.1 Controls.**

This procedure assumes that measured materiel input/response data are available in digital form, and this input/response data will be replicated in the laboratory on the test item. This procedure may include the concatenation of several files of measured reference time traces.

4.4.2.2 Test Tolerances.

Ensure test tolerances are in accordance with those specified in paragraph 4.2.

4.4.2.3 Procedure Steps.

- Step 1 Precondition the test item in accordance with paragraphs 4.2 and 4.4.1.
- Step 2 Choose control strategy and control and monitoring points in accordance with paragraph 2.5.
- Step 3 Perform operational checks in accordance with paragraph 4.4.1.
- Step 4 Mount the test item on the vibration exciter or use some other means of suspension in accordance with paragraph 4.4.4.1.
- Step 5 Determine the time trace representation of the vibration exciter drive signal required to provide the desired gunfire shock materiel acceleration input/response on the test item. (Refer to Annex A.)
- Step 6 Apply the drive signal as an input voltage, and measure the test item acceleration response at the selected control/monitoring point.
- Step 7 Verify that the test item response is within the allowable tolerances specified in paragraph 4.2.1.
- Step 8 Apply gunfire shock simulation for on and off periods and total test duration in accordance with the test plan. Perform operational checks in accordance with the test plan. If there is failure in test item operational performance, stop the test, assess the failure, and decide upon the appropriate course of action to proceed with testing to complete the test plan. Follow the guidance in paragraph 4.3.2.
- Step 9 Repeat the previous steps along each of the other specified axes, and record the required information.

4.4.2.4 Analysis of Results.

Refer to the guidance in Part One, paragraph 5.14, to assist in the evaluation of the test results. In addition, a display of the measured test item response time trace and analysis called for in paragraph 4.2.1 to satisfy the test tolerances.

MIL-STD-810H
METHOD 519.8**4.4.3 Procedure II - SRS GENERATED SHOCK TIME HISTORY PULSE SEQUENCE UNDER TWR****4.4.3.1 Controls.**

This procedure assumes that generated input/response data are available in digital form, has been deterministically modeled after the SRS procedure described in Method 516.8 and the generated sample function input/response data will be replicated in the laboratory on the test item.

4.4.3.2 Test Tolerances.

Ensure test tolerances are in accordance with those specified in paragraph 4.2.

4.4.3.3 Procedure Steps.

- Step 1 Generate a deterministic representation of the field measured materiel input/response data. In general, this will involve an off-line procedure designed to generate an ensemble of deterministic pulses based on measured data for input to the vibration exciter as a single time trace of concatenated pulses or a single deterministic time trace (refer to Annex B).
- Step 2 Precondition the test item in accordance with the test plan.
- Step 3 Choose control strategy and control and monitoring points in accordance with paragraph 2.5.
- Step 4 Perform operational checks in accordance with paragraph 4.4.4.1.
- Step 5 Mount the test item on the vibration exciter (or use some other means of suspension) in accordance with paragraph 4.4.4.1.
- Step 6 Determine the time trace representation of the vibration exciter drive signal required to provide the desired gunfire shock materiel acceleration input/response on the test item.(Refer to Annex B).
- Step 7 Apply the drive signal as an input voltage, and measure the test item acceleration input/response at the selected control/monitoring point.
- Step 8 Verify that the test item response is within the allowable tolerances specified in paragraph 4.2.2.
- Step 9 Apply gunfire shock simulation for on and off periods, and total test duration in accordance with the test plan. Perform operational checks in accordance with the test plan. If there is failure in test item operational performance stop the test, assess the failure, and decide upon the appropriate course of action to proceed with testing to complete the test plan. Follow the guidance in paragraph 4.3.2.
- Step 10 Repeat the previous steps along each of the other specified axes, and record the required information.

4.4.3.4 Analysis of Results.

Refer to the guidance in Part One, paragraph 5.14, to assist in the evaluation of the test results. In addition, a display of the measured test item response time trace and analysis called for in paragraph 4.2.2 to satisfy the test tolerances.

4.4.4 Procedure III - STOCHASTICALLY GENERATED MATERIEL INPUT FROM PRELIMINARY DESIGN SPECTRUM UNDER TWR**4.4.4.1 Controls.**

This procedure assumes that the gun/materiel parameters are available for derivation of a predicted SOR test spectrum. This procedure also assumes given the predicted spectrum, a Time Domain Windowed Pulse or Random-Modulated-Harmonic-Pulse time trace can be developed having the same estimated spectrum with minimized harmonic distortion. Developing either the Time Domain Windowed Pulse (TDWP) or the Random Modulated Harmonic Pulse (RMHP) time trace requires a trained analyst and specialized software. It makes no provision for actual testing. For actual testing to the Time Domain Windowed Pulse or Random-Modulated-Harmonic-Pulse time trace use Procedure I as if stochastic simulation of a field measured environment has been performed.

- Step 1 Specify the gun/materiel parameters and generate the predicted SOR spectrum (See Annex C.)
- Step 2 Generate a Time Domain Windowed Pulse or Random-Modulated-Harmonic-Pulse time trace with the specified predicted spectrum.

MIL-STD-810H
METHOD 519.8

- Step 3 For materiel design considerations analyze the Time Domain Windowed Pulse or Random-Modulated-Pulse time trace according to procedures appropriate for a repetitive shock and use this analysis for consideration in preliminary materiel design. Typically:
- (a) Transient vibration root-mean-square peak levels along with a normalized ASD estimate will be used in specifying the acceleration environment for the materiel design
 - (b) Single pulse ASD or equivalently ESD estimates will be made on the response to the Time Domain Windowed Pulse or Random-Modulated-Pulse time trace (either under ensemble representation or as an overall time trace) and be used in specifying a gunfire shock environment for materiel design.
- Step 4 If testing is required, generate the equivalent Time Domain Windowed Pulse or Random Modulated Harmonic Pulse time trace environment (refer to Annex C.), and go to Procedure I for testing while recording the required information.

5. ANALYSIS OF RESULTS.

In addition to the guidance provided in Part One, paragraphs 5.14 and 5.17, Annex A, Task 406, refer to the “Analysis of results” paragraph in the front part of this Method. Analyze any failure of a test item to meet the requirements of the materiel specifications. In addition, a display of the measured test item response time trace and analysis as called for in paragraph 4.2 to satisfy the test tolerances.

6. REFERENCE/RELATED DOCUMENTS.

6.1 Referenced Documents.

- a. Piersol, Allan G., Determination of Maximum Structural Responses From Predictions or Measurements at Selected Points, Proceedings of the 65th Shock and Vibration Symposium, Volume I, SAVIAC, 1994. Shock & Vibration Information Analysis Center (SAVIAC), PO Box 165, 1104 Arvon Road, Arvon, VA 23004.
- b. Handbook for Dynamic Data Acquisition and Analysis, IEST-RD-DTE012.2, Institute of Environmental Sciences and Technology, Arlington Place One, 2340 S. Arlington Heights Road, Suite 100, Arlington Heights, IL60005-4516; Institute of Environmental Sciences and Technology.
- c. D. O. Smallwood, Characterization and Simulation of Gunfire with Wavelets, Proceedings of the 69th Shock and Vibration Symposium, Minneapolis, MN, October 1998.
- d. D. O. Smallwood, Characterization and Simulation of Gunfire with Wavelets, Shock and Vibration, Volume 6, November 2, 1998, IOS Press, The Netherlands.
- e. Merritt, Ronald G., “Assessment of Gunfire Environment under Cyclostationary Assumptions”, 78th Shock and Vibration Symposium, Philadelphia, PA, November 2007 (unpublished)
- f. MIL-STD-810C, Method 519.2, 10 March 1975.
- g. MIL-STD-810E, Method 519.4 14 July 1989.
- h. Chu, A., “Zeroshift of Piezoelectric Accelerometers in Pyroshock Measurements,” Proceedings of the 58th Shock & Vibration Symposium, Huntsville, AL, October 1987.
- i. Plumlee, R. H., “Zero-Shift in Piezoelectric Accelerometers,” Sandia National Laboratories Research Report, SC-RR-70-755, March 1971.
- j. Bateman, V. I., “Accelerometer Isolation for Mechanical Shock and Pyroshock,” Proceedings of the 82nd Shock and Vibration Symposium, Baltimore, MD, November, 2011 (paper) and ESTECH2012, Orlando, FL, May 2012.
- k. Hale, Michael T., “Synthesis of a Time History Based on the Sine-on-Random Prediction Methodology Defined in Mil-Std-810 Method 519,” Journal of the Institute of Environmental Sciences and Technology, V. 60, No. 1, pp 27-37, 2017.
- l. Merritt, Ronald G., “Aspects of the Random Modulated Harmonic Pulse (RMHP) for Gunfire Response Environment Laboratory Testing,” Scheduled for publication in the Proceedings of the IEST, 2019.

MIL-STD-810H
METHOD 519.8**6.2 Related Documents.**

- a. IEST RP on Gunfire - Institute of Environmental Sciences and Technology, Arlington Place One, 2340 S. Arlington Heights Road, Suite 100, Arlington Heights, IL60005-4516.
- b. NATO STANAG 4370, Environmental Testing. Allied Environmental Conditions, and Allied Environmental Conditions and Test Publication (AECTP) 400, Mechanical Environmental Tests, Method 405.
- c. Harris, C., and C. E. Crede, eds., Shock and Vibration Handbook, 5th Edition, NY, McGraw-Hill, 2000.
- d. Piersol, A.G., Analysis of Harpoon Missile Structural Response to Aircraft Launches, Landings and Captive Flight and Gunfire. Naval Weapons Center Report #NWC TP 58890. January 1977.
- e. J. S. Bendat and A. G. Piersol, Random Data: Analysis and Measurement Procedures, 3rd edition, John Wiley & Sons Inc., New York, 2000.
- f. Merritt, R. G., "A Note on Prediction of Gunfire Environment Using the Pulse Method," IEST, 40th ATM, Ontario, CA, May 1999. Institute of Environmental Sciences and Technology, Arlington Place One, 2340 S. Arlington Heights Road, Suite 100, Arlington Heights, IL60005-4516.
- g. R. G. Merritt, Simulation of Ensemble Oriented Nonstationary Processes, Part 2 Proceedings of 1994 IES 40th Annual Technical Meeting, Chicago, IL, May 1994; Institute of Environmental Sciences and Technology, Arlington Place One, 2340 S. Arlington Heights Road, Suite 100, Arlington Heights, IL60005-4516.
- h. D. O. Smallwood, Gunfire Characterization and Simulation Using Temporal Moments, Proceedings of the 65th Shock and Vibration Symposium, Volume 1, San Diego, CA, November 1994.
- i. R. G. Merritt, An Example of the Analysis of a Sample Nonstationary Time History, Proceedings of 1994 IES 40th Annual Technical Meeting, Chicago, IL, May 1994; Institute of Environmental Sciences and Technology, Arlington Place One, 2340 S. Arlington Heights Road, Suite 100, Arlington Heights, IL60005-4516.
- j. Merritt, R.G. and S.R. Hertz, Aspects of Gunfire, Part 1- Analysis, Naval Weapons Center, China Lake, CA93555-6100, NWC TM 6648, Part 1, October 1990.
- k. Merritt, R.G. and S.R. Hertz, Aspects of Gunfire, Part 2- Simulation, Naval Weapons Center, China Lake, CA93555-6100, NWC TM 6648, Part 2, September 1990.
- l. Egbert, Herbert W. "The History and Rationale of MIL-STD-810 (Edition 2)", January 2010; Institute of Environmental Sciences and Technology, Arlington Place One, 2340 S. Arlington Heights Road, Suite 100, Arlington Heights, IL60005-4516.

(Copies of Department of Defense Specifications, Standards, and Handbooks, and International Standardization Agreements are available online at <https://assist.dla.mil>).

Requests for other defense-related technical publications may be directed to the Defense Technical Information Center (DTIC), ATTN: DTIC-BR, Suite 0944, 8725 John J. Kingman Road, Fort Belvoir VA 22060-6218, 1-800-225-3842 (Assistance--selection 3, option 2), <http://stinet.dtic.mil/info/s-stinet.html>; and the National Technical Information Service (NTIS), Springfield VA 22161, 1-800-553-NTIS (6847), <http://www.ntis.gov/>.

MIL-STD-810H
METHOD 519.8

(This page is intentionally blank.)

MIL-STD-810H
METHOD 519.8 ANNEX A**METHOD 519.8, ANNEX A****GUIDELINES FOR PROCEDURE I - MEASURED MATERIEL INPUT/RESPONSE TIME HISTORY UNDER TWR****1. SCOPE.****1.1 Purpose.**

This Annex provides (1) pre-processing procedures for Method 525.2 (SESA) TWR laboratory test for gunfire shock environment, (2) an illustration of direct reproduction (in a laboratory test) of in-service measured materiel input/response time trace data on a force exciter under Method 525.2, (3) test tolerance limit assessment for guidelines provided in Method 525.2 and a rationale and procedure for stochastic generation of gunfire shock time traces from measured information. This annex assumes that the testing facility is fully qualified to perform the Single-Exciter/Single-Axis (SESA) Procedure in Method 525.2. For potential extensions of Procedure I to either Multi-Exciter/Single-Axis (MESA) or Multi-Exciter/Multi-Axis (MEMA), use guidelines in Method 527.2.

1.2 Application.

This procedure is essential for accurate time trace replication of single point input to materiel that may be characterized as an in-service measured gunfire shock. Because of the repetitive non-stationary nature of the gunfire shock environment, this is possibly the only known procedure that will provide precision in laboratory testing. Acceleration is considered the measurement variable in the discussion to follow, although other variables may be used, provided the dynamic range of the measured materiel response is consistent with the dynamic range of the force exciter used as the test input device. Testing is performed in order to ensure materiel physical and functional integrity during a specific measured gunfire shock event, and to provide confidence that materiel will demonstrate the same integrity under similar in-service events.

2. DEVELOPMENT.**2.1 Basic Considerations for Environmental Determination.**

In-service measured data collection is performed with properly instrumented materiel where the measurements are made at pre-selected points either as input to the materiel or as response from the materiel. If the measurement points are on the materiel then the measurement points exhibit minimum local resonances, yet the measurement locations will allow the detection of significant overall materiel resonances. The measurement locations may be determined prior to an in-service measurement effort by examination of random vibration data on the materiel using various accelerometer mounting locations and fixture configurations (the in-service measurement or reference point should be the same as the laboratory control point). The in-service measured data should be DC coupled (preferably), or at least high pass filtered below the most significant frequency that can be replicated in the laboratory. For an electrohydraulic exciter, information close to DC in the measurement time trace can be replicated, however, for an electrodynamic exciter measurement data high pass filtered above 5 Hz will be acceptable. The measurement time trace should be sampled at ten times the highest frequency of interest, with appropriate anti-alias filtering applied (this applies for either direct digital recording or digitizing an analog voltage signal from a recording device). The measured time history trace should be examined for any evidence of signal clipping, or any accelerometer performance anomalies, e.g., zero shifting. If there is indication of accelerometer measurement anomalies, the potentially corrupted acceleration time trace should be carefully examined according to the procedures used in validation of mechanical shock data (see paragraph 6.1 reference b). For example time trace integration to examine velocity and displacement characteristics and the computation of sample probability density function (PDF) estimates may provide information on invalid time traces. If there is no indication of accelerometer anomalies, digitally band pass filter the in-service measured time trace consistent with the exciter replication bandwidth, and place it in a digital file designated the reference time trace for TWR testing under Method 525.2 (SESA). This procedure for preparing the reference time trace for TWR is usually performed with a personal computer (PC) with signal processing capability. A test of gunfire shock replication on an electrodynamic exciter using Procedure I under guidelines in Method 525.2 is provided for illustration purposes below. Application of test tolerance assessment for Procedure I is illustrated.

2.2 Test Configuration.

A specially instrumented unidentified test item is installed in a laboratory vibration fixture and mounted on an electrodynamic exciter. The test item employed during the laboratory testing is of the same general materiel configuration that was used to collect the gunfire shock materiel response information during an in-service test

MIL-STD-810H
METHOD 519.8 ANNEX A

performed specifically for measurement data collection. The in-service test and laboratory replication included accelerometer measurement locations that were correlated.

2.3 Creating a Digital File of the Measured Gunfire Shock Input to the Materiel.

A first step is to formulate a test strategy and carefully examine the available measured time trace information designed to satisfy the test strategy. Usually, selection of a test strategy is based upon the materiel LCEP. The test strategy may consist of selection of the maximum measured environment for replication according to some criteria, e.g., peak acceleration, maximum energy, etc. The test strategy may also consist of selection of several levels of measured environment to be run sequentially in proportion to the level of the particular environment expected in the LCEP. For the illustration, the maximum measured level that provided gunfire shock transition from 2000 rounds/minute to 4000 rounds/minute was selected based upon a visual inspection of the in-service test measured data. Figure 519.8A-1 provides an unprocessed time trace from a measured in-service digital recording. The time trace is from the same gun/materiel configuration, for the same event and in one of three mutually orthogonal axes termed the horizontal axis. The in-service measurement was made on a digital recorder with simultaneous channel record capability in the multiple axes with a sample rate of 102400 sps, and an anti-alias filter set at 8000 Hz. The time trace measurement bandwidth exceeds the bandwidth of the exciter system to be used for replication.

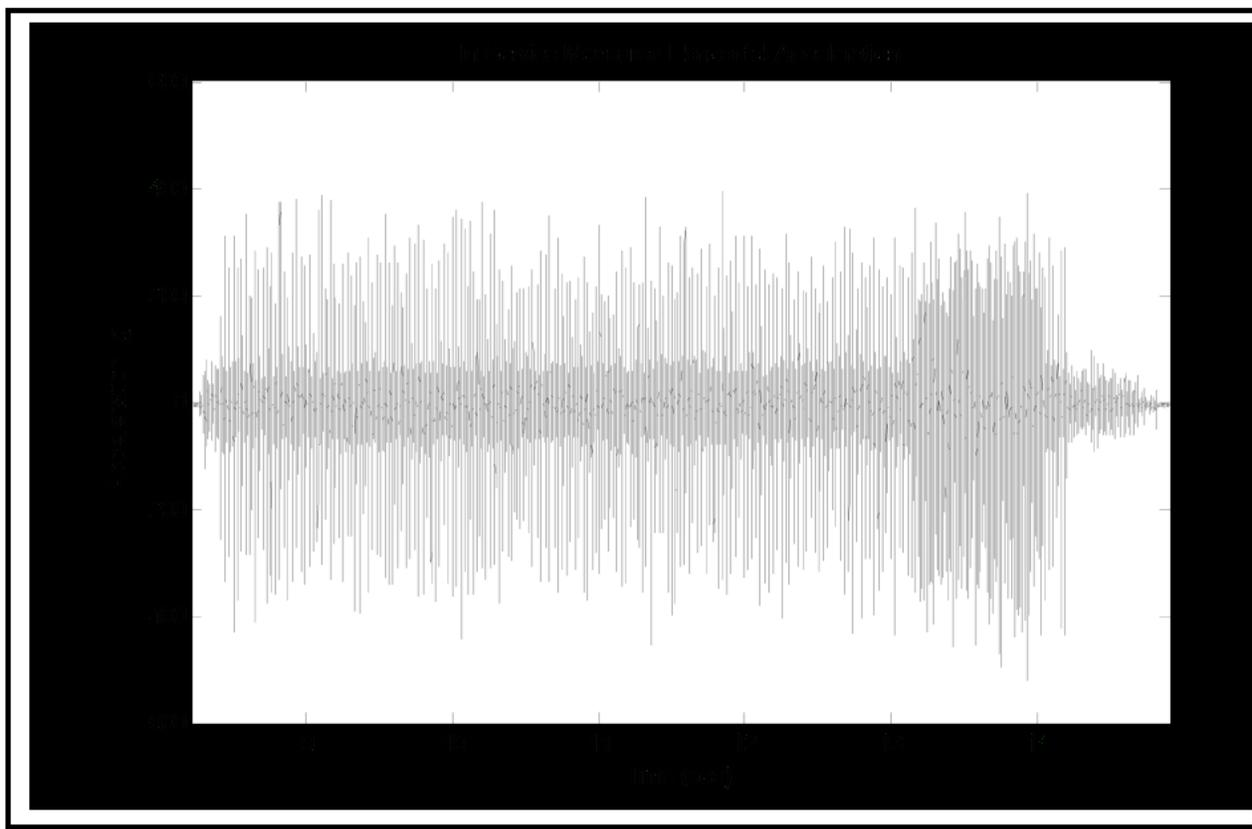


Figure 519.8A-1. In-service measured gunfire shock: unprocessed time trace (2000 round/min and 4000 round/min).

The **second step** in the measured environment replication process is to determine a laboratory test bandwidth, and to provide one or more specific digitized measured in-service time traces. The measured in-service time trace must be sampled (or interpolated from an adequate measurement bandwidth) at a minimum of ten times the highest frequency of interest for testing in order to best capture peak time trace information. The laboratory test bandwidth for the electrodynamic exciter is 10 Hz to 2000 Hz.

MIL-STD-810H
METHOD 519.8 ANNEX A**2.4 Replicating the Measured Gunfire Shock Materiel Input in Laboratory Test.**

Once the test strategy has been formulated and the measured time trace obtained digitally, as a **third step**, the band limited time trace is input to the vendor supplied TWR hardware/software that drives an electrodynamic exciter. Guidelines for performing the test are provided in Method 525.2 and will not be repeated here. As outlined in paragraph 4.2, if such testing is critical for materiel qualification, a dynamic simulant of the materiel may be used to compensate the exciter system for the input time trace. Once this compensation is complete, the dynamic simulant is replaced by the test item. Figure 519.8A-2 provides the reference, control, and difference time traces as a result of the testing to the band-limited reference time trace. Note that visual comparison of the reference and control time traces reveals the same character and the same general magnitude. The difference time trace computed by subtracting the reference time trace from the control time trace (see Method 525.2) reveal substantial peak and valley differences indicative of out-of-band energy within the control time trace as a result of impedance and boundary condition mismatch. For this illustrative test series, (1) a dynamic simulant was not used for reference time trace compensation, and (2) an optimum control strategy for additional compensation was not employed. Despite impedance and boundary condition mismatches, the general test error could have been reduced by employing a better compensation strategy.

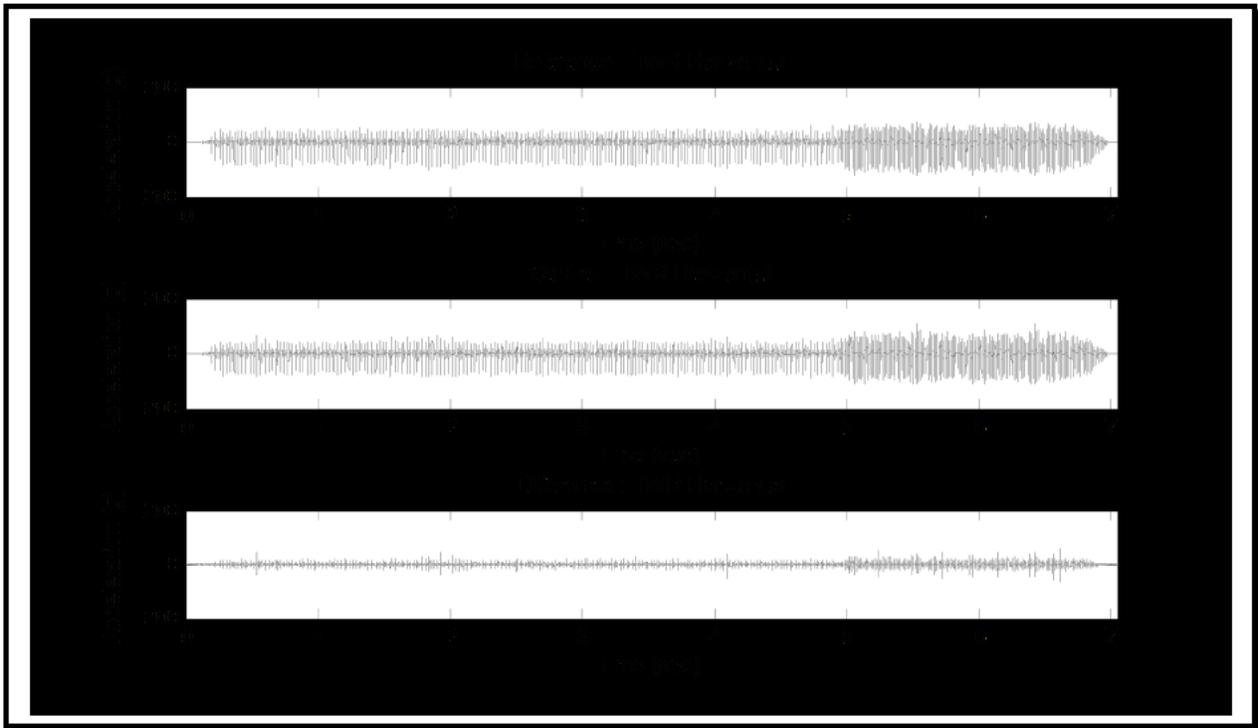


Figure 519.8A-2. Unprocessed TWR test reference, control, and difference time traces (10 Hz to 2000 Hz 25600 sps).

Figure 519.8A-2 represents all of the unprocessed time trace information available at the end of the test under the TWR test strategy, except for the compensated exciter drive time trace not displayed here.

MIL-STD-810H
METHOD 519.8 ANNEX A**2.5 Post-Test Processing.**

For illustrative purposes, the **fourth step** is post-test processing of the reference, control, and difference time traces to determine if test tolerances established beforehand have been satisfied. In certain test situations, the vendor supplied software estimates of "test replication error," along with visual time trace inspection, is sufficient for concluding that the test objectives have been met (and this relates to the philosophy behind TWR testing as described in Method 525.2). In other test situations, a detailed comparison of the reference time trace with the control/monitor time traces may be required to demonstrate compliance with test tolerances. In this latter case, to demonstrate test tolerance compliance, post-test processing independent of vendor software must be performed. For repetitive non-stationary form time traces from gunfire shock, a thorough post-processing assessment is performed best under pulse ensemble considerations. For this illustration, only the control time trace was processed for test tolerance satisfaction verification; monitor time traces were of no concern. Any monitor time traces of interest should be processed in the same manner as the control time trace (reference, control and monitor time traces must all be phase correlated as discussed in Method 525.2).

This Annex provides a summary of post-processing the time traces as a single entity but, depending upon the test tolerance formulation for test verification, either ensemble or single entity considerations may be used. Annex B will illustrate the more comprehensive ensemble approach to processing where stochastic simulation is the goal.

Initially, the reference and control time trace information from the TWR test is limited to the frequency band of interest. This bandpass filtering of the control time trace removes out-of-band energy. Figure 519.8A-3 displays the test control time trace before and after band-limiting between 10 Hz and 2000 Hz. The bottom plot is the measured control time trace. Note that the control time trace is reduced in amplitude. Band-limiting was performed using a third order Butterworth bandpass filter applied in the forward and backward directions for maintaining proper filter phase relationships.

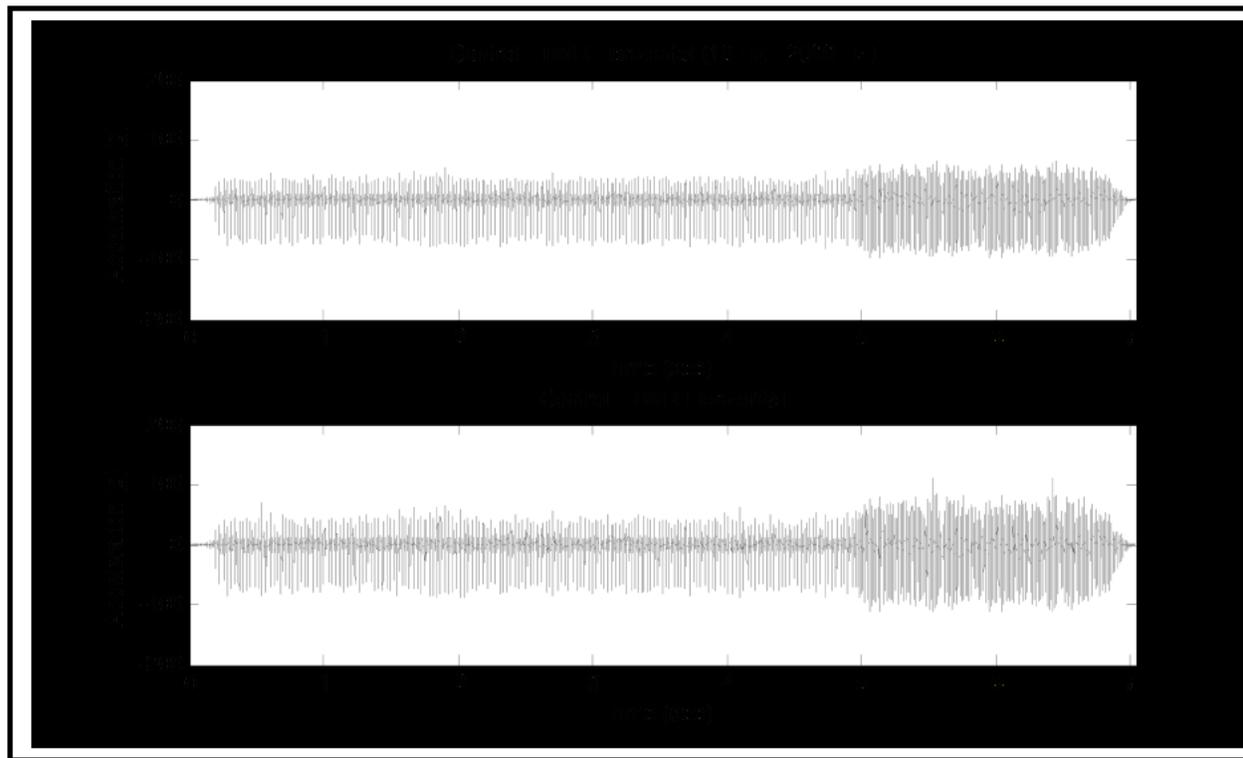


Figure 519.8A-3. Bandlimited (10 Hz to 2000 Hz) and unprocessed TWR test control time traces.

MIL-STD-810H
METHOD 519.8 ANNEX A

For the vendor software used in the TWR test, the phase relationship between the reference and control time traces is preserved (based upon a check of the cross-correlation function estimate between the control and reference time traces). Thus, one can proceed to compute the post-processed difference time trace by subtracting the reference time trace from the control time trace. Figure 519.8A-4 displays in high resolution six arbitrarily selected pulses for the reference, control and difference time traces for the 2000 round/minute gunfire rate. Figure 519.8A-5 provides the same information for the 4000 round/minute gunfire rate. In these two figures, even though the difference time trace scale is ten percent of the reference/control time scale, the difference time trace is generally not of a Gaussian form, and has generally large values correlated with peaks in the reference time trace.

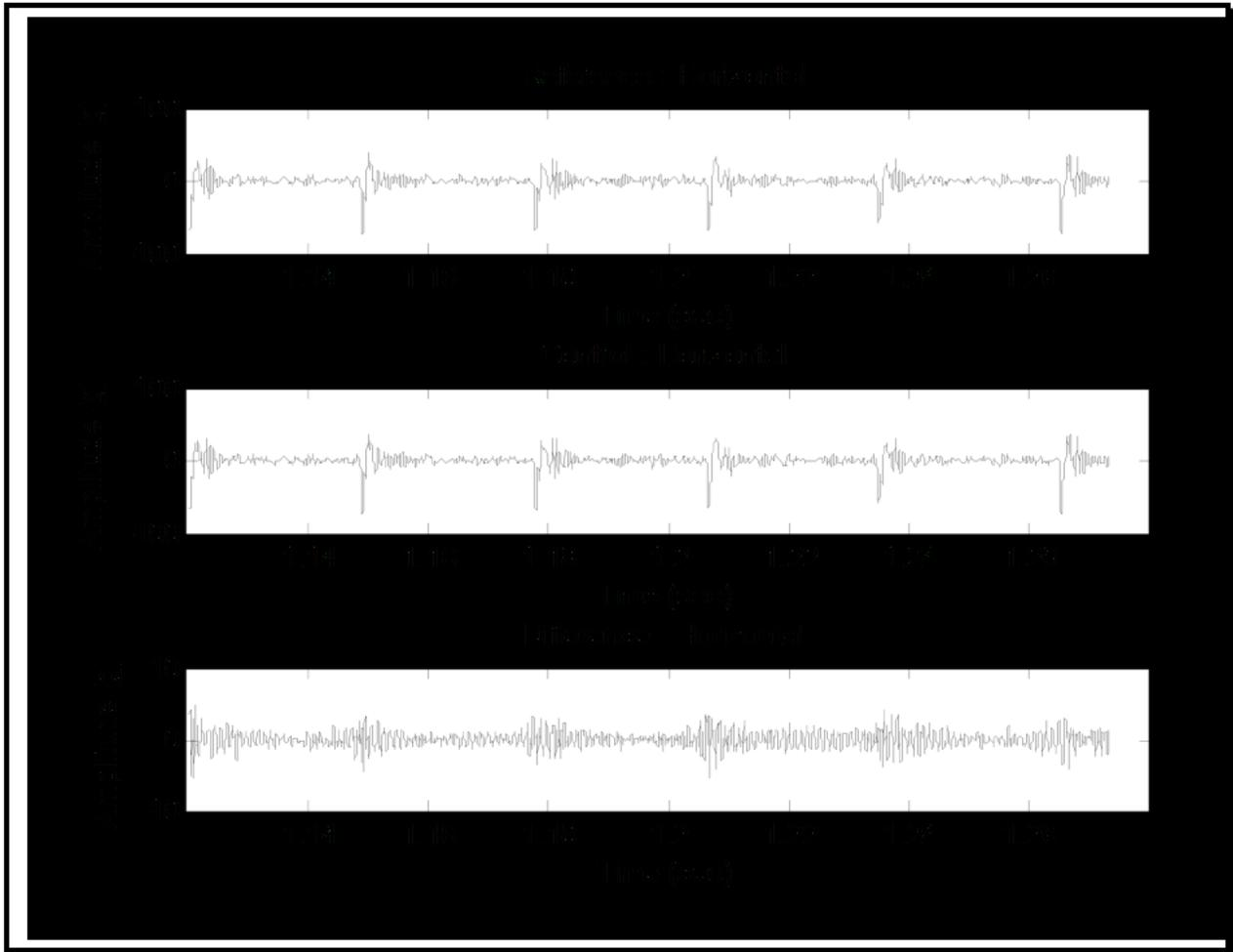


Figure 519.8A-4. High resolution representative members for the pulse ensembles (2000 rounds/minute).

MIL-STD-810H
METHOD 519.8 ANNEX A



Figure 519.8A-5. High resolution representative members for the pulse ensembles (4000 rounds/minute).

Method 525.2 provides basic guidance on test tolerance specification but, in general, Method 525.2 requires that test tolerance criteria be tailored according to the form of time trace that is being replicated. For the gunfire shock environment, test tolerances are most meaningfully established in the time domain for the entire time trace (for ensemble processing pulse ensemble time based statistics along with frequency domain ESD estimates for both gunfire rates would provide supplementary criteria).

For test tolerance assessment the following test tolerance criteria are established:

- a. Short-Time-Average-Root-Mean-Square (STARMS) of the *control time trace* and of the *reference time trace*, when differenced, be less in absolute value than 1.0 dB (approximately 12 percent) at 90 percent of the STARMS estimate points when the difference is referenced to the maximum STARMS for the reference time trace. The *short-time averaging time* is not to exceed 0.1 of the gunfire pulse period. In addition plot of the cross-correlation estimate between control and reference for STARMS, i.e., for rms levels, is to be within 0.90 at 90 percent of the STARMS estimate points. (This tolerance criterion relates to the rms estimate differences between the control and reference time traces - it tends to be quite broad.)
- b. STARMS applied to the *difference time trace* is to be less than -15 dB (approximately 1.8 percent) when referenced to the maximum STARMS reference time trace level at 90 percent of the STARMS estimate points. The *short-time averaging time* is not to exceed 0.1 of the gunfire pulse period. (This tolerance criterion in effect compares the “noise” as represented by the difference time trace to the “signal” as represented by maximum STARMS of the reference time trace.)

MIL-STD-810H
METHOD 519.8 ANNEX A

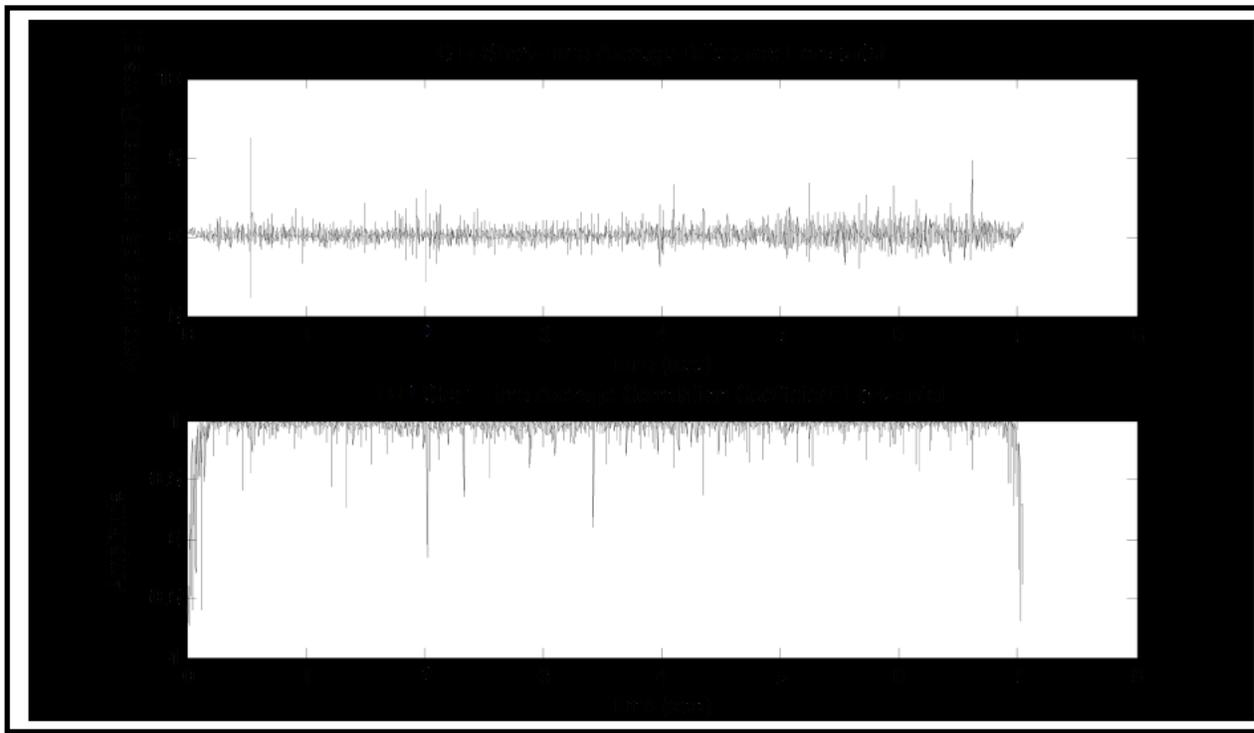
- c. Ideally the *difference time trace* amplitudes are Gaussian distributed. Usually this is never the case. It is required that qq-plot magnitudes beyond Gaussian three-sigma positive and negative limits not exceed the following:

For positive (negative) long tail distribution greater than 1.0 dB (approximately +12 percent) when referenced to the maximum absolute reference time trace positive (negative) peak, and;

For positive (negative) short tail distribution less than - 1.0 dB (approximately - 11 percent) when referenced to the maximum absolute reference time trace positive (negative) peak.

These test tolerance criteria are designed to compare reference and control time traces based upon their perfect correlation in time. If there exists a phase difference between the time traces, then none of the above test tolerance criteria are valid. If these test tolerance criteria can be satisfied, the test performance will be established.

Figure 519.8A-6 displays STARMS level difference between control and reference time traces where the short-time averaging time was selected to be $0.1 * 60 / 4000 = 0.0015$ seconds over the entire time trace, and the maximum reference rms level was 100 g-rms. For each of the short-time-average rms estimates, the cross-correlation estimate between reference and control was computed and displayed.



**Figure 519.8A-6. STARMS difference between control and reference with cross-correlation estimate.
(Difference: ref = 45.1 g-rms /cross-correlation)**

Figure 519.8A-7 displays STARMS for the difference time trace, where the short-time averaging time was selected to be $0.1 * 60 / 4000 = 0.0015$ seconds over the entire time trace, and the maximum reference rms level was 45.1 g-rms.

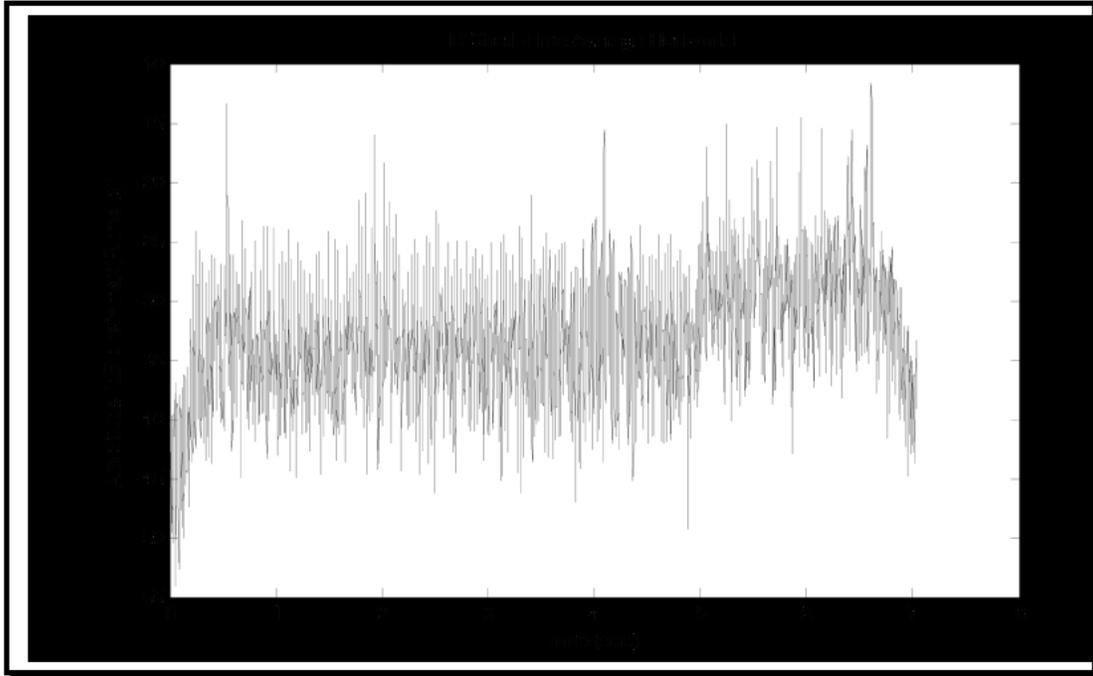
MIL-STD-810H
METHOD 519.8 ANNEX A

Figure 519.8A-7. STARMS for difference time trace.(Difference: ref = 45.1 g-rms)

The qq-plot for the difference time trace is displayed in Figure 519.8A-8, along with the three-sigma Gaussian limits. It is clear that the difference time trace is not Gaussian distributed, but has a long tail structure. This appears to be characteristic of most all TWR tests, and somewhat complicates tolerance specification. But for reference peak amplitudes on the order of 100g in the negative and positive directions, generally the maximum differences are within 1dB of the peak reference magnitudes.

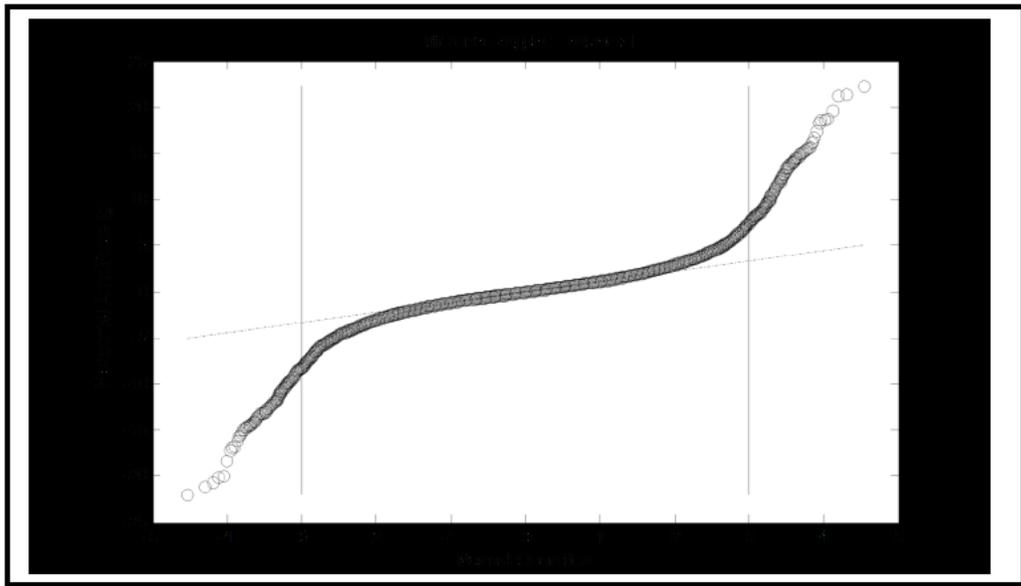


Figure 519.8A-8. qq-plot for Gaussian versus difference time trace.

Figure 519.8A-9 displays cross-plot information for reference versus control time traces. It is unclear how this information can be used for establishing test tolerance. Simple confidence intervals around a straight line fit of the cross plot points is difficult to interpret, and is contrary to intuition. Typically such confidence intervals as a result of

MIL-STD-810H
METHOD 519.8 ANNEX A

straight-line regression fits are a minimum distance apart for values near zero, and a maximum distance apart near the end points or peaks. For TWR testing, the larger differences or errors tend to be for values near zero where noise has a greater effect on the “signal” defined by the reference time trace.

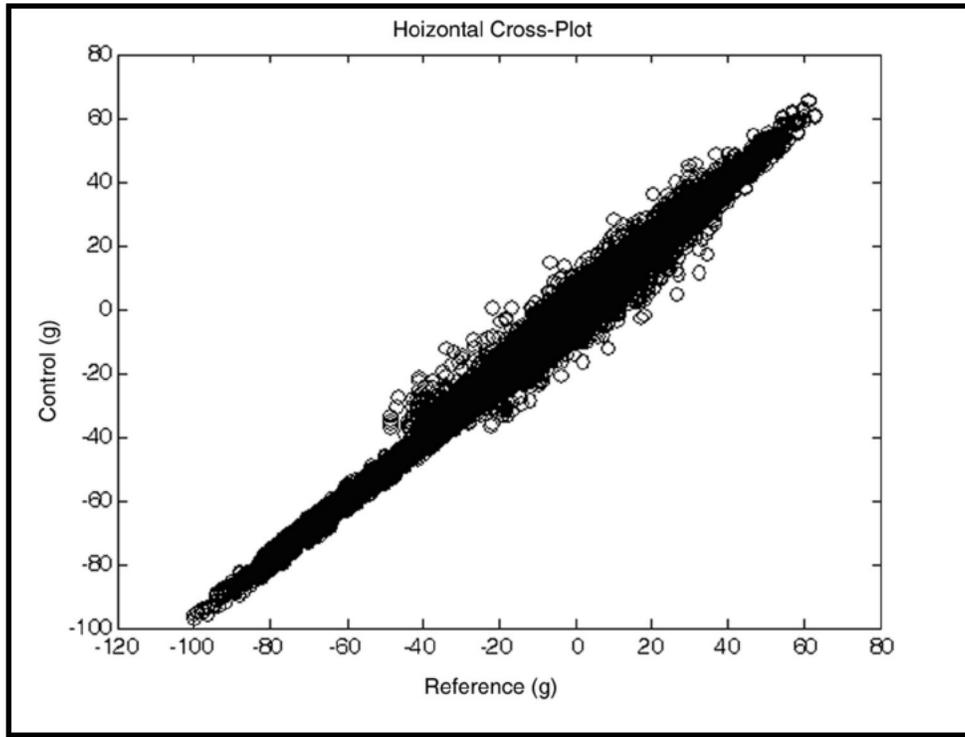


Figure 519.8A-9. Reference versus control cross-plot.

Figure 519.8A-10 provides some initial information on the relationship between the reference and control peak structure. Detailed modeling of peak structure could be performed here, however, two basic considerations must be examined. First, an assumption that peak information is vital to the integrity of the test material must be established (peak time trace information is generally only loosely correlated with test material integrity - the pseudo-velocity shock response spectrum represents material stress better). Second, a decision must be made as to if the unprocessed (non-band limited) control time trace, or the processed (band limited) control time trace is to be compared with the reference time trace relative to peak information. Peak modeling and subsequent interpretation must consider both assumption and decision. In this Annex, a simple time trace plot along with a normal qq-plot is provided for the difference between a reference time trace peak (or valley), and the corresponding control time trace value (that may not represent a peak or valley response). Reference and control time traces have a common bandwidth. Statistics of this somewhat “stationary” appearing serial set of random variables (not a uniformly sampled time trace) are also provided in Table 519.8A-1.

MIL-STD-810H
METHOD 519.8 ANNEX A

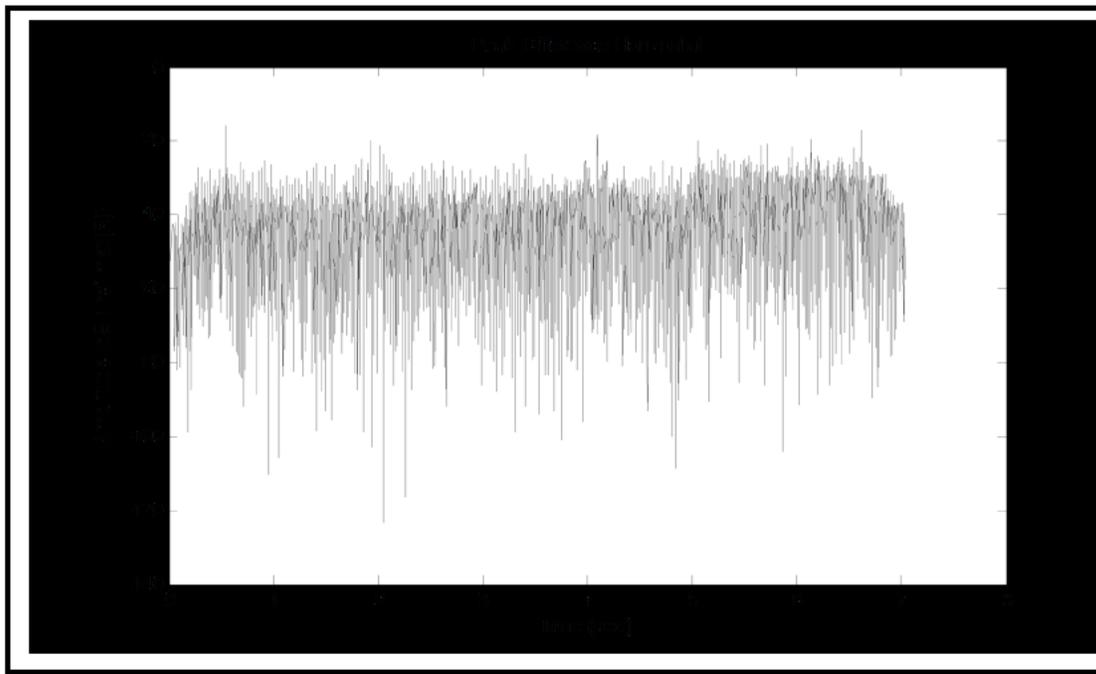


Figure 519.8A-10a. Peak statistic difference.

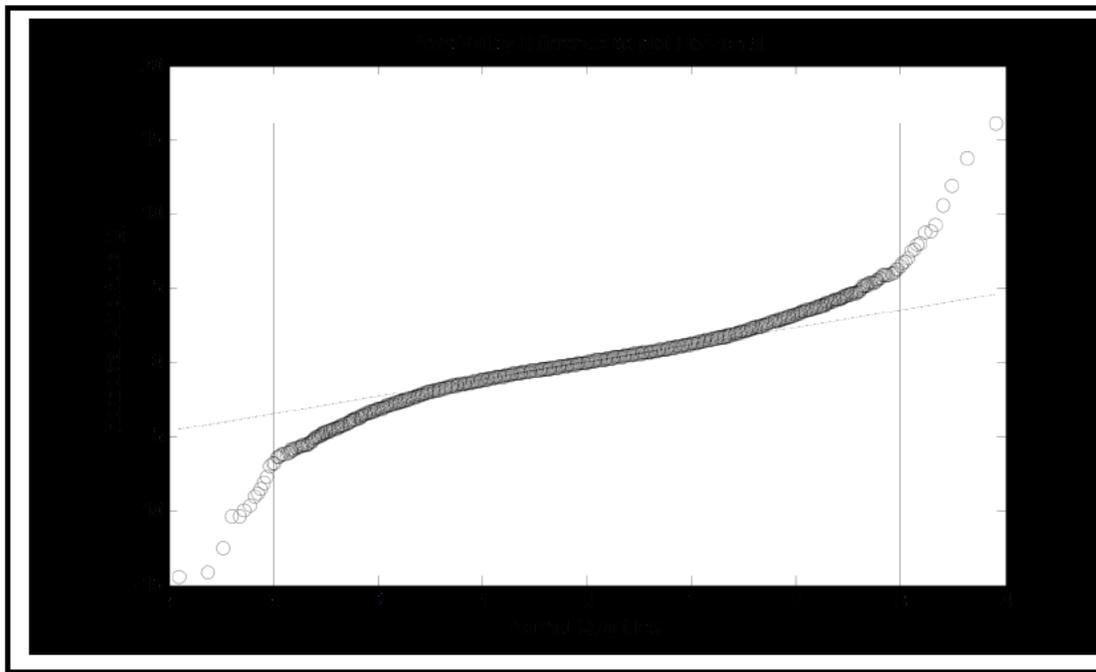


Figure 519.8A-10b. Peak/valley statistic difference - qq-plot.

MIL-STD-810H
METHOD 519.8 ANNEX A

The minimum, maximum, mean, standard deviation, skewness, and kurtosis of the peak statistic difference serial time sample is provided in the Table 519.8A-I.

Table 519.8A-I. Peak statistic difference statistics.

Minimum peak difference	-14.48
Maximum peak difference	16.14
Mean peak difference	0.07
Root-Mean-Square peak difference	1.53
Skewness for peak difference	-0.06
Kurtosis for peak difference	10.17

2.6 Conclusion.

2.6.1 General Remarks.

Procedure I defines a test rationale that provides substantial confidence in the materiel integrity under gunfire shock. In fact, for single point materiel response measurements on comparatively simple dynamic materiel, the method of direct replication of in-service measured materiel response is tailoring sensitive and near “optimal.” The main disadvantage of Procedure I is that there is no obvious way to statistically manipulate (basically “scale-up”) the measured materiel input/response data to ensure a “conservative test.” As discussed in Method 525.2, the “optimal” assumption regarding a single field measured time trace is that it represents the mean time trace or 0.5 confidence coefficient from the underlying random process it represents, i.e., if an ensemble of realizations of the underlying random process is available, the available single field measured time trace is a valid estimate of the mean of the underlying random process, or under a probabilistic framework, a single unique measured time trace must be assumed to representative of the mean of the underlying random process, assuming an infinite collection of such time traces could be collected under identical circumstances.

Procedure I is optimum when more than one measured gunfire shock environment is available, and the gunfire shock environments are concatenated into a sequence representative of the LCEP in-service conditions.

2.6.2 Stochastic Generation.

In cases in which multiple gunfire replications are required from limited measurement information there exist approaches to generating stochastic time history traces. Smallwood (reference h) and Merritt (reference g) both propose pulse ensemble approaches to replication of gunfire time traces based upon measured information. Both of these procedures, Smallwood in the frequency domain and Merritt in the time domain, required that the measurement information be provided in the form of an ensemble of pulses with “correlated” time history information i.e., the ensemble of pulses were precisely “lined up” in time based upon time history correlation procedures. Both of these procedures described in detail in the references provided reliable methods for providing a stochastic generation of gunfire time trace records for laboratory testing. With the advent of “wavelet” procedures, that are localized in time, manipulation of either pulse ensemble detail wavelet coefficients or the entire measurement gunfire time trace information at some level of “wavelet detail” can be used to stochastically (as a result of wavelet coefficient manipulation) employed to generate a new gunfire shock realization that is as “close” to the measurement as desired. Wavelet coefficient manipulation because of the wavelet localization properties can be used to artificially scale measurement information to produce more conservative test scenarios. No guidelines can be provided here for implementation of wavelet based stochastic generation of time history traces, however, any stochastic manipulation and time trace reproduction under TWR must be consistent with the test tolerances provided in Methods 525.2 or 527.2.

MIL-STD-810H
METHOD 519.8 ANNEX A

(This page is intentionally blank.)

MIL-STD-810H
METHOD 519.8 ANNEX B**METHOD 519.8, ANNEX B****GUIDELINES FOR PROCEDURE II - SRS GENERATED SHOCK TIME HISTORY PULSE SEQUENCE UNDER TWR****1. SCOPE.****1.1 Purpose.**

The purpose of Procedure II is to provide an alternative gunfire shock testing philosophy when only an SRS computed from a gunfire event is provided. In cases in which a measurement time history is available Procedure I must be used without exception. An estimate of the available time history SRS cannot be used to provide an alternative gunfire test to Procedure I, utilizing Procedure II. To implement this procedure the following three pieces of information are required:

1. An SRS (termed a "Target SRS") and associated damping as computed over a specified natural frequency bandwidth. (This SRS may be from a measurement previously processed from time history data that is no longer available or from an SRS that is of a generic nature).
2. The fundamental firing rate of the gun.
3. The duration of the "gunfire event" indicating the number of pulses to be concatenated for the proposed TWR testing (as defined per the LCEP).

As is likely to be the case, the SRS display, i.e., natural frequency versus maximax SRS estimate, may extend beyond the test frequency bandwidth for the TWR implementation. This is particularly true for low natural frequency display and very high natural frequency display. For low natural frequency display, this may be the result of processing a gunfire time history or defining a generic reference extending much beyond the period of the firing rate. For high natural frequency display this may be a result of gunfire response extending well beyond electrodynamic exciter capabilities.

Procedure II requires input from Method 516.8 relative to (1) proper synthesis of deterministic time histories from SRS estimates with representative shock duration, and (2) laboratory test SRS tolerance limits. In addition, since the testing will be implemented under TWR, TWR testing options from Method 525.2 may also be applicable. From Method 516.8 the SRS "sine-beat procedure" or "damped sine procedure" provide an algorithmic methodology for generating a single deterministic pulse time history from the SRS estimate. Typically, this generated pulse matching the SRS will extend well beyond the period related to the gun firing rate.

An SRS estimate provided for a single pulse from a gunfire shock event is unacceptable for gunfire shock testing and any such proposed testing relative to single pulses must follow the philosophy and guidelines of Method 516.8.

This Annex assumes that the testing facility is fully qualified to provide a deterministic pulse based upon SRS considerations as outlined in Method 516.8, synthesizing the pulse train and providing additional manipulation in order to perform the Single-Exciter/Single-Axis (SESA) TWR Procedure in Method 525.2 with the analytically generated reference time history.

1.2 Application.

This Annex addresses a method for laboratory gunfire shock replication under TWR based upon SRS specification alone. This application begins with a single deterministic shock pulse generated based upon the SRS "sine-beat" or "damped sine" vendor procedure which is then concatenated to the duration of the specified "gunfire event". In general an SRS determined over the deterministic concatenated pulse train will not be within tolerance as specified for shock in Method 516.8 for the lower natural frequencies. There are a variety of means of bringing the concatenated pulse train within tolerance. One such procedure is to generate a bandlimited random time history, scaling to a correct amplitude based upon SRS estimate considerations and then adding the bandlimited random time history to the concatenated deterministic pulse train file. This results in a form of impulsive shock random time history. The resulting time history should provide an SRS estimate within SRS tolerance called out in Method 516.8 for standard shock. It is noted that the advantage accrued via the SRS procedure is that SRS based laboratory test tolerances are readily available and easily understood (see Method 516.8). However, in TWR execution of the test, time history test tolerances under TWR, Method 525.2, must be observed. That is both the SRS tolerances for overall test satisfaction according to the specification and TWR test tolerances for execution of the test are applicable, with SRS test tolerances of first concern for specification satisfaction. The major limitation of the procedure is that SRS information at

MIL-STD-810H
METHOD 519.8 ANNEX B

frequencies below the gunfire rate based upon the proposed test length (in terms of number of pulses at the gunfiring rate) can only be accounted for in an ad hoc manner.

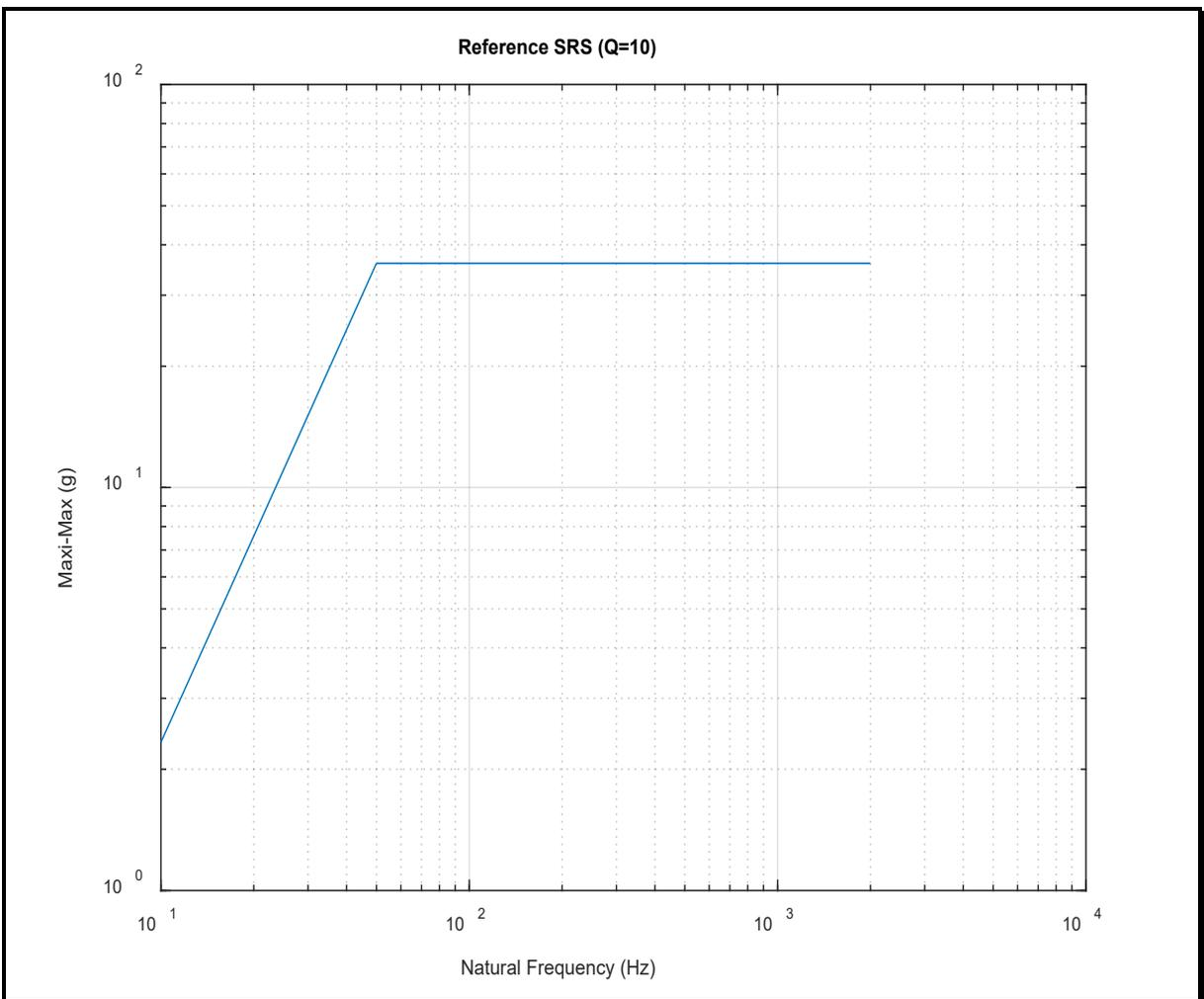
2. BASIC CONSIDERATIONS FOR GENERATION OF A DETERMINISTIC GUNFIRE SHOCK TIME HISTORY FROM A SRS ESTIMATE.

2.1 Introduction.

It is assumed that an SRS over a given natural frequency bandwidth is available for description of the gunfire shock event assumed to be a product of a form of replicated shock and TWR is the prescribed method of test. It is assumed that the natural frequency bandwidth is compatible with the laboratory test apparatus i.e., electrodynamic or electrohydraulic exciter. Procedure II will be illustrated for a generic SRS gunfire shock specification.

2.2 Single Gunfire Shock Event with SRS Specification.

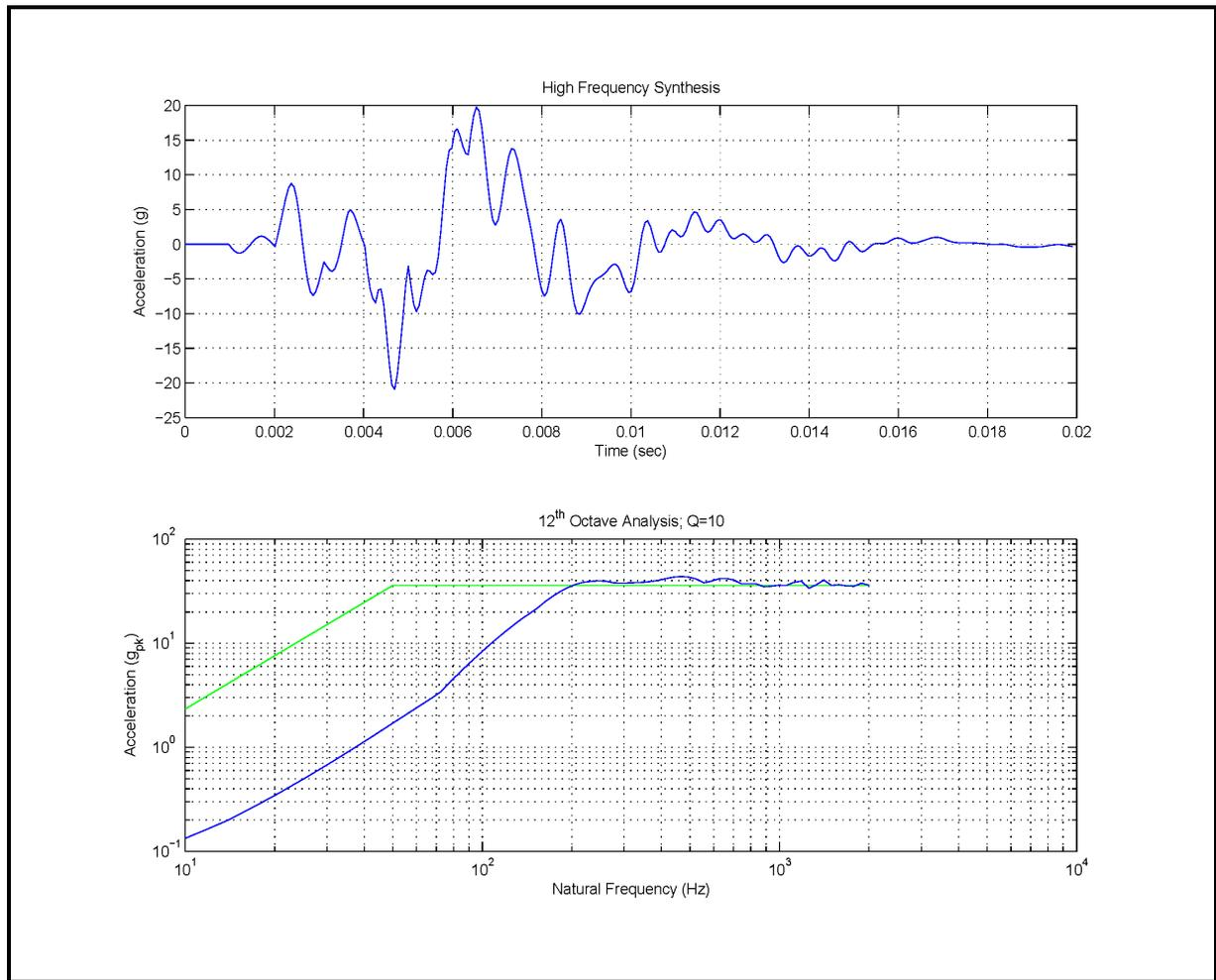
Figure 519.8B-1 illustrates a generic maximax SRS representing a “gunfire event” with “event” implying “replicated shock” at the gunfire rate. The SRS is termed the “Target SRS” implying that this SRS must be satisfied in the testing procedure within tolerances provided in Method 516.8. The gunfire rate is specified as 50 Hz providing a fundamental pulse repetition at 20 millisecond time intervals. The natural frequency bandwidth is from 10 to 2000 Hz. All SRS computations in the example were computed with a one-twelfth octave resolution and $Q=10$. For this example, assume the gunfire schedule calls for firing 10 bursts of 1 second duration i.e., 50 pulses and a gunfire schedule separation of 2 seconds between bursts. For this specification the natural frequency bandwidth is compatible with the bandwidth of the electrodynamic exciter for Method 525.2 TWR testing.



MIL-STD-810H
METHOD 519.8 ANNEX B

Figure 519.8B-1. Generic example gunfire SRS reference.

Figure 519.8B-2 displays a single deterministic pulse that has been generated from the Method 516.8 SRS algorithm implemented via the “sine-beat” procedure over 0.02 seconds (the period of the gunfire). Due to the short duration associated with the period of an individual frequency component, the low frequency limit in the synthesis is recommended to be one to two octaves above the gunfire frequency. This will allow inclusion of a reasonable number of cycles of the lower frequency components in the synthesis process. The resulting synthesis illustrated in Figure 519.8-B-2 was based on the reference SRS of Figure 519.8B-1 between 200 and 2000 Hz. It is noted that valid SRS information existing below the low frequency limit (200 Hz in this example) has been suppressed in the analytically generated pulse. The low SRS natural frequencies are artifacts of the variations between individual pulses in the original multiple shot measured time history. The low frequency information will be synthesized in a subsequent step.



**Figure 519.8B-2. Deterministic SRS sine-beat synthesized pulse
(extended over 20 milliseconds for 50 Hz gunfiring rate).**

Figure 519.8B-3 displays the concatenated pulse to the specified duration (1 second bursts for this example). This concatenated pulse representing the “gunfire event” provides an SRS estimate as compared to the specified SRS. The prescribed duration of the concatenation will artificially introduce some low natural frequency SRS information but usually not enough information such that the SRS tolerance in Method 516.8 will be met. Guidance on addressing the low frequency portion of the SRS follows.

MIL-STD-810H
METHOD 519.8 ANNEX B

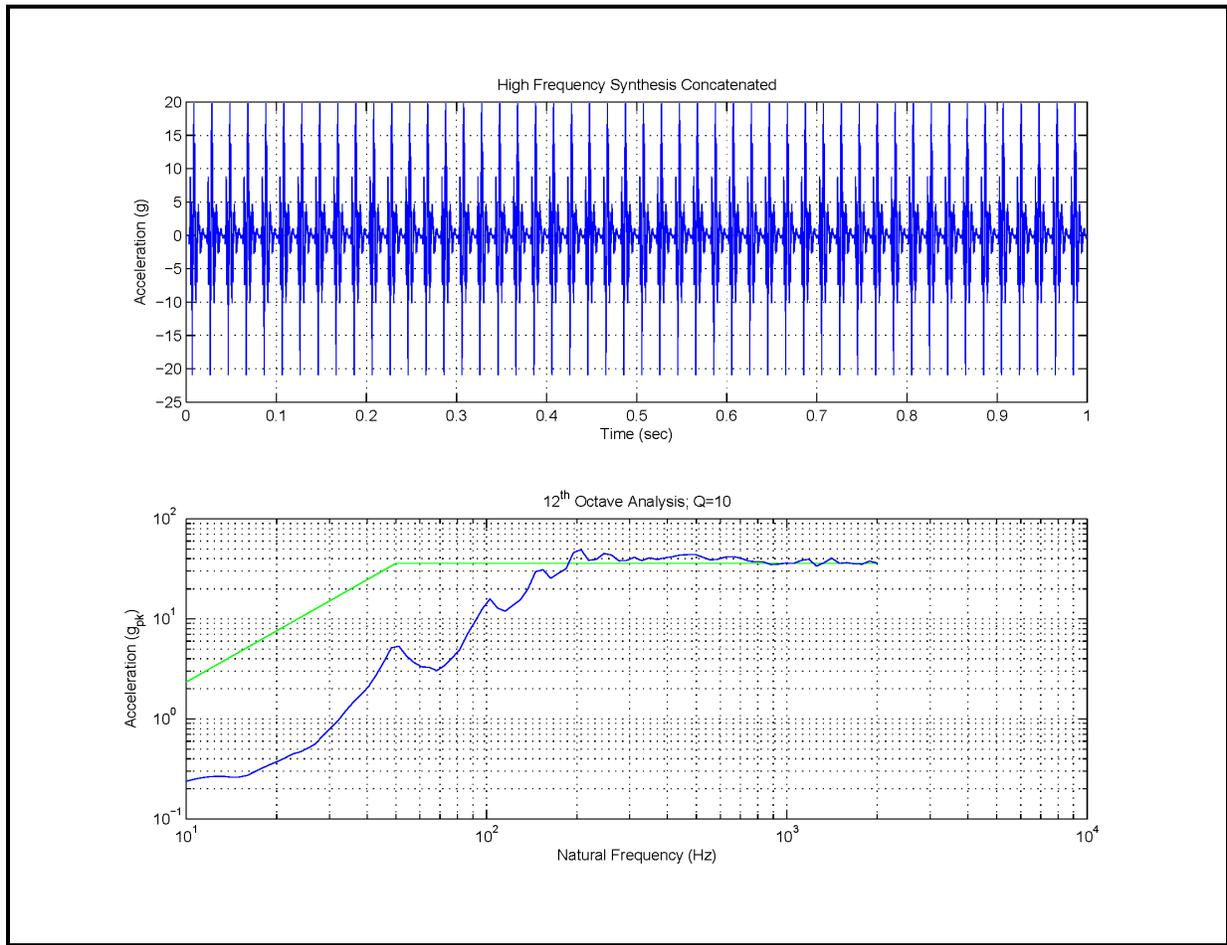


Figure 519.8B-3. Concatenated high-frequency synthesis (200 -2000 Hz)

From the SRS plot in Figure 519.8B-3 it is clear that additional manipulation needs to take place to meet the low natural frequency SRS tolerance levels. There exist several ways in which the SRS information in the low natural frequencies can be enhanced. A suggested method is to employ a time history “Additive Model” by adding a properly scaled bandlimited random time history of duration of the “gunfire event to the concatenated time history displayed in Figure 519.8B-3. Figure 519.8B-4 displays such a random time history bandlimited between 10 Hz and just under 200 Hz over a one second time interval that meets the SRS characteristics of the reference SRS. The low frequency synthesis is recommended to have a maximum frequency content that falls one or two bins below the minimum frequency of the high frequency synthesis to avoid excessive overlap associated with the twelfth octave filter banks.

MIL-STD-810H
METHOD 519.8 ANNEX B

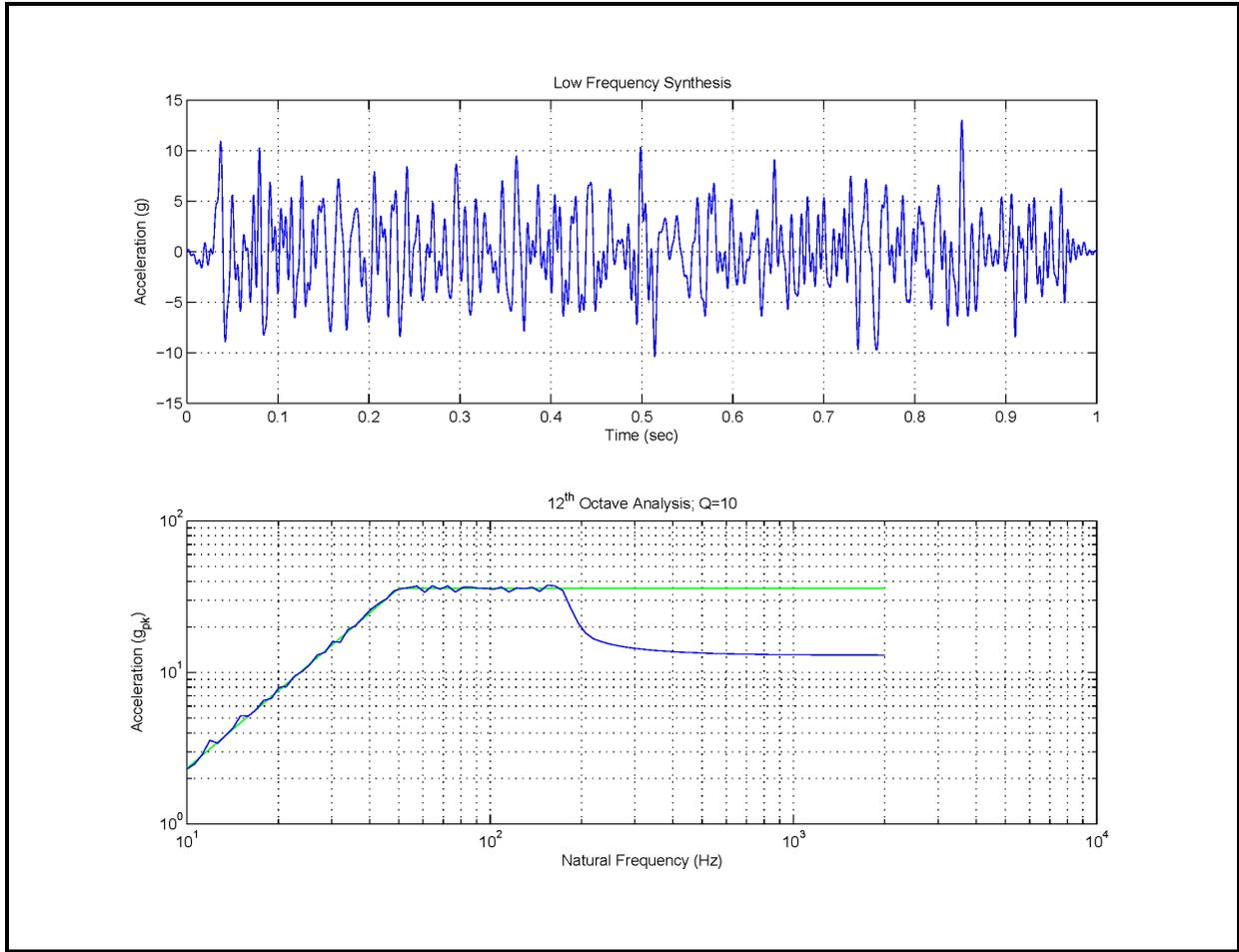


Figure 519.8B-4. Bandlimited random synthesis (10 Hz – 200 Hz).

Figure 519.8B-5 displays the effects of the low frequency synthesis of Figure 519.8B-4 added to the concatenated pulse in Figure 519.8B-3. The resulting time history provided in Figure 519.8B-5 is a first iteration of a possible reference to be used for the TWR testing. The lower plot in Figure 519.8B-5 displays the difference between the SRS specification and the SRS for the analytical generation to be executed under TWR as described in Method 525.2. Slight iterations on the high frequency synthesis are possible if it is determined that the original iteration is not sufficiently close to the desired reference.

Once an acceptable one second reference time history has been established, it is just a matter of programming the TWR software to repeat the one second record ten times with two seconds between each event as specified per the LCEP in the introductory paragraph of this example.

It should also be clear that the manipulation involved in this process requires that of a trained analyst. Once a reference time history has been synthesized and accepted by the appropriate test authority, the resulting time history may be used as a common reference in the event multiple laboratories are involved in conduct of a common test.

MIL-STD-810H
METHOD 519.8 ANNEX B

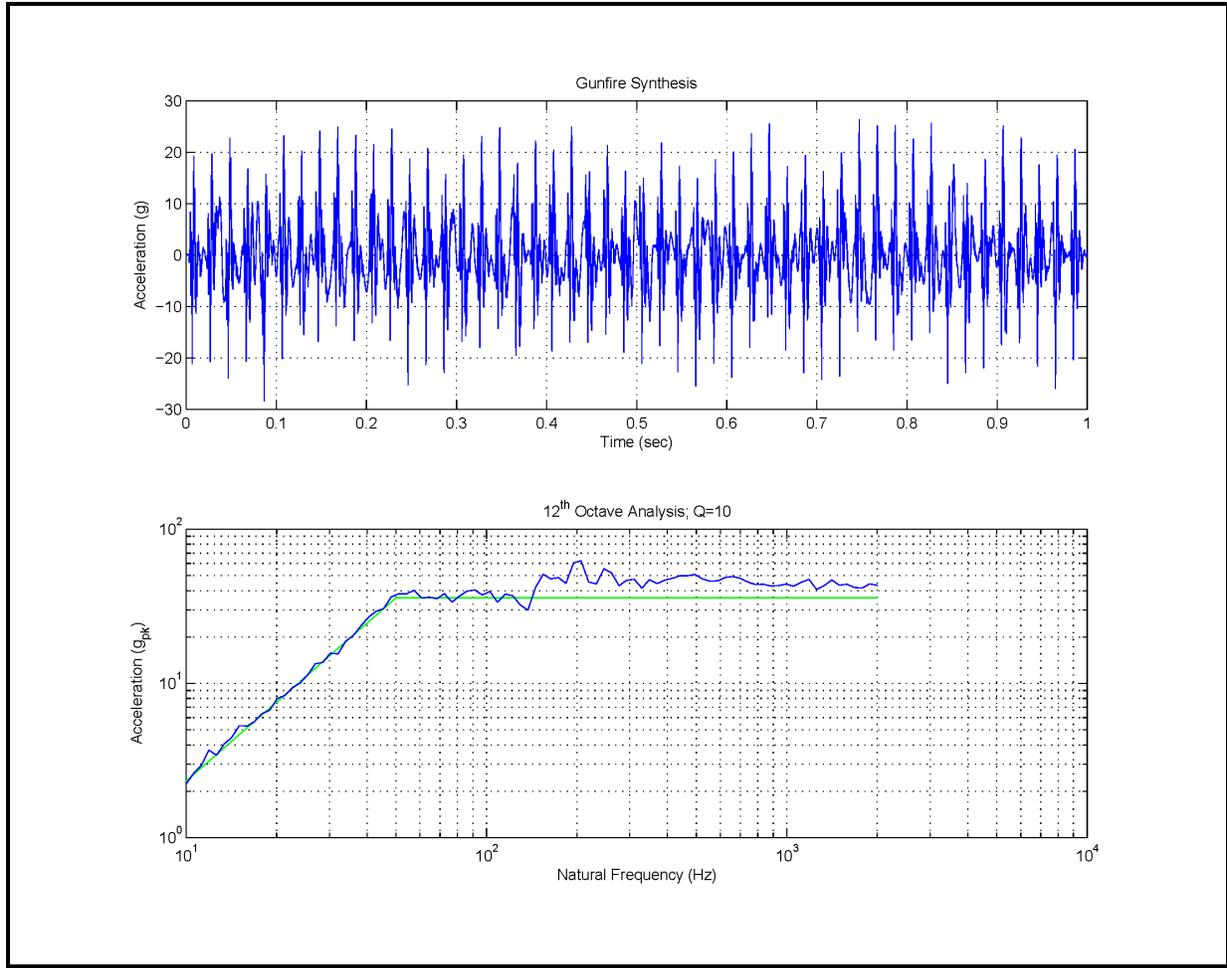


Figure 519.8B-5. Synthesized one-second gunfire shock pulse train reference per additive model.

2.3 Multiple Gunfire Shock Events with SRS Considerations.

When multiple gunfire shock events for SRS estimates are provided then laboratory testing may proceed as in paragraph 2.2 for a single gunfire shock event applied by each of the multiple gunfire shock events.

One acceptable means of providing a form of stochastic implementation of the SRS procedure is to create deterministic SRS sine-beat based pulse time histories based upon SRS estimates for independent gunfire event time histories. That is, for each gunfire event a series of “sine-beat pulses” is generated and concatenated into one overall pulse time history. The statistical variation in the individual gunfire events can be represented by this procedure. This procedure can also be used to produce a very large number of unique and statistically independent overall gunfire time history events by Monte-Carlo sampling of the SRS sine beat generation.

3. CONCLUSION.

It is generally unusual to have an SRS estimate for a gunfire event without the accompanying measurement time history, however, if this is the case Procedure II must be applied. In all cases where measurement time history trace information is available Procedure I must be applied. When an ensemble of SRS estimates are available from multiple independent gunfiring events a certain degree of statistical processing may be introduced via enveloping of the set of SRS estimates or even in detail modeling each SRS with an SRS beat generation form of deterministic time history.

MIL-STD-810H
METHOD 519.8 ANNEX C

METHOD 519.8, ANNEX C

GUIDELINES FOR PROCEDURE III - STOCHASTICALLY GENERATED MATERIEL INPUT FROM PRELIMINARY DESIGN SPECTRUM

1. SCOPE.

This Annex provides the option of using predicted gunfire vibration in the form of a Sine-on-Random (SOR) spectrum when measured data are not available. Information in this Annex is to ensure materiel mounted in an aircraft with onboard guns can withstand the predicted environmental acceleration levels caused by (1) pulse overpressures emitting from the muzzle of the gun impinging upon materiel support structure, and (2) structure-borne vibration. The first portion of this Annex constitutes a reformatting of Method 519.5, Gunfire Vibration, Aircraft, in MIL-STD-810F with a limited number of enhancements. The second portion of this Annex briefly describes two methodologies for taking a predicted spectrum and generating a form of "shock pulse" acceleration time history of arbitrary length whose ASD estimate matches the predicted spectrum and can be implemented using Method 525.2 Time Waveform Replication (TWR). The two methodologies represent time domain and frequency domain implementations of standard Fourier based techniques.

Note that the predicted spectrum has a continuous part and a discrete part consisting of a fundamental frequency/amplitude and three additional components with frequencies at harmonic ratios to the fundamental. The SOR is a more limited and specific terminology and implies vibration controller implementation.

MIL-STD-810H
METHOD 519.8 ANNEX C**PART 1 - SPECTRUM PREDICTION METHODOLOGY
FOR PRELIMINARY MATERIEL DESIGN****1. SCOPE****1.1 Purpose.**

This Annex provides the option of using predicted gunfire vibration (Sine-on-Random [SOR]) data (when measured data are not available), to ensure materiel mounted in an aircraft with onboard guns can withstand the predicted environmental acceleration levels caused by (1) pulse overpressures emitting from the muzzle of the gun impinging upon materiel support structure, and (2) structure-borne vibration. (This Annex constitutes a reformatting of Method 519.5, Gunfire Vibration, Aircraft, in MIL-STD-810F with a limited number of enhancements.) This Annex also provides the option for using high level random vibration (measured data are available) when the measured data spectrum displays no outstanding discrete harmonic components.

1.2 Application.

This Annex is applicable only for aircraft gunfire and materiel mounted in an aircraft with onboard guns. Guidance in this Annex is to be used only if in-service measured materiel response data are not available, or will not be available in the early stages of a development program. This Annex is not intended to justify the use of SOR or narrowband random-on-random for cases in which measured data display a broadband spectra along with components at discrete frequencies. Use the information in this Annex only if it is vital to the design of the materiel. If there is a possibility of obtaining early measurements of the materiel response mounted on the in-service platform, supplant the severities developed using the information in this Annex with the severities estimated from the materiel response under in-service measurements, and one of the other procedures used for testing. In particular, if the measured materiel response in-service environment has the character of high level broadband random vibration with no characteristics conducive to application of Procedure II or Procedure III, then:

- a. Apply Procedure I in the form of transient vibration, or
- b. Submit the test item to a specified level of high level broadband random vibration (based on ASD estimates of the measured in-service materiel response) over a period of time, consistent with low cycle fatigue assumptions in accelerated testing or as specified in the test plan (see Method 514.8).

This technique is based upon obtaining the predicted SOR spectrum, using the four sine components in phase to develop the envelope of the form of a pulse, and using the predicted spectrum as stationary random vibration that can be enveloped to provide a pulse form time trace that can be used for preliminary design of materiel where no additional information is available. This technique is not intended to develop a pulse that can be concatenated and used for testing under TWR.

1.3 Limitations.

This Annex is not intended to justify the use of SOR or narrowband random-on-random for cases in which measured data displays a broadband spectra along with components at discrete frequencies.

2. DEVELOPMENT.**2.1 Introduction.**

This Annex is essentially a reorganized reproduction of the information contained in reference g. of paragraph 6.1, with some additional guidance. Mention of the pulse method in paragraph 6.2, reference f, is included, and provides insight into the use of the pulse method in conjunction with a predictive rationale. Procedure III differs from the other two procedures in that it is a result of a prediction procedure developed on the basis of an analysis of a comparatively small set of measured gunfire materiel response data. The predicted spectrum, therefore, provides estimates of materiel vibration response that may be substantially different from in-service measured vibration response of a particular materiel. For a particular materiel and gun/materiel configuration, materiel response to gunfire is generally not amenable to accurate prediction. The prediction methodology provided below is generally subject to a large degree of uncertainty with respect to test level. This uncertainty is very apparent in gunfire configurations where the gun is less than a meter (3.3 ft) from the materiel.

MIL-STD-810H
METHOD 519.8 ANNEX C

2.2 Predicting Gunfire Vibration Spectra.

Gunfire vibration prediction spectra consist of a broadband spectrum representative of an ASD estimate from stationary random vibration, along with four harmonically related sine waves. Figure 519.8C-1 provides a generalized vibration spectrum for gunfire-induced vibration that defines the predicted response of materiel to a gunfire environment. It is characterized by four single frequency harmonically related (sine) vibration peaks superimposed on a broadband random vibration spectrum. The vibration peaks are at frequencies that correspond to the nominal gunfire rate and the first three harmonics of the gun firing rate. The specific values for each of the parameters shown on Figure 519.8C-1 can be determined from Table 519.8C-I, Table 519.8C-II, Table 519.8C-III, and Figures 519.8C-2 through -8. The suggested generalized parametric equation for the three levels of broadband random vibration, T_j , defining the spectrum on Figure 519.8C-1, is given in dB for g^2/Hz (reference to 1 g^2/Hz) as:

$$10\log_{10}(T_j) = 10\log_{10}(N F_1 E) + H + M + W + J + B_j - 53 \text{ dB} \quad j=1, 2, 3 \quad \text{Equation (C-1)}$$

where the parameters are defined in Table 519.8C-I. The suggested generalized parametric equation for the four levels of single frequency (sine) vibration defining the spectrum on Figure 519.8C-1 is given in dB for g^2/Hz (reference to 1 g^2/Hz) as

$$10\log_{10}(P_i) = 10\log_{10}(T_3) + K_i + 17 \text{ dB} \quad i=1, 2, 3, 4 \quad \text{Equation (C-2)}$$

where the parameters are defined in Table 519.8C-I.

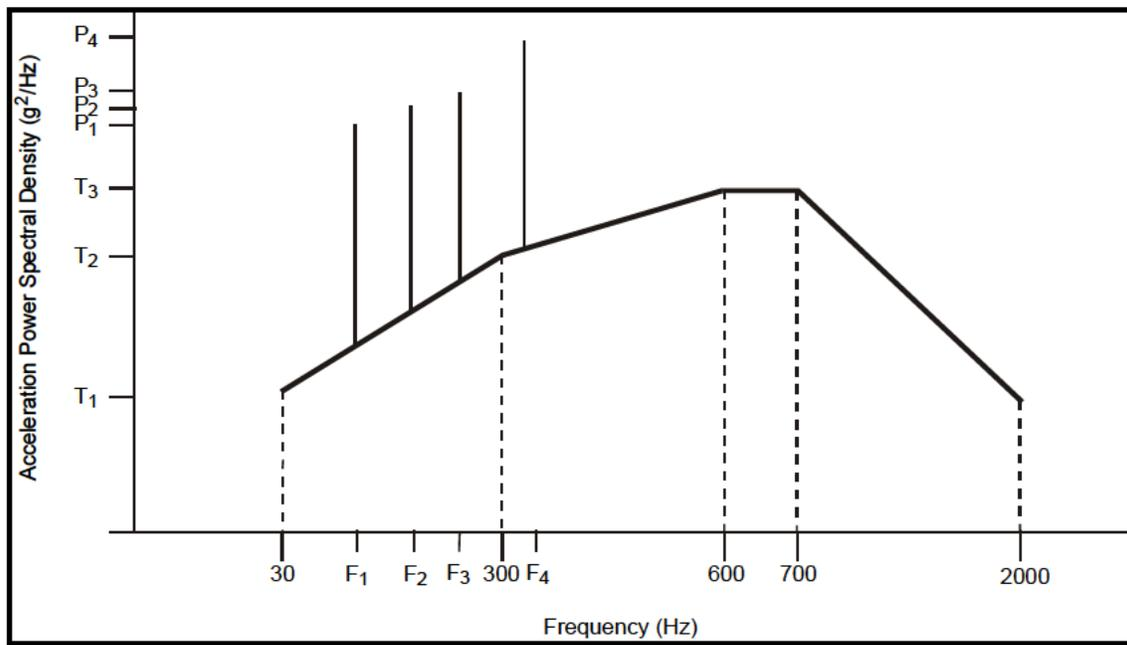


Figure 519.8C-1. Generalized gunfire induced vibration spectrum shape.

MIL-STD-810H
METHOD 519.8 ANNEX C

Table 519.8C-I. Suggested generalized parametric equations for gunfire-induced vibration.

$10 \log_{10} (T_j) = 10 \log_{10} (NF_1E) + H + M + W + J + B_j - 53 \text{ dB}$	
$10 \log_{10} (P_i) = 10 \log_{10} (T_3) + K_i + 17 \text{ dB}$	
for	
N	Maximum number of closely spaced guns firing together. For guns that are dispersed on the host aircraft, such as in wing roots and in gun pods, separate vibration gunfire test spectra are determined for each gun location. The vibration levels, for test purposes, are selected for the gun that produces the maximum vibration levels.
E	Blast energy of gun (see Table 519.8C-III).
H	Effect of gun standoff distance, h (see Figure 519.8C-4).
M	Effect of gun location $M = 0$ unless a plane normal to the axis of the gun barrel and located at the muzzle of the gun does not intersect the aircraft structure, then $M = -6 \text{ dB}$.
W	Effect of weight of the equipment to be tested (use Figure 519.8C-5). If the weight of the materiel is unknown, use $W = 4.5 \text{ kilograms (10 lbs)}$.
J	Effect of the materiel's location relative to air vehicle's skin (use Figures 519.8C-2 and 519.8C-6).
B_j	Effect of vector distance from the gun muzzle to the materiel location (see Figure 519.8C-7).
F_1	Gunfiring rate where $F_1 =$ fundamental frequency from Table 519.8C-II ($F_2 = 2F_1, F_3 = 3F_1, F_4 = 4F_1$)
T_j	Test level in g^2/Hz
P_i	Test level for frequency F_i in g^2/Hz (where $i = 1$ to 4)
K_i	Effect of vector distance on each vibration peak, P_i (see Figure 519.8C-8).

Note: These equations are in metric units. The resultant dB values are relative to $1 \text{ g}^2/\text{Hz}$.

MIL-STD-810H
METHOD 519.8 ANNEX C

Table 519.8C-II. Typical gun configurations associated with aircraft classes.

Aircraft/Pod	Gun (Quantity)	Location	Firing Rate		Capacity
			Rnds/Min	Rnds/Sec	
A-4	MK12 (2)	Wing roots	1000	16.6	100/Gun
A-7D	M61A1 (1)	Nose, left side	4000 & 6000	66.6 & 100	1020
A-10	GAU-8/A (1)	Nose	2100 & 4200	35 & 70	1175
A-37	GAU-2B/A (1)	Nose	6000	100	1500
F-4	M61A1 (1)	Nose	4000 & 6000	66.6 & 100	638
F-5E	M39 (2)	Nose	3000	50	300/Gun
F-5F	M39 (1)	Nose	3000	50	140
F-14	M61A1 (1)	Left side of nose	4000 & 6000	66.6 & 100	676
F-15	M61A1 (1)	Right wing root	4000 & 6000	66.6 & 100	940
F-16	M61A1 (1)	Left wing root	6000	100	510
F-18	M61A1 (1)	Top center of nose	4000 & 6000	66.6 & 100	570
F-111	M61A1 (1)	Underside of fuselage	5000	83.3	2084
GEPOD 30	GE430 (1) (GAU-8/A)	POD	2400	40	350
SUU-11/A	GAU-2B/A (1)	POD	3000 & 6000	50 & 100	1500
SUU-12/A	AN-M3 (1)	POD	1200	19	750
SUU-16/A	M61A1 (1)	POD	6000	100	1200
SUU-23/A	GAU-4/A (1)	POD	6000	100	1200

Table 519.8C-III. Gun specifications.

Gun	Gun Caliber, c		Blast Energy, E (J)*
	mm	in	
GAU-2B/A	7.62	0.30	6,700
GAU-4/A	20	0.79	74,600
GAU-8/A	30	1.18	307,500
AN-M3	12.7	0.50	26,000
M3	20	0.79	83,000
M24	20	0.79	80,500
M39	20	0.79	74,600
M61A1	20	0.79	74,600
MK11	20	0.79	86,500
MK12	20	0.79	86,500

*joules (J) x 0.7376 = foot-pounds

MIL-STD-810H
METHOD 519.8 ANNEX C

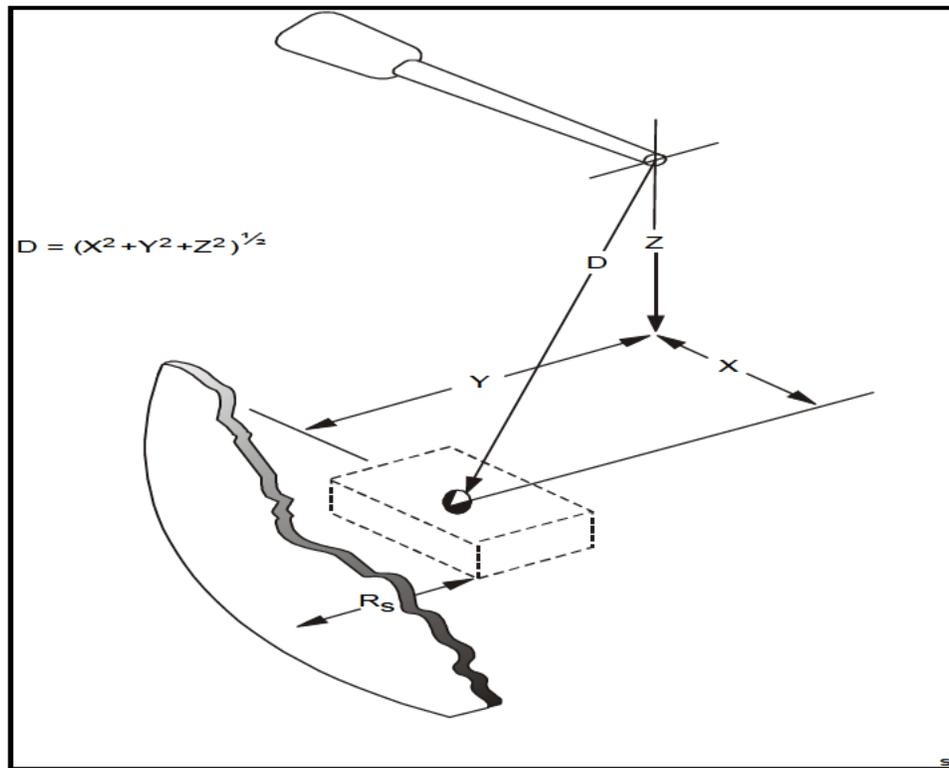


Figure 519.8C-2. The distance parameter (D) and the depth parameter (Rs)

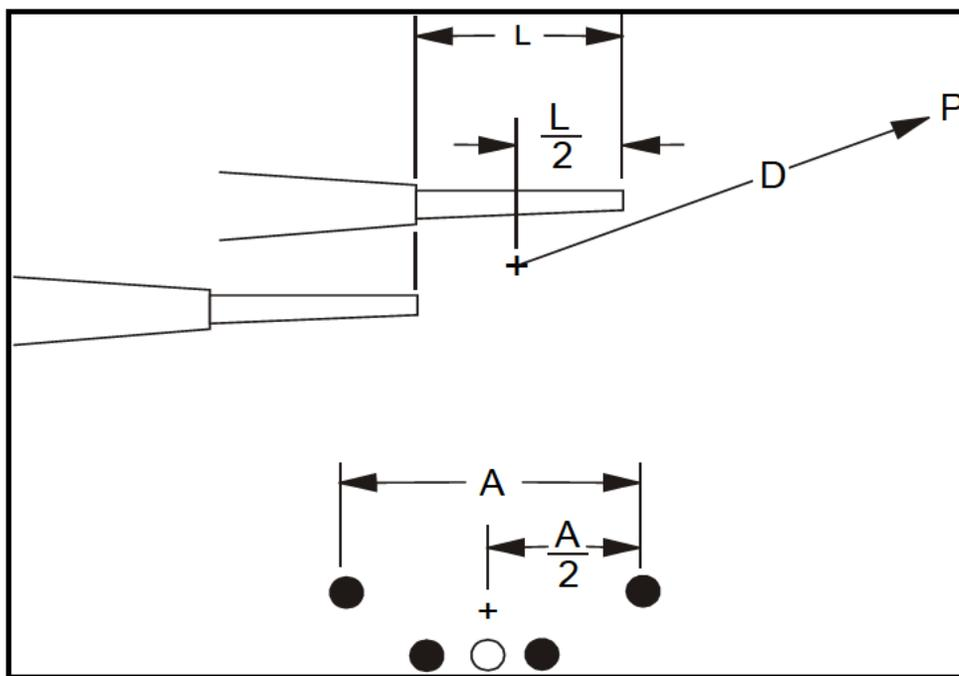


Figure 519.8C-3. Multiple guns, closely grouped.

MIL-STD-810H
METHOD 519.8 ANNEX C

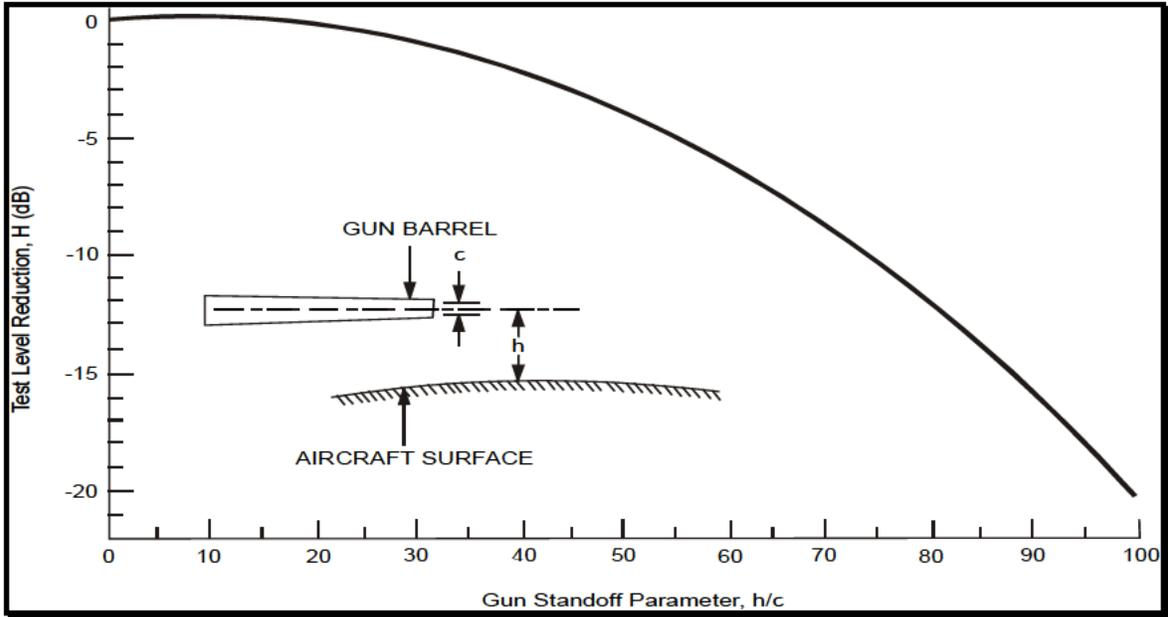


Figure 519.8C-4. Test level reduction due to gun standoff parameter.

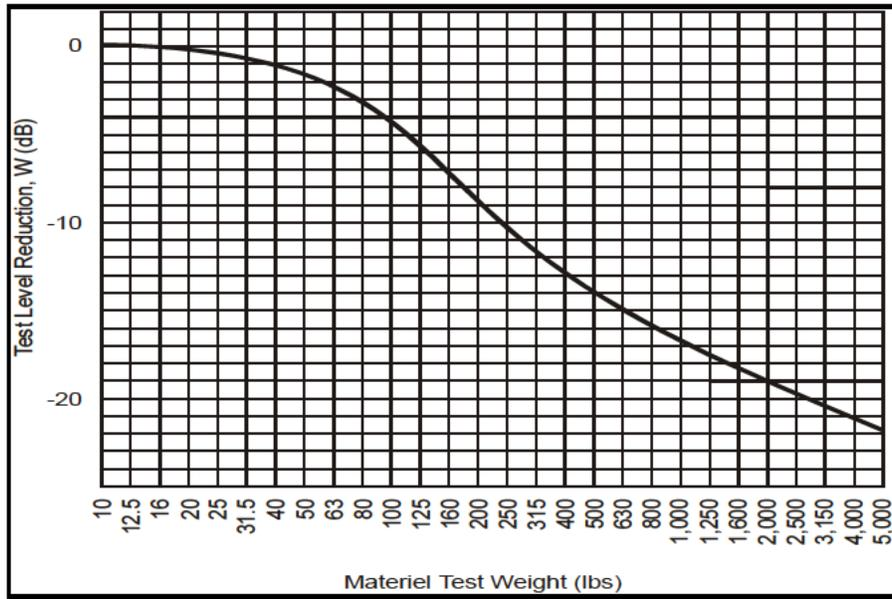


Figure 519.8C-5. Test level reduction due to materiel mass loading.

MIL-STD-810H
METHOD 519.8 ANNEX C

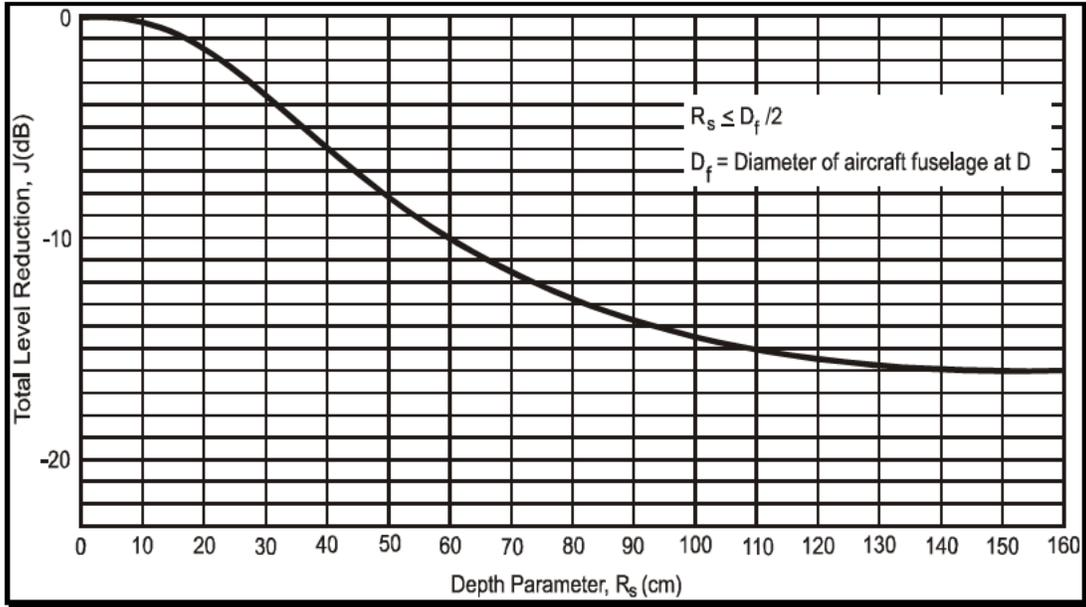


Figure 519.8C-6. Test level reduction due to depth parameter.

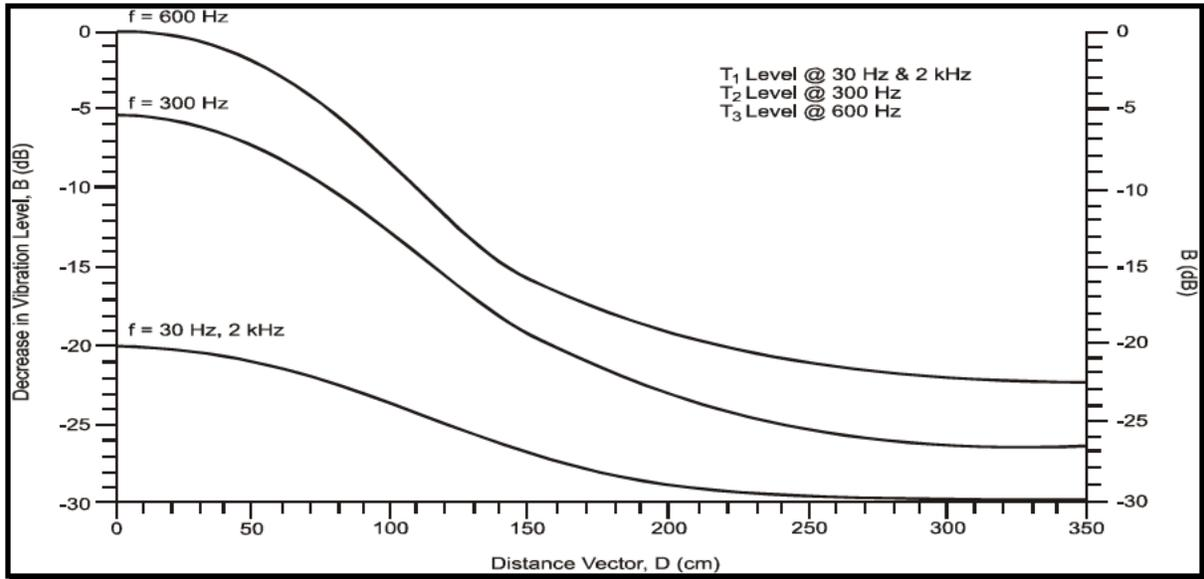


Figure 519.8C-7. Decrease in vibration level with vector distance from gun muzzle.

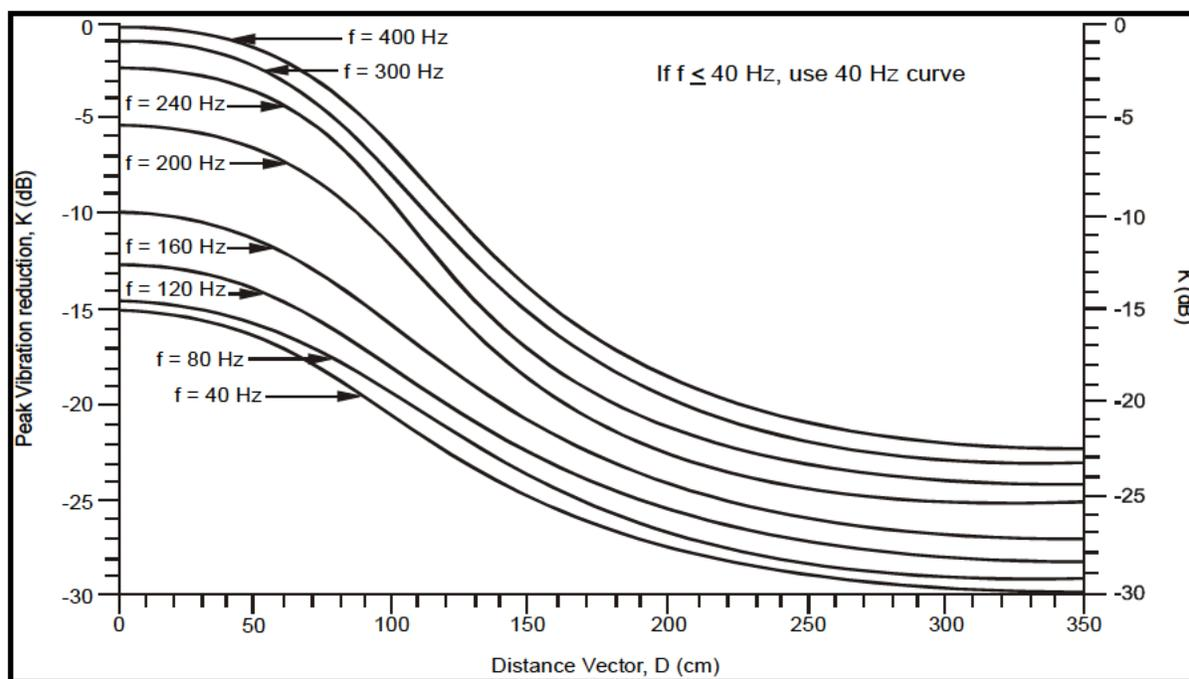
MIL-STD-810H
METHOD 519.8 ANNEX C

Figure 519.8C-8. Gunfire peak vibration reduction with distance.

The key geometrical relations used to determine the predicted vibration spectra are the following four geometrical factors:

- Vector distance (D).** The vector distance from the muzzle of the gun to the mean distance between materiel support points as shown on Figure 519.8C-2. For configurations involving multiple guns, the origin of vector D is determined from the centroidal point of the gun muzzle, as shown on Figure 519.8C-3. Figure 519.8C-7 and Figure 519.8C-8 provide for spectra reduction factors related to D for the random spectra and the discrete frequency spectra, respectively.
- Gun standoff distance (h).** The distance normal to the aircraft's surface as shown on Figure 519.8C-4.
- Depth parameter (R_s).** The distance normal to the aircraft's skin to the materiel location inside the aircraft. If R_s is unknown, use $R_s = 7.6$ cm (3 in.) (see Figure 519.8C-2). Figure 519.8C-6 provides spectra reduction factors related to R_s .
- Gun caliber.** Table 519.8C-III defines the gun caliber parameter, c, in millimeters and inches. For this procedure, base the vibration peak bandwidths consistent with windowed Fourier processing on in-service measured materiel response data if available. When such in-service data are not available, the vibration peak bandwidths can be calculated as:

For cases where the gun firing rate changes during a development program or the gun may be fired at a sweep rate, it is desirable to either (1) perform sinusoidal sweeps within the proposed bandwidth for the fundamental and each harmonic, or (2) apply narrowband random vibration levels provided the sweep frequency bandwidth is not too large. This technique may over-predict those frequencies where the attachment structure or materiel responses become significantly nonlinear. Likewise, for those cases in which the attachment structure or materiel resonances coincide with the frequencies in the gunfire environment, the materiel vibration response could be under-predicted. The practitioner should clearly understand the options available and inherent limitations in the vibration control system software.

MIL-STD-810H
METHOD 519.8 ANNEX C

2.3 Duration of Test.

Use a duration for the gunfire vibration test in each of the three axes that is equivalent to the expected total time the materiel will experience the environment in in-service use. This duration may be conservatively estimated by multiplying the expected number of aircraft sorties in which gun firing will occur by the maximum amount of time that gun firing can occur in each sortie. The number of sorties in which gunfire will occur will be associated with planned aircraft training and combat use rates, but will generally be in the vicinity of 200 to 300 sorties. The maximum time of gunfire per sortie can be determined from Table 519.8C-II by dividing total rounds per aircraft by the firing rate. When a gun has more than one firing rate, perform the test using both firing rates, with test time at each firing rate based on the expected proportion of time at each firing rate for in-service use. The guns carried by an aircraft are generally fired in short bursts that last a few seconds. Testing to a gunfire environment should reflect a form of in-service use in compliance with the test plan. For example, vibration could be applied for two seconds followed by an eight-second rest period during which no vibration is applied. This two-second-on/eight-second-off cycle is repeated until the total vibration time equals that determined for the aircraft type and its in-service use. This cycling will prevent the occurrence of unrealistic failure modes due to vibration isolator overheating or buildup of materiel response in continuous vibration. Intermittent vibration can be achieved by several means including (1) the interruption of the exciter input signal, and (2) a waveform replication strategy for transient vibration discussed in Annex A.

2.4 Spectrum Generation Techniques.

Using the prediction method gunfire materiel response vibration may be characterized by broadband random vibration with four vibration peaks that occur at the first three harmonics and the fundamental frequency of the firing rate of the onboard guns. Part 2 of this annex prescribes two methodologies for practically implementing this in laboratory testing. Virtually all modern vibration control system software packages contain a provision for performing a gunfire vibration test based on this form of predicted SOR spectra. Use of the procedures for generating and executing a SOR test is no longer permissible.

MIL-STD-810H
METHOD 519.8 ANNEX C**PART 2 – IMPLEMENTATION OF PREDICTED SPECTRUM METHODOLOGY FOR
PRELIMINARY MATERIEL DESIGN****1. SCOPE.****1.1 Purpose.**

The purpose of Part 2 of Annex C is to provide ad hoc methods for taking a predicted form of SOR spectrum and generating a time history having the form of a repeated shock with an ASD estimate that matches both the continuous and discrete spectrum. The repeated shock has the same period as the frequency of the fundamental harmonic of the predicted spectrum.

There are at least two ad hoc methodologies for generating repetitive shock time histories matching a form of SOR spectrum. Both methodologies are described briefly in this Annex. The first methodology is termed a Time Domain Windowed Pulse (TDWP) and the second methodology is termed a Random Modulated Harmonic Pulse (RMHP). The form of implementation in both methodologies is strikingly similar but differs in fundamental ways. TDWP relies upon a time domain windowing with an exponential window that has frequency components outside the principal gunfire bandwidth. The RMHP relies upon frequency domain implementation and development of a random pulse form with correct frequency domain properties. The methodologies are termed ad hoc since there is no attempt to “fit” a gunfire measurement time history. Both techniques provide a time history that has the outward appearance of a repetitive pulse gunfire environment.

1.2 Time Domain Windowed Pulse (TDWP).**1.2.1 Introduction.**

This ad hoc methodology uses the fact that predicted spectrum has a fundamental frequency and it is assumed that this fundamental frequency dominates the time history generation. A properly normalized exponential form window having a period corresponding to the fundamental period of the predicted spectrum allows time domain windowing of a stationary time history with the predicted continuous/discrete spectrum and generates a form of “repeated shock” at the gun firing rate. The three harmonics of the fundamental represented in the predicted spectrum provide correct amplitudes for the discrete spectrum. This methodology is effective because in general the frequency content of the discrete spectrum is fundamentally “stochastically independent” of the frequency content of the continuous spectrum with the exponential window providing the correct fundamental frequency and the three harmonics are unaffected when viewed as convolution of the exponential window in the frequency domain with the harmonic frequencies.

1.2.2 Outline of Implementation.

The following steps are outlined for implementation. A detailed discussion is found in Reference 6.1 k.

- a. Generate a normalized deterministic pulse of exponential form of duration of the period of the fundamental of the predicted spectrum
- b. Generate a stationary random bandlimited Gaussian time history of arbitrary duration
- c. Shape the spectrum of the band limited time Gaussian time history to the shape of the continuous spectrum and add discrete components at the three harmonic frequencies.
- d. Multiply the deterministic exponential pulse block times the stationary time history with the correct continuous/discrete spectrum block by block
- e. Compute the ASD estimate and compensate for any resulting harmonic distortion
- f. Execute the time history under TWR according to the LCEP gunfire event description

MIL-STD-810H
METHOD 519.8 ANNEX C

1.3 Random Modulated Harmonic Pulse (RMHP).

1.3.1 Introduction.

This ad hoc methodology uses the fact that predicted spectrum has an associated harmonic pulse composed of the four fundamental frequencies. It is assumed that these four discrete frequency components add and are of zero phase with respect to one another. This construction provides a form of “harmonic pulse”. Since the continuous and discrete spectrums are stochastically independent of one another they can be added to provide the exact predicted spectrum. However, as it is easy to demonstrate the resulting “additive” model does not have time history characteristics of a measured gunfire pulse such as high kurtosis. If the generated pulse is multiplied by the Gaussian time history with the appropriate continuous spectrum i.e., the deterministic pulse is modulated by the random time history, and any distortion from the predicted spectrum is removed in the frequency domain the resulting time history has a form or random time history with a degree of kurtosis differing from typical random vibration kurtosis. Analysis of the generated time history reveals an underlying “random pulse” where the fundamental and harmonic components have a non-zero relative phase. The stochastic generation must be such that the fundamental and three harmonic frequencies coincide with FFT Fourier frequencies (which is not a severe limitation).

1.3.2. Outline of Implementation.

The following steps are taken for implementation. A detailed discussion is found in Reference 6.1.1.

- a. Generate a deterministic pulse composed of zero phase summation of the fundamental and three harmonic components of the predicted spectrum. Choose the digital sequence sample rate such that it has the harmonic frequencies coincide with FFT Fourier frequency lines i.e., the Fourier frequencies.
- b. Generate a stationary random bandlimited Gaussian time history of arbitrary duration
- c. Shape the stationary random bandlimited Gaussian time history to the continuous spectrum provided by the prediction.
- d. Modulate the deterministic pulse by multiplying it by blocks of stationary random time history
- e. Using the FFT over a long portion of time history correct the harmonic components lying on the Fourier frequencies to the correct amplitudes leaving the phase as random (this may be an iterative procedure)
- f. Execute the time history under TWR according to the LCEP gunfire event duration

Note: This methodology introduces kurtosis differing from stationary random vibration kurtosis into the testing and is random in the sense that the underlying pulse in the generated time history generally is un-symmetric and does not have zero boundary conditions.

2. RECOMMENDED PROCEDURES.

2.1 Recommended Procedure.

For aircraft vibration for materiel mounted in the aircraft with no available measured data, use this procedure with the prediction methodology implemented with the TDWP or RMHP.

2.2 Uncertainty Factors.

This procedure contains two sources of uncertainty. First, there is uncertainty in application of the SOR prediction methodology and determining a SOR spectrum. Second, there is uncertainty in transferring information in the SOR prediction methodology to a form of laboratory test that might be appropriate for materiel design considerations.

2.2.1 SOR Prediction Methodology Uncertainty.

There is substantial uncertainty in general levels because of the sensitivity of the gunfire environment to gun parameters and geometrical configuration. It may be appropriate to increase levels or durations in order to add a degree of conservativeness to the testing. Change in levels, durations, or both for the sake of increasing test conservativeness must be backed up with rationale and supporting assessment documentation. Since extreme spectra prediction levels do not necessarily provide test inputs that correlate with measured data (for the same geometrical configuration), the uncertainty in damage potential is increased substantially as the predicted spectra increase in level; i.e., testing with this procedure may be quite un-conservative.

MIL-STD-810H
METHOD 519.8 ANNEX C

2.2.2 Stochastic TWR Generation Uncertainty.

There is uncertainty in the stochastic implementation of either TDWP or RMHP. Materiel response to gunfire environment either via air borne or structure borne stimulation is complex in part because of the transmission path and the medium through which the “gunfire pulse” must travel to impact the materiel. Neither TDWP nor RMHP can account for the physical phenomenon or its effects on the materiel. TDWP can control certain time domain properties by variation in the exponential pulse and is transparent in this manner. TDWP is generally for high level gunfire response where there is a substantial regularity in the pulse structure even though this pulse structure i.e., the exponential window could easily be varied deterministically or stochastically. RMHP is more uncontrolled but may be able to satisfy some of the higher order correlation information contained in gunfire records, in particular any periodically correlated aspects of gunfire, even though this has not been studied extensively. The random generated pulses can be generated, characterized, and stored for a more refined stochastic simulation. Just by repeated stochastic generation portions of time history record can be identified with targeted kurtosis values. Either technique can be said to be totally uncertain relative to what measurements might be obtained based upon the SOR prediction configuration.

MIL-STD-810H
METHOD 519.8 ANNEX C

(This page is intentionally blank.)

MIL-STD-810H
METHOD 520.5**METHOD 520.5****COMBINED ENVIRONMENTS****CONTENTS**

<u>Paragraph</u>	<u>Page</u>
1. SCOPE	1
1.1 PURPOSE	1
1.2 APPLICATION	1
1.3 LIMITATIONS.....	1
2. TAILORING GUIDANCE	2
2.1 SELECTING THE COMBINED ENVIRONMENTS METHOD	2
2.1.1 EFFECTS OF COMBINED TEMPERATURE/HUMIDITY/VIBRATION/ALTITUDE ENVIRONMENTS.....	2
2.1.2 SEQUENCE AMONG OTHER METHODS.....	2
2.2 SELECTING PROCEDURES	3
2.2.1 PROCEDURE SELECTION CONSIDERATIONS	3
2.2.2 DIFFERENCE AMONG PROCEDURES.....	3
2.2.2.1 PROCEDURE I - ENGINEERING DEVELOPMENT	3
2.2.2.2 PROCEDURE II - FLIGHT OR MISSION SUPPORT	3
2.2.2.3 PROCEDURE III – PLATFORM ENVELOPE	4
2.2.3 SELECTING COMBINED ENVIRONMENTS	4
2.2.4 ENVIRONMENTAL STRESSES.....	4
2.2.4.1 THERMAL STRESS	4
2.2.4.1.1 BAY CONDITIONS.....	5
2.2.4.2 ALTITUDE STRESS.....	6
2.2.4.3 HUMIDITY STRESS.....	8
2.2.4.4 ELECTRICAL STRESS	8
2.2.4.4.1 AC & DC SYSTEM NORMAL OPERATION STRESSES	9
2.2.4.4.2 NORMAL ON/OFF CYCLING OF MATERIAL OPERATION	12
2.2.4.5. VIBRATION STRESS	12
2.3 DETERMINE TEST LEVELS AND CONDITIONS	14
2.3.1 TEST CYCLE DEVELOPMENT	14
2.4 TEST ITEM CONFIGURATION.....	17
3. INFORMATION REQUIRED.....	17
3.1 PRETEST.....	17
3.2 DURING TEST.....	17
3.3 POST TEST.....	17
4. TEST PROCESS	18
4.1 TEST FACILITY	18
4.1.1 POWER SUPPLIES.....	18
4.2 CONTROLS	18
4.3 TEST INTERRUPTION	18
4.3.1 INTERRUPTION DUE TO FACILITY MALFUNCTION.....	18
4.3.2 INTERRUPTION DUE TO TEST ITEM OPERATION FAILURE	18
4.3.3 SCHEDULED INTERRUPTIONS	19
4.4 TEST EXECUTION	19
4.4.1 PREPARATION FOR TEST.....	19
4.4.1.1 PRELIMINARY STEPS.	19
4.4.1.2 PRETEST STANDARD AMBIENT CHECKOUT.....	19
4.4.2 PROCEDURE I – ENGINEERING DEVELOPMENT.....	20
4.4.3 PROCEDURE II – FLIGHT OR MISSION SUPPORT.....	20

MIL-STD-810H
METHOD 520.5

4.4.3.1	NON-OPERATION/GROUND SOAK	20
4.4.3.2	START UP/TAXI	20
4.4.3.3	CLIMB TO CRUISE/SURVEILLANCE	21
4.4.3.4	CRUISE/SURVEILLANCE	21
4.4.3.5	ATTACK	22
4.4.3.6	DESCENT/LANDING.....	22
4.4.3.7	MAINTENANCE.....	23
4.4.4	PROCEDURE III – PLATFORM ENVELOPE	25
4.4.4.1	PROCEDURE III – STEPS.....	33
5.	ANALYSIS OF RESULTS	37
5.1	Analysis of Test Results	37
5.2	Analysis of Failures.....	37
6.	REFERENCE/RELATED DOCUMENTS	37
6.1	REFERENCED DOCUMENTS.....	37
6.2	RELATED DOCUMENTS.....	38

FIGURES

FIGURE 520.5 -1.	TEST PROFILE GENERATION FLOW DIAGRAM	16
FIGURE 520.5 -2.	PROCEDURE II- PROFILE NOTIONAL EXAMPLE	24
FIGURE 520.5 -3A.	PROCEDURE III- PLATFORM ENVELOPE OPTION 1EXAMPLE	31
FIGURE 520.5 -3B	PROCEDURE III- PLATFORM ENVELOPE OPTION 2 EXAMPLE.....	32
FIGURE 520.5A-1.	SCHEMATIC MISSION PROFILE, ALTITUDE, AND MACH NUMBER	A-1

TABLES

TABLE 520.5-I.	TYPICAL SUPPLEMENTAL COOLING AIR PARAMETERS, F-15 PLATFORM LCEP EXAMPLE.....	6
TABLE 520.5-II.	PRESSURE VS ALTITUDE CONVERSION EQUATIONS	7
TABLE 520.5-III	INPUT VOLTAGE AND FREQUENCY TEST SCHEDULE	9
TABLE 520.5-IV.	AIRCRAFT ELECTRICAL POWER CHARACTERISTICS	10
TABLE 520.5-V	GROUND VEHICLE 28 VDC CHARACTERISTICS	11
TABLE 520.5-VI.	RTCA DO-160 POWER CHARACTERISTICS	11
TABLE 520.5-VII.	DEFAULT FUNCTIONAL VIBRATION TEST CRITERIA	13
TABLE 520.5-VIII.	TEST PARAMETER SELECTION/PROFILE DEVELOPMENT	15
TABLE 520.5-IX.	PROCEDURE I AND III - TEST CYCLE TEMPLATE	26
TABLE 520.5A-I.	AMBIENT OUTSIDE AIR TEMPERATURES (HOT ATMOSPHERE MODEL)	A-2
TABLE 520.5A-II.	AMBIENT OUTSIDE AIR TEMPERATURES (COLD ATMOSPHERE MODEL)	A-2
TABLE 520.5A -II.	AMBIENT OUTSIDE AIR TEMPERATURES (WARM MOIST ATMOSPHERE MODEL).....	A-3

MIL-STD-810H
METHOD 520.5**METHOD 520.5**
COMBINED ENVIRONMENTS

NOTE: The example profiles provided in this method do not represent specific platform/mission scenarios and are not to be used as default profiles. Tailoring is essential. Select methods, procedures, and parameter levels based on the tailoring process described in Part One, paragraph 4.2.2, and Annex C. Apply the general guidelines for laboratory test methods described in Part One, paragraph 5 of this standard.

Due to extensive revision to this method, no change bars have been provided.

1. SCOPE.**1.1 Purpose.**

The purpose of this test is to help determine the synergistic effects of combinations of temperature, altitude, humidity, input electrical power, and vibration on airborne electronic and electro-mechanical materiel with regard to safety, integrity, and performance during ground and flight operations. The synergistic effects may induce failures that would not be exhibited during individual environment testing. New to this method is the addition of input electrical power as an environment; to include voltage/frequency variations, and transients (if applicable) which are inherent to the system. While it is virtually impossible to replicate the complex mix of environments which can be seen during transport, storage, operation, and maintenance, the intent is to apply representative combinations of stresses to the materiel to determine performance and capabilities.

1.2 Application.

NOTE: This Method is not intended to be used in lieu of Method 507 due to the cyclic and cumulative exposure required for Humidity testing. Additionally, this Method is not intended to be used in lieu of 500, 501, 502, and/or 514 unless properly tailored and authorized in the requirements documents.

- a. This Method was developed and based on rotor or fixed wing aircraft/platforms. The test procedures are applicable to all aircraft equipment. However, with tailoring, this method may also be applicable to other commodities; i.e., ground vehicles, support equipment, man-mounted equipment, etc.
- b. Use this Method to evaluate materiel to be deployed in/on aircraft or ground support equipment where temperature, altitude, humidity, input electrical power, and vibration, or any combination of these, may induce failures.
- c. This Method is primarily intended for actively powered materiel operated at altitude, i.e., aircraft and missile electrical/electronic equipment, mission equipment, electro-mechanical equipment, etc. This Method may be used for engineering development, for support of developmental and/or functional testing, and for other similar purposes.
- d. Use this Method to provide an option for use of vibration in combination with the climatic elements, or for use of the climatic tests in combination with each other. This is often noted throughout the text. Generally, the combined environment test simulates those synergistic environmental effects that occur for the majority of the deployment life.

1.3 Limitations.

- a. Limit use of this Method to evaluating the combined effects of three or more of the following environments: temperature, altitude, humidity, input electrical power, and vibration.
- b. This Method does not normally apply to unpowered materiel transported as cargo in an aircraft.

MIL-STD-810H
METHOD 520.5

- c. The tailored test cycle should not include short duration vibration events or those that occur infrequently in the test cycle. These events include firing of on-board guns, extreme aircraft motion, and shock due to hard landings. Test for these events separately using the appropriate test method.
- d. This Method is not intended to be used for temperature/vibration testing, unrelated to the synergistic environmental test combinations detailed in paragraph 2.2.3. Refer to Method 514.
- e. This Method is not intended to be used to test materiel to be installed or operated in space vehicles, aircraft or missiles that fly at altitudes above 21,300 m (70,000 ft).

2. TAILORING GUIDANCE.

2.1 Selecting the Combined Environments Method.

After examining requirements documents, apply the tailoring process in Part One of this Standard to determine where these combined forcing functions of temperature, altitude, humidity, input electrical power, and vibration are foreseen in the life cycle of the materiel in the real world. Use this Method to evaluate the synergistic stresses based on detailed analysis as defined in the Life Cycle Environmental Profile (LCEP), mission profile, and the platform requirements/specification. If appropriate, tailor non-operational environments into the combined environmental cycle. Use the following to aid in selecting this Method and placing it in sequence with other methods.

2.1.1 Effects of Combined Environments.

Temperature, altitude, humidity, input electrical power, and vibration can combine synergistically to produce the following equipment failures. The synergistic effects may induce failures that would not be exhibited during individual environment testing. In addition to unique effects, the synergistic environments may amplify the stress effects when compared to the effects of individual environments, to include power effects. The following examples are not intended to be comprehensive. For additional information refer to the individual methods.

- a. Shattering of glass vials and optical materiel.
- b. Binding or loosening of moving parts.
- c. Separation of constituents.
- d. Performance degradation in electronic components due to parameter shifts.
- e. Electronic optical (fogging) or mechanical failures due to rapid water or frost formation.
- f. Cracking of solid pellets or grains in explosives.
- g. Differential contraction or expansion of dissimilar materials.
- h. Deformation or fracture of components.
- i. Cracking of surface coatings.
- j. Leakage of sealed compartments.
- k. Failure due to inadequate heat dissipation.
- l. If the material is powered, component over-temperature failures.
- m. Printed Circuit Card failures due to short circuiting.
- n. Failure of Electromagnetic Interference (EMI) filters.
- o. Errors due to input electrical power frequency variances.

2.1.2 Sequence Among Other Methods.

- a. General. Use the anticipated life cycle sequence of events as a general sequence guide (see Part One, paragraph 5.5).
- b. Unique to this Method. Procedure I is intended to be used before final materiel designs are fixed. If vibration is performed separately from the remaining combined environments, vibration shall be performed first.

MIL-STD-810H
METHOD 520.5

2.2 Selecting Procedures.

Note: For risk reduction it is recommended that single environment tests be performed prior to these procedures to verify system performance under discrete environmental parameters.

This Method includes three procedures:

- a. Procedure I - Engineering Development.
- b. Procedure II - Flight or Mission Support.
- c. Procedure III - Platform Envelope.

2.2.1 Procedure Selection Considerations.

The choice of test procedure is determined by the developmental phase of the equipment (Design, Specific Mission, Troubleshooting, or Envelope Verification).

2.2.2 Difference Among Procedures.

While all of the procedures cover the same forcing functions, they differ on the basis of test severity, combination of forcing functions, and applicable mission(s) as defined in the following:

Procedures I and III: These procedures encompass the full operational envelope as defined by the equipment LCEP, the platform/equipment specification, and as further defined for the current/projected installation location(s). The stress levels used in Procedure I may exceed the LCEP parameters in order to establish design margins. The stress levels used in Procedure III would apply to a UUT with a more mature design and would incorporate the specification test levels, to include the maximum range of climatic, input electrical power, vibration, and operational modes/conditions.

Procedure II: This procedure is constrained to the climatic, dynamic, and operational parameters defined for a specific geophysical and climatic area/model. This is further defined by the specific micro-environment in which the equipment operates (equipment bay, cockpit, etc.), local electrical power quality, and operational modes. Test results are relevant only for operation within the specified envelope.

2.2.2.1 Procedure I - Engineering Development.

Use Procedure I to help find design defects in new or modified equipment while it is still in the development stage. A combined environment test is useful for this purpose since it will reveal synergistic failures. The primary purpose of this test is to uncover any anomaly, with the exact cause being secondary. A root cause analysis is then performed to determine the corrective action. Subsequent testing, to aid in the root cause analysis, may be enhanced by using higher stress levels than the item is likely to encounter on a regular basis in the field. Test duration shall be based on time required to induce expected failure modes, such as those listed in paragraph 2.1.1. Test parameters may be chosen to emphasize specific environmental effects. However, using limited environments and stressing materiel items beyond realistic limits may induce failures that would not occur under realistic conditions. This procedure is not a substitute for Environmental Stress Screening (ESS) or Highly Accelerated Life Test (HALT) testing. Given these cautions, perform the Procedure I steps specified in the Test Parameter Selection/Profile Development Table (Table 520.5-VIII).

2.2.2.2 Procedure II - Flight or Mission Support.

This procedure is performed in preparation for a specific mission scenario or functional testing; and also for troubleshooting of fielded materiel exhibiting specific mission problems. This can include issues which only occur during specific combined environment(s) and which may be resolved when these conditions no longer exist. Its purpose is to use laboratory conditions to evaluate and resolve materiel issues pertinent to specific mission scenarios and to resolve issues prior to resumption of flight testing of developmental or fielded materiel. In addition, this procedure can be used where a standard qualification process is not feasible due to deployment schedule constraints; i.e., urgent user needs. These types of programs require performance during specific missions but normally are not required to operate to the full platform envelope.

This test is not accelerated; the damage accumulation in the test should be no faster than in operational or in-flight testing. Therefore, development hardware can be interchanged between laboratory and flight or functional testing. In general, use a test duration representative of the design mission or, if troubleshooting, sufficient to identify materiel

MIL-STD-810H
METHOD 520.5

problem (may be iterative). For troubleshooting it may be necessary to replicate the life cycle history of the materiel. This procedure is not intended to be used in lieu of Procedure III. Perform the Procedure II steps specified in the Test Parameter/Profile Development Table (Table 520.5-VIII).

2.2.2.3 Procedure III - Platform Envelope.

The Platform Envelope test is intended to demonstrate compliance with specific platform/equipment specification requirements of combined synergetic environmental conditions. This testing emphasizes the most significant environmental stress conditions and combination of stress conditions; in accordance with the operational envelope as determined by the LCEP, specification, and developmental maturity of the materiel. Include in the platform envelope test the maximum amplitude of each stress and any unique combinations of stress types. Use caution in the application of maximum amplitude combinations that would expose the materiel to unrealistic conditions. The intent is to demonstrate maximum conditions that a specific platform may expose the materiel to. Use a test duration of a minimum of 10 cycles. For power cycling the input power shall be cycled such that the electrical stresses are balanced throughout the test. Cycling shall start at nominal, then high voltage, low voltage, etc.; ending with nominal. Additional cycles may be conducted, but platforms are rarely exposed to their maximum envelope conditions and a failure discovered in subsequent cycles may be caused by unrealistic extended exposures. Perform the Procedure III steps specified in the Test Parameter/Profile Development Table (Table 520.5-VIII).

2.2.3 Selecting Combined Environments.

The intent is to identify all synergistic environmental combinations from the LCEP and to develop a representative test profile to verify that the materiel operates properly throughout the LCEP derived environments, within a single test. The relevant environments are temperature, altitude, humidity, input electrical power, and vibration. However, this method can be tailored to perform a series of combined environmental tests providing that all synergistic effects can be evaluated. An example of a series of combined tests would be the performance of a temperature, altitude, humidity, input electrical power test, and vibration. Apply the guidance in section 2.3. Each combined environment test shall be completed in single climatic chamber to maintain materiel conditions and eliminate unintended environmental stresses. Test items shall not be transferred between chambers due to combined environment equipment capability limitations.

2.2.4 Environmental Stresses.

- a. Determine environmental stresses including temperature, supplemental cooling, altitude, humidity, and input electrical stresses, and vibration.
- b. Determine test levels (based on measured data, if available, or from the LCEP) for each stress from the mission profile information in the manner described in paragraphs 2.2.4.1 through 2.2.4.5. Other information, such as engine rpm or data on the platform's system environmental control system (ECS) may be needed.

2.2.4.1 Thermal Stress.

The thermal stresses that materiel experiences during a mission is dependent upon the localized ambient temperature, induced/contributing thermal influences (solar, reflected radiation, adjacent heat producing equipment, etc.), altitude and humidity conditions in the equipment location. This may be either external or an internal compartment or bay. Contributing factors, such as flight conditions, power requirements, and the performance of supplemental cooling to the materiel are to be considered. (Thermal stresses shall consider steady state conditions, transition temperatures, ramp rates, and extremes for both operational and non-operational conditions.)

- a. Ambient worldwide climatic extremes are found in MIL-HDBK-310. The ground level ambient temperatures are based on data from standard meteorological instrument shelters. They represent free air temperatures in the shade about 1.5 meters above the ground. The materiel ground soak temperatures in each mission are not necessarily directly correlated to the meteorological data. Ground soak temperatures are influenced by the albedo of the material, solar radiation, reflected radiation, heat from adjacent equipment, etc. Temperatures at altitude represent actual extreme high and low measurements, compiled from multiple data measurements. They may not represent conditions at a specific geophysical location. When determining air temperature change rates during ascent or descent conditions, the proper adiabatic lapse rate for the local atmospheric conditions (dry or moist,) shall be utilized. In addition to the highest/lowest recorded values, MIL-HDBK-310 also includes the 1, 5, 10, and 20 percent frequency of occurrence values. If used in preparing a thermodynamics analysis, then additional forcing functions (direct solar radiation, reflected radiation,

MIL-STD-810H
METHOD 520.5

adjacent equipment, etc.) must also be included in the analysis. The materiel thermal response during the transition from ground soak (non-operational/standby) conditions to operational conditions will demonstrate a thermal lag where the equipment temperature will lag the ambient temperature based on the equipment mass, material, and airflow conditions.

- b. The environmental test conditions for any test item are dependent on the local thermal environment; including the type of local cooling (supplemental cooling air, ram air, convective cooling, etc.), induced heating from solar radiation and other thermal radiators (engines, exhaust ducts, adjacent equipment, etc.), and heated air from adjacent convectively cooled equipment. Systems comprised of multiple line replaceable units (LRU) may be tested concurrently in one chamber if the LRUs all have the same local operational environment. Likewise, systems comprised of multiple LRUs shall be tested separately if the LRUs have different local environments.
- c. The thermal stress test parameters to be used in performance of Procedure II - Flight or Mission are derived from the specific mission segments of the selected platform flight profile. For troubleshooting of fielded materiel exhibiting specific mission problems, select the thermal environment of the mission segment (s) in which the problem exists. For mission unique programs, which will operate in specific geophysical areas, select all of the thermal conditions throughout the entire flight profile. Use of measured temperature from the platform is preferable. Use natural temperature conditions derived from standard atmospheric models and induced temperatures due to air friction against the platform exterior and/or solar loading for materiel that is mounted externally to the platform. If data is not available for bay/compartment temperatures, perform an analysis of typical Environmental Control Systems, induced, and natural conditions or obtain/acquire measured data for the area of concern. Many modern electronic avionic equipment record internal component temperatures and can be used to analyze the temperature conditions during testing of the bay or cabin compartment. By adjusting the chamber air temperature conditions with the equipment operating in the same operational mode, match the response temperature of the equipment as it would be in-flight. Choose the climatic region, Basic, Hot, Cold, Severe Cold, and Coastal/Ocean and use the 20% frequency of occurrence temperature for day or night as starting points for ground conditions of start-up, taxi, takeoff, and landing or measured data at the platform sight.
- d. The thermal stress test parameters to be used in performance of Procedure III - Platform Envelope are derived from the equipment/platform performance specifications and the LCEP. For equipment which is operated only during specific segments of the platform envelope, use the thermal parameters corresponding to the equipment's operational envelope. For equipment that is to be used on multiple platforms, use the worst case parameters for those platforms. Use caution, when applying parameters from multiple platforms, do not apply unrealistic combinations of environmental conditions. The duration of the thermal stresses shall be sufficient for thermal stabilization and representative of the anticipated durations determined by the LCEP.

2.2.4.1.1 Bay Conditions. (Reference MIL-STD-2218)

The effective air temperature within equipment bays must be determined in developing a test profile. Ram air will track the external temperature. Cold air at altitude may induce thermal shocks, and this condition must be considered when developing the test profile. For Environmental Control System (ECS) cooled equipment the ECS specification requirements must be met in regards to the cool down ramps and temperatures. See Table 520.5-I for an F-15 supplemental cooling example.

- a. Ram-air-cooled compartments. Use this section to determine the bay temperature for an avionics or system in a compartment that is ram-cooled. Utilize thermal analysis and/or thermal surveys to determine the effective air temperature in the compartment at specific altitude and temperature conditions. Determine the thermal stress in a ram-air-cooled compartment from the following relationship.

$$T_{\text{eff}} = T_{\text{amb}}[1 + 0.2M^2]$$

where:

T_{amb} = Ambient air temperature (K) at altitude being flown (Tables 520.5A-I, 520.5A-II, and 520.5A-III).

T_{eff} = Effective air temperature (K) as modified by air velocity cooling effects and used in the test cycle.

M = Mach number being flown

MIL-STD-810H
METHOD 520.5

- b. Environmental Control System conditioned supplemental-air-cooled bay. Use this section to determine the thermal stress for an avionics system located in a bay that receives its cooling from the platform ECS. To the extent possible, the effects of the ECS should be simulated in the chamber. If the ECS cannot be simulated in the chamber, utilize thermal analysis and/or thermal survey data to determine the effective air temperature in the compartment at specific altitude and temperature conditions. Determine the mass flow rate and temperature of supplemental air for each break point in the mission profile. Model the onboard ECS in terms of its primary components such as pressure regulators, heat exchanger, turbo machines, water separator, etc. If the heat load from these systems is significant, include the mass flow rate being injected into the bay and the location of other systems in the calculation.
- c. Materiel supplemental cooling thermal stress. Use this section to determine the effect for test items that require supplemental cooling from the platform. Evaluate the component for additional supplemental cooling not mentioned in the previous section. This cooling may be direct air or liquid cooling into the materiel or through a cold plate. For ECS systems that are open to the external environment, the mass flow rate shall be system temperature and mass flow rate parameters.)

Table 520.5-I. Supplemental cooling air parameters, F-15 platform LCEP example.

EQUIPMENT BAYS	Min Temp °C (°F)	Min Oper Temp °C (°F)	Max Temp °C (°F)	Max Oper Temp °C (°F)	Max Humidity (RH)	Mass Flow Rate (KG/Min)
Supplementally Cooled	-54 (-65)	-40 (-40)	60 (140)	54 (129)		---
Ram Air Cooled	-54 (-65)	-40 (-40)	60 (140)	54 (129)	75% at 43°C	---
Unconditioned	-54 (-65)	-40 (-40)	60 (140)	54 (129)		---
CREW STATION						
Open Areas	-54 (-65)	-40 (-40)	60 (140)	25 (77)		---
Behind Instrument Panels	-54 (-65)	-40 (-40)	100 (212)	100 (212)	75% at 43°C	---
Supplemental Cooling Airflow to Materiel	-51 (-60)	-51 (-60)	-54 (-65)	-54 (-65)	75% at 43°C	+0% of design -80% point

2.2.4.2 Altitude Stress.

Use altitude simulation to evaluate the effect of various pressures (high or low) across the platform envelope throughout the LCEP. Method 500 addresses the effects of low pressure as an individual forcing function. Method 520 addresses high and low pressure and its effects in conjunction with high/low temperatures and high/low humidity forcing functions, as well as the effects of the altitude ramp rate. Vibration may also be added as a forcing function.

For airborne materiel the pressure altitude has a direct effect on the thermal performance of the materiel (See paragraph 2.2.4.1.1 for additional information on bay conditions). Convective cooling is directly proportional to the density (mass per unit volume) of the surrounding air. At high altitude the air density is less, thus the air mass available for convective cooling is diminished. This will result in higher operational temperatures. This also applies to equipment receiving cooling air via an ECS. For an open system, where the system is open to the natural environment, the air velocity may be constant; however, the air mass flow rate will be reduced in proportion to the pressure. When performing altitude tests on ECS conditioned equipment care must be taken to match the mass flow rate with the appropriate altitude conditions.

Variations in air pressure will affect both environmental and hermetic seals. Under normal operation the environmental seals will allow the passage of gases into and out of the materiel in order to equalize pressure (breathing). Rapid pressure changes may result in damage to, or complete failure, of environmental seals. Damage to Electromagnetic Interference (EMI) seals may also occur. Hermetic seals may rupture due to pressure variations. The air mass internal to the hermetic seal remains constant; however, as the external pressure drops, the pressure differential may result in the seal being ruptured. Altitude ramp rates must be controlled to avoid an over test or under test. Unrealistic ramp

MIL-STD-810H
METHOD 520.5

rates will result in unintended results. The ramp rates shall comply with the maximum platform altitude ramp rates. Ramp rates that do not meet these requirements will result in an invalid test.

Altitude stress in conjunction with humidity is highly dependent upon the atmospheric model(s) (reference Annex A, Tables 520.5A-I thru 520A-III) in which the materiel is to be operated during its life cycle. For world wide deployment the combined worst case parameters shall be used. See paragraph 2.2.4.3 for the description of the synergistic altitude /humidity effects.

Changes in atmospheric pressure and air density may also effect the electrical characteristics of components and between components. Changes in air density will result in a variable air dielectric field, resulting in changes in capacitance between and within components. For high voltage materiel this may result in corona effects and arcing. Some types of capacitors may swell due to decreased air pressure, resulting in changes to their capacitance.

The test site and test chamber capabilities must also be considered when performing altitude tests. Most materiel specifications require that the materiel operate from Mean Sea Level (MSL) to some maximum altitude. However, most altitude test chambers are designed such that the maximum pressure corresponds to the site ambient pressure. For pressure sensitive materiel (altimeters, air data computers, pressure sensors, pressure switches, etc.), where it is required that testing be performed across the full operational pressure envelope, a test site, or test facility, shall be chosen that is capable of meeting the full pressure envelope of the materiel.

Table 520.5-II. Pressure vs Altitude Conversion Equations.

Equations for Pressure Versus Altitude	
Altitude	Pressure Equation
0 km < H ≤ 11 km (0 ft < H ≤ 36.1 kft)	$P(Pa) = 101325 \left[\frac{288.15 - 6.5(H)}{288.15} \right]^{5.2558}$ $\left(P(Pa) = 101325 \left[\frac{288.15 - 1.9812 \cdot H}{288.15} \right]^{5.2558} \right)$
11 km < H ≤ 20 km (36.1 kft < H ≤ 65.62 kft)	$P(Pa) = 22632.41 \cdot \exp \left[-\frac{(H - 11)}{6.34162} \right]$ $\left(P(Pa) = 22632.41 \cdot \exp \left[-\frac{(H - 36.089)}{20.806} \right] \right)$
20 km < H ≤ 32 km (65.62 kft < H ≤ 105 kft)	$P(Pa) = 5475.052 \left[\frac{216.65}{216.65 + (H - 20)} \right]^{34.16}$ $\left(P(Pa) = 5475.052 \left[\frac{216.65}{216.65 + (0.3048 \cdot H - 20)} \right]^{34.16} \right)$

Reference U.S. Standard Atmosphere (1976)

MIL-STD-810H
METHOD 520.5**2.2.4.3 Humidity Stress.**

Absolute humidity is the mass of water vapor in a specified volume of air. It may be expressed in many ways, but is generally specified as grams/m³ or parts of water vapor per million part of dry air (ppm). Data for the highest and lowest worldwide absolute humidity is found in MIL-HDBK 310, along with data for absolute humidity at altitude. The dew point, the temperature at which condensation would occur if the air was cooled at constant pressure, is the observed meteorological element used to calculate the absolute humidity. Relative humidity is the ratio of the current absolute humidity to the highest possible absolute humidity (which depends on the current air temperature). A reading of 100 percent relative humidity means that the air is totally saturated with water vapor and cannot hold any more. For a given volume of air, with a given absolute humidity, the relative humidity will increase as the temperature decreases until the dew point is reached. At that point the water vapor will condense out as liquid water.

The effects of ambient humidity on materiel depends on the humidity levels, temperature, pressure, and duration of exposure. For long term exposure effects see MIL-STD-810, method 507. The effects of interest in this test method pertain to effects due to condensation and freezing of water vapor when the dew point is reached during materiel operation and also effects due to absorption and intrusion of water within material. Note that the materiel temperature may be lower than the ambient environment due to black body radiation.

When deployed in a Warm/Moist environment, materiel and the materiel enclosures (equipment bays, cockpit, cabins, etc.) will experience the absolute humidity of the ambient environment. Upon transition to a cold environment (aircraft climb to altitude) the water vapor will condense when the temperature drops to the dew point. This may result in liquid water pooling within electronic equipment; with the potential to create short circuits, sneak circuits, and other adverse effects. The water may subsequently freeze. The expansion of water during freezing may damage components, degrade seals, and lead to delamination of material.

Humidity stresses also occur during transition from a Cold/Dry environment to a Warm/Moist environment (aircraft descent from altitude). In this case the materiel temperature transition lags the transition of the ambient environment. Humidity from the Warm/Moist environment will then condense on, and within, the cold surfaces of the materiel. This may result in liquid water pooling within electronic equipment; with the potential to create short circuits, sneak circuits, and other adverse effects. If the materiel surface temperature is below the freeze point the water may subsequently freeze. The expansion of water during freezing may damage components, degrade seals, and lead to delamination of material.

During environmental testing the intent is to simulate the ascent and descent of the aircraft within, and through, the varying atmospheric temperature and humidity levels. During transitions from high altitude /cold to low altitude/warm/moist, the humidity ramp rate shall be sufficient to induce moisture condensation and frost on the test material.

For materiel located within an ECS controlled environment, the efficiency of the water separator will be an important consideration during the test. ECS operation may result in high relative humidity (RH) due to chilling of the air. This will produce condensation if the dew point is exceeded. Characterization and replication of the ECS system is essential in the development and validity of testing materiel in this environment. When the efficiency of the ECS is unknown, use the approximation technique in 2.2.4.1.1 b.

For this test, whenever the cold day environment is being simulated, humidity will be uncontrolled, but less than or equal to the dew point temperature in Annex Table 520.5A-II. For the hot environment, dew point temperatures will be less or equal to values in Annex Table 520.5A-I. For the Warm/Moist day, dew point temperatures will be greater than or equal to the values in Annex Table 520.5A-III up to 10 km (6.2 mi) altitude. Above 10 km (6.2 mi), the dew point temperature is less than or equal to the values in Annex Table 520.5-II. If the platform has an ECS, the design specifications for the Warm/Moist day apply.

2.2.4.4 Electrical Stress.

Electrical stresses are expected deviations of the materiel's electric supply parameters from their nominal values at the materiel terminals. Every aircraft electrical power system is required to be designed to ensure the retention of the electrical characteristics as specified in the selected standard document, throughout the full range of operational and environmental conditions likely to be encountered in the aircraft in which it is installed. (Reference STANAG 3456 Edition 7). The test procedure must simulate to the required extent, all electrical stresses occurring during normal operation in service (mission profile) that contribute synergistically to the environments. In addition, appropriately demonstrate operation of the test materiel's functions at each test condition. It is not the purpose of this test to simulate

MIL-STD-810H
METHOD 520.5

extremes specified for special situations or to take the place of electrical stress tests. Simulate special conditions such as emergency operation of certain aircraft materiel within the electrical/electronic system only on request. Depending upon the requirements and the availability of data, the simulation may cover the range from the exact reproduction of the specific electric supply conditions within a special aircraft for a specific mission profile, down to a standardized simplified profile for generalized applications.

A significant percentage of the materiel life cycle occurs during maintenance operations, which may use ground power from ground support equipment. Ground support equipment normally replicates platform power, but input power measurements may be necessary if the equipment is sensitive to input power anomalies.

Consider the following conditions and effects to determine whether they affect the operation and reliability of the materiel to be tested. See Part One, Section 5.1.c, Test Conditions, Input Power for guidance to available sources of voltage and frequency characteristics or Tables 520.5-IV, 520.5-V and 520.5-VI that contain steady state voltage and frequency conditions.

- a. AC system normal operation stresses.
- b. Normal ON/OFF cycling of materiel operation.
- c. DC system normal operation stresses.
- d. Electrical stresses induced by mission-related transients within the electrical system.
- e. Abnormal steady state stresses of voltage and frequency if the material is required to operate for safety of the mission or personnel.
- f. Emergency steady state stresses of voltage and frequency if the material is required to operate for safety of platform or personnel (flight critical).

2.2.4.4.1 AC & DC System Normal Operation Stresses.

Voltage variations are quasi-steady changes in voltage from test cycle to test cycle. A suggested input voltage schedule would be to apply the input voltage at platform nominal voltage for the first test cycle, at the platform high normal voltage for the second test cycle, and at platform low normal voltage for the third test cycle. This cycling procedure would be repeated continuously throughout the test, with the last cycle performed at the nominal voltage. However, if troubleshooting, then use the power characteristics at which the failure or anomaly occurred, along with the other environmental conditions at the time of the anomaly.

For AC systems, the input electrical power frequency variations shall also be considered when developing the test cycle. The input power frequency will vary during normal operation due to variations in the generator RPM and platform power loads. The frequency variations may result in increased thermal loads leading to equipment failures or abnormal operation of equipment. Some failures, such as the failure of EMI filters, may not be obvious. This should be considered in developing the overall test development schedule.

See Tables 520.5-IV, 520.5-V and 520.5-VI for normal input power parameters. Additional data may be found in MIL-STD-704, RTCA-DO160, and MIL-STD-1275. For shipboard power refer to MIL-STD-1399, Part 300.

A suggested input voltage and frequency variation schedule is provided in Table 520.5-III.

Table 520.5-III: Input Voltage and Frequency Test Schedule

Cycle	Normal Operating Voltages	Frequency (AC systems)
1	Nominal	Nominal
2	High	Low
3	Low	High
4	Nominal	Nominal
5	High	High
6	Low	Low
7	Nominal	Nominal
8	High	High
9	Low	Low
10	Nominal	Nominal

MIL-STD-810H
METHOD 520.5

Table 520.5-IV: Aircraft Electrical Power Characteristics

Department of Defense MIL-STD-704 Aircraft Electrical Power Characteristics							
MIL-STD-704 Version	MIL-STD-704	MIL-STD-704A	MIL-STD-704B	MIL-STD-704C	MIL-STD-704D	MIL-STD-704E	MIL-STD-704F
Published Date	6-Oct-59	9-Aug-66	17-Nov-75	30-Dec-77	30-Nov-80	1-May-91	12-Mar-04
115 Line to Neutral (rms) 400 Hz							
Normal AEOC	Normal Aircraft Electrical Operating Condition						
Voltage Steady State Limit (Vrms)	107.5-119.5	108-118	108-118	108-118	108-118	108-118	108-118
Frequency Steady State	380-420	380-420	395-405	393-407	393-407	393-407	393-407
Abnormal AEOC	Abnormal Aircraft Electrical Operating Condition						
Voltage Steady State Limit (Vrms)	103-137	102-124	100-125	100-125	100-125	100-125	100-125
Frequency Steady State	320-480	370-430	375-425	380-420	375-425	380-420	380-420
Emergency AEOC	Emergency Aircraft Electrical Operating Condition						
Voltage Steady State Limit	105-122	104-122	102-124	104-122	104-122	108-118	108-118
Frequency Steady State	360-440	360-440	360-440	360-440	360-440***	393-407	393-407
28 VDC (mean)							
Normal AEOC	Normal Aircraft Electrical Operating Condition						
Voltage Steady State(Norm)	21-29	24-28.5	22-29	22-29	22-29	22-29	22-29
Ripple(1.2kHz-16.8kHz)	1.5	2.0 Peak/Mean	1.5 Peak/Avg	1.5 Peak/Avg	1.5 Peak/Avg	1.5 Peak/Avg	1.5 Peak/Avg
Abnormal AEOC	Abnormal Aircraft Electrical Operating Condition						
Voltage Steady State(Abn)	12-36	22.5-30	20-31.5	20-31.5	20-31.5	20-31.5	20-31.5
Emergency AEOC	Emergency Aircraft Electrical Operating Condition						
Voltage Steady State(Eng)	17-29	16-24	18-29	16-30	16-29	18-29	16-29
270 VDC (mean)							
Normal AEOC	Normal Aircraft Electrical Operating Condition						
Voltage Steady State(Norm)			250-280	250-280	250-280	250-280	250-280
Ripple(1.2kHz-16.8kHz)			6.0 V Peak/Avg	6.0 V Peak/Avg	6.0 V Peak/Avg	6.0 V Peak/Avg	6.0 V Peak/Avg
Abnormal AEOC	Abnormal Aircraft Electrical Operating Condition						
Voltage Steady State(Abn)			245-285	245-285	245-285	240-290	240-290
Emergency AEOC	Emergency Aircraft Electrical Operating Condition						
Voltage Steady State(Eng)			240-290	240-290	240-290	250-280	250-280
MIL-STD-704 Version Aircraft Platforms							
	C-2	E-3	None	AV-8	UH-1Y/AH-1Z	F-18 E/F/G	CH-53K
	C-9	E-2		E-6A	V-22	P-8	AH-64E
	C-5	F-18 A/B, C/D		OH-58D	AH-64D	F-35	MQ-8C
		P-3		C-17		MH-60M (VDC)	MQ-25
		H-3				UH-60M/V (VDC)	YMQ-18A
		H-53D/E				MQ-8B	PAR
		H-60				MQ-4C	
		EA-6B				MQ-1C	
		UH-1N/AH-1W				RQ-7B	
		MH-47D/G				CRH (VDC)	
		CH-47E/F				A-29	
		AH-64A				RQ-4	
		UH, HH-60A/L					
		MH-60M (VAC)					
		UH-60M/V (VAC)					
		F-15					
		F-16					
		CRH (VAC)					

Note 1. Refer to MIL-STD-704 for additional information concerning electrical power characteristics.

Note 2. The MIL-STD-704 version may have additional notices. Refer to the latest notice to find any changes. Most notices do not vary the input power steady state conditions.

Note 3. ***360 – 457 Hz (V-22) Special Frequency Range, see V-22 platform specification.

Note 4. If material is to be used on multiple platforms, use the lowest and highest levels of all applicable MIL-STD-704 versions.

Note 5. Refer to STANAG 3456, ISO 1540, or EN 2282 for NATO member aircraft electrical power characteristics.

Note 6. For the C-130, F-22, and U-2 aircraft platforms, contact the appropriate Platform Program Office for electrical power conditions.

MIL-STD-810H
METHOD 520.5**Table 520.5-V. Ground Vehicle 28 VDC Characteristics**

Department of Defense MIL-STD-1275 Military Ground Vehicles 28Volt DC Characteristics					
MIL-STD-1275 Version	MIL-STD-1275A	MIL-STD-1275B	MIL-STD-1275C	MIL-STD-1275D	MIL-STD-1275E
Published Date	17-September-1996	20-November-1997	23-June-2006	29-August-2006	22-March-2013
28 VDC mean					
Normal Range Voltage	23-33, Change Notice 2	25-30	25-30	25-30	20-33
Ripple Voltage	2V pk to pk(50Hz to 200KHz)	2V pk to pk(50Hz to 200KHz)	2V pk to pk(50Hz to 200KHz)	2V pk to pk(50Hz to 200KHz)	MIL-STD-461, CS101 limits, 30Hz to 250KHz, Figure CS101-1
Initial Engagement Surge Voltage	6 for 1 second	6 for 1 second	6 for 1 second	6 for 1 second	12 for 1second
Cranking Surge Voltages	16 for 30 seconds	16 for 30 seconds	16 for 30 seconds	16 for 30 seconds	16 for 30 seconds

Note 1: Refer to MIL-STD-1275 for further information concerning electrical DC power characteristics.

Table 520.5-VI. RTCA DO-160 Power Characteristics

Commercial Standard RTCA DO-160 Power Input Characteristics			
RTCA-DO-160 Version	DO-160E	DO-160F	DO-160G
Published Date	09-December-2004	06-December-2007	08-December-2010
115 Line to Neutral (rms) 400Hz			
Normal Voltage Steady State	100-122	100-122	100-122
Frequency Steady State	390-410	390-410	390-410
Abnormal Voltage Steady State	97-134	97-134	97-134
Abnormal Frequency Steady State	370-430	370-430	370-430
28 VDC mean			
Normal Voltage Steady State	22-30.3	22-30.3	22-30.3
Normal Ripple Voltage	≤4V pk to pk	≤4V pk to pk	≤4V pk to pk
Abnormal Voltage Steady State	20.5-32.2	20.5-32.2	20.5-32.2
Emergency Voltage	18	18	18
270 VDC mean			
Normal Voltage Steady State	N/A	235-285	235-285
Ripple Voltage	N/A	≤16 pk to pk	≤16 pk to pk
Emergency Voltage	N/A	235	235

Note 1: Refer to DO-160, Section 16.0 for further information concerning electrical power characteristics.

MIL-STD-810H
METHOD 520.5**2.2.4.4.2 Normal ON/OFF Cycling of Materiel Operation.**

Turn the materiel on and off in accordance with materiel operating procedures outlined in appropriate technical manuals, to simulate normal use.

2.2.4.5 Vibration Stress.

Method 514 contains guidance for characterizing the vibration environment through measured data and laboratory vibration specification development, with Operational Tailoring Guidance provided in Annex D. Default vibration profiles are provide in Method 514, Annex D, for use when measured data are unavailable. Caution should be used when applying the default vibration profiles in Method 514 for functional tests since the default profiles often contain significant time compression and conservatism. As a result, the default vibration levels may not be representative of the functional vibration environment. When the time compression factors are known, adjustments to the default profiles may be made by removing the time compression factor using the Miner-Palmgren Equations (i.e., Miner's Rule) discussed in Method 514, Annex F, paragraph 9.2.1. The resulting levels will typically be more representative of the maximum service levels for use in the functional vibration test. Reference Method 514, Annex A, paragraph 2.1.2.1.

Note that conservatism factors in the Method 514 default vibration profiles are imposed for various reasons (see Method 514, paragraph 2.1b) that are applicable to the functional vibration test. Thus conservatism factors should not be removed from the default vibration profiles without careful consideration.

For Procedure I the vibration levels shall replicate the materiel design/specification levels. For Procedure II the vibration levels shall be based on a particular mission profile. For Procedure III the vibration levels shall be based on the maximum performance envelope of the aircraft.

- a. The vibration stresses to be considered for the test cycle are those due to both attached and separated aerodynamic airflow along the vehicle's external surfaces, jet engine noise, or pressure pulses from propeller or helicopter blades on the aircraft structure. Determine the vibration spectrum and level for each mission segment by careful use of measured data. Apply the guidance written below in those cases.
- b. In many instances, field/fleet flight data are not available for the specific aircraft, materiel location in the aircraft, or flight phases. In such cases, there are several analytical techniques for vibration, spectrum, and level prediction that can be used to determine vibration test conditions (see Method 514 and Table 520.5-VII).
 - (1) Scaling vibration test conditions from data obtained on another platform at a different materiel location, or for a different flight condition has to be done with extreme care because of the numerous nonlinear relationships involved and the limited amount of data being used. For example, maneuver-induced vibration conditions generally cannot be predicted from cruise vibration data. A more prudent approach is to use the linear dynamic pressure models in Method 514.
 - (2) In all cases, field/fleet flight vibration data should be defined in accordance with Method 514 following the vibration characterization guidance in paragraph 2.3.
- c. Because of the nature of vibration control equipment, it may be difficult to change vibration level and spectrum shape in a continuous, smooth manner. Therefore, the mission profile may be divided into segments over which it will be assumed that the vibration level and spectrum shape is constant for test purposes. In addition, vibration specifications are typically defined in three orthogonal axes and the vibration tests are typically conducted in three sequential axis vibration tests, unless a multi-axis test apparatus is available. Ideally, each segment of the mission profile should be divided by the three axes of vibration. However, in a combined environment, changing test axes in the middle of a segment of a mission profile may be impractical and may invalidate the test results. In this case, it may be necessary to perform the functional vibration only in the worst case axis in terms of vibration level and materiel sensitivity. Alternatively, different axes may be tested in different phases of the test cycle.
- d. Unless field/fleet data exist, the appropriate tables and figures of Method 514, Annex D, are used to determine vibration conditions except as modified in Table 520.5-VII.

MIL-STD-810H
METHOD 520.5**Table 520.5-VII. Default Functional Vibration Test Criteria.**

Aircraft Type	Default Vibration Profiles	Notes Regarding Default Vibration Profiles
Fixed Wing Jet Aircraft	Method 514, Table 514.8 D-I	As stated in Method 514, Annex D, default vibration profiles for fixed wing jet aircraft are based on empirical data and time compression information is unknown. The vibration profile should be computed for each segment of the mission profile. Functional vibration tests should be conducted at the amplitudes computed from Table 514.8–D-I for sufficient time to fully verify equipment functionality.
Fixed Wing Propeller Aircraft	Method 514, Tables 514.8 D-II	As stated in Method 514, Annex D, Paragraph 2.2d, default functional test vibration levels for fixed wing propeller aircraft can be derived by scaling the endurance ASD levels described in Table 514.8D-II.
Helicopters	Method 514, Tables 514.8D-III	As stated in Method 514, Annex D, Paragraph 2.3e(4), default functional test vibration levels for helicopters can be derived by scaling the endurance levels described in Table 514.8D-III.

- e. If it is determined that the synergistic effects of vibration/altitude or vibration/humidity have little or no impact on the performance of the materiel, vibration may be applied combined with temperature as part of vibration testing (Method 514), with temperature, altitude, and humidity environments combined separately.
- i. Short duration vibration or shock events and those that occur infrequently in the test cycle should be considered in addition to steady state vibration described in Method 514. If the synergistic effects of these events with altitude or humidity are determined to have significant impact on the performance of the materiel. Typical transient events on fixed and rotary wing aircraft may include firing of on-board guns, opening of bomb-bay doors, launcher ejection, adjacent missile launches, and shock due to hard landings. If the synergistic effects of these events are not significant, test for these events separately, or combined with temperature, using the appropriate test method within this Standard.
- j. For those segments with similar vibration spectrum shape, use the following analysis to reduce the number of vibration test levels. The discussion is in terms of the suggested spectrum shapes for jet, rotary wing, or propeller aircraft of Method 514.
 - (1) Determine the vibration level, W_o (g^2/Hz), for each mission segment using the altitude and Mach number plots for each mission.

NOTE: For test purposes, the larger W_o due to aerodynamic forces or W_o due to jet engine noise, etc., is used at any point in time in the mission. Identify the maximum W_o value that occurs in each mission.

- (2) Consider all segments of the mission that have w_o values within three dB of maximum, as having a constant W_o value of W_{oMAX} . Consider all segments of the mission that have values between W_{oMAX} -3dB and W_{oMAX} -6dB as having a constant W_o value of W_{oMAX} -4.5dB. This process of identifying three-dB bands of dynamic vibration values, over which W_o is considered to be a constant and whose value is determined by using the dynamic vibration value of the band's midpoint, is continued until the calculated W_o value is less than $0.001g^2/Hz$. For test purposes, segments of the mission with calculated values of W_o less than $0.001g^2/Hz$ can be set equal to 0.001. Each segment has a respective time in mission

MIL-STD-810H
METHOD 520.5

associated with it that is added together creating a T(MAX), T(-4.5), etc. Vibration is then applied for their respective times during the test. A single vibration level may be created using the test acceleration formula of Method 514, Annex A, paragraph 2.2, but the synergistic effects in combination with temperature may be misapplied.

2.3 Determine Test Levels and Conditions.

Having selected this Method (see paragraph 2.1), and relevant procedures (see paragraph 2.2), and based on the test item's requirements documents and the tailoring process, complete the tailoring process by identifying appropriate parameter levels and special test conditions and techniques for these procedures. Base selections on the requirements documents, the LCEP, and information provided with this procedure.

This section provides the guidance to determine the materiel functions and the combined environments in which the materiel is designed to be employed, such as temperature, cooling airflow, altitude, humidity, input electrical power, vibration, rates of change, and stress durations.

Use Table 520.5-VIII referenced throughout this paragraph, to develop a test schedule. Specific guidance for the individual stresses are found in paragraph 2.2.4.

2.3.1 Test Cycle Development.

A test cycle is defined in this method as a series of test segments simulating different climatic/dynamic/power input conditions. In general, a test cycle is composed of separate temperate/altitude/humidity segments: cold/dry, cold/dry/altitude, warm/moist, hot/dry, hot/dry/altitude, etc. Additional test parameters (power, vibration, supplemental cooling air, etc.) are incorporated as required to simulate the operational environment. For engineering development (Proc. I) and platform envelope (Proc. III) testing, the profile is defined as a set of life cycle conditions encompassing the materiel design/specification requirements and arranged to encompass all expected combinations of potential mission environments (Figures 520.5-3a, 520.5-3b and Table 520.5-VIII). For mission specific testing, a profile is defined as a performance-environmental condition-time history of the specific mission of concern. A specific mission profile (Proc. II) may be divided into segments such as takeoff, cruise, combat, maneuvering, landing, maintenance, etc., with each segment replicating the climatic/dynamic/power input conditions representative of that mission segment (Figure 520.5-2).

When performing Procedures I or III, the test parameters are derived from the platform/equipment performance specifications, and design documentation. Using the maximum design parameters, compile a table of the climatic and induced environments, and the combination of those environments that the equipment will be subjected to during its life cycle. Develop a test cycle that simulates each of the appropriate combined environments derived from the LCEP. Each segment of the profile should be of sufficient duration for the environmental stresses to stabilize, and to allow for performance verification.

When performing Procedure II, the test parameters are derived from the specific mission parameters as per the portion of the LCEP that defines this specific mission. Use of measured platform data, if available, from the specific equipment location is essential. If measured data is not available, parameter data may be obtained from the program management office, user needs statement, etc. Identify the specific climate(s) under which the equipment is intended to operate; hot/humid (tropical), hot/dry (desert), cold/dry (desert), cold (arctic), etc. Determine the specific environmental conditions, and combinations of conditions, to which the material will be exposed during performance of the mission. This includes both climatic environments (temperature, altitude, humidity) and induced environments (vibration, power, supplemental cooling). Using this data develop a mission profile inclusive of taxiing, take-off, cruise, combat, maneuvering, landing, maintenance, etc.

When Procedure II is to be used for troubleshooting, then the test parameters are derived from the specific mission conditions under which the equipment experienced a failure. This shall include performance data and measured climatic/dynamic/power data obtained during the timeframe of the failure, to the extent that the relevant data is available. Anomalies experienced during flight operations may be specific to the environmental and dynamic conditions at the time of the anomaly. The anomaly may not manifest itself upon return to ambient conditions. Due to the cumulative and synergistic effects of the various environments, the full mission profile is recommended for initial troubleshooting. As troubleshooting progresses, specific segments of the profile may be exercised to isolate and define the root cause of failure.

Refer to Table 520.5-VIII for guidance on test parameter selection. Reference the LCEP.

MIL-STD-810H
METHOD 520.5**Table 520.5-VIII: Test Parameter Selection/Profile Development**

Procedure			Step	Task
I	II	III		
X	X	X	Step 1	Identify the platform(s), the test materiel installation location(s), and geographical deployment location(s).
X		X	Step 2	Identify the platform(s)/materiel specification requirements. Specification requirements should encompass all planned mission requirements.
	X		Step 2a	Identify the specific mission scenario(s).
X		X	Step 3	Identify applicable individual forcing functions (temperature, altitude, humidity, input electrical power, functional vibration , etc.) (Exception: short term and transient events, e.g., gunfire, crash shock, etc.)
	X		Step 3a	Identify the specific mission forcing functions that support the mission profile. (including climatic, dynamic, and electrical functions)
X	X	X	Step 4	Identify operational requirements of the equipment, including duty cycle, transients, and operational modes (to include all anticipated mission operational scenarios)
X	X	X	Step 5	Identify the temperature, altitude, humidity, input electrical power, and functional vibration levels for each segment of the test profile. See para 2.2.4 and sub paragraphs.
X	X	X	Step 6	Identify the type of cooling (RAM/ECS/convective) and cooling environment for the test item for each segment (see paragraph 2.2.4.1 and 2.2.4.1.1).
X	X	X	Step 7	Develop a table listing all the applicable forcing functions/levels and operational requirements identified in the above steps for each mission or platform.
X		X	Step 8	Identify the applicable combinations of climatic/dynamic/ power parameters considering the full range of platform requirements, as derived from the LCEP. This should include all anticipated combinations of thermal/altitude/humidity/vibration environment and the associated operational/power requirements for each segment of the test profile. For high performance aircraft the Mach/altitude effects shall be considered.
	X		Step 8a	Identify the thermal/altitude/humidity/vibration environment combinations and the associated operational/power requirements for each mission segment (start, idle, taxi, take off, climb, cruise, loiter, combat, maneuver, descent landing).
X		X	Step 9	Using the data identified in steps 1 through 8, develop a representative composite table/profile for thermal, altitude, humidity, functional vibration, test item cooling, and operational power for the most severe expected environments. (see Table 520.5-IX and Figures 520.5-3a and 520.3b)
	X		Step 9a	Using the data identified in steps 1 through 8, develop a thermal, altitude, humidity, functional vibration, test item cooling and operational power profile.

MIL-STD-810H
METHOD 520.5**2.4 Test Item Configuration.**

See Part One, paragraph 5.8.

3. INFORMATION REQUIRED.**3.1 Pretest.**

The following information is required to perform a combined environments test adequately.

- a. General. Information in Part One, paragraphs 5.7, 5.9, and 5.12; and in Part One, Annex A, Task 405 of this Standard.
- b. Specific to this Method.
 - (1) Purpose of the test, e.g., engineering development, flight or operation support, platform envelope verification, etc.
 - (2) LCEP defining the combination of three or more of the following environments: temperature, altitude, humidity, input electrical power, and vibration to be applied simultaneously.
 - (3) Test item platform envelope and/or mission profile(s).
 - (4) Test item installed location within the respective platform and any specifics associated with the installed location (to include power, cooling, fixturing, etc.)
 - (5) Climatic/Dynamic Sensor Locations: Mapping of control and response sensors' locations in relation to the test item and test chamber.
 - (6) Data acquisition rate: The data sampling rate shall be set to accurately record all test parameter transitions. Sample rates shall be sufficient to verify parameter tolerances and change rates.
- c. Tailoring. The test profile shall be tailored to simulate the LCEP requirements to the greatest extent possible within facility limitations.

3.2 During Test.

- a. General. See Part One, paragraphs 5.10 and 5.12; and information in Part One, Annex A, Tasks 405 and 406 of this Standard.
- b. Specific to this Method.
 - (1) Complete record of temperature, altitude, humidity, input electrical power, and vibration levels correlated to test profile sequence. The test data sample rate shall be sufficient to demonstrate that all ramp rate requirements (Temperature, Altitude, etc.) have been met.
 - (2) Complete record of materiel function correlated with test profile sequence.

3.3 Post-Test.

The following post-test data shall be included in the test report to.

- a. General. Information listed in Part One, paragraph 5.13; and in Part One, Annex A, Task 406 of this Standard.
- b. Specific to this Method.
 - (1) Previous test methods to which the specific test item has been subjected.
 - (2) Any deviations from the original test plan.
 - (3) Environmental parameter versus time data plots (temperature, altitude, humidity, input electrical power, and vibration). Sufficient detail is required to verify that all test parameters are met, including temperature and altitude ramp rates, etc.
 - (4) Out of tolerance conditions, test interruptions, data gaps, etc. shall be annotated and fully described.
 - (5) Document any modifications/interruptions to the test profile sequence. Refer to the paragraphs 4.4 and 5.0 for analysis of any effects due to the profile changes.

MIL-STD-810H
METHOD 520.5

- (6) Functional Test Data, including Pass/Fail criteria.
- (7) Operator Test Logs.
- (8) Pre, During, and Post Photos of test item and any observed anomalies.

4. TEST PROCESS.

4.1 Test Facility.

Use a facility that can provide the required combination of three or more environmental elements. Verify that the facility is capable of meeting all test parameters; to include specified temperature and altitude ramp rates. See the guidance for the facilities for the individual element tests, i.e., latest revision of Methods 500, 501, 502, 507, and 514. Ensure the facility satisfies the requirements of Part One, paragraph 5.

4.1.1 Power Supplies.

Use power supplies which have sufficient power capacity to account for start-up and operational current surges. At minimum, the power supply should be able to replicate the voltage and frequency characteristic of the platform (s) for Alternating Current sources or the voltage for Direct Current sources. The electrical characteristics are defined at the input terminals. It is highly recommended that the input electrical power characteristics be measured at the input terminals of the equipment under test (see MIL-HDBK-704, section 4, general information). If power characteristics, such as transients or interrupts, are required, use programmable power supplies as necessary.

4.2 Controls / Tolerances.

Ensure calibration procedures are consistent with the guidance provided in Part One 5.3.2. Ensure test tolerance procedures are consistent with the guidance provided in Method 514 Paragraph 4.2.2

4.3 Test Interruption.

Test interruptions can result from two or more situations, one being from failure or malfunction of test chambers or associated test laboratory equipment. The second type of test interruption results from failure or malfunction of the test item itself during functional tests.

4.3.1 Interruption Due To Facility Malfunction.

- a. General. See Part One, paragraph 5.11 of this Standard.
- b. Specific to this Method.
 - (1) Undertest interruption. Refer to the interruption guidance for the individual test elements, i.e., temperature, altitude, humidity, input electrical power, and vibration.
 - (2) Overtest interruption. Refer to the interruption guidance for the individual test elements, i.e., temperature, altitude, humidity, input electrical power, and vibration.
 - (3) In the case of failure of the Data Acquisition (DAQ) system (while the facilities are still working properly), take into account possible safety issues, if anything important may have been missed in the output/response of the materiel, and how much of the time DAQ was down. The test may be continued without any changes if there are no concerns, or may have temporary interruption just to get DAQ working again. If there are any concerns take the appropriate action based on the test interruption information in this Method as well as in Part One, paragraph 5.11 of this Standard.

4.3.2 Interruption Due To Test Item Operation Failure.

Failure of the test item(s) to function as required during functional tests presents a situation with several possible options. Prior to restarting the test the root cause of the failure shall be determined, along with the remedial action. This determination will aid in determining which of the following options is preferred. The failure analysis shall be included in the test report. (See section 5 for additional guidance.)

- a. The preferable option is to replace the test item with a “new” one and restart from Step 1.
- b. A second option is to replace/repair the failed or non-functioning component or assembly with one that functions as intended, and restart the entire test from Step 1.

MIL-STD-810H
METHOD 520.5

- c. For non-relevant anomalies, which do not affect the functionality of the unit under test, following a review of the data, the test may be resumed at the start of the cycle.

NOTE: Test item failures may be the result of cumulative environmental stresses, including stresses from prior tests on the test item. When evaluating failure interruptions, evaluate prior testing on the same test item and consequences of such. This may necessitate the repetition of prior tests to validate the corrective action.

4.3.3 Scheduled Interruptions.

There are situations in which scheduled test interruptions will take place. These interruptions shall be approved by the cognizant organization and documented in the test plan and/or the test report. Interruptions shall be scheduled so as to have the least impact on the test conditions. Preferably these interruptions shall occur during steady state environmental conditions or at the end of a cycle. Following the interruption, all test parameters, for both the test chamber and test item, shall be stabilized at the values immediately preceding the interruption. See also Part One paragraph 5.11.4. Scheduled interruptions may result from the following:

- a. Test Item Life Cycle Event: This would include the replacement of batteries or consumables, required reorientation of the test item during the test, etc. It also includes material operation which cannot be performed remotely. (Note: when possible, material operation shall be performed remotely via pneumatic/electrical actuators or by other means which do not compromise the test environment.
- b. Test Chamber/Support Equipment Events: These may include scheduled maintenance such as the periodic calibration of sensors, reconfiguration for alternate modes of operation, re-torquing of fixtures, etc. Foreseen inclement weather may necessitate a test suspension and/or controlled shutdown due to the potential for power interruption and/or personnel limitations.
- c. Personnel events: It is preferred that testing be performed on a 24/7 work schedule. When this is not feasible, then the test shall be interrupted at the end of the cycle. The test chamber shall be maintained at standard ambient conditions during the interruption. Interruption of the test at other points of the test profile shall require approval from the cognizant organization.

4.4 Test Execution.

The following steps, alone or in combination, provide the basis for collecting necessary information concerning the test item in a combined environment of temperature, altitude, humidity, input electrical power, and vibration. Begin with the first procedure specified in the test plan.

4.4.1 Preparation For Test.

4.4.1.1 Preliminary Steps.

Before starting the test, review pretest information in the currently approved test plan to determine test details (e.g., procedures, item configuration, cycles, durations, parameter levels for storage/operation, etc.). (See paragraph 3.1, above.)

4.4.1.2 Pretest Standard Ambient Checkout.

All test items require a pretest standard ambient checkout to provide baseline data. Conduct the checkout as follows:

- Step 1: Conduct a visual examination of the test item with special attention to stress areas, such as corners of molded cases, and document the results.
- Step 2: Install the materiel in the test chamber in its operational configuration. Verify all electrical and mechanical connections.
- Step 3: In order to determine thermal response install temperature sensors in or on the test item as described in the test plan.
- Step 4: Install any additional sensors and ancillary equipment as required by the test plan.
- Step 5: Conduct a test of the data acquisition system and verify all data is being recorded.

MIL-STD-810H
METHOD 520.5

Step 6: Conduct a functional test (Part One, paragraph 5.8.2) at standard ambient conditions (Part One, paragraph 5.1) as described in the plan and record the results.

Step 7: If the test item operates satisfactorily, proceed to paragraph 4.4.2, 4.4.3, or 4.4.4 as appropriate. If not, resolve the problems and repeat Step 5 thru 6 above. If resolution requires replacement of the item, or removal, of sensors in order to repair, then repeat Steps 1 through 6 above.

4.4.2 Procedure I – Engineering Development.

Procedure I may be used during engineering development to establish design margins and verify that the design meets its engineering requirements during exposure to the specified environments. Test profile development shall follow the guidance shown in table 520.5-VIII. Test parameters should be chosen based on the intent of the engineering test. Although based on the design specification, more extreme parameters may be preferred to establish design margins. Refer to Procedure III for an example of a platform envelope. For specific engineering tests, based on suspected failure modes, a specific segment of the profile may be conducted that incorporates test parameters more extreme than the specification requirement.

4.4.3 Procedure II – Flight or Mission Support.

The Procedure II test profile is intended to simulate the climatic, dynamic, input electrical power, and operational events experienced in specific missions or troubleshooting scenarios. These missions represent specific geophysical areas of operation and do not cover the full platform envelope. No one profile is appropriate for use, rather separate profiles must be developed to cover the specific mission/troubleshooting scenario. The following paragraphs discuss representative mission segments. These segments may be combined, along with the appropriate transition parameters, to develop the mission profile. Some segments, such as cruise and attack, may be repeated at different portions of the profile and at different levels. All segments may, or may not, be required for specific missions/troubleshooting. These segments are not all encompassing and additional segments may be required.

Measured data is essential for each of these parameters to actually replicate the exact conditions for this segment. Test parameters are to be based on measured data to the greatest extent possible. These include the geophysical climatic data, specific environmental conditions of the equipment installation, dynamic response of the platform, and input power quality. When measured data is not available, MIL-HDBK-310 may be referenced for atmospheric data.

For each segment the forcing functions described below shall be evaluated in developing the profile. The maintenance and non-op segments may represent platform non-operational periods; or may represent materiel which is not installed on the platform and is either in the logistics supply chain (storage) or undergoing maintenance in a repair facility. The duration for each segment shall be determined by the mission scenario. This list is not all inclusive; additional forcing functions may be required for specific missions. The following mission segments are generally ordered for a representative mission. This order may vary depending on the specific mission.

4.4.3.1 Non-Operational/ Ground Soak.

Measured data is essential for each of these parameters to actually replicate the exact conditions for this segment.

- a. Temperature: Determine the deployment location and any induced temperatures based on the materiel installation (solar loading, heating from adjacent material, etc.) (Stabilize to the mission ground soak temperature; day or night mission.) See Section 2.2.4.1 (Thermal Stress).
- b. Altitude: Site altitude of the deployment location. See Section 2.2.4.2 (Altitude Stress)
- c. Humidity: Measured humidity at the deployment location. See Section 2.2.4.3 (Humidity Stress).

4.4.3.2 Start Up/Taxi.

- a. Temperature: Ground soak temperature based on equipment location. (Note: Some materiel may receive conditioned air prior to start up.) Use measured data or thermal survey data. See Section 2.2.4.1 (Thermal Stress) and Section 2.2.4.1.1 (Bay Conditions).
- b. Altitude: Site altitude of the deployment location. See Section 2.2.4.2 (Altitude Stress)
- c. Humidity: Measured humidity at the deployment location. See Section 2.2.4.3 (Humidity Stress).

MIL-STD-810H
METHOD 520.5

- d. Input Electrical Power: Use measured data or data from the electrical loads analysis, including power transfer interrupts during transfer from ground to aircraft power. (If trouble shooting, consider the effects of power transients. Attempt to replicate aircraft power.) See Section 2.2.4.4 (Electrical Stress).
- e. Supplemental Cooling: If required, the supplemental cooling shall meet the temperature and mass flow rates for the specific platform ECS system. For ECS systems open to the external environment, the mass flow rate to the LRU shall be adjusted for the pressure altitude. See Section 2.2.4.1 (Thermal Stress). It is imperative that the cooling system design be understood in order to properly replicate during test!
- f. Vibration: Vibration levels shall be based on the functional vibration levels for the specific materiel location and the specific mission segment under test. Vibration levels may vary throughout the test. See section 2.2.4.5 (Vibration Stress) and Method 514, annex A, paragraph 2.1.2.1 (Functional Vibration Definition).

4.4.3.3 Climb to Cruise/Surveillance.

- a. Temperature: Ramp the temperature from the ground/site temperature to the High Altitude/Cruise Temperature for the specific geophysical location. For external materiel use measured data or the appropriate atmospheric lapse rate (dry/humid) for the mission geophysical location. For internal materiel use measured data or thermal analysis/survey data Section 2.2.4.1.1 (Bay Conditions). For materiel designed for specific geophysical locations, if measured data is not available use data from MIL-HDBK-310. See Section 2.2.4.1 (Thermal Stress). The ramp rate shall be IAW the platform performance.
- b. Altitude: Ramp the altitude from the ground/site altitude to the High Cruise altitude. For pressurized compartments perform the ramp to the specified pressure altitude. The ramp rate shall be IAW the platform performance. See Section 2.2.4.2 (Altitude Stress).
- c. Humidity: Humidity shall be based on anticipated mission cruise altitude. (Note: For low level missions the humidity will essentially be the same as ground level.) See Section 2.2.4.3 (Humidity Stress).
- d. Input Electrical Power: Use measured data or data from the electrical loads analysis for Climb. (If trouble shooting, consider the effects of power transients. Attempt to replicate aircraft power.) See Section 2.2.4.4 (Electrical Stress).
- e. Supplemental Cooling: If required, the supplemental cooling shall meet the temperature and mass flow rates for the specific platform ECS system. For ECS systems open to the external environment, the mass flow rate to the LRU shall be adjusted for the pressure altitude. See Section 2.2.4.1 (Thermal Stress). It is imperative that the cooling system design be understood in order to properly replicate during test!
- f. Vibration: Vibration levels shall be based on the functional vibration levels for the specific materiel location and the specific mission segment under test. Vibration levels may vary throughout the test. See section 2.2.4.5 (Vibration Stress) and Method 514, annex A, paragraph 2.1.2.1 (Functional Vibration Definition).

4.4.3.4 Cruise/Surveillance.

- a. Temperature: Maintain the cruise/surveillance temperature until the materiel has stabilized or for the duration of the platform cruise/surveillance mission. For long duration surveillance missions, such as UAS missions, a soak of 4 hours following stabilization is generally sufficient. This data may be available from the program office. See Section 2.2.4.1 (Thermal Stress).
- b. Altitude: Maintain the cruise/surveillance altitude until the materiel has thermally stabilized or for the duration of the platform cruise mission. This data may be available from the program office. See Section 2.2.4.2 (Altitude Stress).
- c. Humidity: For low level cruise, the humidity will track the ground level measured humidity for the geophysical location. For high level cruise the humidity will be uncontrolled. See Section 2.2.4.3 (Humidity Stress).
- d. Input Electrical Power: Use measured data or data from the electrical loads analysis for cruise. (If trouble shooting, consider the effects of power transients. Attempt to replicate aircraft power.) See Section 2.2.4.4 (Electrical Stress).
- e. Supplemental Cooling: If required, the supplemental cooling shall meet the temperature and mass flow rates for the specific platform ECS system. For ECS systems open to the external environment, the mass flow rate

MIL-STD-810H
METHOD 520.5

to the LRU shall be adjusted for the pressure altitude. See Section 2.2.4.1 (Thermal Stress). It is imperative that the cooling system design be understood in order to properly replicate during test!

- f. Vibration: Vibration levels shall be based on the functional vibration levels for the specific materiel location and the specific mission segment under test. Vibration levels may vary throughout the test. See section 2.2.4.5 (Vibration Stress) and Method 514, annex A, paragraph 2.1.2.1 (Functional Vibration Definition).

4.4.3.5 Attack.

- a. Temperature: The temperature levels in this segment will vary depending on the type of attack mission: low level ground attack, high altitude air to air, etc. External equipment may experience rapid temperature changes as the platform traverses different thermal layers of the atmosphere. Internal equipment temperatures are expected to remain relatively constant. See Section 2.2.4.1 (Thermal Stress).
- b. Altitude: The altitude may vary rapidly, up to the maximum platform specification rate. During a mission, multiple attack scenarios/events may occur. See Section 2.2.4.2 (Altitude Stress).
- c. Humidity: For low level attack, the humidity will track the ground level measured humidity for the geophysical location. For high level attack the humidity will be uncontrolled. See Section 2.2.4.3 (Humidity Stress).
- d. Input Electrical Power: Use measured data or data from the electrical loads analysis for attack. (If trouble shooting, consider the effects of power transients. Attempt to replicate aircraft power.) See Section 2.2.4.4 (Electrical Stress).
- e. Supplemental Cooling: If required, the supplemental cooling shall meet the temperature and mass flow rates for the specific platform ECS system. For ECS systems open to the external environment, the mass flow rate to the LRU shall be adjusted for the pressure altitude. See Section 2.2.4.1 (Thermal Stress). It is imperative that the cooling system design be understood in order to properly replicate during test!
- f. Vibration: Vibration levels shall be based on the functional vibration levels for the specific materiel location and the specific mission segment under test. Vibration levels may vary throughout the test. See section 2.2.4.5 (Vibration Stress) and Method 514, annex A, paragraph 2.1.2.1 (Functional Vibration Definition).

4.4.3.6 Descent/Landing.

- a. Temperature: Ramp the temperature from the high altitude cruise temperature to the site temperature for the specific geophysical location. See Section 2.2.4.1 (Thermal Stress). The ramp rate shall be IAW the platform performance.
- b. Altitude: Ramp the altitude from the high altitude cruise/surveillance to the site altitude. The ramp rate shall be IAW the platform performance. See Section 2.2.4.2 (Altitude Stress).
- c. Humidity: Ramp the humidity to the measured value for the deployment site. If measured data is not available see MIL-HDBK-310. If descending into a warm/moist environment, there is the possibility that condensation will form on the materiel.
- d. Input Electrical Power: Use measured data or data from the electrical loads analysis for descent. (If trouble shooting, consider the effects of power transients. Attempt to replicate aircraft power.) See Section 2.2.4.4 (Electrical Stress).
- e. Supplemental Cooling: If required, the supplemental cooling shall meet the temperature and mass flow rates for the specific platform ECS system. For ECS systems open to the external environment, the mass flow rate to the LRU shall be adjusted for the pressure altitude. See Section 2.2.4.1 (Thermal Stress). It is imperative that the cooling system design be understood in order to properly replicate during test!
- f. Vibration: Vibration levels shall be based on the functional vibration levels for the specific materiel location and the specific mission segment under test. Vibration levels may vary throughout the test. See section 2.2.4.5 (Vibration Stress) and Method 514, annex A, paragraph 2.1.2.1 (Functional Vibration Definition).

MIL-STD-810H
METHOD 520.5

4.4.3.7 Maintenance.

- a. Temperature: Determine for the deployment location and any induced temperatures based on the material installation (solar loading, heating from adjacent material, etc.) Additional heat may be generated through the maintenance process of replacing specific components. See Section 2.2.4.1 (Thermal Stress).
- b. Altitude: Site altitude of the deployment location. See Section 2.2.4.2 (Altitude Stress)
- c. Humidity: Measured humidity at the deployment location. See Section 2.2.4.3 (Humidity Stress).
- d. Input Electrical Power (Ground Power/Aircraft Power); repeated power cycles may occur during maintenance. Ground Power shall replicate aircraft power and be within the aircraft normal operating limits. If troubleshooting, a power survey may be required of the specific aircraft power system to characterize the power quality at the LRU input. See Section 2.2.4.4 (Electrical Stress).
- e. Temperature Conditioned Air: When temperature conditioned air (heating/cooling) is required for maintenance in the field, conditioned air shall be provided to simulate the field maintenance conditions. (Note: Conditioned Air may not be available for all deployment locations/maintenance conditions. Test conditions should represent the actual conditions found in the field when possible.)

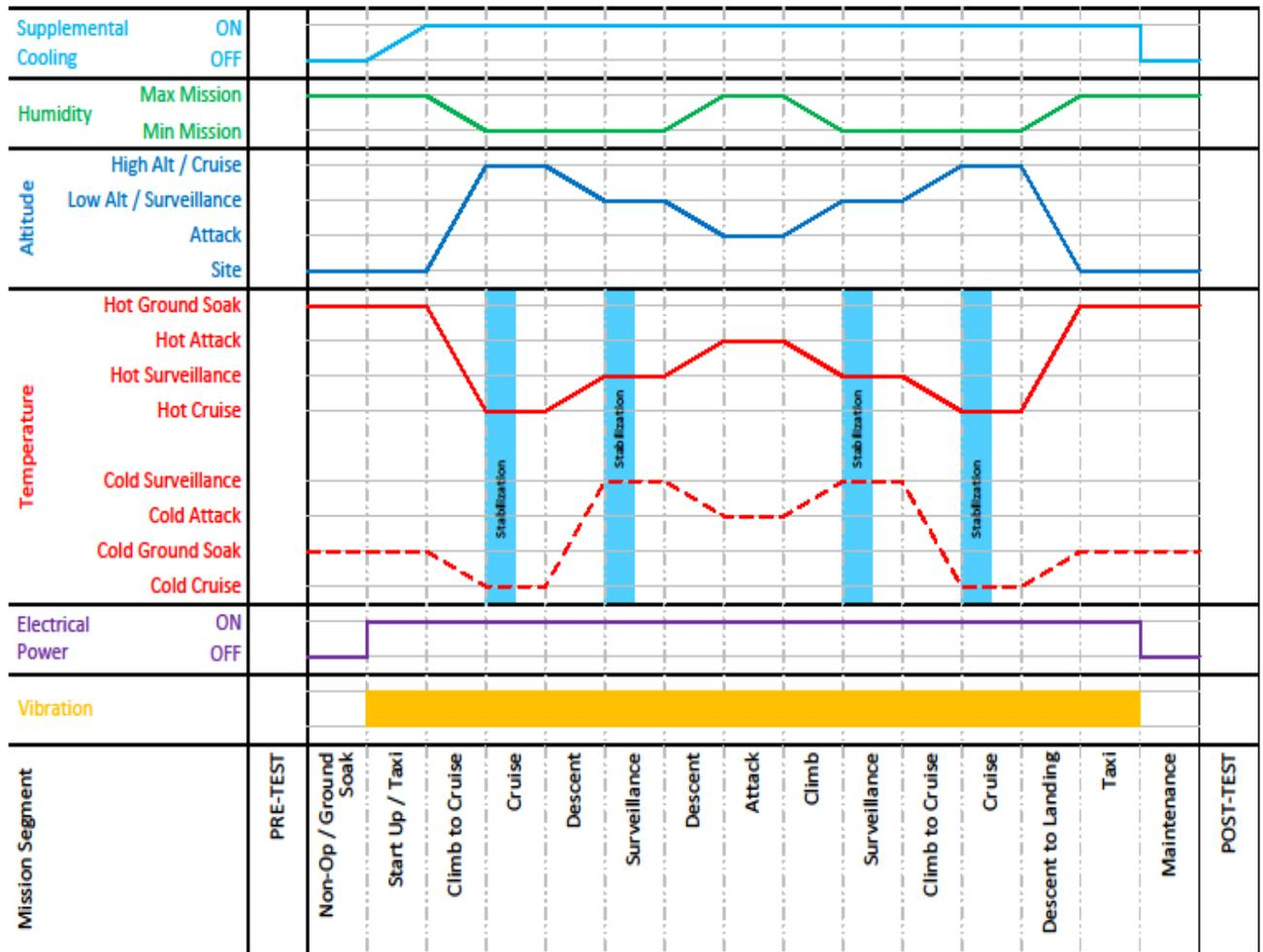
MIL-STD-810H
METHOD 520.5

Figure 520.5-2. Mission Specific/Troubleshooting Test Profile (Hot and Cold Day/Ground Attack) Notional Example (See notes for additional information.)

Figure 520.5-2. Notes:

1. Procedure II is intended for testing of unique mission profiles and troubleshooting. The profile steps must be tailored for the specific application. Steps may be added, repeated, or deleted based on the specific mission requirements.
2. Temperatures and Altitudes for troubleshooting shall be obtained from actual mission data, if possible.
3. Temperatures and Altitudes for mission specific testing shall be obtained from the relevant program office or mission needs statement based on the mission geophysical location.
4. Temperature Ramp Rate: IAW equipment or platform specification. If not specified, then <5 Deg C/min.
5. Altitude Ramp Rate: IAW Equipment for platform specification.
6. Humidity: The specific relationship between temperature, altitude, and humidity is highly variable and the profile should be considered as an example only. This parameter should be analyzed based on the specific mission geographic and atmospheric conditions. (Note: in the attack segment, if test chamber is unable to apply humidity at altitude, then this segment may be set to site pressure to incorporate the humidity parameter. This simulates a low level attack in a humid environment.)
7. Input Electrical Power:
 - a. Voltage: Alternate from cycle to cycle; Nominal, High, Low, High, etc. See Tables 520.5-III, IV, V, and VI for guidance.

MIL-STD-810H
METHOD 520.5

b. Frequency Variation: The input electrical power frequency shall be varied from cycle to cycle. . See Tables 520.5-III, V, and VI for guidance.

Note: Flight critical equipment may be required to operate under abnormal and/or emergency voltage condition. See Table IV and MIL-STD-704 for the appropriate levels. See paragraph 2.2.4.4. for additional guidance.

8. Supplemental Cooling temperature and mass flow rate shall be IAW the platform/system specification. There shall be no ECS supplemental cooling for the first 2 minutes following power on. This shall be followed by a linear drop in the ECS supplemental cooling air temperature to the specified cooling temperature. The ECS cooling air temperature ramp rate shall be determined from the platform ECS specification. For RAM cooled compartment a thermal analysis shall be performed per the guidance in paragraph 2.2.4.1.1.a.
9. Vibration may be performed separately with temperature. Vibration is intended to be tailored for the test items specific rotorcraft and/or fixed wing application and the levels should be in accordance with the levels expected during the specific mission segments.
10. It is preferred that consecutive cycles be run continuously; however, if test chamber operations preclude continuous operation, then the transition from high altitude to site, and from loiter temperature to minimum temperature shall be completed prior to interrupting the cycles. These conditions shall be maintained until the cycle is resumed.
11. Pre-Test, Post-test and Functional tests are performed to verify consistent satisfactory performance throughout the test. Pre and Post tests are generally the same. Functional tests, especially during altitude exposure, may be dependent on chamber access. These tests should be tailored per guidance in Part One.

4.4.4 Procedure III – Platform Envelope.

Procedure III is intended to verify operation across the platform envelope during exposure to multiple forcing functions. The test parameters are derived from the platform/materiel specification and tailored for the specific equipment location(s). There are two options within the procedure.

Option 1 applies materiel which, during its life cycle, is expected to be powered “ON” at temperatures either less than or greater than the normal operational temperature(s). This includes materiel that is powered “ON” concurrent with aircraft startup or that is powered “ON” while the aircraft is on the tarmac in a thermally ground soaked condition. Unless otherwise specified, the minimum and maximum start up temperatures will generally equate to the minimum and maximum ground soak temperatures (Figure 520.5-3a).

Option 2 applies to materiel which is powered “ON” during flight operations after the aircraft temperature has stabilized at its normal operational temperature. (Figure 520.5-3b)

Table 520.5-IX, Template: Procedure III Envelope test cycle (Based on Option 1) may be used to assist in development of the test profile. During testing, the completed table may also provide a quick reference to the test conditions at specific points in the test profile.

MIL-STD-810H
METHOD 520.5

Table 520.5-IX Template: Procedure I and III - Envelope test cycle (Based on Option 1)

The following table correlates to the profile steps and typical mission segments. This template shall be populated with actual parameters derived from Table 520.5-VIII. Reference Paragraph 2.3.1, Table 520.5-VIII, Step 9

STEP	Test Phase Definition	Temp °C (°F)	Relative Humidity	Supp. Cooling Air °C (°F)	Supp. Cooling Mass Flow (lbs/min)	Altitude	Test Item-Operating/non op.	Func Test	Duration
1	Pre-Test Set-up and Functional Test at Standard Ambient	Standard Ambient	Uncontrolled	N/A	N/A	Site	Operating/Non-operating (Note 8)	Yes	As Required
2.a	Ramp to Cold/Dry Min Power ON Temp	Ramp (Notes 1,2)	Uncontrolled	N/A	N/A	Site	Non-Operating	No	As Required
2.b	Cold/Dry Stabilization	Min. Power ON Temp (Notes 1, 3)	Uncontrolled	N/A	N/A	Site	Non-operating	No	As Required (See Part One, paragraph 5.4)
2.c	Cold/Dry Warm-up	Min. Power ON Temp (Note: Conditioned Air may be required for some equipment.)	Uncontrolled	N/A	N/A	Site	Operating (Note 8)	No	Minimum time required to perform power up and specified warm-up
2.d	Cold/Dry Functional test	Min. Power ON Temp (Note: Conditioned Air may be required for some equipment.)	Uncontrolled	N/A	N/A	Site	Operating (Note 8)	Yes	Minimum time required to perform functional test
2.e	Ramp to Op Temp (Warm-up)	Ramp (Notes 1, 2)	Uncontrolled	N/A	N/A	Site	Operating	No	As required
3	Cold/Dry Soak	Min. Op Temp (Note 1)	Uncontrolled	N/A	N/A	Site	Operating	No	2 hours minimum
4	Cold/Dry Functional test	Min. Op Temp (Note 1)	Uncontrolled	N/A	N/A	Site	Operating	Yes	Minimum time required to perform functional test

MIL-STD-810H
METHOD 520.5**Table 520.5-IX (Con't) Template: Procedure I and III - Envelope test cycle (Based on Option 1)**

The following table correlates to the profile steps and typical mission segments. This template shall be populated with actual parameters derived from Table 520.5-VIII. Reference Paragraph 2.3.1, Table 520.5-VIII, Step 9

STEP	Test Phase Definition	Temp °C (°F)	Relative Humidity	Supp. Cooling Air °C (°F)	Supp. Cooling Mass Flow (lbs/min)	Altitude	Test Item-Operating/non op.	Func Test	Duration
5	Ramp to Warm/Moist	Ramp to 32°C (Note 2)	Ramp to ≥ 95% RH (Note 10)	N/A	N/A	Site	Non-operating	No	As Required
6	Warm/Moist Soak	32°C (90°F)	95% RH	N/A	N/A	Site	Non-operating	No	1 hour minimum
7	Warm/Moist Functional Test	32°C (90°F)	95% RH	N/A	N/A	Site	Operating	Yes	As Required
8	Ramp to Cold/Dry Altitude	Ramp to Min Op Temp (Notes 1,2)	Uncontrolled	N/A	N/A	Ramp to Max Op Alt (Notes 4, 5)	Operating	No	As Required
9	Cold/Dry Altitude Soak	Min Op Temp	Uncontrolled	N/A	N/A	Max Op Alt	Operating	No	Stabilization, plus one hour; or 2 hours, whichever is less
10	Cold/Dry Altitude Functional test	Min Op Temp	Uncontrolled	N/A	N/A	Max Op Alt	Operating	Yes	
11	Ramp to Warm/Moist	Ramp to site (Note 2)	Ramp to ≥ 95% RH (Note 10)	N/A	N/A	Ramp (Note 5)	Operating	No	As Required
12	Warm/Moist Soak	+35°C	≥ 95% RH	N/A	N/A	Site	Operating	No	30 minutes minimum
13	Warm/Moist Functional test	+35°C	≥ 95% RH	N/A	N/A	Site	Operating	Yes	As Required
14	Power Off	+35°C	≥ 95% RH	N/A	N/A	Site	Non-Operating	No	As Required

MIL-STD-810H
METHOD 520.5

Table 520.5-IX (Con't) Template: Procedure I and III - Envelope test cycle (Based on Option 1)

The following table correlates to the profile steps and typical mission segments. This template shall be populated with actual parameters derived from Table 520.5-VIII. Reference Paragraph 2.3.1, Table 520.5-VIII, Step 9

STEP	Test Phase Definition	Temp °C (°F)	Relative Humidity	Supp. Cooling Air °C (°F)	Supp. Cooling Mass Flow (lbs/min)	Altitude	Test Item-Operating/non op.	Func Test	Duration
15.a	Ramp to Hot/Dry Max Power ON temp	Ramp (Notes 1, 2)	Ramp to <10%	N/A	N/A	Site	Non-operating	No	As Required
15.b	Hot/Dry Stabilization	Max Power ON Temp (Notes 1, 3)	<10%	N/A	N/A	Site	Non-operating	No	As Required (See Part One, paragraph 5.4)
15.c	Hot/Dry Power ON	Max Power ON Temp (Note 1)	<10%	Per Spec (Note 9)	Per Spec (Note 9)	Site	Operating (Note 8)	No	Minimum time required to perform power up
15.d	Hot/Dry Functional Test	Max Power ON Temp (Note 1)	<10%	Per Spec (Note 9)	Per Spec (Note 9)	Site	Operating (Note 8)	Yes	Minimum time to perform functional test
15.e	Ramp to Operational Temperature	Ramp (Notes 1, 2)	<10%	Per Spec	Per Spec	Site	Operating	No	As Required
16	Hot/Dry Soak	Max Op Temp (Note 1)	<10%	Per Spec	Per Spec	Site	Operating	No	2 hours minimum
17	Hot/Dry Functional test	Max Op Temp (Note 1)	<10%	Per Spec	Per Spec	Site	Operating	Yes	As Required
18	Ramp to Hot/Dry Altitude	Max Op Temp	<10%	Per Spec	Ramp (Adjust Mass Flow for Alt)	Ramp to Max Op Alt (Note 5)	Operating	No	As Required

MIL-STD-810H
METHOD 520.5**Table 520.5-IX (Con't) Template: Procedure I and III - Envelope test cycle (Based on Option 1)**

The following table correlates to the profile steps and typical mission segments. This template shall be populated with actual parameters derived from Table 520.5-VIII. Reference Paragraph 2.3.1, Table 520.5-VIII, Step 9

STEP	Test Phase Definition	Temp °C (°F)	Relative Humidity	Supp. Cooling Air °C (°F)	Supp. Cooling Mass Flow (lbs/min)	Altitude	Test Item-Operating/non op.	Func Test	Duration
19	Hot/Dry High Altitude Functional test	Max Op Temp	<10%	Per Spec	Mass Flow adjusted for Alt	Max Op Alt	Operating	Yes	15 minutes minimum
20	Ramp to Loiter/Cruise Temp	Ramp (Max Op Temp to Cruise Op Temp) (Note 6)	<10%	Per Spec	Mass Flow adjusted for Alt	Max Op Alt	Operating	No	45 minutes minimum
21	Loiter/Cruise Altitude Ramp	Cruise Op Temp (Note 6)	<10%	Per Spec	Ramp (Adjust Mass Flow for Cruise Alt)	Ramp to Cruise Alt (Note 5)	Operating	No	As Required
22	Hot/Dry Loiter/Cruise Soak	Cruise Op Temp	<10%	Per Spec	Mass Flow adjusted for Cruise Alt	Cruise Alt (Note 7)	Operating	No	3 hours minimum
23	Hot/Dry Loiter/Cruise Functional test	Cruise Op Temp	<10%	Per Spec	Mass Flow adjusted for Cruise Alt	Cruise Alt (Note 7)	Operating	Yes	As Required
24	Ramp to Site Ambient	Ramp to ambient (Note 2)	<10%	Per Spec	Per Spec	Ramp to Site (Note 5)	Operating/Non-Operating	No	As Required
25	Repeat Steps 2 thru 24 as required								

MIL-STD-810H
METHOD 520.5

Table 520.5-IX (Con't) Template: Procedure I and III - Envelope test cycle (Based on Option 1)

The following table correlates to the profile steps and typical mission segments. This template shall be populated with actual parameters derived from Table 520.5-VIII. Reference Paragraph 2.3.1, Table 520.5-VIII, Step 9

STEP	Test Phase Definition	Temp °C (°F)	Relative Humidity	Supp. Cooling Air °C (°F)	Supp. Cooling Mass Flow (lbs/min)	Altitude	Test Item- Operating/non op.	Func Test	Duration
26	Post Functional Test	Standard Ambient	Uncontrolled	Off	OFF	Site	Operating/Non-operating	Yes	Minimum Time required Post Test and power down

Table 520.4-IX Notes:

1. Temperature parameters shall be the extreme platform envelope values for the test condition.
2. Temperature Ramp Rate: IAW equip specification. If not specified, then ≤ 5 Deg C/min.
3. Stabilization:
Non-Operational Equipment: See Part One, paragraph 5.4.2
Operational Equipment: See Part One, paragraph 5.4.1
4. Altitude parameters shall be maximum platform envelope values for the test condition.
5. Altitude Ramp Rate: IAW equipment specification.
6. Loiter/Cruise Op Temp: Localized ambient air temp with inflight atmospheric cooling effects. IAW Platform guidance. If guidance is not provided, use the maximum operational temperature.
7. Loiter/Cruise Altitude: As determined by the Program Office. This shall represent a typical long duration cruise altitude. If guidance is not provided, use the maximum operational altitude.
8. Input Electrical Power:
 - a. Voltage; Alternate from cycle to cycle; Nominal, High, Low, High, etc. See Tables 520.5-III, IV, V, and VI for guidance.
 - b. Frequency Variation: The input electrical power frequency shall be varied from cycle to cycle. . See Tables 520.5-III, V, and VI for guidance.
9. Supplemental Cooling temperature and mass flow rate shall be IAW the platform/system specification. There shall be no ECS supplemental cooling for the first 2 minutes following power on. This shall be followed by a linear drop in the ECS supplemental cooling air temperature to the specified cooling temperature. The ECS cooling air temperature ramp rate shall be determined from the platform ECS specification. For RAM cooled compartment a thermal analysis shall be performed per the guidance in paragraph 2.2.4.1.1. a.
10. It is permissible to delay the humidity ramp until the chamber temperature reaches 0 C.
11. Vibration is an integral part of the flight environment. Although not shown on the above table, when added to the test the vibration levels shall be representative of the functional vibration levels for the specific phase of the mission.

MIL-STD-810H
METHOD 520.5

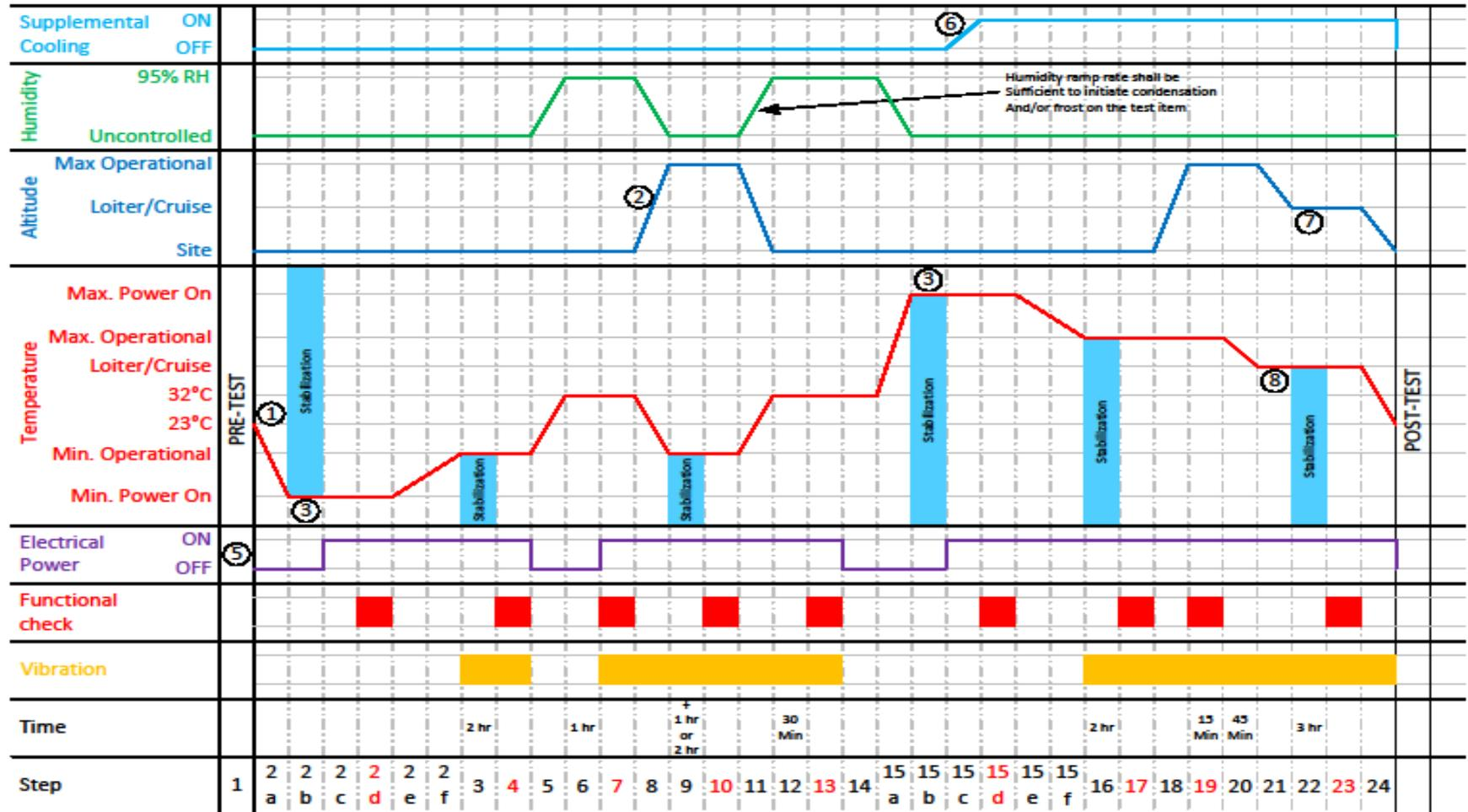


Figure 520.5-3a. Platform Envelope Option 1 Profile Example (See notes for additional information.)

MIL-STD-810H
METHOD 520.5

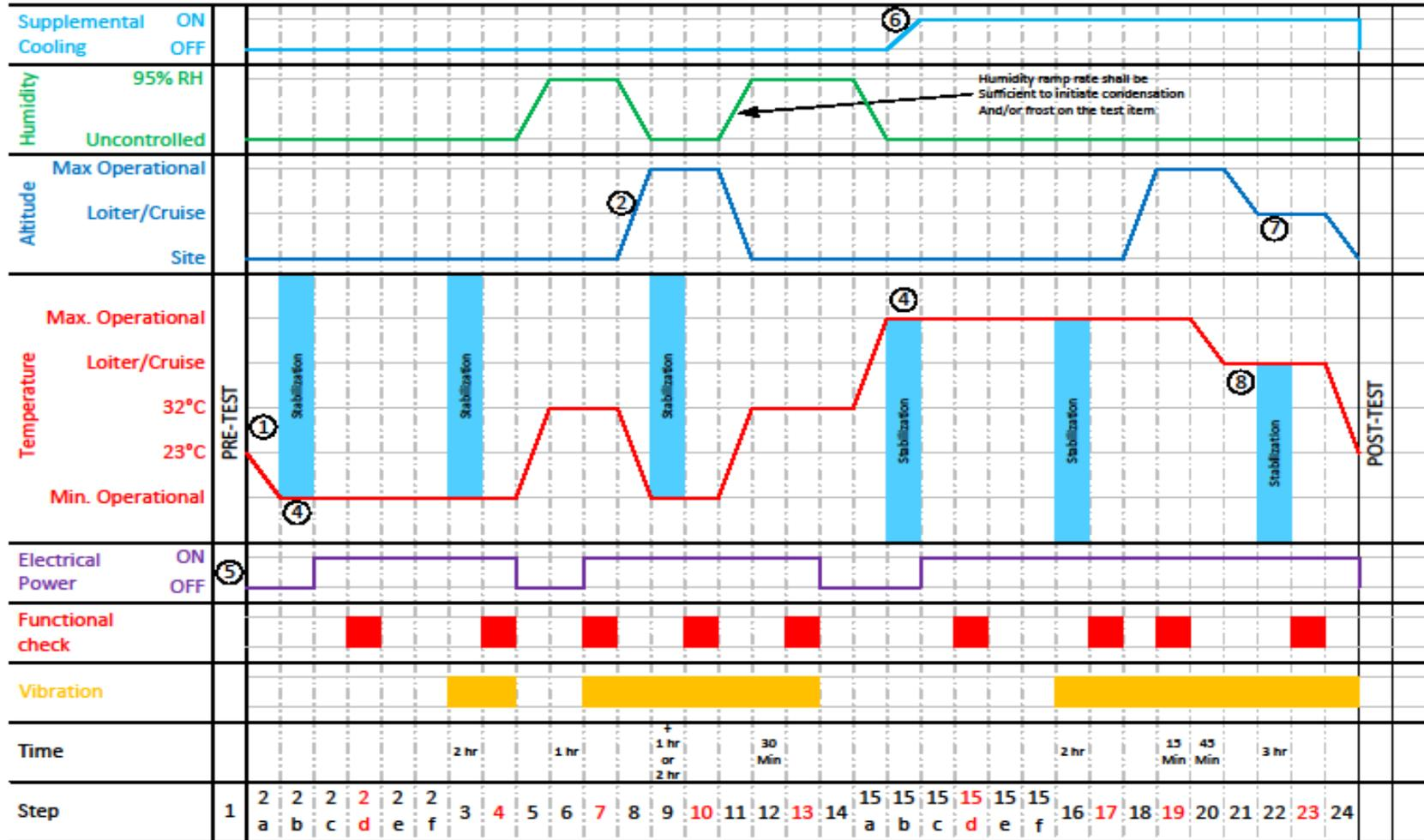


Figure 520.5-3b. Platform Envelope Option 2 Profile Example (See notes for additional information.)

MIL-STD-810H
METHOD 520.5

Figures 520.5-3a and 520-3b. Notes:

1. Temperature Ramp Rate: IAW equipment or platform(s) specification. If not specified then <5 Deg C/min.
2. Altitude Ramp Rate: IAW equipment or platform(s) specification.
3. Option 1 applies materiel which, during its life cycle, is expected to be powered "ON" at temperatures either less than or greater than the normal operational temperature. This includes materiel that is powered "ON" concurrent with aircraft startup or that is powered "ON" while the aircraft is on the tarmac in a thermally ground soaked condition. Unless otherwise specified, the minimum and maximum start up temperatures will generally equate to the minimum and maximum ground soak temperatures (Figure 520.5-3a).
4. Option 2 applies to materiel which is powered "ON" during flight operations after the aircraft temperature has stabilized at its normal operational temperature. (Figure 520.5-3b)
5. Input Electrical Power:
 - a. Voltage: Alternate from cycle to cycle; Nominal, High, Low, High, etc. See Tables 520.5-III, IV, V, and VI for guidance.
 - b. Frequency Variation: The input electrical power frequency shall be varied from cycle to cycle. . See Tables 520.5-III, V, and VI for guidance.

Note: Flight critical equipment may be required to operate under abnormal and/or emergency voltage condition. See Table IV and MIL-STD-704 for the appropriate levels. See paragraph 2.2.4.4. for additional guidance.
6. Supplemental Cooling temperature and mass flow rate shall be IAW the platform/system specification. There shall be no ECS supplemental cooling for the first 2 minutes following power on. This shall be followed by a linear drop in the ECS supplemental cooling air temperature to the specified cooling temperature. The ECS cooling air temperature ramp rate shall be determined from the platform ECS specification. For RAM cooled compartment a thermal analysis shall be performed per the guidance in paragraph 2.2.4.1.1.a.
7. Loiter Altitude: IAW Platform guidance. If guidance is not provided, use the maximum operational altitude.
8. Loiter Temperature: IAW Platform guidance and location of equipment. If guidance is not provided, use the maximum operational temperature.
9. Vibration may be performed separately with temperature. Vibration is intended to be tailored for the test items specific rotorcraft and/or fixed wing application and the levels should be in accordance with the levels expected during the specific mission segments.
10. It is preferred that consecutive cycles be run continuously; however, if test chamber operations preclude continuous operation, then the transition from high altitude to site, and from loiter temperature to minimum temperature shall be completed prior to interrupting the cycles. These conditions shall be maintained until the cycle is resumed.
11. Pre-Test, Post-test and Functional tests are performed to verify consistent satisfactory performance throughout the test. Pre and Post tests are generally the same. Functional tests, especially during altitude exposure, may be dependent on chamber access. These tests should be tailored per guidance in Part One.
12. For External stores/munitions the solar equivalent temperature may be used to determine the high altitude temperature parameters. Referenced JOTP-012.
13. Humidity: The humidity ramp rate for steps 5, 8, and 15A shall track the temperature ramp. The humidity ramp rate for step 11 shall be sufficient to initiate condensation and/or frost on the test item.

4.4.4.1 Procedure III - Steps.

Step 1: Perform Pre-Test Set-up and Functional Test at Standard Ambient conditions. See paragraph 4.4.1 and subparagraphs.

Step 2: Cold/Dry (Perform either Option 1 or Option 2)

Option 1: Equipment which is Powered ON at temperatures less than the normal operating temperature (Figure 520.5-3a, Note 3):	Option 2: Equipment Powered ON during the mission at Operational Temperature (Figure 520.5-3b, Note 4):
a. Ramp to Cold/Dry Min Power ON Temp: With the test item(s) non-operating, ramp the chamber temperature from standard ambient conditions to the Min Power ON temperature at a rate of no more than 5°C/minute (9°F/minute).	a. Ramp to Operational Cold/Dry - With the test item(s) non-operating, ramp the chamber temperature from standard ambient conditions to the low operating temperature at a rate of no more than 5 °C/minute (9°F/minute).
b. Cold/Dry Stabilization - Stabilize the test item at the Min Power ON temperature. Reference Part One paragraph 5.4.2.	b. Cold/Dry Stabilization - Stabilize the test item at the low operational temperature. Reference Part One paragraph 5.4.2.
c. Cold/Dry Warm-up - Power ON the test item at the required voltage (nominal, high, low) and frequency (See Table 520.5-III). Maintain this condition for the minimum specified warm-up period. (Note: some equipment may require conditioned air prior to start up.)	c. Cold/Dry Warm-up - Power ON the test item at the required voltage (nominal, high, low) and frequency (See Table 520.5-III). Maintain this condition for the minimum specified warm-up period. (Note: some equipment may require conditioned air prior to start up.)

MIL-STD-810H
METHOD 520.5

Option 1 (Con't): Equipment which is Powered ON at temperatures less than the normal operating temperature (Figure 520.5-3a, Note 3):	Option 2 (Con't): Equipment Powered ON during the mission at Operational Temperature (Figure 520.5-3b, Note 4):
d. Cold/Dry Functional Test - Perform a functional test immediately following Option 1, step 2.c, to verify the test item operates as required and record data for comparison with pre-test and post-test data. If the test item fails to operate as intended, see paragraph 5 (Analysis of Results) for failure analysis and follow the guidance in paragraph 4.3.2 for test item failure.	d. Cold/Dry Functional Test - Perform a functional test immediately following Option 2, step 2.c, to verify the test item operates as required and record data for comparison with pre-test and post-test data. If the test item fails to operate as intended, see paragraph 5 (Analysis of Results) for failure analysis and follow the guidance in paragraph 4.3.2 for test item failure.
e. Ramp to Operational Temperature (Warm-up) - At the completion of the functional test, with the test item operating, ramp the chamber to the low operational temperature at a rate of no more than 5 °C/minute (9°F/minute).	e. At the completion of the functional test, with the test item operating, proceed to step 3.
f. Proceed to step 3	

Step 3: Cold/Dry Soak – Allow the test item to soak at the low operational temperature for two (2) hours, or until the unit stabilizes, whichever is greater. If vibration is to be performed during this step, see paragraph 2.2.4.5 for requirements development. Continue vibration through step 4. (Note: Vibration levels may vary from step to step depending on the operational conditions.)

Step 4: Cold/Dry Functional test – Perform a functional test immediately following Step 3 to verify the test item operates as required and record data for comparison with pre-test and post-test data. If the test item fails to operate as intended, see paragraph 5 (Analysis of Results) for failure analysis and follow the guidance in paragraph 4.3.2 for test item failure.

Step 5: Ramp to Warm/Moist – At the completion of the functional test, power OFF the test item. With the test item non-operating, ramp the chamber conditions from Step 4 to +32°C (+90°F) and 95% relative humidity (RH). Perform this temperature/humidity ramp at the following rates: Temperature - no more than 5°C/minute (9°F/minute); Humidity – tracking the temperature ramp. (Note: it is permissible to delay the humidity ramp until the chamber temperature reaches 0°C).

Step 6: Warm/Moist Soak – With the test item non-operating, maintain +32°C (+90°F), 95% RH, and site pressure for one (1) hour. This step simulates an aircraft sitting on the tarmac in a warm/humid environment.

Step 7: Warm/Moist Functional Test – Power ON the test item and perform a functional check. If vibration is to be performed during this step, see paragraph 2.2.4.5 for requirements development. Continue vibration through step 13. (Note: Vibration levels may vary from step to step depending on the operational conditions.)

Step 8: Ramp to Cold/Dry Altitude – At the completion of the functional test, with the test item operating, ramp the chamber from the conditions in step 6 to the low operational temperature, the maximum operating altitude (use the formulas in Table 520.5-II to derive pressure from altitude), and uncontrolled humidity. Perform this temperature altitude ramp at the maximum facility rate, not to exceed the predicted platform rate. This step simulates an ascent from a warm/humid environment to a cold/dry altitude. Document presence of moisture/frost/ice on the test item. Photographic documentation is preferred.

Step 9: Cold/Dry Altitude Soak – With the test item operating, maintain the conditions of step 8 until the test item has stabilized, plus one hour; or 2 hours, whichever is less.

Step 10: Cold/Dry Altitude Functional test – Perform a functional test immediately following Step 9 to verify the test item operates as required and record data for comparison with pre-test and post-test data. If the test item fails to operate as intended, see paragraph 5 (Analysis of Results) for failure analysis and follow the guidance in paragraph 4.3.2 for test item failure.

MIL-STD-810H
METHOD 520.5

Step 11: Ramp to Warm/Moist – At the completion of the functional test, with the test item operating, ramp the chamber conditions from Step 10 and uncontrolled humidity to +32°C (+90°F), 95% relative humidity (RH), and site pressure. Perform this temperature/humidity/altitude ramp at the following rates: Temperature - no more than 5 °C/minute (9 °F/minute); Humidity – maximum facility rate (Note: it is permissible to delay the humidity ramp until the chamber temperature reaches 0°C); Altitude – maximum platform descent rate. This step simulates a rapid descent from a high altitude to a hot/humid day landing site. (Note: The humidity ramp rate shall be sufficient to initiate condensation and/or frost on the test item.)

Step 12: Warm/Moist Soak – With the test item operating, maintain +32°C (+90°F), 95% RH, and site pressure for 30 minutes.

Step 13: Warm/Moist Functional test – Perform a functional test immediately following Step 12 to verify the test item operates as required and record data for comparison with pre-test and post-test data. If the test item fails to operate as intended, see paragraph 5 (Analysis of Results) for failure analysis and follow the guidance in paragraph 4.3.2 for test item failure.

Step 14: Power OFF the test item

Step 15: Hot/Dry (Perform either Option 1 or Option 2)

Option 1: Equipment which is Powered ON at temperatures greater than the normal operating temperature (Figure 520.5-3a and Note 3):	Option 2: Equipment Powered ON during the mission at Operational Temperature (Figure 520.5-3b and Note 4):
a. Ramp to Hot/Dry Max Power ON temp: With the test item(s) non-operating, ramp the chamber temperature to the Max Power ON temperature at a rate of no more than 5 °C/minute (9 °F/minute).	a. Ramp to Operational Hot/Dry - With the test item(s) non-operating, ramp the chamber temperature to the high operational temperature at a rate of no more than 5 °C/minute (9 °F/minute).
b. Hot/Dry Stabilization - Stabilize the test item at the Max Power On temperature. Reference Part One paragraph 5.4.2.	b. Hot/Dry Stabilization - Stabilize the test item at the high operational temperature. Reference Part One paragraph 5.4.2. If supplement cooling is required, there shall be no supplemental cooling for the first 2 minutes of the stabilization period. This shall be followed by a linear drop in the supplemental cooling air temperature to the specified cooling temperature. The cooling air temperature ramp rate shall be determined from the platform ECS specification.
c. Hot/Dry Power ON - Power ON the test item at the required voltage (nominal, high, low) and frequency (See Table 520.5-III). If supplemental cooling is required, there shall be no supplemental cooling for the first 2 minutes following power on. This shall be followed by a linear drop in the supplemental cooling air temperature to the specified cooling temperature. The cooling air temperature ramp rate shall be determined from the platform ECS specification.	c. Hot/Dry Power ON - Power ON the test item at the required voltage (nominal, high, low) and frequency (See Table 520.5-III).
d. Hot/Dry Functional Test - Perform a functional test immediately after Power ON in option 1, step 15.c to verify the test item operates as required and record the test data for comparison with pre-test and post-test data. If the test item fails to operate as intended, see paragraph 5 (Analysis of Results) for failure analysis and follow the guidance in paragraph 4.3.2 for test item failure.	d. Hot/Dry Functional Test - Perform a functional test immediately after Power ON in option 2, step 15.c to verify the test item operates as required and record the test data for comparison with pre-test and post-test data. If the test item fails to operate as intended, see paragraph 5 (Analysis of Results) for failure analysis and follow the guidance in paragraph 4.3.2 for test item failure.

MIL-STD-810H
METHOD 520.5

Option 1 (Con't): Equipment which is Powered ON at temperatures greater than the normal operating temperature (Figure 520.5-3a and Note 3):	Option 2 (Con't): Equipment Powered ON during the mission at Operational Temperature (Figure 520.5-3b and Note 4):
e. Ramp to Operational Temperature - At the completion of the functional test, with the test item operating, ramp the chamber temperature to the high operational temperature at a rate of no more than 5°C/minute (9 °F/minute)	e. At the completion of the functional test, with the test item operating, proceed to step 16.
f. Proceed to step 16	

- Step 16: Hot/Dry Soak – Maintain the test conditions for two (2) hours, or until the test item stabilizes, whichever is greater. If vibration is to be performed during this step, see paragraph 2.2.4.5 for requirements development. Continue vibration thru step 24. (Note: Vibration levels may vary from step to step depending on the operational conditions.)
- Step 17: Hot/Dry Functional test – Perform a functional test to verify that the test item operates as required immediately after step 16 and record data for comparison with pre-test and post-test data. If the test item fails to operate as intended, see paragraph 5 for failure analysis and follow the guidance in paragraph 4.3.2 for test item failure.
- Step 18: Ramp to Hot/Dry Altitude – At the completion of the functional test, with the test item operating, ramp the chamber from site pressure to the maximum operating altitude (use the formulas in Table 520.5-II to derive pressure from altitude). Perform this pressure ramp at the maximum platform ascent rate.
- Step 19: Hot/Dry High Altitude Functional test – Perform a functional test immediately following step 18 to verify that the test item operates as required and record data for comparison with pre-test and post-test data. If the test item fails to operate as intended, see paragraph 5 for failure analysis and follow the guidance in paragraph 4.3.2 for test item failure. Maintain these conditions for a minimum of 15 minutes or until the functional test is complete.
- Step 20: Ramp to Loiter/Cruise Temperature – At the completion of the functional test, ramp the temperature to the required Loiter temperature over a period of forty five (45) minutes. This ramp time shall be based on expected materiel location thermal conditions and cool down times, it may be less or more than 45 minutes.
- Step 21: Loiter/Cruise Altitude Ramp – At the conclusion of step 20, ramp the chamber pressure from the maximum operational altitude to the Loiter Cruise Altitude. Perform the ramp at the maximum platform descent rate. (Note: if the maximum operational altitude and loiter/cruise altitudes are the same, then skip this step.)
- Step 22: Hot/Dry Loiter/Cruise Soak – With the test item operating, maintain the Loiter operating temperature and Loiter cruise altitude for 3 hours, or until the test item stabilizes, whichever is greater.
- Step 23: Hot/Dry Loiter/Cruise Functional test – Perform a functional test immediately after step 22 to verify that the test item operates as required and record data for comparison with pre-test and post-test data. If the test item fails to operate as intended, see paragraph 5 for failure analysis and follow the guidance in paragraph 4.3.2 for test item failure.
- Step 24: Ramp to Site Ambient – At the completion of the functional test, ramp the chamber from the maximum operating temperature and Loiter operating altitude to site ambient temperature, site pressure, and uncontrolled humidity. Perform the temperature ramp at a rate of no more than 5 °C/minute (9 °F/minute) and the altitude ramp at the platform maximum descent rate. Return the test item to a non-operating condition and discontinue the supplemental cooling at the conclusion of the ramp.
- Step 25: Repeat Steps 2 through 24 for the total number of cycles required. Historically a minimum of 10 cycles has been recommended. (Note: For test flight purposes, a minimum of 3 cycles has historically been required for Safety of Flight.)

MIL-STD-810H
METHOD 520.5

Step 26: Post Functional Test – Perform a functional test to verify that the test item operates as required and record data for comparison with pre-test and during test data. If the test item fails to operate as intended, see paragraph 5 for failure analysis and follow the guidance in paragraph 4.3.2 for test item failure.

5. ANALYSIS OF RESULTS.

5.1 Analysis of Test Results.

Use the guidance provided in Part One, paragraphs 5.14 and 5.17, and Part One, Annex A, Task 406 to evaluate the test results.

5.2 Analysis of Failures.

Analyze in detail any failure of a test item to meet the requirements of the materiel specifications. If the test item failed the test, consider the following categories during analysis of results of this Method:

- a. Stress. If a failure occurred, what the immediate physical mechanism of failure may have been, e.g., fatigue, short circuit by particulate, etc.
- b. Loading mechanism. Determine the physical loading mechanism that led to failure and the total time or number of cycles to failure (e. g., structural dynamic resonant modes, mode shapes, stress distribution; static deformation due to temperature distribution, incursion of moisture, etc.).
- c. Test Compliance. Evaluate test performance, including any test plan redlines/deviations; e.g., out of tolerance test conditions, supporting equipment anomalies, facility issues, test interruptions, power interruptions/spikes.
- d. Source. Failures may be induced by a specific environmental stress or a combination of environmental stresses and/or the dynamic of changing stresses. The failures may result from design flaws, faulty parts, workmanship, manufacturing process, etc. The failure may exhibit as a hard failure, intermittent failure, etc. Depending on the nature of the failure, a failure analysis/root cause analysis may be required to determine the ultimate cause and corrective action prior to resumption of testing.
- e. Criticality. Does the failure impact mission and/or flight criticality?

6. REFERENCE/RELATED DOCUMENTS.

6.1 Referenced Documents.

- a. Hall, P.S., Vibration Test Level Criteria for Aircraft Equipment, AFWAL-TR-80-3119, December 1980.
- b. MIL-HDBK-310, Global Climatic Data for Developing Military Products.
- c. NATO STANAG 4370, Allied Environmental Conditions and Test Publication (AECTP) 230, Climatic Conditions.
- d. Aircraft Electrical Power System Characteristics, STANAG 3456, Edition 7 March 2014.
- e. Joint Ordnance Test Procedure (JOTP)-012, Safety and Suitability for Service Assessment Testing for Aircraft Launched Munitions, 1 July 2013.
- f. MIL-STD-704, Aircraft Electric Power Characteristics
- g. MIL-HDBK-704, Guidance for Test Procedures for Demonstration of Utilization Equipment Compliance to Aircraft Electrical Power Characteristics
- h. RTCA DO-160, Environmental Conditions and Test Procedures for Airborne Equipment
- i. MIL-STD-1399/300B, Department of Defense Interface Standard: (Section 300B) Electric Power, Alternating Current (24 APR 2008)
- j. MIL-STD-2218, Thermal Design, Analysis and Test Criteria for Airborne Electronic Equipment, 20 May 1992

MIL-STD-810H
METHOD 520.5

6.2 Related Documents.

- a. Sevy, R.W., Computer Program for Vibration Prediction of Fighter Aircraft Equipment, AFFDL-TR-77-101, November 1977.
- b. Lloyd, A.J.P., G.S. Duleba, and J.P. Zeebenm, Environmental Control System (ECS) Transient Analysis, AFFDL-TR-77-102, October 1977.
- c. Dieckmann, A.C., et al, Development of Integrated Environmental Control Systems Design for Aircraft, AFFDL-TR-72-9, May 1972.
- d. Quart, I., A.H. Samuels, and A.J. Curtis, A Study of the Cost Benefits of Mission Profile Testing, AFWAL-TR-81-3028, 1981.
- e. Burkhard, A.H., et al, CERT Evaluation Program Final Report, AFWAL-TR-82-3085.
- f. F-15 AFDT&E High-Temperature Desert Test and Climatic Laboratory Evaluation, AFFTC-TR-75-19, October 1975, DTIC Number AD B011345L.
- g. STANAG 4370, Environmental Testing.
- h. Allied Environmental Conditions and Test Publication (AECTP) 300, Climatic Environmental Tests (under STANAG 4370), Method 317.
- i. Egbert, Herbert W., “The History and Rationale of MIL-STD-810 (Edition 2)”, January 2010, Institute of Environmental Sciences and Technology, Arlington Place One, 2340 S. Arlington Heights Road, Suite 100, Arlington Heights, IL 60005-4516.

(Copies of Department of Defense Specifications, Standards, and Handbooks, and International Standardization Agreements are available online at <https://assist.dla.mil>.)

Requests for other defense-related technical publications may be directed to the Defense Technical Information Center (DTIC), ATTN: DTIC-BR, Suite 0944, 8725 John J. Kingman Road, Fort Belvoir VA 22060-6218, 1-800-225-3842 (Assistance--selection 3, option 2), <http://www.dtic.mil/dtic/>; and the National Technical Information Service (NTIS), Springfield VA 22161, 1-800-553-NTIS (6847), <http://www.ntis.gov/>.

MIL-STD-810H
METHOD 520.5 ANNEX A**METHOD 520.5, ANNEX A**
Supplemental Tailoring Guidance

An individual platform is designed to operate within a set of specified operating mission envelopes (Mach number/altitude regime) and profiles (see Figure 520.5A-1). For example, an aircraft can fly many different missions such as training, air superiority, interdiction, ground support, etc. Often, high-threat combat will generate more extreme environments; such as increased temperature effects, dynamic pressures, vibration, condensation, etc. Reference Method 514, Annex A, paragraph 2.6.

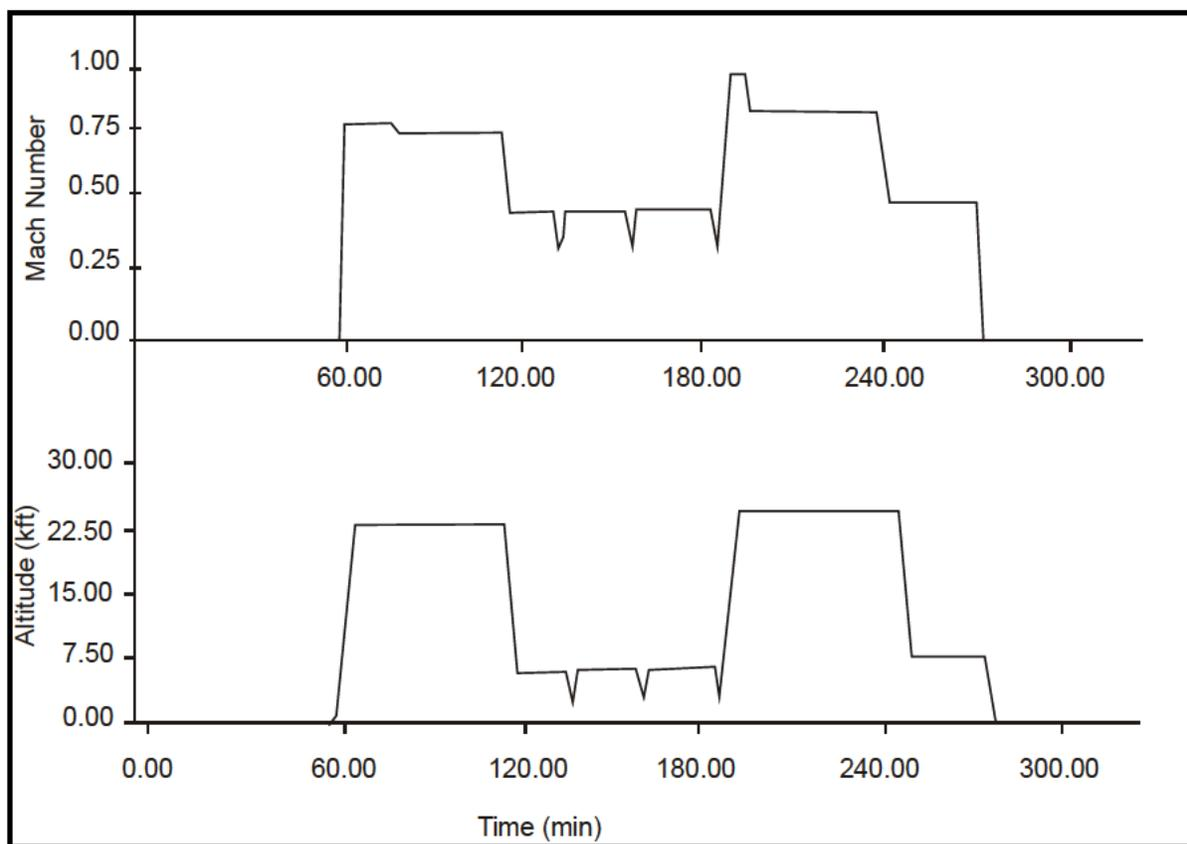


Figure 520.5A-1. Schematic mission profile, altitude, and Mach number (F-15 ground attack example).

MIL-STD-810H
METHOD 520.5 ANNEX A

The Standard Atmospheric Models presented in Tables 520.5A-I thru 520.5A-III may be used in determining the altitude, temperature, relative humidity, and dew point correlations when specific flight data is not available. Reference paragraphs 2.2.4.2 (Altitude Stress) and 2.2.4.3 (Humidity Stress).

**Table 520.5A-I. Ambient outside air temperatures.
HOT ATMOSPHERE MODEL**

<u>Altitude</u>		<u>World-Wide Air Operations</u>		<u>Relative Humidity (%)</u>	<u>Dew Temperature</u>	
km	kft	°C	°F		°C	°F
0	0.00	43	109	<10	4	40
1	3.28	34	93	<10	-2	29
2	6.56	27	81	<10	-6	21
4	13.10	12	54	<10	-17	2
6	19.70	0	32	<100	0	32
8	26.20	-11	12	<100	-11	12
10	32.80	-20	-4	<100 ^{1/}	-20	-4
12	39.40	-31	-24	<100	-31	-24
14	45.90	-40	-40	<100	-40	-40
16	52.50	-40	-40	<100	-40	-40
18	59.10	-40	-40	<100	-40	-40
20	65.60	-40	-40	<100	-40	-40
22	72.20	-39	-38	<100	-39	-38
24	78.70	-39	-38	<100	-39	-38
26	85.30	-39	-36	<100	-38	-36
28	91.90	-36	-33	<100	-36	-33
30	98.40	-33	-27	<100	-33	-27
Hot Ground Soak ^{2/}		71	160	<10	26	78

Table 520.5A-I Notes:

^{1/}Uncontrolled humidity (dry as possible).

^{2/}Ground soak temperatures are not necessarily related to measured data but are extreme levels to reduce ground soak time.

**Table 520.5A-II. Ambient outside air temperatures.
COLD ATMOSPHERE MODEL**

<u>Altitude</u>		<u>World-Wide Air Operations</u>		<u>Relative Humidity (%)</u>	<u>Dew Temperature</u>	
km	kft	°C	°F		°C	°F
0	0.00	-51	-60	<100 ^{1/}	-51	-60
1	3.28	-49	-56	<100	-49	-56
2	6.56	-31	-24	<100	-31	-24
4	13.10	-40	-40	<100	-40	-40
6	19.70	-51	-60	<100	-52	-60
8	26.20	-61	-78	<100	-61	-78
10	32.80	-65	-85	<100	-65	-85
12	39.40	-67	-89	<100	-57	-89
14	45.90	-70	-94	<100	-70	-94
16	52.50	-82	-116	<100	-82	-116
18	59.10	-80	-112	<100	-80	-112
20	65.60	-79	-110	<100	-79	-110
22	72.20	-80	-112	<100	-80	-112
24	78.70	-80	-112	<100	-80	-112
26	85.30	-79	-110	<100	-79	-110
28	91.90	-77	-107	<100	-77	-107
30	98.40	-76	-105	<100	-76	-105
Cold Ground Soak ^{2/}		-54	-65	<100	-54	-65

MIL-STD-810H
METHOD 520.5 ANNEX A

**Table 520.5A-III. Ambient outside air temperatures.
WARM MOIST ATMOSPHERE MODEL**

<u>Altitude</u>		<u>World-Wide Air Operations</u>		<u>Relative Humidity (%)</u>	<u>Dew Temperature</u>	
km	(kft)	°C	°F		°C	°F
0	0.00	32.1	90	<85	29	85
1	3.28	25.0	77	<85	22	72
2	6.56	19.0	66	<85	17	62
4	13.10	4.0	39	<85	2	35
6	19.70	-11.0	13	<85	-13	9
8	26.20	-23.0	-10	<85	-25	-13
10	32.80	-38.0	-36	<100 ^{1/}	-38	-36
12	39.40	-52.0	-62	<100	-52	-62
14	45.90	-67.0	-88	<100	-67	-88
16	52.50	-78.0	-108	<100	-78	-108
18	59.10	-73.0	-100	<100	-73	-100
20	65.60	-65.0	-85	<100	-65	-85
22	72.20	-58.0	-72	<100	-58	-72
24	78.70	-53.0	-63	<100	-53	-63
26	85.30	-48.0	-54	<100	-48	-54
28	91.90	-43.0	-45	<100	-43	-45
30	98.40	-38.0	-36	<100	-38	-36
Ground Soak ^{2/}		43.0	109	<75	37	99

Table 520.5A-III Notes:

¹Uncontrolled humidity (dry as possible).

²Ground soak temperatures are not necessarily related to measured data but are extreme levels to reduce ground soak time.

MIL-STD-810H
METHOD 520.5 ANNEX A

(This page is intentionally blank.)

MIL-STD-810H
METHOD 521.4**METHOD 521.4**
ICING/FREEZING RAIN**CONTENTS**

<u>Paragraph</u>	<u>Page</u>
1. SCOPE	1
1.1 PURPOSE	1
1.2 APPLICATION	1
1.3 LIMITATIONS.....	1
2. TAILORING GUIDANCE	1
2.1 SELECTING THE ICING/FREEZING RAIN METHOD	1
2.1.1 EFFECTS OF ICING/FREEZING RAIN	1
2.1.2 SEQUENCE AMONG OTHER METHODS.....	2
2.2 SELECTING PROCEDURE VARIATIONS	2
2.2.1 ICE FORMATION	2
2.2.1.1 PRINCIPAL CAUSES	2
2.2.1.2 TYPES OF ICE	2
2.2.2 CONFIGURATION AND ORIENTATION	3
2.2.3 TEST TEMPERATURE	3
2.2.4 WATER DELIVERY RATE.....	3
2.2.5 WATER DELIVERY METHOD	3
2.2.6 DROPLET SIZE.....	3
2.2.7 ICE THICKNESS.....	3
2.3 OPERATIONAL CONSIDERATIONS	3
3. INFORMATION REQUIRED.....	4
3.1 PRETEST.....	4
3.2 DURING TEST	4
3.3 POST-TEST	4
4. TEST PROCESS	4
4.1 TEST FACILITY	4
4.2 CONTROLS	4
4.3 TEST INTERRUPTION.....	5
4.3.1 INTERRUPTION DUE TO CHAMBER MALFUNCTION	5
4.3.2 INTERRUPTION DUE TO TEST ITEM OPERATION FAILURE	5
4.4 TEST SETUP.....	5
4.5 TEST EXECUTION	5
4.5.1 PREPARATION FOR TEST.....	5
4.5.1.1 PRELIMINARY STEPS	6
4.5.1.2 PRETEST STANDARD AMBIENT CHECKOUT	6
4.5.2 PROCEDURE - ICE ACCRETION.....	6
5. ANALYSIS OF RESULTS	7
6. REFERENCE/RELATED DOCUMENTS	7
6.1 REFERENCED DOCUMENTS.....	7
6.2 RELATED DOCUMENTS.....	7

MIL-STD-810H
METHOD 521.4

(This page is intentionally blank.)

MIL-STD-810H
METHOD 521.4**METHOD 521.4**
ICING/FREEZING RAIN

NOTE: Tailoring is essential. Select methods, procedures, and parameter levels based on the tailoring process described in Part One, paragraph 4.2.2, and Annex C. Apply the general guidelines for laboratory test methods described in Part One, paragraph 5 of this Standard.

1. SCOPE.**1.1 Purpose.**

The icing test is conducted to evaluate the effect of icing on the operational capability of materiel. This Method also provides tests for evaluating the effectiveness of de-icing equipment and techniques, including prescribed means to be used in the field.

1.2 Application.

- a. Use this Method to evaluate materiel that may be exposed to icing such as produced by freezing rain or freezing drizzle. (See paragraph 2.2.1.1 below.)
- b. Use this Method to develop ice accretion from sea splash or spray but the ice thicknesses may need to be modified to reflect the lower density of the ice.

1.3 Limitations.

This Method does not simulate snow conditions or ice buildup on aircraft flying through supercooled clouds. Though frost occurs naturally, the effects are considered less significant and are not specifically addressed in this Method. This Method may not be suitable for the assessment of aerial/antenna performance, (i.e., rime ice saturated with air causes substantial signal reflection). Also not considered are the icing effects from falling, blowing or re-circulating snow and wet snow or slush. These are considered less severe than those in paragraph 2.1.1.

2. TAILORING GUIDANCE.**2.1 Selecting the Icing/Freezing Rain Method.**

After examining requirements documents and applying the tailoring process in Part One of this Standard to determine where icing/freezing rain is anticipated in the life cycle of materiel, use the following to confirm the need for this Method and to place it in sequence with other methods. This Method is designed to determine if materiel can operate after ice accumulation from rain, drizzle, fog, splash or other sources. When ice removal is required before operation, use integral deicing equipment or expedients normally available to the user in the field. Evaluate deicing equipment and expedients to assess their effectiveness and the potential for damage that may degrade performance.

2.1.1 Effects of Icing/Freezing Rain.

Ice formation can impede materiel operation and survival and affect the safety of operating personnel. Consider the following typical problems to help determine if this Method is appropriate for the materiel being tested. This list is not intended to be all-inclusive.

- a. Binds moving parts together.
- b. Adds weight to radar antennas, aerodynamic control surfaces, helicopter rotors, etc.
- c. Increases footing hazards for personnel.
- d. Interferes with clearances between moving parts.
- e. Induces structural failures.
- f. Reduces airflow efficiency as in cooling systems or filters.
- g. Impedes visibility through windshields and optical devices.
- h. Affects transmission of electromagnetic radiation.

MIL-STD-810H
METHOD 521.4

- i. Provides a source of potential damage to materiel from the employment of mechanical, manual, or chemical ice removal measures.
- j. Reduces efficiency of aerodynamic lifting and control surfaces.
- k. Reduces (aircraft) stall margins.

2.1.2 Sequence Among Other Methods.

- a. General. Use the anticipated life cycle sequence of events as a general sequence guide (see Part One, paragraph 5.5).
- b. Unique to this Method.
 - (1) One approach is to conserve test item life by applying what are perceived to be the least damaging environments first. For this approach, generally apply the icing/freezing rain following rain tests, but prior to salt fog tests, because residual salts could impair the formation of ice. Also, apply this test prior to dynamic tests that could loosen components.
 - (2) Another approach is to apply environments to maximize the likelihood of disclosing synergetic effects. For this approach, subject the test item to the dynamic tests prior to conducting the icing test.

2.2 Selecting Procedure Variations.

This Method has one procedure. However, the test procedure may be varied. Before conducting this test, complete the tailoring process by selecting specific procedure variations (special test conditions/techniques for this procedure) based on requirements documents, Life Cycle Environmental Profile (LCEP), and information provided within this Method. Consider the following in light of the operational purpose and life cycle of the materiel.

2.2.1 Ice Formation.

2.2.1.1 Principal Causes.

A buildup of ice occurs in four principal ways:

- a. From rain, drizzle, or fog falling on materiel whose temperature is at or below freezing.
- b. From sublimation.
- c. From freezing rain or freezing drizzle falling on materiel at or near freezing.
- d. From sea spray and splash that coats materiel when the materiel temperature is below freezing.

2.2.1.2 Types of Ice.

Two types of ice are commonly encountered: rime ice (opaque/granular) and glaze ice (clear/smooth). Published extremes for ice accretion may be used for calculating design and structural evaluations but are not considered practical for establishing test conditions due to the large thicknesses involved unless the test is intended to provide practical confirmation of design calculations.

- a. Rime Ice: A white or milky and opaque granular deposit of ice formed by a rapid freezing of supercooled water drops as they impinge upon an exposed object. Rime ice is lighter, softer, and less transparent than glaze. Rime is composed essentially of discrete ice granules and has densities ranging from 0.2 g/cm³ (soft rime) to almost 0.5 g/cm³ (hard rime). Factors that favor rime formation are small drop size, slow accretion, a high degree of supercooling, and rapid dissipation of latent heat of fusion. The opposite effects favor glaze formation.
 - (1) Hard Rime: Opaque, granular masses of rime deposited chiefly on vertical surfaces by dense, supercooled fog. Hard rime is more compact and amorphous than soft rime, and builds out into the wind as glazed cones or feathers. The icing of ships and shoreline structures by supercooled spray from the sea usually has the characteristics of hard rime.
 - (2) Soft Rime: A white, opaque coating of fine rime deposited chiefly on vertical surfaces, especially on points and edges of objects, generally in supercooled fog. On the windward side, soft rime may grow to very thick layers, long feathery cones, or needles pointing into the wind and having a structure similar to that of frost.

MIL-STD-810H
METHOD 521.4

- b. **Glaze Ice:** A coating of ice, generally clear and smooth but usually containing some air pockets, formed on exposed objects by the freezing of a film of supercooled water vapor. Glaze is denser, harder, and more transparent than rime. Its density may range from 0.6 to 0.9 g/cm³. Factors that favor glaze formation are large drop size, rapid accretion, slight supercooling, and slow dissipation of heat of fusion. The opposite effects favor rime formation. Glaze occurs when rain or drizzle freezes on objects, and is clear and nearly as dense as pure ice. Since glaze ice is more difficult to remove, it is structurally a more significant factor.

2.2.2 Configuration and Orientation.

Consider the following factors:

- a. Whether or not the test item receives icing on all sides and the top.
- b. Whether or not the test item is in its deployment configuration. If required, perform tests in other configurations such as for shipping or outside storage.

2.2.3 Test Temperature.

Test temperatures that may be used to produce the required environmental conditions are recommended in the test procedure. The recommended temperatures of the chamber and water may have to be adjusted for different size facilities to prevent premature freezing of the water droplets before they come in contact with the test item. However, do not use an initial test item temperature below 0 °C (32 °F) to allow water to penetrate (cracks, seams, etc.) prior to freezing.

2.2.4 Water Delivery Rate.

The objective is to produce a clear, uniform coating of glaze ice. Any delivery rate that produces a uniform coating of glaze ice is acceptable. A water delivery rate of 25 mm/h (1 in/h) is suggested in the test procedure and is based on data from previous testing.

2.2.5 Water Delivery Method.

Any of the following water delivery systems can be used as long as the water is delivered as a uniform spray:

- a. Nozzle arrays directing spray to the top, sides, front, and rear of the test item.
- b. Nozzle arrays that direct spray straight down onto the test item. Side-spray coverage is achieved by using wind or an additional hand-held nozzle. Minimize any wind in order to maintain uniform ice accretion.
- c. A single nozzle directing the spray over the appropriate surfaces of the test item.

2.2.6 Droplet Size.

The droplet size range may have to be adjusted for different size facilities. A fine spray in the range of 1.0 mm to 1.5 mm diameter nominal droplet size has produced satisfactory icing in some facilities.

2.2.7 Ice Thickness.

Unless specifically measured data for the anticipated situation are available, the following ice thicknesses are recommended (paragraph 6.1, reference b):

- a. 6 mm (0.24 in) - represents general conditions, light loading.
- b. 13 mm (0.5 in) - represents general conditions, medium loading.
- c. 37 mm (1.5 in) - represents heavy ground loading and marine mast loading.
- d. 75 mm (3 in) - represents extremely heavy ground loading and marine deck loading.

2.3 Operational Considerations.

- a. Some materiel covered with ice may be expected to operate immediately without first undergoing de-icing procedures; other materiel would not be expected to operate until some form of de-icing has taken place (e.g., aircraft ailerons (flaps) prior to flight).
- b. Ice removal, if required, may include built-in ice-removal systems, prescribed means that could be expected to be employed in the field, or a combination of these.

MIL-STD-810H
METHOD 521.4

- c. The correct operation of anti-ice systems such as pre-heated surfaces.

3. INFORMATION REQUIRED.

3.1 Pretest.

The following information is required to conduct icing/freezing rain tests adequately.

- a. General. Information listed in Part One, paragraphs 5.7 and 5.9; and Part One, Annex A, Task 405 of this Standard.
- b. Specific to this Method.
 - (1) Ice thickness to be applied.
 - (2) Ice removal method(s) (if employed).
 - (3) Any variations from recommended test temperatures and droplet sizes.
 - (4) Surfaces of the test item to which ice is to be applied.
 - (5) Velocity of any wind used.
- c. Tailoring. Necessary variations in the basic test procedures to accommodate environments identified in the LCEP.

3.2 During Test.

Collect the following information during conduct of the test:

- a. General. Information listed in Part One, paragraph 5.10, and in Annex A, Tasks 405 and 406 of this Standard.
- b. Specific to this Method.
 - (1) Record of chamber temperatures versus time conditions.
 - (2) Record of the test item temperature-versus-time data for the duration of the test.

3.3 Post-Test.

The following post test data shall be included in the test report.

- a. General. Information listed in Part One, paragraph 5.13, and in Annex A, Task 406 of this Standard.
- b. Specific to this Method.
 - (1) Actual ice thicknesses.
 - (2) Results of required ice removal efforts.
 - (3) Initial analysis of any failures/problems.
 - (4) Type of ice developed, i.e., glaze or rime.
 - (5) Any deviations from the original test plan.

4. TEST PROCESS.

4.1 Test Facility.

The required apparatus consists of a chamber or cabinet together with auxiliary instrumentation capable of establishing and maintaining the specified test conditions. Use a facility equipped so that test conditions within the chamber can be stabilized soon after the test item is installed. Arrange water delivery equipment to minimize the collection of puddles/ice in the chamber. Make continuous recordings of chamber temperature measurements and, if required, test item temperatures.

4.2 Controls.

Before each test, verify the critical parameters. Ensure the nozzle spray pattern is wide enough to guarantee uniform impingement for all test wind velocities. Unless otherwise specified, if any action other than test item operation (such as opening the chamber door) results in a significant change in the test item or chamber temperature (more than 2°C

MIL-STD-810H
METHOD 521.4

(4°F)), restabilize the test item at the required test temperature before continuing. If the operational check is not completed within 15 minutes, reestablish the test item temperature conditions before continuing.

4.3 Test Interruption.

Test interruptions can result from two or more situations, one being from failure or malfunction of test chambers or associated test laboratory equipment. The second type of test interruption results from failure or malfunction of the test item itself during operational checks.

4.3.1 Interruption Due To Chamber Malfunction.

- a. General. See Part One, paragraph 5.11 of this Standard.
- b. Specific to this Method.
 - (1) Undertest interruption. Interruption of an icing/freezing rain test is unlikely to generate any adverse effects. Normally, continue the test from the point of interruption once the test conditions have been re-established.
 - (2) Overtest interruption. Follow any interruption that results in more extreme exposure of the test item than required by the requirements document by a complete operational and physical checkout. If there are no problems, restore the test item to its pretest condition and restart the test.

4.3.2 Interruption Due To Test Item Operation Failure.

Failure of the test item(s) to operate as required during operational checks presents a situation with several possible options.

- a. The preferable option is to replace the test item with a “new” one and restart from Step 1.
- b. A second option is to replace / repair the failed or non-functioning component or assembly with one that operates as intended, and restart the entire test from Step 1.

NOTE: When evaluating failure interruptions, consider prior testing on the same test item and consequences of such.

4.4 Test Setup.

- a. General. See Part One, paragraph 5.8.
- b. Unique to this Method.
 - (1) Clean all outside surfaces of any contamination not present during normal operation. Even thin films of oil or grease will prevent ice from adhering to the test item and change the test results.
 - (2) To facilitate measurement of ice thickness, mount depth gauges such as copper bars or tubes of an appropriate size in places where they will receive the same general water spray as the test item. Other thickness measurement techniques may be used if they can be shown to indicate the ice thickness.

NOTE: Since artificially produced freezing accretion rates tend to depend on the distance between the test item and spray device, for structures with large height variations such as antenna masts, place test bars at different heights.

- (3) Using chilled water (between 0 °C and 3 °C (32 °F and 37 °F)) in the spraying system will cause a faster ice buildup rate than unchilled water.

4.5 Test Execution.

The following steps, alone or in combination, provide the basis for collecting necessary information concerning the materiel in an icing/freezing rain environment.

4.5.1 Preparation for Test.

MIL-STD-810H
METHOD 521.4**4.5.1.1 Preliminary Steps.**

Before starting the test, review pretest information in the test plan to determine test details (e.g., procedures, item configuration, cycles, durations, parameter levels for storage/operation, ice thickness, etc.).

4.5.1.2 Pretest Standard Ambient Checkout.

All items require a pretest standard ambient checkout to provide baseline data. Conduct the checkout as follows:

- Step 1 Install temperature sensors in, on, or around the test item as described in the test plan.
- Step 2 Install the test item in the chamber (Part One, paragraph 5.8.1) in the required configuration and orientation, and at standard ambient conditions (Part One, paragraph 5.1).
- Step 3 Conduct a visual examination of the test item with special attention to stress areas such as corners of molded cases, and document the results.
- Step 4 Conduct an operational checkout (Part One, paragraph 5.8.2) as described in the plan to obtain baseline data, and record the results.
- Step 5 If the test item operates satisfactorily, proceed to paragraph 4.5.2. If not, resolve the problems and repeat Step 4 above.

4.5.2 Procedure - Ice Accretion.

- Step 1 Stabilize the test item temperature at 0 °C (-0/+2 °C (32 °F (-0/+4 °F))).
- Step 2 Deliver a uniform, pre-cooled water spray for 1 hour to allow water penetration into the test item crevices/openings (although a water temperature of 0 to 3 °C (32 to 37 °F) is ideal, a water temperature of 5 °C (41 °F) and a water delivery rate of 25 mm/h (1 in/h) has proven satisfactory).
- Step 3 Adjust the chamber air temperature to -10 °C (14 °F) or as specified, and maintain the water spray rate until the required thickness of ice has accumulated on the appropriate surfaces. Wind or a side spray may be used to assist accumulation of ice on the sides of the test item.

NOTE: If it is difficult to produce a satisfactory layer of glaze ice, vary one or more of the parameters as necessary, i.e., water or test item temperature, spray rate or duration, distance between the nozzles and the test item, etc. Generally an air temperature no warmer than -2 C (28°F) is more likely to produce glaze ice.

NOTE: It may be easier to stop spraying during the temperature reduction to facilitate temperature adjustment and to minimize frosting of test chamber refrigeration coils.

- Step 4 Maintain the chamber air temperature for a minimum of 4 hours to allow the ice to harden. Examine for safety hazards and, if appropriate, attempt to operate the test item. Document the results (with photographs if necessary).
- Step 5 If Step 4 resulted in failure, or if the specification requires or allows ice removal, remove the ice. Limit the method of ice removal to that determined in paragraph 3.1b, e.g., built-in ice removal systems, plus expedient means that could be expected to be employed in the field. Note the effectiveness of ice removal techniques used. Examine for safety hazards and, if appropriate (and possible), attempt to operate the test item. If the test item fails to operate as intended, follow the guidance in paragraph 4.3.2 for test item failure.

MIL-STD-810H
METHOD 521.4

- Step 6 Examine for safety hazards and, if appropriate (and possible), attempt to operate the test item at the specified low operating temperature of the materiel. If the test item fails to operate as intended, follow the guidance in paragraph 4.3.2 for test item failure.
- Step 7 If required, repeat Steps 3 through 6 to produce other required thicknesses of ice.
- Step 8 Stabilize the test item at standard ambient conditions and perform a post-test operational check. See paragraph 5 for analysis of results.
- Step 9 Document (with photographs if necessary) the results for comparison with pretest data.

5. ANALYSIS OF RESULTS.

In addition to the guidance provided in Part One, paragraphs 5.14 and 5.17, the following information is provided to assist in the evaluation of the test results. Apply any data relative to failure of a test item to the test analysis, and consider related information such as:

- a. For materiel that must operate without ice removal: If the performance of the test item has been degraded beyond that specified in the requirements document.
- b. For materiel that requires ice removal before operation: If the performance of the test item has been degraded below the specified limits/requirements after normal ice removal efforts have been undertaken.
- c. If normal ice removal damages the materiel.
- d. If a non-apparent hazardous situation has been created.

6. REFERENCE/RELATED DOCUMENTS.

6.1 Referenced Documents.

- a. Glossary of Meteorology, Edited by Ralph E. Huschke, Published by the American Meteorological Society (1959); Air Force Institute of Technology Library.
- b. Letter, Cold Regions Research and Engineering Laboratory, Corps of Engineers (U.S.), CECRL-RG, 22 October 1990, SUBJECT: Ice Accretion Rates (Glaze).

6.2 Related Documents.

- a. AR 70-38, Research, Development, Test and Evaluation of Materiel for Extreme Climatic Conditions.
- b. MIL-HDBK-310, Global Climatic Data for Developing Military Products.
- c. Synopsis of Background Material for MIL-STD-210B, Climatic Extremes for Military Equipment. Bedford, MA: Air Force Cambridge Research Laboratories, 24 January 1974. DTIC number AD-780-508.
- d. NATO STANAG 4370, Environmental Testing.
- e. Allied Environmental Conditions and Test Publication (AECTP) 300, Climatic Environmental Tests (under STANAG 4370), Method 311.
- f. Egbert, Herbert W. "The History and Rationale of MIL-STD-810 (Edition 2)," January 2010; Institute of Environmental Sciences and Technology, Arlington Place One, 2340 S. Arlington Heights Road, Suite 100, Arlington Heights, IL 60005-4516.
- g. Bennett, Ivan. (1959). Glaze: Its Meteorology and Climatology, Geographic Distribution and Economic Effects (Technical Report EP-105). Natick, MA: Quartermaster Research and Engineering Center.
- h. Tattelman, Paul and Gringorton, Irving. (1973). Estimate Glaze Ice and Wind Loads at the Earth's Surface for the Contiguous United States. AFCRL, Hanscom AFB, MA.
- i. Burt, Chris. Extreme Weather (2004), NY: W.W. Norton and Co.
- j. Ludlam, David. The American Weather Book (1982), NY: Houghton Mifflin Co.
- k. Sanderson, J. (1973). Occurrence of Ice in the Form of Glaze, Rime, and Hoarfrost with respect to the Operation and Storage of V/STOL Aircraft (ETL-DR-73-1), US Army ETL, Fort Belvoir, VA.

MIL-STD-810H
METHOD 521.4

(Copies of Department of Defense Specifications, Standards, and Handbooks, and International Standardization Agreements are available online at <https://assist.dla.mil>.)

Requests for other defense-related technical publications may be directed to the Defense Technical Information Center (DTIC), ATTN: DTIC-BR, Suite 0944, 8725 John J. Kingman Road, Fort Belvoir VA 22060-6218, 1-800-225-3842 (Assistance--selection 3, option 2), <http://www.dtic.mil/dtic/>; and the National Technical Information Service (NTIS), Springfield VA 22161, 1-800-553-NTIS (6847), <http://www.ntis.gov/>.

MIL-STD-810H
METHOD 522.2**METHOD 522.2**
BALLISTIC SHOCK**CONTENTS**

<u>Paragraph</u>	<u>Page</u>
1. SCOPE	1
1.1 PURPOSE	1
1.2 APPLICATION	1
1.2.1 BALLISTIC SHOCK DEFINITION.....	1
1.2.2 BALLISTIC SHOCK - MOMENTUM EXCHANGE	1
1.2.3 BALLISTIC SHOCK - PHYSICAL PHENOMENON.....	2
1.3 LIMITATIONS.....	2
2. TAILORING GUIDANCE.....	3
2.1 SELECTING THE BALLISTIC SHOCK METHOD	3
2.1.1 EFFECTS OF BALLISTIC SHOCK.....	3
2.1.2 SEQUENCE AMONG OTHER METHODS.....	3
2.2 SELECTING A PROCEDURE.....	3
2.2.1 PROCEDURE SELECTION CONSIDERATIONS	5
2.2.2 DIFFERENCE AMONG PROCEDURES.....	6
2.2.2.1 PROCEDURE I - BH&T	6
2.2.2.2 PROCEDURE II - LSBSS	6
2.2.2.3 PROCEDURE III - LWSM.....	6
2.2.2.4 PROCEDURE IV - MECHANICAL SHOCK SIMULATOR.....	6
2.2.2.5 PROCEDURE V - MWSM.....	6
2.2.2.6 PROCEDURE VI - DROP TABLE.....	6
2.3 DETERMINE TEST LEVELS AND CONDITIONS	6
2.3.1 GENERAL CONSIDERATIONS - TERMINOLOGY	7
2.3.2 TEST CONDITIONS - SHOCK SPECTRUM TRANSIENT DURATION AND SCALING	7
2.3.2.1 MEASURED DATA AVAILABLE FROM BALLISTIC SHOCK.....	7
2.3.2.2 MEASURED DATA NOT AVAILABLE FROM BALLISTIC SHOCK	8
2.3.3 BALLISTIC SHOCK QUALIFICATION - PROCEDURE I.....	8
2.3.4 BALLISTIC SHOCK QUALIFICATION - PROCEDURES II THROUGH VI.....	8
2.4 TEST ITEM CONFIGURATION	9
3. INFORMATION REQUIRED.....	9
3.1 PRETEST.....	9
3.2 DURING TEST.....	9
3.3 POST-TEST	9
4. TEST PROCESS	10
4.1 TEST FACILITY	10
4.2 CONTROLS	10
4.3 TEST INTERRUPTION	11
4.3.1 INTERRUPTION DUE TO TEST EQUIPMENT MALFUNCTION.....	11
4.3.2 INTERRUPTION DUE TO TEST ITEM OPERATION FAILURE	11
4.4 INSTRUMENTATION.....	11
4.4.1 BALLISTIC SHOCK MEASUREMENT TRANSDUCERS	11
4.4.2 DATA ACQUISITION INSTRUMENTATION	12
4.4.2.1 FILTERING AND FREQUENCY RESPONSE.....	12

MIL-STD-810H
METHOD 522.2

CONTENTS - Continued

<u>Paragraph</u>	<u>Page</u>
4.4.2.2 SLEW RATE	14
4.4.2.3 HEADROOM.....	14
4.5 DATA ANALYSIS	15
4.6 TEST EXECUTION	15
4.6.1 PREPARATION FOR TEST.....	15
4.6.1.1 PRELIMINARY STEPS	15
4.6.1.2 PRETEST CHECKOUT	15
4.6.2 PROCEDURES.....	16
4.6.2.1 PROCEDURE I - BH&T	16
4.6.2.2 PROCEDURE II - LSBSS	16
4.6.2.3 PROCEDURE III - LWSM.....	16
4.6.2.4 PROCEDURE IV - MECHANICAL SHOCK SIMULATOR.....	17
4.6.2.5 PROCEDURE V - MWSM.....	17
4.6.2.6 PROCEDURE VI - DROP TABLE.....	18
5. ANALYSIS OF RESULTS	18
6. REFERENCE/RELATED DOCUMENTS	18
6.1 REFERENCED DOCUMENTS.....	18
6.2 RELATED DOCUMENTS.....	18

TABLES

TABLE 522.2-I. BALLISTIC SHOCK CHARACTERISTICS	4
TABLE 522.2-II. SRS FUNCTION FOR SHOCK.....	9

FIGURES

FIGURE 522.2 -1. SHOCK RESPONSE SPECTRA OF “DEFAULT” BALLISTIC SHOCK LIMITS (TABLES 522.2-I & II).....	4
FIGURE 522.2 -2. SHOCK RESPONSE SPECTRA FROM THREE DIFFERENT SENSORS NEEDED TO MEASURE THE ENTIRE SPECTRUM (5 Hz TO 100,000 Hz) OF A BALLISTIC SHOCK EVENT	12
FIGURE 522.2 -3. FILTER ATTENUATION (CONCEPTUAL, NOT FILTER SPECIFIC)	13
FIGURE 522.2 -4. ILLUSTRATION OF SAMPLING RATES AND OUT OF BAND “FOLD OVER” FREQUENCIES FOR DATA ACQUISITION SYSTEMS	14

MIL-STD-810H
METHOD 522.2**METHOD 522.2**
BALLISTIC SHOCK

NOTE: Tailoring is essential. Select methods, procedures, and parameter levels based on the tailoring process described in Part One, paragraph 4.2.2, and Annex C. Apply the general guidelines for laboratory test methods described in Part One, paragraph 5 of this Standard.

1. SCOPE.**1.1 Purpose.**

This Method includes a set of ballistic shock tests generally involving momentum exchange between two or more bodies, or momentum exchange between a liquid or gas and a solid performed to:

- a. Provide a degree of confidence that materiel can structurally and functionally withstand the infrequent shock effects caused by high levels of momentum exchange on a structural configuration to which the materiel is mounted.
- b. Experimentally estimate the materiel's fragility level relative to ballistic shock in order that shock mitigation procedures may be employed to protect the materiel's structural and functional integrity.

1.2 Application.**1.2.1 Ballistic Shock Definition.**

Ballistic shock is a high-level shock that generally results from the impact of projectiles or ordnance on armored combat vehicles. Armored combat vehicles must survive the shocks resulting from large caliber non-perforating projectile impacts, mine blasts, and overhead artillery attacks, while still retaining their combat mission capabilities. Paragraph 6.1, reference a, discusses the relationship between various shock environments (ballistic shock, transportation shock, rail impact shock, etc.) for armored combat vehicles. Actual shock levels vary with the type of vehicle, the specific munition used, the impact location or proximity, and where on the vehicle the shock is measured. There is no intent here to define the actual shock environment for specific vehicles. Furthermore, it should be noted that the ballistic shock technology is still rather limited in its ability to define and quantify the actual shock phenomenon. Even though considerable progress has been made in the development of measurement techniques, currently used instrumentation (especially the shock sensing gages) is still bulky and cumbersome to use. The development of analytical (computational) methods to determine shock levels, shock propagation, and mitigation is lagging behind the measurement technology. The analytical methods under development and in use to date have not evolved to the level where their results can be relied upon to the degree that the need for testing is eliminated. That is, the prediction of response to ballistic shock is, in general, not possible except in the simplest configurations. When an armored vehicle is subjected to a non-perforating large caliber munition impact or blast, the structure locally experiences a force loading of very high intensity and of relatively short duration. Though the force loading is localized, the entire vehicle is subjected to stress waves traveling over the surface and through the structure. In certain cases, pyrotechnic shocks have been used in ballistic shock simulations. There are several caveats in such testing. The characteristics of ballistic shock are outlined in the following paragraph.

1.2.2 Ballistic Shock - Momentum Exchange.

Ballistic shock usually exhibits momentum exchange between two bodies or between a fluid and a solid. It commonly results in velocity change in the support materiel. Ballistic shock has a portion of its characterization below 100 Hz, and the magnitude of the ballistic shock response at a given point reasonably far from the ballistic shock source is a function of the size of the momentum exchange. Ballistic shock will contain material wave propagation characteristics (perhaps substantially nonlinear) but, in general, the material is deformed and accompanied by structural damping other than damping natural to the material. For ballistic shock, structural connections do not necessarily display great attenuation since low frequency structural response is generally easily transmitted over joints. In processing ballistic shock data, it is important to be able to detect anomalies. With regard to measurement technology, accelerometers, strain gages, and shock sensing gages may be used (see paragraph 6.1, reference a). In laboratory situations, laser velocimeters are useful. Ballistic shock resistance is not, in general, "designed" into the materiel. The occurrence of

MIL-STD-810H
METHOD 522.2

a ballistic shock and its general nature can only be determined empirically from past experience based on well-defined scenarios. Ballistic shock response of materiel in the field is, in general, very unpredictable and not repeatable among materiel.

1.2.3 Ballistic Shock - Physical Phenomenon.

Ballistic shock is a physical phenomenon characterized by the overall material and mechanical response at a structure point from elastic or inelastic impact. Such impact may produce a very high rate of momentum exchange at a point, over a small finite area or over a large area. The high rate of momentum exchange may be caused by collision of two elastic bodies or a pressure wave applied over a surface. General characteristics of ballistic shock environments are as follows:

- a. Near-the-source stress waves in the structure caused by high material strain rates (nonlinear material region) that propagate into the near field and beyond.
- b. Combined low and high frequency (10 Hz – 1,000,000 Hz) and very broadband frequency input.
- c. High acceleration (300 g's – 1,000,000 g's) with comparatively high structural velocity and displacement response.
- d. Short-time duration (<180 msec).
- e. High residual structure displacement, velocity, and acceleration response (after the event).
- f. Caused by (1) an inelastic collision of two elastic bodies, or (2) an extremely high fluid pressure applied for a short period of time to an elastic body surface coupled directly into the structure, and with point source input, i.e., input is either highly localized as in the case of collision, or area source input, i.e., widely dispersed as in the case of a pressure wave.
- g. Comparatively high structural driving point impedance (P/v , where P is the collision force or pressure, and v is the structural velocity). At the source, the impedance could be substantially less if the material particle velocity is high.
- h. Measurement response time histories that are very highly random in nature, i.e., little repeatability and very dependent on the configuration details.
- i. Shock response at points on the structure is somewhat affected by structural discontinuities.
- j. Structural response may be accompanied by heat generated by the inelastic impact or the fluid blast wave.
- k. The nature of the structural response to ballistic shock does not suggest that the materiel or its components may be easily classified as being in the "near field" or "far field" of the ballistic shock device. In general, materiel close to the source experiences high accelerations at high frequencies, whereas materiel far from the source will, in general, experience high acceleration at low frequencies as a result of the filtering of the intervening structural configuration.

1.3 Limitations.

Because of the highly specialized nature of ballistic shock and the substantial sensitivity of ballistic shock to the configuration, apply it only after giving careful consideration to information contained in paragraph 6.1, references a and b.

- a. This Method does not include special provisions for performing ballistic shock tests at high or low temperatures. Perform tests at room ambient temperature unless otherwise specified or if there is reason to believe either operational high temperature or low temperature may enhance the ballistic shock environment.
- b. This Method does not address secondary effects such as blast, EMI, and thermal.

MIL-STD-810H
METHOD 522.2

2. TAILORING GUIDANCE.

2.1 Selecting the Ballistic Shock Method.

After examining requirements documents and applying the tailoring process in Part One of this Standard to determine where ballistic shock effects are foreseen in the life cycle of the materiel, use the following to confirm the need for this Method and to place it in sequence with other methods.

2.1.1 Effects of Ballistic Shock.

In general, ballistic shock has the potential for producing adverse effects on all electronic, mechanical, and electro-mechanical systems. In general, the level of adverse effects increases with the level and duration of the ballistic shock, and decreases with the distance from the source (point or points of impact) of the ballistic shock. Durations for ballistic shock that produce material stress waves with wavelengths that correspond with the natural frequency wavelengths of micro electronic components within various system components will enhance adverse effects. Durations for ballistic shock that produce structure response movement that correspond with the low frequency resonances of mechanical and electro-mechanical systems will enhance the adverse effects. Examples of problems associated with ballistic shock include:

- a. System failure as a result of destruction of the structural integrity of micro electronic chips including their mounting configuration.
- b. System component failure as a result of relay chatter.
- c. System component failure as a result of circuit card malfunction, circuit card damage, and electronic connector failure. On occasion, circuit card contaminants having the potential to cause short circuits may be dislodged under ballistic shock. Circuit card mounts may be subject to damage from substantial velocity changes and large displacements.
- d. Material failure as a result of cracks and fracture in crystals, ceramics, epoxies or glass envelopes.
- e. System component failure as a result of sudden velocity change of the structural support of the system component, or the internal structural configuration of the mechanical or electro-mechanical system.

2.1.2 Sequence Among Other Methods.

- a. General. Use the anticipated life cycle sequence of events as a general sequence guide (see Part One, paragraph 5.5).
- b. Unique to this Method. Unless otherwise identified in the life cycle profile and, since ballistic shock is normally experienced in combat and potentially near the end of the life cycle, normally schedule ballistic shock tests late in the test sequence. In general, the ballistic shock tests can be considered independent of the other tests because of their unique and specialized nature.

2.2 Selecting a Procedure.

This Method includes six ballistic shock test procedures. See paragraph 2.3.4 for the “default” approach to ballistic shock testing when no field data are available.

- a. Procedure I - Ballistic Hull and Turret (BH&T), Full Spectrum, Ballistic Shock Qualification. Replication of the shock associated with ballistic impacts on armored vehicles can be accomplished by firing projectiles at a “Ballistic Hull and Turret” (BH&T) with the materiel mounted inside. This procedure is very expensive and requires that an actual vehicle or prototype be available, as well as appropriate threat munitions. Because of these limitations, a variety of other approaches is often pursued. The variety of devices used to simulate ballistic shock is described in paragraph 6.1, reference a.
- b. Procedure II - Large Scale Ballistic Shock Simulator (LSBSS). Ballistic shock testing of complete components over the entire spectrum (10 Hz to 100 kHz) defined in Table 522.2-I and in Figure 522.2-1 can be accomplished using devices such as the Large Scale Ballistic Shock Simulator (LSBSS) described in paragraph 6.1, reference a. This approach is used for components weighing up to 500 Kg (1100 lbs), and is considerably less expensive than the BH&T approach of Procedure I.
- c. Procedure III - Limited Spectrum, Light Weight Shock Machine (LWSM). Components weighing less than 113.6 kg (250 lb) and shock mounted to eliminate sensitivity to frequencies above 3 kHz can be tested over

MIL-STD-810H
METHOD 522.2

the spectrum from 10 Hz to 3 kHz of Table 522.2-I and Figure 522.2-1 using a MIL-S-901 Light Weight Shock Machine (LWSM) (paragraph 6.1, reference c) adjusted for 15 mm (0.59 inch) displacement limits. Use of the LWSM is less expensive than full spectrum simulation, and may be appropriate if the specific test item does not respond to high frequency shock and cannot withstand the excessive low frequency response of the drop table (Procedure V).

Table 522.2-I. Ballistic shock characteristics.

Average (Default) Shock				Worst Case Shock		
Max. Resonant Freq. (Hz) ²	Peak Displacement (mm (in))	Peak Velocity (m/s (ft/sec))	Peak Value of SRS ¹ (g's)	Peak Displacement (mm (in))	Peak Velocity (m/s (ft/sec))	Peak Value of SRS ¹ (g's)
10	15 (0.59)	1.0 (3.3)	6.0	42 (1.7)	2.8 (9.2)	17
29.5	15 (0.59)	3.0 (10)	52.5	42 (1.7)	8.5 (28)	148
100	15 (0.59)	3.0 (10)	178	42 (1.7)	8.5 (28)	502
1,000	15 (0.59)	3.0 (10)	1,780	42 (1.7)	8.5 (28)	5,020
10,000	15 (0.59)	3.0 (10)	17,800	42 (1.7)	8.5 (28)	50,200
100,000	15 (0.59)	3.0 (10)	178,000	42 (1.7)	8.5 (28)	502,000

¹ SRS (Shock Response Spectrum) is Equivalent Static Acceleration for a damping ratio equal to 5 percent of critical.

² Tests involving all frequencies from 10 Hz to maximum frequency indicated.

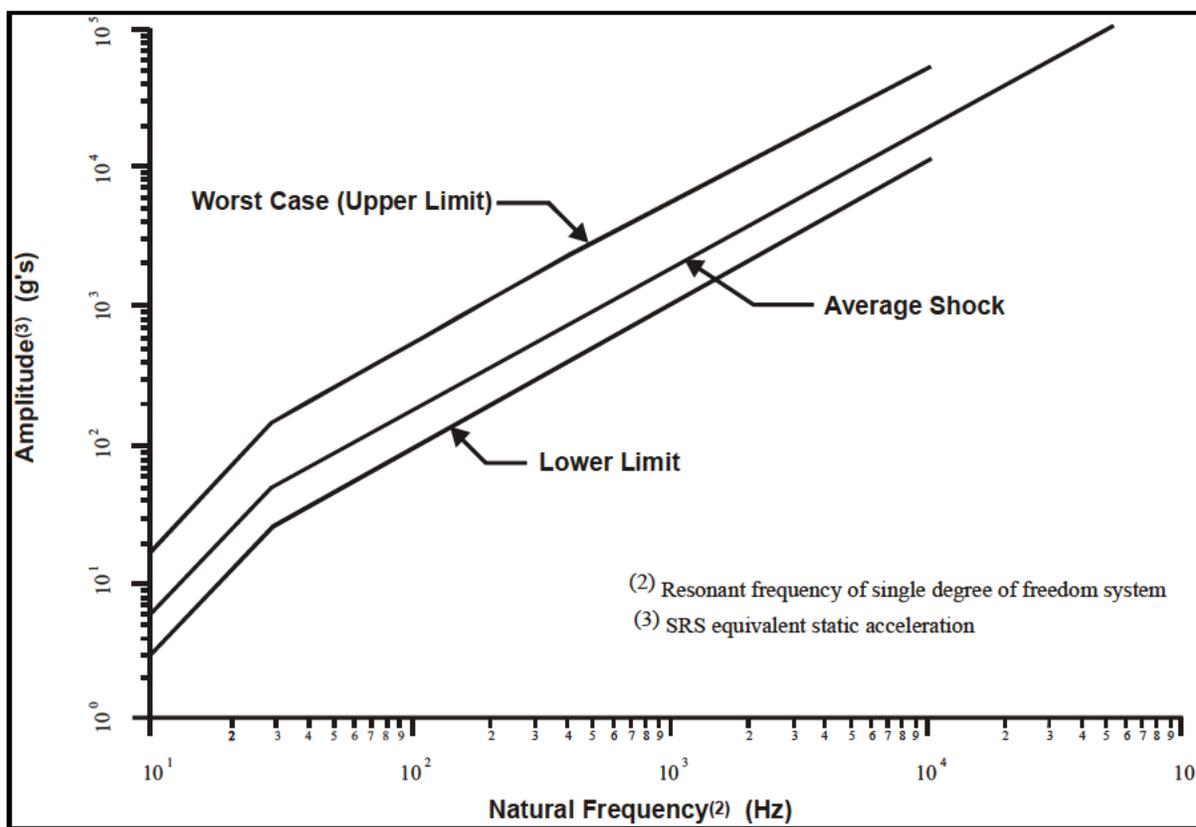


Figure 522.2-1. Shock response spectra of "default" ballistic shock limits (Tables 522.2-I & II).

- d. Procedure IV - Limited Spectrum. Mechanical Shock Simulator. Mechanical shock simulators have been constructed to test very light weight components (0.5 to 1.8 kg (1 to 4 lb) for the smallest machine; higher

MIL-STD-810H
METHOD 522.2

for other contractor machines). These machines produce a shock that lies within the envelope of the default shock response spectrum described in paragraph 2.3.4 up to 10 kHz. Shock content is present above 10 kHz, but it is not well defined. Use of a Mechanical Shock Simulator is less expensive than full spectrum simulation, and may be appropriate for light weight items that are sensitive to shock up to 10 kHz.

- e. Procedure V - Limited Spectrum, Medium Weight Shock Machine (MWSM). Components weighing less than 2273 kg (5000 lb) and not sensitive to frequencies above 1 kHz can be tested over the spectrum from 10 Hz to 1 kHz of Table 522.2-I and Figure 522.2-1 using a MIL-S-901 Medium Weight Shock Machine (MWSM) (paragraph 6.1, reference c) adjusted for 15 mm (0.59 in.) displacement limits. Use of the MWSM may be appropriate for heavy components and subsystems that are shock mounted and/or are not sensitive to high frequencies.
- f. Procedure VI - Drop Table. Light weight components (typically less than 18 kg (40 lbs)) which are shock mounted can often be evaluated for ballistic shock sensitivity at frequencies up to 500 Hz using a drop table. This technique often results in overttest at the low frequencies. The vast majority of components that need shock protection on an armored vehicle can be readily shock mounted. The commonly available drop test machine is the least expensive and most accessible test technique. The shock table produces a half-sine acceleration pulse that differs significantly from ballistic shock. The response of materiel on shock mounts can be enveloped quite well with a half-sine acceleration pulse if an overttest at low frequencies and an underttest at high frequencies is acceptable. Historically, these shortcomings have been acceptable for the majority of ballistic shock qualification testing.

NOTES: Related Shock Tests:

1. High Impact / Shipboard Equipment. Perform shock tests for shipboard equipment in accordance with MIL-S-901. The tests of MIL-S-901 are tailorable through the design of the fixture that attaches the test item to the shock machine. Ensure the fixture is as similar to the mounting method used in the actual use environment. High impact shocks for Army armored combat vehicles should be tested using this Method.
2. Fuzes and Fuze Components. Perform shock tests for safety and operation of fuzes and fuze components in accordance with MIL-STD-331 (paragraph 6.1, reference d).
3. Combined Temperature and Shock Tests. Perform shock tests at standard ambient conditions (Part One, paragraph 5.1a) unless a high or low temperature shock test is required.

2.2.1 Procedure Selection Considerations.

Based on the test data requirements, determine which test procedure is applicable. In most cases, the selection of the procedure will be dictated by the actual materiel configuration, carefully noting any gross structural discontinuities that may serve to mitigate the effects of the ballistic shock on the materiel. In some cases, the selection of the procedure will be driven by test practicality. Consider all ballistic shock environments anticipated for the materiel during its life cycle, both in its logistic and operational modes. When selecting procedures, consider:

- a. The Operational Purpose of the Materiel. From the requirements documents, determine the functions to be performed by the materiel either during or after exposure to the ballistic shock environment.
- b. The Natural Exposure Circumstances for Ballistic Shock. The natural exposure circumstances for ballistic shock are based on well-selected scenarios from past experience and the chances of the occurrence of such scenarios. For example, if an armored vehicle is subject to a mine blast, a number of assumptions must be made in order to select an appropriate test for the ballistic shock procedure. In particular, the size of the mine, the location of major pressure wave impact, the location of the materiel relative to the impact "point," etc. If the armored vehicle is subject to non-penetrating projectile impact, the energy input configuration will be different from that of the mine, as will be the effects of the ballistic shock on the materiel within the armored vehicle. In any case, condition each scenario to estimate the materiel response as a function of amplitude level and frequency content. It will then be necessary to decide to which scenarios to test and which testing is most critical. Some scenario responses may "envelope" others, which may reduce the need

MIL-STD-810H
METHOD 522.2

for certain testing such as road, rail, gunfiring, etc. In test planning, do not break up any measured or predicted response to ballistic shock into separate amplitude and/or frequency ranges using different tests to satisfy one procedure.

- c. Required Data. The test data required to determine whether the operational purpose of the materiel has been met.
- d. Procedure Sequence. Refer to paragraph 2.1.2.

2.2.2 Difference Among Procedures.

2.2.2.1 Procedure I - BH&T.

Ballistic shock is applied in its natural form using live fire testing. Test items are mounted in the BH&T that replicates the full-size vehicle in its “as designed” configuration and location. If required, “upweight” the vehicle to achieve proper dynamic response. Appropriate threats (type, distance, orientation) are successively fired at the hull and/or turret. This procedure is used to evaluate the operation of actual components, or the interaction between various components during actual ballistic impacts. Also, this procedure is used to determine actual shock levels for one particular engagement, that may be above or below the ‘default’ shock level specified in Table 522.2-I.

2.2.2.2 Procedure II - LSBSS.

LSBSS is a low cost option for producing the spectrum of ballistic shock without the expense of live fire testing. This procedure is used primarily to test large, hard mounted components at the ‘default’ shock level specified in Table 522.2-I. It produces shock over the entire spectrum (10 Hz to over 100,000 Hz), and is useful in evaluating components of unknown shock sensitivity.

2.2.2.3 Procedure III - LWSM.

Ballistic shock is simulated using a hammer impact. The test item is mounted on an anvil table of the shock machine using the test item’s tactical mount. The anvil table receives the direct hammer impact that replicates the lower frequencies of general threats to a hull or turret. This procedure is used to test shock mounted components (up to 113.6 kg (250 lb)), which are known to be insensitive to the higher frequency content of ballistic shock. This procedure produces ‘partial spectrum’ testing (up to 3,000 Hz) at the ‘default’ level specified in Table 522.2-I.

2.2.2.4 Procedure IV - Mechanical Shock Simulator.

Ballistic shock is simulated using a metal-to-metal impact (gas driven projectile). The test item is mounted on a plate of the shock machine using the test item’s tactical mount. This procedure is used to test small components (1.8 kg (4 lb)) for the smallest machine; higher weight for other contractor machines), that are known to be insensitive to the highest frequency content of ballistic shock. This procedure produces ‘partial spectrum’ testing (up to 10,000 Hz) at the ‘default’ level specified in Table 522.2-I.

2.2.2.5 Procedure V - MWSM.

Ballistic shock is simulated using a hammer impact. The test item is mounted on the anvil table of the shock machine using the test item’s tactical mount. The anvil table receives the direct hammer impact, which replicates the lower frequencies of general threats to a hull or turret. This procedure is used to test components up to 2273 kg (5000 lb) in weight which are known to be insensitive to the higher frequencies of ballistic shock. This procedure produces ‘partial spectrum’ testing (up to 1,000 Hz.) at the ‘default’ level specified in Table 522.2-I.

2.2.2.6 Procedure VI - Drop Table.

Ballistic shock is simulated by the impact resulting from a drop. The test item is mounted on the table of a commercial drop machine using the test item’s tactical mounts. The table and test item are dropped from a calculated height. The table receives the direct blow at the impact surface, which approximates the lower frequencies of general threat to a hull or turret. This procedure is used for ‘partial spectrum’ testing of shock mounted components that can withstand an overtest at low frequencies.

2.3 Determine Test Levels and Conditions.

Having selected one of the six ballistic shock procedures (based on the materiel’s requirements documents and the tailoring process), complete the tailoring process by identifying appropriate parameter levels, applicable test conditions and applicable test techniques for that procedure. Exercise extreme care in consideration of the details in

MIL-STD-810H
METHOD 522.2

the tailoring process. Base these selections on the requirements documents, the Life Cycle Environmental Profile (LCEP), and information provided with this method. Consider the following basic information when selecting test levels.

2.3.1 General Considerations - Terminology.

In general, response acceleration will be the experimental variable of measurement for ballistic shock. However, this does not preclude other variables of measurement such as velocity, displacement, or strain from being measured and processed in an analogous manner, as long as the interpretation, capabilities, and limitations of the measurement variable are clear. Pay particular attention to the high frequency environment generated by the ballistic attack, as well as the capabilities of the measurement system to accurately record the materiel's responses. For the purpose of this method, the terms that follow will be helpful in the discussion relative to analysis of response measurements from ballistic shock testing.

- a. Effective transient duration: The "effective transient duration" is the minimum length of time which contains all significant amplitude time history magnitudes beginning at the noise floor of the instrumentation system just prior to the initial pulse, and proceeding to the point that the amplitude time history is a combination of measurement noise and substantially decayed structural response. In general, an experienced analyst is required to determine the pertinent measurement duration to define the ballistic shock event. The longer the duration of the ballistic shock, the more low frequency information is preserved. The amplitude time history magnitude may be decomposed into several "shocks" with different effective transient durations if it appears that the overall time history trace contains several independent "shock-like" events in which there are decay to near noise floor of the instrumentation system between events. Each event may be considered a separate shock.
- b. Shock response spectrum analysis: Paragraph 6.1, reference e, defines the equivalent static acceleration maximax Shock Response Spectrum (SRS) and provides examples of SRS computed for classical pulses. The SRS value at a given undamped natural oscillator frequency, f_n , is defined to be the absolute value of the maximum of the positive and negative acceleration responses of a mass for a given base input to a damped single degree of freedom system. The base input is the measured shock amplitude time history over a specified duration (the specified duration should be the effective transient duration). To some extent, for processing of ballistic shock response data, the equivalent static acceleration maximax SRS has become the primary analysis descriptor. In this measurement description, the maximax equivalent static acceleration values are plotted on the ordinate with the undamped natural frequency of the single degree of freedom system with base input plotted along the abscissa. Interpret the phrase "equivalent static acceleration" literally only for rigid lightweight components on isolation mounts.

2.3.2 Test Conditions – Shock Spectrum Transient Duration and Scaling.

Derive the SRS and the effective transient duration, T , from measurements of the materiel's response to a ballistic shock environment or, if available, from dynamically scaled measurements of a similar environment. Because of the inherent very high degree of randomness associated with the response to a ballistic shock, extreme care must be exercised in dynamically scaling a similar environment. For ballistic shock, there are no known scaling laws because of the sensitivity of the response to the size of the shock and the general configuration.

2.3.2.1 Measured Data Available From Ballistic Shock.

- a. If measured data are available, the data may be processed utilizing the SRS. (The use of Fourier Spectra (FS) or the Energy Spectral Density (ESD) is not recommended, but may be of interest in special cases.) For engineering and historical purposes, the SRS has become the standard for measured data processing. In the discussion to follow, it will be assumed that the SRS is the processing tool. In general, the maximax SRS spectrum (equivalent static acceleration) is the main quantity of interest. With this background, determine the shock response spectrum required for the test from analysis of the measured environmental acceleration time history. After carefully qualifying the data, to make certain there are no anomalies in the amplitude time histories, according to the recommendations provided in paragraph 6.1, reference f, compute the SRS. The analyses will be performed for $Q = 10$ at a sequence of natural frequencies at intervals of at least 1/12th octave spacing to span a frequency range consistent with the objective of the procedure.
- b. Because sufficient field data are rarely available for statistical analysis, an increase over the envelope of the available spectral data is sometimes used to establish the required test spectrum to account for variability of

MIL-STD-810H
METHOD 522.2

the environment. The degree of increase is based upon engineering judgment and should be supported by rationale for that judgment. In these cases, it is often convenient to envelope the SRS by computing the maximax spectra over the sample spectra and proceed to add a +6 dB margin to the SRS maximax envelope.

NOTE: This approach does not apply to the default values in Table 522.2-I.

2.3.2.2 Measured Data Not Available From Ballistic Shock.

If a data base is not available for a particular configuration, use (carefully) configuration similarity and any associated measured data for prescribing a ballistic shock test. Because of the sensitivity of the ballistic shock to the system configuration and the wide variability inherent in ballistic shock measurements, use caution in determining levels. Table 522.2-I and Figure 522.2-1 give 'default' values for expected ballistic shock levels when no field measurement results are available.

2.3.3 Ballistic Shock Qualification – Procedure I.

Ballistic Shock Qualification - Procedure I is different from the other ballistic shock methods in that the shock levels are unknown until each particular shot (threat munition, attack angle, impact point, armor configuration, etc.) has been fired and measurements have been made. The shock levels are determined by the interaction of the threat munition and the armor as well as by the structure of the vehicle. Although the levels cannot be specified in advance, this technique produces the most realistic shock levels.

2.3.4 Ballistic Shock Qualification – Procedures II Through VI.

For Ballistic Shock Procedures II through VI, subject the test item to the appropriate ballistic shock level a minimum of three times in the axis of orientation of greatest shock sensitivity (i.e., the worst direction). Perform an operational verification of the component during/after each test. For frequencies above 1 kHz, many ballistic shock events produce similar shock levels in all three axes. If shock levels are known from previous measurements, the shock testing can be tailored appropriately. If shock measurements are not available, use Steps a-g as outlined below.

- a. Ensure the test item remains in place and that it continues to operate during and following shocks that are at or below the average shock level specified in Table 522.2-I. The test item must also remain in place and continue to operate following shocks that are at or below the worst case shock level specified in Table 522.2-I. Ensure materiel critical to crew survival (e.g., fire suppression systems) continues to operate during and following the worst case shock.
- b. Mount the transducers used to measure the shock on the structure as near as possible to the structure mount. Take triaxial measurements at this location. If triaxial measurements are not practical, make as many uniaxial measurements as is practical.
- c. Analyze the shock measurements in the time domain, as well as the frequency domain. Calculate the SRS using a damping ratio of 5 percent of critical damping ($Q = 10$); calculate the SRS using at least 12 frequencies per octave, proportionally spaced in the region from 10 Hz to 10 kHz (e.g., 120 frequencies spaced at approximately 10, 10.59, 11.22, 11.89, 12.59, ..., 8414, 8913, 9441, 10,000 Hz).
- d. For a test shock to be considered an acceptable simulation of the requirement, 90 percent of the points in the region from 10 Hz to 10 kHz must fall within the bounds listed in Table 522.2-II.
- e. If more than 10 percent of the SRS points in the region from 10 Hz to 10 kHz are above the upper bound, an overttest has occurred. If more than 90 percent of the SRS points lie between the upper and lower bounds, the desired qualification test has occurred. If none of the above occurs, and more than 10 percent of the points are below the lower bound, an undertest has occurred.
- f. If the test item or its mount fails, during a desired or an undertest, redesign the materiel and/or its mount to correct the deficiency.
- g. Retest the redesigned materiel and/or its mount following the above procedure.

MIL-STD-810H
METHOD 522.2**Table 522.2-II. SRS function for shock.**

Boundary	Natural Frequency	
	From 10 to 29.5 Hz	From 29.5 to 10 kHz
Upper Bound	$SRS = 0.17020f^2$	$SRS = 5.020f$
Average Shock (default)	$SRS = 0.06033f^2$	$SRS = 1.780f$
Lower Bound	$SRS = 0.03026f^2$	$SRS = 0.8927f$

2.4 Test Item Configuration.

- a. General. See Part One, paragraph 5.8.
- b. Specific to this Method. Configure the test item for ballistic shock as would be anticipated during service including particular attention to the details of the mounting of the materiel to the platform.

3. INFORMATION REQUIRED.**3.1 Pretest.**

The following information is required to conduct a ballistic test adequately.

- a. General. Information listed in Part One, paragraphs 5.7 and 5.9; and Annex A, Task 405 of this Standard.
- b. Specific to this Method.
 - (1) Type of ballistic shock test device.
 - (2) Means of initiation of the ballistic shock test device.
 - (3) Duration of the ballistic shock.
 - (4) General materiel configuration including measurement locations on or near the materiel.
 - (5) Test system (test item/platform configuration) detailed configuration including:
 - (a) Location of the ballistic shock test device.
 - (b) Location of the materiel.
 - (c) The structural path between the ballistic shock device and the materiel, and any general coupling configuration of the ballistic shock device to the platform and the platform to the materiel including the identification of structural joints..

3.2 During Test.

- a. General. Information listed in Part One, paragraphs 5.10; and in Part One, Annex A, Tasks 405 and 406 of this Standard.
- b. Specific to this Method.
 - (1) For test validation purposes, record deviations from planned or pre-test procedures or parameter levels, including any procedural anomalies that may occur. (See Part One, paragraph 5.10.)
 - (2) Damage to the test device or test fixture that may result in a variation of input test levels and preclude further testing until replaced or repaired.
 - (3) For Procedures II – VI, perform an operational verification of the component during/after each test.

3.3 Post-Test.

The following post test data shall be included in the test report.

- a. General. Information listed in Part One, paragraph 5.13, and in Annex A, Task 406 of this Standard.
- b. Specific to this Method.
 - (1) Duration of each exposure as recorded by an instrumented test fixture or test item, and the number of specific exposures.

MIL-STD-810H
METHOD 522.2

- (2) Any data measurement anomalies, e.g., high instrumentation noise levels, loss of sensors or sensor mounting as a result of testing, etc.

4. TEST PROCESS.

4.1 Test Facility.

Paragraph 6.1, reference a, describes four useful devices for ballistic shock testing. The most common is perhaps the drop table shock test machine used for shock testing of small items. For larger items that are sensitive to high frequency shock, higher frequency content and can only tolerate limited displacement, the Light Weight Shock Machine (LWSM) and Medium-Weight Shock Machine (MWSM) specified in MIL-S-901 can be useful tools for ballistic shock simulation. For large items, the Large Scale Ballistic Shock Simulator (LSBSS) uses an explosive charge to drive a plate to which the materiel is mounted.

- a. A BH&T device is the armor shell of a vehicle. It must contain the actual, fully functional, vehicle armor, but may not have an operational engine, suspension, gun, tracks, etc. The number of functional components and total weight of the BH&T device are adjusted to meet the requirements of each individual test effort.
- b. The LSBSS is a 22,700 kg (25 ton) structure that uses high explosives and hydraulic pressure to simulate the shock experienced by armored vehicle components and materiel (up to 500 kg (1100 lb)) caused by the impact of enemy projectiles.
- c. The MIL-S-901 Light Weight Shock Machine uses a 182 kg (400 lb) hammer to impact an anvil plate containing the test item. Hammer drops of 0.3 m (1 foot), 0.9 m (3 feet), and 1.5 m (5 feet) are used from two directions in three axes if the worst case axis is unknown. If the worst case axis is known and agreed, it is only necessary to test in the worst case axis.
- d. Mechanical shock simulators use a metal-to-metal impact (air or hydraulically driven projectile). The projectile impact is tuned to replicate the shock content (up to 10,000 Hz) of the 'default' shock level in Table 522.2-I.
- e. The MIL-S-901 Medium-Weight Shock Machine uses a 1360 kg (3000 lb) hammer to impact an anvil table containing the test item. Hammer height is a function of the weight on the anvil table (test item and all fixturing), and is specified in Table I of MIL-S-901.
- f. Drop tables typically have a mounting surface for the test item on an 'anvil' that is dropped from a known height. In some machines, the anvil is accelerated by an elastic rope, hydraulic, or pneumatic pressure to reach the desired impact velocity. The duration and shape (half-sine or saw tooth) of the impact acceleration pulse are determined by a 'programmer' (elastic pad or hydro-pneumatic device) that, in turn, determines the frequency content of the shock.

4.2 Controls / Tolerance.

- a. For shock-mounted components, it is often necessary to determine the transfer function of the shock mounting system. Typically, a 'dummy weight' of the appropriate mass and center of gravity is mounted in place of the test item and subjected to full level shocks. The input shock and test item responses are measured to verify performance of the shock mounts. Once shock mount performance has been verified, evaluation of an operational test item can begin.
- b. Prior to subjecting the test item to the full level shock, a variety of 'preparation' shocks are typically performed. For Procedure I (BH&T), a low level 'instrumentation check' round is normally fired prior to shooting actual threat ammunition. A typical 'instrumentation check' round would be 113 g to 453.6 g (4 to 16 oz.) of explosive detonated 2.54 to 45.7cm (1 to 18 inches) from the outer armor surface, and would usually produce no more than 10 percent of the shock expected from threat munition. For Procedure II (LSBSS), a low-level instrumentation check shot is usually fired prior to full level testing. For Procedure III (MIL-S-901 LWSM), the 1 foot hammer blow is normally used to check instrumentation, and any measurement problems are resolved prior to 0.9 and 1.5m (3 foot and 5 foot) hammer drops. For Procedure V (MIL-S-901 MWSM), use the 'Group 1' hammer height for the instrumentation check. A similar approach is used on Procedure VI, whereby a low-level drop is used to check instrumentation before conducting the full level shock.

MIL-STD-810H
METHOD 522.2

- c. For calibration procedures, review the guidance provided in Part One paragraphs 5.3.2. For tolerance procedures, refer to Section 517 Paragraph 4.2.2 and 4.2.1.1.

4.3 Test Interruption.

Test interruptions can result from two or more situations, one being from failure or malfunction of test equipment. The second type of test interruption results from failure or malfunction of the test item itself during operational checks.

4.3.1 Interruption Due To Test Equipment Malfunction.

- a. General. See Part One, paragraph 5.11, of this Standard.
- b. Specific to this Method.
 - (1) Undertest interruption. If an unscheduled interruption occurs that causes the test conditions to fall below allowable limits, reinitiate the test at the end of the last successfully completed cycle.
 - (2) Overtest interruptions. If the test item(s) is exposed to test conditions that exceed allowable limits, conduct an appropriate physical examination of the test item and perform an operational check (when practical) before testing is resumed. This is especially true where a safety condition could exist, such as with munitions. If a safety condition is discovered, the preferable course of action is to terminate the test and reinitiate testing with a new test item. If this is not done and test item failure occurs during the remainder of the test, the test results may be considered invalid. If no problem has been encountered during the operational checkout or the visual inspection, reestablish pre-interruption conditions and continue from the point where the test tolerances were exceeded. See paragraph 4.3.2 for test item operational failure guidance.

4.3.2 Interruption Due To Test Item Operation Failure.

Failure of the test item(s) to function as required during operational checks presents a situation with several possible options.

- a. The preferable option is to replace the test item with a “new” one and restart from Step 1.
- b. A second option is to replace / repair the failed or non-functioning component or assembly with one that functions as intended, and restart the entire test from Step 1.

<p>NOTE: When evaluating failure interruptions, consider prior testing on the same test item and consequences of such.</p>

4.4 Instrumentation.

Acceleration or velocity measurement techniques that have been validated in shock environments containing the high level, high frequency shock that characterizes ballistic shock must be used. See paragraph 6.1, reference g, for details. In general, ballistic shock measurements require the use of at least two different measurement technologies to cross check each other for validity. In addition, the frequency spectrum of ballistic shock content is generally so wide (10 Hz to more than 100,000 Hz) that no single transducer can make valid measurements over the entire spectrum. This broad time frequency environment provides a challenge to calibration of measurement sensors and any tolerances provided in the test plan.

4.4.1 Ballistic Shock Measurement Transducers.

As mentioned in reference g of paragraph 6.1, multiple transducers are usually required to make valid measurements over the entire spectrum of the ballistic shock environment (see references g and h). Figure 522.2-2 illustrates the limited “useful frequency range” of three different transducers. Note that the ATC Velocity Coil has a noticeable resonance at 70 Hz, but it agrees with the BOBKAT sensor from 300 Hz to 1,000 Hz, and provides useful data out to 1 MHz. The BOBKAT sensor indicates erroneous values below 30 Hz, and above 2 KHz, but agrees with the LOFFI from 30 Hz to 150 Hz and agrees with the ATC Velocity Coil from 400 Hz to 1 KHz. The LOFFI sensor provides useful data from 5 Hz to 150 Hz. The resonant frequency, damping ratio, and useful frequency range of each

MIL-STD-810H
METHOD 522.2

transducer should be taken into consideration and must be documented, so that transducer anomalies can be identified, if present in the measurement data.

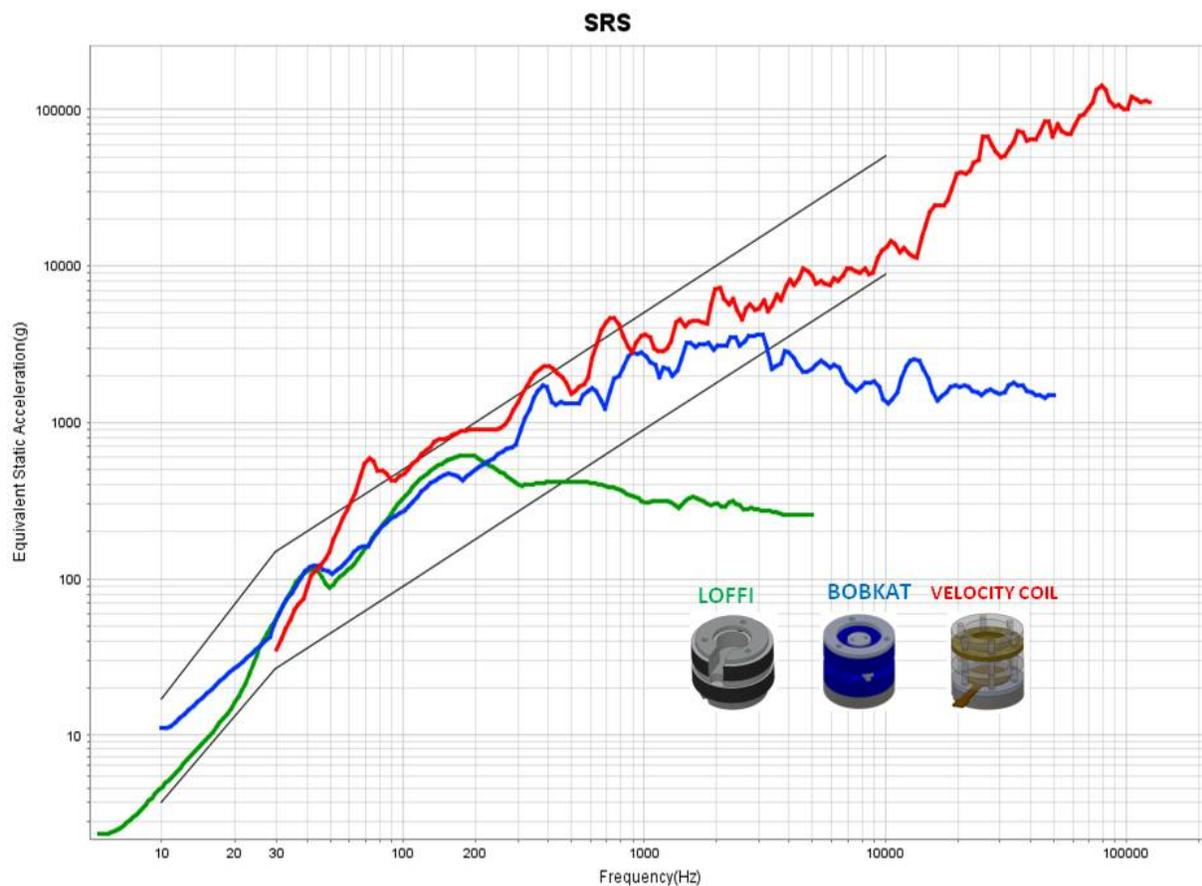


Figure 522.2-2. Shock Response Spectra from three different sensors needed to measure the entire spectrum (5 Hz to 100,000 Hz) of a ballistic shock event.

Transducers used in ballistic shock applications must be evaluated in the ballistic shock environment (roughly 1 MHz, roughly 1 million g, described in paragraph 1.2.3 above). Both field testing (using high explosives) and laboratory testing (such as the TCU shock machine and laser vibrometer described in reference g) are required to qualify transducers for use in a ballistic shock environment.

4.4.2 Data Acquisition Instrumentation.

4.4.2.1 Filtering and Frequency Response.

The data recording instrumentation shall have flat frequency response to at least 100 kHz for at least one channel at each measurement location. Attenuation of 3 dB at 100 kHz is acceptable. The digitizing rate must be at least 2.5 times the filtering frequency. Note that when measurements of peak amplitude are used to qualify the shock level, a sample rate of at least 10 times the filtering frequency (1 million samples per second) is required. Additional, lower frequency measurement channels, at the same location may be used for lower frequency response measurements.

It is imperative that a responsibly designed system to reject aliasing is employed. Analog anti-alias filters must be in place before the digitizer. The selected anti-alias filtering must have an attenuation of 50 dB or greater, and a pass band flatness within one dB across the frequency bandwidth of interest for the measurement (see Figure 522.2-3). Subsequent resampling e.g., for purposes of decimation, must be in accordance with standard practices and consistent with the analog anti-alias configuration (e.g. digital anti-alias filters must be in place before subsequent decimations).

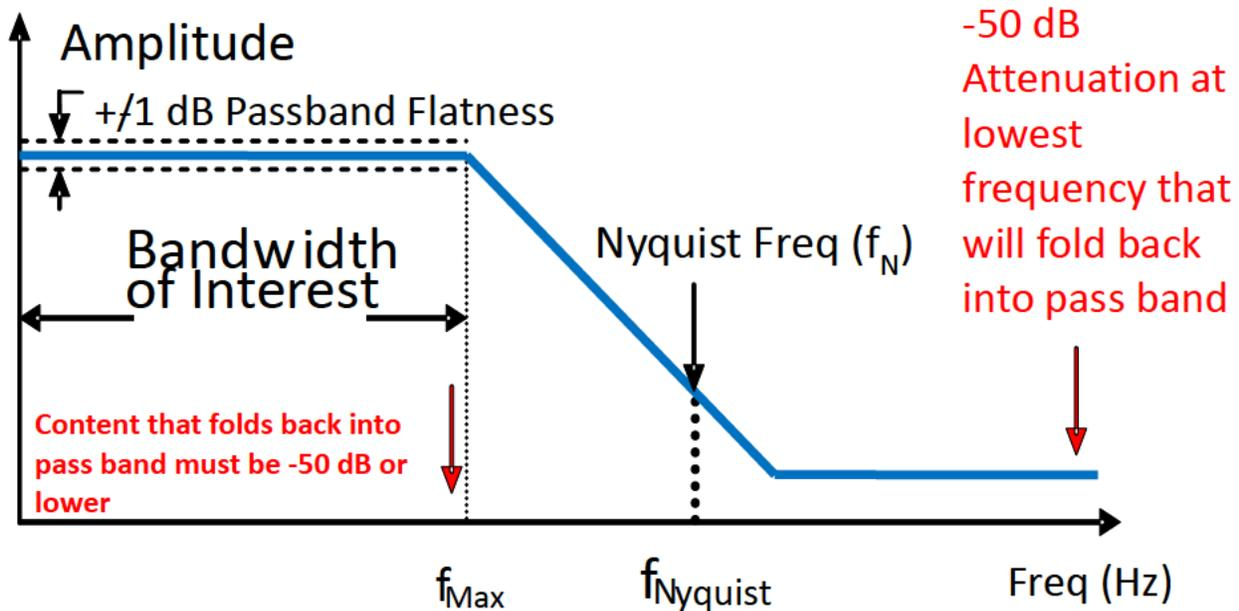
MIL-STD-810H
METHOD 522.2

Figure 522.2-3. Filter attenuation (conceptual, not filter specific).

The end to end alias rejection of the final discretized output must be shown to meet the requirements in Figure 522.2-3. The anti-alias characteristics must provide attenuation of 50 dB or greater for frequencies that will fold back into the passband. Spectral data including SRS plots may only be presented for frequencies within the passband (between 0 and f_{max}). However, this restriction is not to constrain digital data validation procedures that require assessment of digitally acquired data to the Nyquist frequency (either for the initial ADC or subsequent resampled sequences).

Verification of alias rejection should start by establishing the dynamic range within the pass band in terms of the signal to noise ratio (SNR). The $SNR = 20 \log_{10} (V_{FullScale} / V_{NoiseFloor})$ must be ≥ 60 dB. Once sufficient SNR is verified, establishing the alias rejection characteristics may be determined using an input sine wave with a magnitude of 0.5 * full scale range and at the lowest frequency range that can impinge i.e., be aliased into f_{max} , and then confirming (using the IEEE 1057 sine wave test procedure or through inspection of the time domain data) that the alias rejection is sufficient at this frequency. If the 1 million sample/second digitizing rate is used, for example, then $f_{Nyquist} = 500$ kHz. Theory says that if a signal above the Nyquist Ratio is present, it will “fold over” into a frequency below the Nyquist ratio. The equation is:

$F_a = \text{absolute value}[(F_s * n) - F]$, where

F_a = frequency of “alias”

F = frequency of input signal

F_s = sample rate

n = integer number of sample rate (F_s) closest to input signal frequency (F)

Hence the lowest frequency range that can fold back into the 100 kHz passband is from 900 kHz to 1,100 kHz = 0.9 to 1.1 MHz.

MIL-STD-810H
METHOD 522.2

It should be noted that Sigma Delta (SD) digitizers “oversample” internally at a rate several times faster than the output data rate. Analog anti-alias filtering for SD digitizers may be used at the Nyquist rate for the internal sample rate. For example, if a 1 million sample/second SD digitizer samples internally at 8 million samples/second, then the internal Nyquist frequency is 4 MHz, hence the analog anti-alias filter should remove content above 4 MHz that can fold back into the 100 kHz pass band (7.9 MHz to 8.1 MHz and similar bands that are higher in frequency). Figure 522.2-4 illustrates sampling frequencies, Nyquist frequencies, and frequency bands that can fold back into the bandwidth of interest for both conventional (“Successive Approximation”) digitizers and over sampling digitizers, such as the Sigma Delta digitizer.

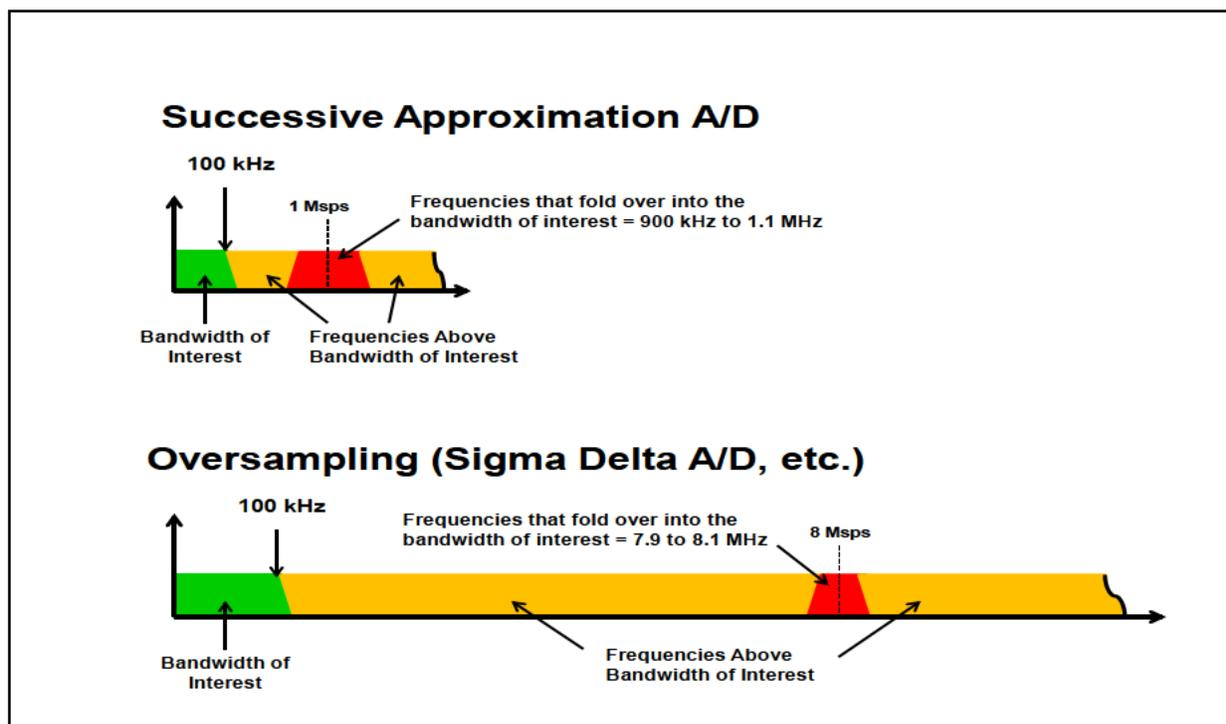


Figure 522.2-4 Illustration of sampling rates and out of band “fold over” frequencies for data acquisition systems.

4.4.2.2 Slew Rate.

To prevent distortion caused by spurious electrical noise, the data recording instrumentation shall be capable of recording a signal of one half full scale voltage in 1 microsecond without slew rate distortion. For example, if a system is capable of ± 10 volts full scale = 20 volt peak-to-peak, then a slew rate of 10 volt/ μ second is required.

4.4.2.3 Headroom.

Undamped piezoelectric and Micro Electro-Mechanical System (MEMS) accelerometers are known to produce very high output signals at resonance (up to 100 times higher than the actual mechanical input). For Procedures I (BH&T), II (LSBSS), III (LWSM), and IV (Mechanical Shock Simulator), there is serious risk of significant “Out of Band Energy” being generated by undamped accelerometers. This high frequency “Out of Band Energy” is capable of causing distortion in the data recording electronics. Precautions must be taken (and documented) to insure that “Out of Band Energy” signals, produced by undamped accelerometers, do not distort “In Band” measurements, due to inadvertent clipping at various amplification stages of the analog signal conditioning. The following alternatives are examples of acceptable precautions:

- Use of critically damped transducers (which do not produce significant “Out of Band Energy”).
- Use of long multi-conductor cables is not desirable, but is often unavoidable. Long cables can significantly attenuate the “Out of Band Energy” signals. If, for example, cable attenuation is shown to be -34 db (a factor of 50X), or more, at the resonant frequency of the undamped accelerometer, then the cable alone serves as acceptable protection from “Out of Band Energy”.

MIL-STD-810H
METHOD 522.2

- c. Use of an analog detector at each stage of amplification, to insure that no signal “clipping” occurs prior to filtering, serves as acceptable documentation as to where “Out of Band Energy” distortion did, or did not occur.
- d. Setting the full scale recording range to a factor of roughly 25X above the expected signal level (i.e. a “Headroom” of 25X) serves as acceptable protection from internal clipping due to “Out of Band Energy”. If the expected level was 2,000g, for example, the full scale range would be set to 50,000g. Hence a 50,000g “Out of Band Energy” signal could be accommodated without clipping. Unfortunately, the expected “In Band” signal level would only use 4% of the full scale capability of the recorder, compromising signal fidelity. Note that use of “Post Filter Gain” (gain applied after the anti-alias filter has removed the “Out of Band Energy”), reduces the amount of headroom required. In the previous example, the pre-filter gain would still be set to provide a range of 50,000g, but additional gain after the filter could amplify the signal before digitization, thereby increasing fidelity. The headroom of the post-filter gain would depend on knowledge of the expected in-band signal and fidelity requirements. For situations where the expected level is not well understood a post-filter gain overhead of 10X is recommended, or 20,000g in the example case.

4.5 Data Analysis.

Detailed analysis procedures for evaluation of the problems peculiar to ballistic shock measurement have not been established. Many (but not all) of the techniques described in paragraph 6.1, reference f are appropriate.

4.6 Test Execution.

4.6.1 Preparation for Test.

4.6.1.1 Preliminary Steps.

Prior to initiating any testing, review pretest information in the test plan to determine test details (e.g., procedures, test item configuration, ballistic shock levels, number of ballistic shocks):

- a. Choose the appropriate test procedure.
- b. If the ballistic shock is a calibrated test, determine the appropriate ballistic shock levels for the test prior to calibration.
- c. Ensure the ballistic shock signal conditioning and recording devices have adequate amplitude range and frequency bandwidth. It may be difficult to estimate a peak signal and arrange the instrumentation appropriately. In general there is no data recovery from a clipped signal. However, for over-ranged signal conditioning, it is usually possible to acquire meaningful results for a signal 20 dB above the noise floor of the measurement system. In some cases, redundant measurements may be appropriate - one measurement being over-ranged and one measurement ranged at the best estimate for the peak signal. The frequency bandwidth of most recording devices is usually readily available, but ensures that recording device input filtering does not limit the signal frequency bandwidth.

4.6.1.2 Pretest Checkout.

All items require a pretest checkout at standard ambient conditions to provide baseline data. Conduct the checkout as follows:

- Step 1 Conduct a complete visual examination of the test item with special attention to any micro electronic circuitry areas. Pay particular attention to its platform mounting configuration and potential stress wave transmission paths.
- Step 2 Document the results.
- Step 3 Where applicable, install the test item in its test fixture.
- Step 4 Conduct an operational checkout in accordance with the approved test plan, along with simple tests for ensuring the measurement system is responding properly.
- Step 5 Document the results for comparison with test data.
- Step 6 If the test item operates satisfactorily, proceed to the first test. If not, resolve the problem and restart at Step 1.

MIL-STD-810H
METHOD 522.2

Step 7 Remove the test item and proceed with the calibration.

4.6.2 Procedures.

The following procedures provide the basis for collecting the necessary information concerning the platform and test item undergoing ballistic shock. Since one of four or more ballistic shock devices may be employed, the instructions below must be consistent with the ballistic shock device selected.

4.6.2.1 Procedure I – BH&T.

- Step 1 Select the test conditions and mount the test item in a Ballistic Hull and Turret (BH&T), that may require ‘upweighting’ to achieve the proper dynamic response. (In general, there will be no calibration when actual hardware is used in this procedure). Select measurement techniques that have been validated in ballistic shock environments. See paragraph 6.1, reference g, for examples.
- Step 2 Perform an operational check on the test item.
- Step 3 Fire threat munitions at the BH&T and verify that the test item operates as required. Typically, make shock measurements at the mounting location (‘input shock’) and on the test item (‘test item response’).
- Step 4 Record necessary data for comparison with pretest data.
- Step 5 Photograph the test item as necessary to document damage.
- Step 6 Perform an operational check on the test item. Record performance data. See paragraph 5 for analysis of results.

4.6.2.2 Procedure II – LSBSS.

- Step 1 Mount the test item to the LSBSS using the same mounting hardware as would be used in the actual armored vehicle. Select the orientation of the test item with the intent of producing the largest shock in the ‘worst case’ axis.

NOTE: A ‘dummy’ test item is typically mounted until measurements confirm that the proper explosive ‘recipe’ (i.e., combination of explosive weight, stand-off distance, and hydraulic displacement) has been determined to obtain the shock levels specified in Table 522.2-I and on Figure 522.2-1. Then mount an operational test item to the LSBSS.

- Step 2 Fire the LSBSS and verify the test item is operating as required before, during, and after the shot. If the test item fails to operate as intended, follow the guidance in paragraph 4.3.2 for test item failure.
- Step 3 Record initial data for comparison with post test data.
- Step 4 Fire three test shots at the shock level specified in Table 522.2-I.
- Step 5 Inspect the test item; photograph any noted damage, and record data for comparison with pretest data.

4.6.2.3 Procedure III – LWSM.

- Step 1 Modify the mounting for the anvil plate to restrict total travel (including dynamic plate deformation) to 15 mm (0.59 inch). Mount the test item to the LWSM using the same mounting hardware as would be used in an actual armored vehicle. Choose the orientation of the test item with the intent of producing the largest shock in the ‘worst case’ axis.
- Step 2 Perform a pretest checkout and record data for comparison with post test data.

NOTE: Typically, make shock measurements at the ‘input’ location to ensure the low frequency shock levels specified in Table 522.2-I and in Figure 522.2-1 have been attained on the 1.5 m (5 foot) drop.

MIL-STD-810H
METHOD 522.2

- Step 3 Perform a 0.3 m (1 foot) hammer drop followed by an operational check; record data. If the test item fails to operate as intended, follow the guidance in paragraph 4.3.2 for test item failure. Otherwise, proceed to Step 4.
- Step 4 Perform a 0.9 m (3 foot) hammer drop followed by an operational check; record data. If the test item fails to operate as intended, follow the guidance in paragraph 4.3.2 for test item failure. Otherwise, go to Step 5.
- Step 5 Perform a 1.5 m (5 foot) hammer drop followed by an operational check; record data. If the test item fails to operate as intended, follow the guidance in paragraph 4.3.2 for test item failure.
- Step 6 Repeat Step 5 two more times.
- Step 7 If the worst case axis is unknown (see paragraph 4.1c), repeat Steps 2-6 for each direction of each axis for a total of 18 five-foot hammer drops. See paragraph 5 for analysis of results.

4.6.2.4 Procedure IV – Mechanical Shock Simulator.

- Step 1 Mount the test item to the Mechanical Shock Simulator using the same mounting hardware as would be used in the actual armored vehicle. Select the orientation of the test item with the intent of producing the largest shock in the ‘worst case’ axis.
- Step 2 Launch the mechanical shock simulator projectile and verify the test item is functioning as required before, during, and after the shot.
- Step 3 Record initial data for comparison with post test data.
- Step 4 Conduct three test shots at the shock level specified in Table 522.2-I.
- Step 5 If the worst case axis is unknown (see paragraph 4.1c), repeat Steps 2-6 for each direction of each axis, for a total of 18 projectile impacts.
- Step 6 Inspect the test item; photograph any noted damage, and record data for comparison with pretest data. Perform an operational check on the test item. Record performance data. See paragraph 5 for analysis of results.

4.6.2.5 Procedure V – MWSM.

- Step 1 Modify the supports for the anvil table (by shimming the 4 table lifts) to restrict table total travel (including dynamic plate deformation) to 15 mm (0.59 inch).
- Step 2 Mount the test item to the MWSM using the same mounting hardware as would be used in an actual combat vehicle. Choose the orientation of the test item with the intent of producing the largest shock in the ‘worst case’ axis (see Step 7 below).
- Step 3 Perform a pretest checkout and record data for comparison with post test data.

<p>NOTE: Typically, make shock measurements at the ‘input’ location to ensure that the low-frequency shock levels specified in Table 522.2-I and on Figure 522.2-1 have been attained on the ‘Group III’ drop (from MIL-S-901).</p>
--

- Step 4 Perform a ‘Group I height’ hammer drop followed by an operational check; record data. If the test item fails to operate as intended, follow the guidance in paragraph 4.3.2 for test item failure.
- Step 5 Perform a ‘Group III height’ hammer drop followed by an operational check; record data.
- Step 6 Repeat Step 5 two more times.
- Step 7 If the worst case axis is unknown (see paragraph 4.1c), repeat Steps 2-6 for each direction of each axis for a total of 18 hammer drops at the Group III height.

MIL-STD-810H
METHOD 522.2**4.6.2.6 Procedure VI – Drop Table.**

- Step 1 Calculate the expected response of a shock mounted test item (or measurements from field tests may be used) and calculate a shock response spectra (SRS). Choose a half-sine acceleration pulse whose SRS ‘envelopes’ the expected response of the shock mounted item. Note that this approach typically results in an overttest at the lowest frequencies.
- Step 2 Hard mount the test item to the drop table.
- Step 3 Conduct an operational check and record data for comparison with post test data. If the test item operates satisfactorily, proceed to Step 4. If not, resolve the problems and repeat this step.
- Step 4 Test using the appropriate half-sine acceleration pulse three times in each direction of all three axes (18 drops).
- Step 5 Conduct a performance check and record data for comparison with pretest data. See paragraph 5 for analysis of results.

5. ANALYSIS OF RESULTS.

In addition to the guidance provided in Part One, paragraphs 5.14 and 5.17, and in Part One, Annex A, Tasks 405 and 406, the following information is provided to assist in the evaluation of the test results. Analyze any failure of a test item to meet the requirements of the system specifications, and consider related information. Carefully evaluate any failure in the structural configuration of the test item, e.g., mounts, that may not directly impact failure of the functioning of the materiel but that would lead to failure in its service environment conditions.

6. REFERENCE/RELATED DOCUMENTS.**6.1 Referenced Documents.**

- a. Walton, W. Scott, “Ballistic Shock Simulation Techniques for Testing Armored Vehicle Components”, Proceedings of the 64th, Shock and Vibration Symposium, Volume I, October 1993, pp. 237-246. Shock & Vibration Exchange (SAVE), 1104 Arvon Road, Arvon, VA 23004.
- b. Walton, W. Scott and Joseph Bucci, “The Rationale for Shock Specification and Shock Testing of Armored Ground Combat Vehicles”, Proceedings of the 65th Shock and Vibration Symposium, Volume I, October 1994, pp. 285-293. Shock & Vibration Exchange (SAVE), 1104 Arvon Road, Arvon, VA 23004.
- c. MIL-S-901, “Shock Tests, H.I. (High Impact), Shipboard Machinery, Equipment, and Systems, Requirements for”.
- d. MIL-STD-331, “Fuze and Fuze Components, Environmental and Performance Tests for”.
- e. Kelly, Ronald D. and George Richman, “Principles and Techniques of Shock Data Analysis”, Shock & Vibration Exchange (SAVE), 1104 Arvon Road, Arvon, VA 23004.
- f. Handbook for Dynamic Data Acquisition and Analysis, IEST-RD-DTE012.2, Institute of Environmental Sciences and Technology, Arlington Place One, 2340 S. Arlington Heights Road, Suite 100, Arlington Heights, IL 60005-4516; Institute of Environmental Sciences and Technology Website.
- g. Walton, W. Scott, “Pyroshock Evaluation of Ballistic Shock Measurement Techniques”, Proceedings of the 62nd Shock and Vibration Symposium, Volume 2, pp. 422-431, October 1991. Shock & Vibration Exchange (SAVE), 1104 Arvon Road, Arvon, VA 23004.
- h. Hepner, Brandon, Monahan, Christopher, and Walton, W. Scott, “Improved Mid-Frequency Measurement of Ballistic Shock”, 81st Shock and Vibration Symposium, October 2010. Shock & Vibration Exchange (SAVE), 1104 Arvon Road, Arvon, VA 23004.

6.2 Related Documents.

- a. Allied Environmental Conditions and Test Publication (AECTP) 400, Mechanical Environmental Tests (under STANAG 4370), Method 422.

MIL-STD-810H
METHOD 522.2

- b. Egbert, Herbert W. "The History and Rationale of MIL-STD-810 (Edition 2)", January 2010; Institute of Environmental Sciences and Technology, Arlington Place One, 2340 S. Arlington Heights Road, Suite 100, Arlington Heights, IL 60005-4516.

(Copies of Department of Defense Specifications, Standards, and Handbooks, and International Standardization Agreements are available online at <https://assist.dla.mil>.

Requests for other defense-related technical publications may be directed to the Defense Technical Information Center (DTIC), ATTN: DTIC-BR, Suite 0944, 8725 John J. Kingman Road, Fort Belvoir VA 22060-6218, 1-800-225-3842 (Assistance--selection 3, option 2), <http://www.dtic.mil/dtic/>; and the National Technical Information Service (NTIS), Springfield VA 22161, 1-800-553-NTIS (6847), <http://www.ntis.gov/>.

MIL-STD-810H
METHOD 522.2

(This page is intentionally blank.)

MIL-STD-810H
METHOD 523.4**METHOD 523.4****VIBRO-ACOUSTIC/TEMPERATURE****CONTENTS**

<u>Paragraph</u>	<u>Page</u>
1. SCOPE	1
1.1 PURPOSE	1
1.2 APPLICATION.....	1
1.3 LIMITATIONS	1
2. TAILORING GUIDANCE	2
2.1 SELECTING THE VIBRO-ACOUSTIC/TEMPERATURE METHOD.....	2
2.1.1 EFFECTS OF THE VIBRO-ACOUSTIC/TEMPERATURE ENVIRONMENT	2
2.1.1.1 RELATIVE IMPORTANCE OF ENVIRONMENTAL STRESSES.....	2
2.1.1.2 OTHER ENVIRONMENTAL STRESSES.....	2
2.1.1.3 OPERATION	2
2.1.1.4 TEMPERATURE.....	3
2.1.1.5 VIBRATION.....	4
2.1.1.6 MOISTURE.....	5
2.1.1.7 SHOCK.....	5
2.1.1.8 ALTITUDE.....	5
2.1.1.9 OTHER ENVIRONMENTS	5
2.1.2 SEQUENCE AMONG OTHER METHODS.....	5
2.2 SELECTING A PROCEDURE	5
2.3 DETERMINATION OF TEST LEVELS AND CONDITIONS	5
2.4 TEST ITEM CONFIGURATION.....	6
3. INFORMATION REQUIRED.....	6
3.1 PRETEST	6
3.2 DURING TEST	7
3.3 POST-TEST	7
4. TEST PROCESS	8
4.1 TEST FACILITY	8
4.1.1 GENERAL	8
4.1.2 ACOUSTIC CHAMBER	8
4.1.2.1 ACOUSTIC CHAMBER AND ACOUSTIC SOURCE.....	8
4.1.2.2 VIBRATION EQUIPMENT	8
4.1.3 TEMPERATURE EQUIPMENT	8
4.1.4 ELECTRICAL STRESS.....	9
4.2 INSTRUMENTATION	9
4.3 CONTROLS.....	10
4.3.1 TEST INTERRUPTION.....	10
4.3.2 INTERRUPTION DUE TO TEST FACILITY MALFUNCTION	10
4.3.3 INTERRUPTION DUE TO TEST ITEM OPERATION FAILURE	11
4.3.4 FUNCTIONAL MONITORING.....	11
4.3.5 VIBRATION MONITORING AND CONTROL	11
4.3.6 TEMPERATURE MONITORING AND CONTROL.....	12

MIL-STD-810H
METHOD 523.4**CONTENTS - Continued**

<u>Paragraph</u>	<u>Page</u>
4.3.7 HUMIDITY MONITORING.....	12
4.3.8 POWER MONITORING	12
4.4 DATA ANALYSIS.....	12
4.5 TEST EXECUTION	12
4.5.1 PREPARATION FOR TEST.....	12
4.5.2 PRETEST CHECKOUT	13
4.5.3 TEST SETUP AND CYCLE CHECK PROCEDURE	13
4.5.4 PROCEDURE	14
5. ANALYSIS OF RESULTS	15
6. REFERENCE/RELATED DOCUMENTS	16
6.1 REFERENCED DOCUMENTS.....	16
6.2 RELATED DOCUMENTS.....	16

TABLE

TABLE 523.4-I. TYPICAL APPLICATIONS.....	15
--	----

**METHOD 523.4 ANNEX A
VIBRO-ACOUSTIC/TEMPERATURE TEST PROFILE DEVELOPMENT**

1. SCOPE	A-1
1.1 PURPOSE	A-1
1.2 APPLICATION.....	A-1
2. DEVELOPMENT.....	A-1
2.1 BACKGROUND.....	A-1
2.2 GENERAL	A-1
2.3 MISSION CHARACTERIZATION	A-1
2.4 MISSION ANALYSIS	A-2
2.4.1 MISSION TEMPERATURES.....	A-3
2.4.2 MISSION VIBRATION.....	A-4
2.4.3 TEST TEMPERATURE PROFILE	A-5
2.4.4 TEST VIBRATION PROFILE	A-7
2.4.5 OPERATIONAL DUTY CYCLE	A-7
3. TEST CONFIGURATION	A-7

ANNEX A FIGURES

FIGURE 523.4A-1. TYPICAL AIRCRAFT OPERATIONAL MISSION PROFILE	A-2
FIGURE 523.4A-2. TEMPERATURE PROFILE FOR A SINGLE MISSION TYPE	A-3
FIGURE 523.4A-3. CLIMATIC SET OF TEMPERATURE PROFILES FOR COMPOSITE MISSION.....	A-4
FIGURE 523.4A-4. SELECTION OF EQUI-PROBABLE TEMPERATURES FROM THE CUMULATIVE DISTRIBUTION OF CLIMATIC TEMPERATURES	A-6
FIGURE 523.4A-5. CLIMATIC SET PLAN SHOWING OFFSET SEQUENCES	A-6
FIGURE 523.4A-6. DYNAMIC PRESSURE, Q, PROFILE FOR COMPOSITE MISSION	A-7
FIGURE 523.4A-7. TYPICAL ARRANGEMENT OF TEST APPARATUS.....	A-8

MIL-STD-810H
METHOD 523.4

CONTENTS - Continued

<u>Paragraph</u>	<u>Page</u>
ANNEX A TABLES	
TABLE 523.4A-I. RELATIVE FREQUENCY OF OCCURRENCE OF MISSION TYPES	A-1
TABLE 523.4A-II. MISSION PHASE ANALYSIS (FIGHTER B, STRIKE MISSION)	A-2
TABLE 523.4A-III. TEMPERATURE OFFSETS	A-6

MIL-STD-810H
METHOD 523.4

(This page is intentionally blank.)

MIL-STD-810H
METHOD 523.4**METHOD 523.4****VIBRO-ACOUSTIC/TEMPERATURE**

NOTE: Tailoring is essential. Select methods, procedures, and parameter levels based on the tailoring process described in Part One, paragraph 4.2.2, and Annex C. Apply the general guidelines for laboratory test methods described in Part One, paragraph 5 of this standard.

1. SCOPE.**1.1 Purpose.**

The vibro-acoustic/temperature procedure is performed to determine the synergistic effects of vibration, acoustic noise, and temperature on externally carried aircraft stores during captive carry flight. Such determination may be useful for, but not restricted to the following purposes:

- a. To reveal and correct design weaknesses (Test, Analyze and Fix (TAAF) test).
- b. To determine whether a design meets a specified reliability requirement (Reliability Demonstration test).
- c. To reveal workmanship or component defects before a production unit leaves the place of assembly (Screening test).
- d. To estimate the Mean Time Between Failure (MTBF) of a lot of units based upon the test item's time to failure of a small sample of the units (Lot Acceptance test).
- e. To determine the relative reliability among units based upon the test item's time to failure of a small sample of the units (Source Comparison test).

1.2 Application.

For captively-carried stores, this method is intended primarily to test electronics and other electro-mechanical assemblies within the store for functionality in a vibro-acoustic/temperature environment. As an incidental part of the testing, thermal variation may induce changes in moisture exposure of the store and the effects of such exposure must be noted when interpreting the test result data. Typical applications include:

- a. development of a more reliable store design prior to production.
- b. assessment of the potential for satisfaction of the reliability requirement for a store.
- c. manufacturer's internal testing to assure delivery of reliable units during production.
- d. determination of the acceptance of a lot prior to delivery.
- e. determination of the relative differences in quality from two sources for establishing production buy proportions.

1.3 Limitations.

This method is not intended to provide for:

- a. An environmental design qualification test of a store or any of its individual components for functionality. (For such testing see Method 500 Altitude; Method 501 High Temperature; Method 502 Low Temperature; Method 503 Temperature Shock; Method 507 Humidity; Method 513 Acceleration; Method 514 Vibration; Method 515 Acoustic Noise; Method 516 Shock; Method 517 Pyroshock; and Method 520 Temperature, Humidity, Vibration, Altitude).
- b. An environmental design qualification test of a store airframe or other structural components for structural integrity.
- c. Any test to satisfy the requirements of the Life Cycle Profile except that for the combined vibration, acoustic, and temperature environments related to reliability testing.

MIL-STD-810H
METHOD 523.4**2. TAILORING GUIDANCE.****2.1 Selecting the Vibro-Acoustic/Temperature Method.**

After examining requirements documents and applying the tailoring process in Part One of this standard to determine where the vibro-acoustic/temperature environments are anticipated in the life cycle of the materiel, use the following to confirm the need for this method and to place it in sequence with other methods.

2.1.1 Effects of the Vibro-Acoustic/Temperature Environment.

Possible effects of a combination of vibration, acoustic noise, and temperature include all effects that these factors can cause separately (see Methods 514, 515, and 520). In addition, increased stress as a result of moisture from thermal change may produce possible effects seen in Methods 501, 502, 503, and 507. The combined vibration, acoustic noise, and temperature environments may interact to produce effects that would not occur in any single environment or a lesser combination of environments. Items in the discussion to follow point to significant effects of mechanisms applicable to this method.

2.1.1.1 Relative Importance of Environmental Stresses.

Not all environmental stresses contribute equally to materiel deterioration or failure. Analysis of service-use failures caused by aircraft environmental stress on the store (paragraph 6.1, reference a) has identified the following four most important causes of failure:

- a. loading of the store through captive carriage,
- b. temperature,
- c. vibration, and
- d. moisture.

2.1.1.2 Other Environmental Stresses.

Consider the inclusion of other environmental stresses that may be important for particular materiel. In general, it is not appropriate to include comparatively rare occurrences of extreme stress levels that are better quantified in single environment methods described elsewhere in this standard. A general guideline for this determination for an individual stress is that, if a stress has a "fraction of time of occurrence" (FTO) less than 0.1 (10 percent) of the total time specified for the store's MTBF, the condition may be considered too rare to be included in a test described by this method. In evaluating FTO, consider all in-service use environments and use the more severe of the two. Note that the term FTO is used here in place of the more traditional probability of occurrence. FTO is defined for a level of stress as the ratio of the time the store is under the stress condition divided by the total time of observation, e.g., the store's mean time between failures. Probability of occurrence relates to the chances a stress event will occur, and may not relate directly to a single specific time interval. FTO can be shown to provide an estimate of the probability distribution of the level of stress and is a more precise term. A simple example of this difference is as follows: If the stress condition is the absolute value of the acceleration at a point in the store that is above 5g's, the FTO is easily established from an auto-spectral density (ASD) estimate over a specified time interval. This implies a stationary Gaussian time history with zero mean and standard deviation as the square root of the area under the ASD estimate. The probability of occurrence relates to the number of times the 5g level is exceeded, but the total time above 5g may vary from one occurrence to the next, depending on the difference in ASD estimates and on the associated duration of each of the stationary Gaussian ASD estimates.

2.1.1.3 Operation.

Operating any materiel item produces stress that can cause failure. In the case of external aircraft stores, operation generally means providing full electrical power that produces thermal, electromagnetic, and electrochemical stress. Duty cycles (on/off), low and high voltage, power ripple, and voltage spikes may also be significant stresses. Even when the stress of operation is negligible, it is necessary to operate the materiel under test to detect the presence of failure. Many failures induced by temperature and some vibration-induced failures are reversible, at least initially. As the test continues, reversible failures tend to become irreversible. Thus, it is important to conduct functional tests while the environmental stresses are present.

MIL-STD-810H
METHOD 523.4**2.1.1.4 Temperature.**

The most severe temperature shock to internal components may come from powering the materiel when it is cold. In order to induce all the stresses related to temperature in their proper proportion, use a thermal model of the store to predict the temperatures and rates of change at several internal points under service mission profiles.

- a. Ambient temperature. The greatest variations in ambient temperature occur near the surface of the Earth. The low temperature extreme exposure by a store is, in many cases, due to low ambient temperatures immediately preceding flight. This is because there is ample time for temperature soak and there is no internal power dissipation or aerodynamic heating. Hence, it is important to consider on-the-ground temperatures in determining the initial captive flight temperature. The test temperature cycle may need to include a simulated on-the-ground period in order to normalize the temperature for the next simulated mission phase; otherwise an uninterrupted sequence of simulated missions may tend to drive the average internal temperature up or down relative to real missions. NATO STANAG 4370, AECTP 230, and MIL-HDBK-310 (paragraphs 6.1, references b and c) provide ground ambient air temperatures and their probability of occurrence for various regions. The temperatures that are cited in the two documents are those measured for meteorological purposes, and do not include the heating effects of direct sunlight or cooling due to radiation into the night sky. Hence, in determining preflight temperatures, consider the effects of radiation heat transfer, and remember to convert from probability of occurrence to FTO in application.
- b. Aerodynamic heating. During captive flight, the high convective heat transfer rate will cause the surface temperature of an external store to be near that of the boundary layer. The recovery air temperature in the boundary layer depends primarily on the ambient temperature and the speed of flight. The functional dependence is:

$$T_r = T_o \theta \left(1 + r(\gamma - 1) \frac{M^2}{2} \right)$$

where:

T_r = boundary layer recovery air temperature, °K (°R)

T_o = sea level air temperature (standard day), 288.16 °K (518.69 °R)

θ = ratio temperature at altitude to sea level temperature (standard day)

(varies with altitude in two altitude ranges, see Method 514.8, Annex D, Table 514.8D-V)

r = 0.87, boundary layer temperature recovery factor

γ = 1.4, atmospheric ratio of specific heats

M = flight Mach number

Since flight at high altitude, where the ambient temperatures are lowest, is usually at higher Mach numbers (>0.80), the low temperatures are generally mitigated by aerodynamic heating. Because of the dominance of boundary layer heat transfer, radiation heat transfer can be neglected in captive flight.

- c. Power dissipation. Although the high heat transfer rate will tend to keep the surface of a store at the boundary layer recovery temperature, internal temperatures may be considerably higher due to power dissipation of electronic equipment. For this reason the duty cycle of the materiel being tested must be tailored to reflect realistic operation and it must be coordinated with the external temperature to achieve a good reproduction of the expected temperatures.
- d. Temperature gradients. The strongest temperature gradients will usually be those associated with powering the materiel when it is cold. Temperature gradients will also occur due to changes in flight speed and altitude that change the surface temperature more rapidly than internal temperatures.

MIL-STD-810H
METHOD 523.4**2.1.1.5 Vibration.**

Vibration may cause mechanical fatigue failure of parts, abrasion due to relative motion, dislodging of loose particles that can cause electrical shorts, and degradation of electronic functions through microphonics and triboelectric noise. Experiments (paragraph 6.1, reference d) and theoretical analysis (paragraph 6.1, reference e) have shown that the relative likelihood of various failure modes change with vibration level. In order to reproduce the service failure modes in proper proportion, it is necessary to test at several levels, keeping the fraction of time (FOT) in each level the same as predicted for the service use. The vibration spectrum may be considered to consist of two parts: the low frequency part that includes those vibrations that can be transmitted from the aircraft, through the store attachments, into the store (this is not the only source of low frequency vibration, but it is the major one), and the high frequency part that is driven almost entirely by pressure fluctuations in the boundary layer acting directly on the surface of the store. Generally, the mechanical impedance of the store attachment is such that the division between low and high frequency is between 100 Hz and 200 Hz.

- a. Low frequency vibration. The low frequency vibration primarily stresses the structure, including brackets, large circuit boards, and electromechanical devices (e.g., gyros, relays). In most cases it is driven by transmission from the aircraft; hence, input excitation through the normal attachment points with a mechanical shaker best reproduces the low frequency vibration. Use Method 514 as a guide. Note that fluctuating aerodynamic forces may also act in the low frequency range. For control surfaces, wings, or other structure with a large area-to-mass ratio, the direct aerodynamic forces may be dominant. For this reason, the low frequency vibration of the test item cannot be regarded as a test of the structural fatigue life for wings, fins, or their attachments. In general, separate tests on components are needed to determine structural fatigue life of these components.
- b. High frequency vibration. Above the frequency at which the store attachments can transmit vibration, the vibration is driven by the boundary layer turbulence (paragraph 6.1, reference f). This vibration does not contribute to failure of the basic structure, but is often a cause of failure in electronics. The characteristics of the pressure fluctuations in the boundary layer are well known (paragraph 6.1, reference g). The significant aspects for external stores are:
 - (1) The pressure spectrum is almost flat, out to the highest frequencies to which stores' component parts respond (the -3dB point is about 4000 Hz). Hence, the vibration spectrum of an external store is determined almost entirely by its natural frequency responses.
 - (2) The RMS level of the pressure fluctuations, and hence the vibration, is approximately proportional to the dynamic pressure, q , that is a function of flight speed and altitude:

$$q = \frac{1}{2} \rho_0 \sigma V_a^2 M^2$$

where:

q = dynamic pressure, kN/m² (lb/ft²)

ρ_0 = sea level atmospheric density, 1.2251x10⁻³ kg/m³ (2.3770x10⁻³ lb sec²/ft⁴)

σ = ratio of local atmospheric density to sea level atmospheric density (standard atmosphere)
(varies with altitude in two altitude ranges, (see Method 514.8, Table 514.8D-V))

V_a = speed of sound at sea level (standard atmosphere), 340.28 m/sec (1116.4 ft/sec)

M = flight Mach number

Modern aircraft flight speed is typically measured in terms of calibrated air speed or Mach number. See Method 514.7, Annex A, paragraph 2.6, and Annex D, Table 514.8D-V (Dynamic pressure calculation) for a more detailed explanation and calculation methods. Determine the proportionality between vibration level at particular points in the store and flight dynamic pressure by flight measurements. If flight data cannot be obtained, use similarity to other stores (paragraph 6.1, reference h), or Method 514.8, Annex D, Table 514.8D-V, and Figures 514.8D-5, -6, and -7 as guidance.

MIL-STD-810H
METHOD 523.4**2.1.1.6 Moisture.**

Moisture, in conjunction with soluble contaminants, can result in corrosion. In conjunction with electrical power it may result in shorts. Freezing of water in confined spaces may produce mechanical stress. The test cycle should provide for diffusion of water vapor and condensation. The amount of water is generally not important for inducing failures, so humidity need not be controlled in this test. This test is not a substitute for corrosion tests, such as the humidity test (Method 507) or the salt fog test (Method 509).

2.1.1.7 Shock.

Shock can cause failure through mechanical stress similar to that induced by vibration. Shocks that are more nearly transient vibrations (many zero crossings), such as aircraft catapult and arrested landing shock may be included in this test. Short duration shocks such as pyrotechnic shocks associated with store or sub-munition launch, flight surface deployment, etc., are generally too difficult to reproduce at the store level. Ensure that these events that are potentially destructive to electronics are accounted for in other analyses and tests (See Method 517, Pyroshock, and Method 516, Shock).

2.1.1.8 Altitude.

Barometric pressure is generally not a stress for external stores. However, variation in pressure may enhance the penetration by moisture. Reduced pressure may increase the temperature due to reduced power dissipation and there may be increased electrical arcing. Test separately for resistance to arcing. Moisture penetration will generally take place without pressure variation and, in most cases, the amount of water entrained is not important so long as it is enough to provide internal condensation. Reduced heat transfer may be realized by restricting air circulation rather than reducing ambient pressure. In general, altitude simulation is not needed in this test.

2.1.1.9 Other Environments.

Although this method is intended primarily to reproduce the environmental stresses associated with the captive flight of external stores, it can be extended to include other phases of a store's life cycle provided the relative duration of those phases can be related to captive flight. For example, periods of shock and vibration representing transportation and handling have been included in some tests. Do not use environments in this test that are not expected to produce failures randomly distributed in time. For example, corrosive atmospheres and fungal growth are environments in which failures, if any, will occur only after a considerable time lapse. Store ejection shock, sand and dust, and water immersion are examples of environments for which failure either occurs or does not; these failures are associated with the event rather than being distributed in time. These environments are not appropriate for this method. Care is required in deciding which environments to include. For example, consider the case of a store that ejects sub-munitions, flares, chaff, or other items. In this case there will be a series of shock events that may be an important part of the continuing operational store environment. This may also result in open cavities in the store's external surface resulting in high intensity cavity noise for long periods.

2.1.2 Sequence Among Other Methods.

- a. General. Use the anticipated life cycle sequence of events as a general sequence guide (see Part One, paragraph 5.5).
- b. Specific to this method. This method applies to environmental stress occurring in the final phases of the store's environmental life cycle. When a single test item is subjected to this test and other environmental tests of this standard, perform this test after the tests representing earlier phases of the life cycle, but before tests representing store ejection/launch, free flight, target impact, etc.

2.2 Selecting a Procedure.

This method includes one test procedure that may be tailored to many test requirements.

2.3 Determination of Test Levels and Conditions.

Having selected this method, complete the tailoring process by identifying appropriate parameter levels and applicable test conditions and techniques for this procedure. Base these selections on the requirements documents, the Life Cycle Environmental Profile (LCEP), and information provided with this procedure. Consider the following when selecting test levels. Unlike other methods in this standard, this method does not contain any default values for test conditions. The combinations of vibration, acoustics, temperature, and duty-cycle environment are too complex

MIL-STD-810H
METHOD 523.4

and the variety of materiel applications too great for such detailed instruction to be given here. Instead, this method provides guidance for writing a test procedure that will be more or less unique to the materiel and test item. Annex A provides a detailed example of the development of test levels and conditions. Before attempting to apply the method, study the example in the Annex. In determination of test levels and conditions, identify the following:

- a. Mission characterization to develop a composite aircraft/store mission profile.
- b. Mission analysis to develop:
 - (1) Mission temperature analysis for development of a mission temperature profile over time;
 - (2) Mission vibration spectra identification for development of a mission vibration profile over time¹;
 - (3) Mission operational duty cycle for functional performance of the store over time.

2.4 Test Item Configuration.

- a. General. See Part One, paragraph 5.8.
- b. Specific to this method. The configuration of the test item strongly affects test results. Use the anticipated configuration of the materiel in the life cycle profile. As a minimum consider the store captive carry service use environment.

3. INFORMATION REQUIRED.

3.1 Pretest.

The following information is required to conduct a vibro-acoustic/temperature test:

- a. General. Information listed in Part One, paragraphs 5.7, 5.8, and 5.9; and Part One, Annex A, Task 405 of this standard.
- b. Specific to this method.
 - (1) A written, step-by-step procedure for conduct of the test that implements the test plan. Include the recording and documenting of test events and measurements. It may include other existing procedures by reference; but explicitly include any procedures related to safety.
 - (2) Quantity of items to be tested.
 - (3) Composite mission profile. Include in the detailed environmental test plan (DETP) (either directly or by reference), information used in designing the composite mission profile. Include the following:
 - (a) The particular environmental and operational variables to be controlled in the test (a minimum set includes vibration level, vibration spectrum, skin temperature, and duty cycle).
 - (b) The mission profiles, including aircraft types, store load, and percentage of occurrence of different missions.
 - (c) The climatic region of operation and the distribution of ambient temperatures.
 - (d) Derivation of the composite mission profile; including captive flight vibration measurements, temperature measurements, and thermal models.
 - (4) Test cycle. The test cycle defines the time history of the controlled and monitored variables and the performance of functional tests. The environmental test cycle is the product of a composite mission cycle and a climatic offset cycle.
 - (a) Composite mission cycle. This is a time history of the environmental and operating stresses to be imposed repeatedly at different offset climatic temperatures. All functional tests and other events such as shocks are identified in this time history. The duration, level, and other characteristics of

¹ Specified mission vibration spectra will be spectra to be replicated during vibro-acoustic testing. In replicating the spectra, combined vibration and acoustic excitation will be employed. The specification of mission acoustic spectra is of nominal importance since the in-service acoustic environment is not replicated directly.

MIL-STD-810H
METHOD 523.4

each stress are defined. Include in this cycle, transitional periods to normalize temperatures between climatic offsets.

- (b) Environmental profile charts. Use a chart (either graph or table) for each of the environmental variables to be controlled or monitored during the test that shows the intended value for the variable during the composite mission cycle. These charts will be for the standard-day diurnal temperature condition.
 - (c) Climatic offset table. Prepare a table of the temperature offsets in their order of application to successive composite mission cycles. Explain in the DETP the origin of these offsets and their scope (e.g., 95 percent worldwide). Also, include any transitional temperature conditioning periods between composite mission cycles.
 - (d) Test control method. Include in the DETP, the method to be used in controlling environmental stresses, the location and type of sensors, the use of open-loop or closed-loop control, and the tolerances for variables.
- (5) Test completion criteria. Specific statement of what constitutes a complete test (e.g., number or type of failures, number of test cycles completed, etc.).
- (6) Test log. Use a test log for written information and recording unusual events and anomalies. As a minimum, include the following:
- (a) Time that the test item(s) is installed in the test facility and the number of the first composite mission cycle thereafter.
 - (b) Calibration of instrumentation and apparatus.
- c. Tailoring. Necessary variations in the basic test procedures to accommodate LCEP requirements.

3.2 During Test.

Collect the following information while conducting the test:

- a. General. Information listed in Part One, paragraphs 5.10 and 5.12, and in Annex A, Tasks 405 and 406, of this standard.
- b. Specific to this method.
 - (1) A chronological record of events. Record all events that affect the test or interpretation of test results.
 - (2) A continuous record of environmental levels. Running record of all ambient and test environmental factors and levels. For example, room temperature and humidity, acoustic horns and shaker levels, skin and component temperatures, buffet events, shaker shock events, etc.
 - (3) A record of deviations. Chronological record of all deviations from intended levels and/or durations of test environments.
 - (4) Failure interpretation/disposition. Procedures for operations after failures occur, including fix, repair, and test restart.

3.3 Post-Test.

The following post test data shall be included in the test report.

- a. General. Information listed in Part One, paragraph 5.13, and in Part One, Annex A, Task 406 of this standard.
- b. Specific to this method.
 - (1) Test chronology. Listing of events, test interruptions, and test failures.
 - (2) Failure interpretation/disposition. Definitions of failures and failure categories. Procedures for operations after failures occur including fix, repair, and test restart.

MIL-STD-810H
METHOD 523.4

- (3) Test item disposition. Location, condition, and planned uses of the test item (e.g., returned to the manufacturer, held for further tests, etc.).

4. TEST PROCESS.

Ensure that the apparatus used to conduct the vibro-acoustic/temperature test on a store, hereafter referred to as a “test item,” includes the capability of inducing the required range of temperature and vibration while, at the same time, operating and monitoring the function of the test item. Include the following considerations.

4.1 Test Facility.

Ensure that the apparatus used to conduct the vibro-acoustic/temperature test includes the following:

4.1.1 General.

The capability to induce the required range of temperature and vibration while, at the same time, operating and monitoring the function of the test item.

4.1.2 Acoustic Chamber.

Combined application of mechanical vibration and acoustic noise is generally required to reproduce the specified vibration response of test items at the monitoring points. The mechanical input through a vibration shaker system generally supplies the energy at lower frequencies (below about 100 Hz). Acoustic pressures cannot be practically controlled at frequencies below 100 Hz where transmission of vibration energy by mechanical means is practical. Acoustic energy providing vibrational energy at monitoring points becomes the major source of such vibrational energy at higher frequencies (above roughly 300 Hz) where mechanical vibration transmission through complex mechanical connections becomes impractical. The range between these frequencies is driven by a mixture of vibration and acoustics. See Methods 514 and 515 for further guidance.

4.1.2.1 Acoustic Chamber and Acoustic Source.

Ensure the chamber shape and dimensions provide for a uniform distribution of the acoustic field at frequencies above 150 Hz (paragraph 6.1, reference i). The facility must be capable of producing the required levels of acoustic energy over the range 150 to 2500 Hz. While an acoustic level of 155 dB will sometimes suffice, much higher levels (up to 165 dB) are sometimes needed. This level must be attainable with the test item and other required equipment in the chamber. Because acoustic levels of these magnitudes are difficult to produce, careful planning is required to ensure that the chamber is capable of producing the required environment. Typical apparatus consists of electrically driven air modulators coupled to the chamber by exponential horns.

4.1.2.2 Vibration Equipment.

To induce the lower frequency part of the vibration and to simulate exceptional dynamic events, the test item may be driven by one or more electrodynamic or electrohydraulic exciters. Ensure attachment to the exciters does not interfere with the acoustic field or significantly change the natural frequencies of the test item. With large, complex shaped, or unbalanced test items (cruise missiles, electronic countermeasures stores, munition dispensers, etc.), this is likely to require multiple exciters driving a softly suspended store through rod-and-collar drive links. For small, slender test items (air-to-air missiles, etc.) this may sometimes be accomplished by driving the test item through its usual interface with an aircraft, e.g., launcher. However, even for such small, slender test items, a softly suspended test item driven through a rod-and-collar arrangement may be needed. Typically, electrodynamic exciters are used. In cases where there are high levels of vibration required at low frequency (e.g., buffet vibration), electrodynamic exciters may not be capable of producing the required amplitudes (particularly the high velocity and displacement amplitudes). In these cases electrohydraulic exciters may be the better choice. Electrohydraulic exciters are not capable of producing the high frequencies required in typical avionics vibration tests.

4.1.3 Temperature Equipment.

Ensure the range of temperatures and rate of change of the test item’s skin temperature is adequate to achieve the test profile. A typical range is -40 °C to +85 °C (-40 °F to +185 °F); the rate of change may be as high as 4 °C/min (7 °F/min). Temperature conditioning of the test item must be compatible with the acoustic field. In order to isolate the test item from the air in the acoustic chamber and the chamber walls, the test item may be enclosed in a thin, flexible shroud through which temperature conditioned air is ducted. This increases the thermal efficiency and permits high

MIL-STD-810H
METHOD 523.4

rates of temperature change. The shrouds must be transparent to the acoustic field. Making the shroud close fitting so as to raise the air speed around the test item enhances the heat transfer rate. Rip-stop nylon cloth has proven to be a suitable shroud material. Injection of liquid nitrogen is useful for achieving high rates of cooling. Air temperatures more extreme than the desired skin temperatures may be used to increase the heat transfer rate, but care must be taken to avoid creating excessive gradients along the surface.

4.1.4 Electrical Stress.

The operation duty cycle and the functional testing of the test item will provide the basic electrical stress. Cycle the test item on and off as dictated by the mission simulation. Correlate voltage variation or other electrical parameters with temperature. Reproduce additional electrical stresses such as voltage spikes, dropouts, and ripples if they are known to occur in service.

4.2 Instrumentation.

To meet the test environment specification, acceleration, acoustic pressure, and temperature will be the measurement variables, with acceleration the primary response monitoring variable. On occasion other environment measurement variables may be employed, e.g., to measure moisture or humidity. In these cases special consideration will need to be given to the equipment specification to satisfy the calibration, measurement, and analysis requirements. All measurement instrumentation must be calibrated to traceable national calibration standards (see Part One, paragraph 5.3.2). In addition, instrumentation to measure test item function may be required. In this case, obtain and adhere to suitable calibration standards. The measurement device and its mounting will be compatible with the requirements and guidelines provided in paragraph 6.1, reference j.

a. Accelerometer:

- (1) Frequency Response: A flat frequency response within ± 5 percent across the frequency range of interest is required.
- (2) Transverse sensitivity should be less than or equal to 5 percent.
- (3) Nearly all transducers are affected by high and low temperatures. Understand and compensate for temperature sensitivity deviation as required. Temperature sensitivity deviations at the test temperature of interest should be no more than $\pm 5\%$ relative to the temperature at which the transducer sensitivity was established.
- (4) Base Strain sensitivity should be evaluated in the selection of any accelerometer. Establishing limitations on base strain sensitivity is often case specific based upon the ratio of base strain to anticipated translational acceleration.

b. Microphone:

- (1) An amplitude linearity within 10 percent from 5 percent to 100 percent of the peak pressure amplitude required for testing.
- (2) A flat frequency response within ± 10 percent across the frequency range 10 – 10000 Hz.
- (3) Microphone and its mounting compatible with the requirements and guidelines in paragraph 6.1, reference j.

c. Temperature gage:

- (1) An amplitude linearity within 10 percent from 5 percent to 100 percent of the peak temperature amplitude required for testing.
- (2) A flat frequency response capable of detecting temperature rates at 50°C/min (90°F/min).
- (3) Temperature gage and its mounting compatible with the requirements and guidelines in paragraph 6.1, reference j.

d. Other Measurement Devices. Consistent with the requirements of the test.

e. Signal conditioning. Use only signal conditioning that is compatible with the instrumentation requirements on the test, and that is compatible with the requirements and guidelines provided in reference m. In

MIL-STD-810H
METHOD 523.4

particular, filtering of the analog voltage signals will be consistent with the time history response requirements (in general, demonstrable sharp filter rolloff at the bandpass filter cutoff frequencies for acceleration and acoustic pressure, linear phase from DC to the filter cutoff for temperature gage), and filtering will be so configured that anomalous data caused by amplifier clipping will not be misinterpreted as response data, i.e., input to the amplifier will be filtered, but not the amplifier output. For acceleration related to shock data, filtering will require a linear phase filter from DC to the filter cutoff.

- f. Special monitoring instrumentation concerns. To control the test it is desirable to apply information from all active instrumentation in a feedback loop. Specifically, any information that indicates an out-of-tolerance test stress (e.g., temperature too high) or an out-of-tolerance test item response (e.g., excessive current draw) is cause to stop the test and initiate an investigation to determine the cause. Paragraphs 4.3.3 to 4.3.8 provide guidance for functional, vibrational (acoustic plus mechanical), temperature, humidity and power monitoring/control to ensure the test requirements are met.
- (1) Functional monitoring.
 - (2) Vibration monitoring/control.
 - (a) Air modulators.
 - (b) Mechanical stimulus.
 - (3) Temperature monitoring/control.
 - (4) Humidity monitoring.
 - (5) Power monitoring.

4.3 Controls / Tolerances.

- a. Calibration. Ensure all environment measurement devices, e.g., accelerometers, microphones, thermal gages, have calibrations traceable as noted in Part One, paragraph 5.3.2. Verify calibration of the system with a calibration device before beginning the test procedure. If not available, provide a suitable method for verification of the appropriate response. After processing the measured response data from the calibration device and verifying that measurements are in conformance with the specifications, remove the calibration device and perform the test on the designated test item. Calibrate equipment to record the function of the test item according to the test item performance specification.
- b. Tolerances. For test validation and control of the test, use the environment measurement tolerances specified under the test procedure, and guidance provided in Method 514, paragraph 4.2.2. In cases in which these tolerances cannot be met, establish and document achievable tolerances and ensure they are agreed to by the cognizant engineering authority and the customer prior to initiation of the test. In any case, establish tolerances within the limitations of the specified measurement calibration, instrumentation, signal conditioning and data analysis procedures. Establish tolerances on equipment to record the functional performance of the test item according to the test item performance specification.

4.3.1 Test Interruption.

Test interruptions can result from two or more situations, one being from failure or malfunction of test chambers or associated test laboratory equipment. The second type of test interruption results from failure or malfunction of the test item itself during operational checks.

4.3.2 Interruption Due to Test Facility Malfunction.

- a. General. See Part One, paragraph 5.11 of this standard.
- b. Specific to this method.
 - (1) Undertest interruption. If an unscheduled interruption occurs that causes the test conditions to fall below allowable limits, note the immediate conditions of the test item (temperature, etc.) and the point in the composite mission cycle, and stop the test. Determine the root cause of the undertest condition (e.g., the store is not achieving the proper skin temperature because of a Temperature Conditioning Unit (TCU) failure, or the desired vibration response levels are not being met because an acoustic

MIL-STD-810H
METHOD 523.4

modulator valve assembly has failed). Take corrective action to get all test equipment in proper working condition. Return the test item to the required conditions prior to the interruption, and continue the test from that point.

- (2) **Overtest interruption.** If the test item is exposed to test conditions that exceed allowable limits, give the test item an appropriate physical examination and operational check (when practical) before resuming the test. This is especially true where a safety condition may exist such as with munitions. If a safety problem is discovered, the preferable course of action is to terminate the test and reinitiate it with a new test item. (If this safety problem is not so resolved and test item failure occurs during the remainder of the test, the test results may be considered invalid.) If no problem is identified, reestablish pre-interruption conditions and continue from the point where the test tolerances were exceeded.

4.3.3 Interruption Due to Test Item Operation Failure.

Failure of the test item(s) to function as required during operational checks presents a situation with several possible options.

- a. The preferable option is to replace the test item with a “new” one and restart from Step 1.
- b. A second option is to replace / repair the failed or non-functioning component or assembly with one that functions as intended, and restart the entire test from Step 1.

NOTE: When evaluating failure interruptions, consider prior testing on the same test item and consequences of such.

4.3.4 Functional Monitoring.

Monitor test item functions continuously during the test. This may consist of a simplified measurement of overall performance. If so, perform a full functional evaluation at least once per environmental cycle. Full functional evaluations are recommended at both the high and low temperatures and at maximum vibration. Failures may be intermittent, irreversible, or reversible with changes in the environment. Ensure procedures for dealing with indicated failures are clearly defined. Verify functions that cannot be verified in the environmental test chamber by removing and testing the store at short intervals as compared to its expected MTBF. Note that any statistical assessment of the store reliability must take into account the test interval (paragraph 6.1, reference k). Statistical test plans such as those in MIL-HDBK-781 (paragraph 6.1, reference l), usually assume continuous monitoring.

4.3.5 Vibration Monitoring and Control.

Vibration is induced both by the acoustic field and by mechanical shakers. Experimentally determine the vibration and acoustic inputs required to provide the required store response as in paragraphs a. and b. below. Once the required vibration input has been established, input control the vibration exciter(s) to this measured signal by closed loop automatic control system(s). This will provide greater test consistency than trying to control vibration exciters with feedback from response measurements. Monitor the response and when significant differences between measure and required responses are detected, stop the test and determine the cause. Looseness or wear in the vibration input train, problems with monitoring transducer mounting or wiring, and differences in response of nominally identical stores may significantly affect response (paragraph 6.1, reference m). In particular, instrumented stores that have experienced many hours of severe captive flight conditions and which are used to calibrate vibration tests may be considerably less responsive than a new test store.

- a. **Air modulators.** The acoustic field may be generated by air modulators supplied with low-pressure 239 kPa to 446 kPa (20 to 50 psig) air. These modulators are coupled to the reverberant chamber through exponential horns. Considerable acoustic power is required, so several modulators may be needed for one chamber. Horns having a lower cutoff frequency of approximately 200 Hz may be used. The drive signal to the modulators is shaped random noise; it may be supplied from a noise generator signal that is shaped by filtering or from a pre-recorded signal. The shape of the acoustic spectrum is determined by adjusting it to produce (approximately) the same vibration response in an instrumented store as the vibration response measured in captive carry of that store. Microphones monitor the acoustic level and spectrum. Refer to Method 515 for microphone placement, test level tolerances, and further guidance.

MIL-STD-810H
METHOD 523.4

- b. Mechanical stimulus. The drive signal to the electrodynamic and electrohydraulic shakers is shaped random noise; it may be supplied from a noise generator signal that is shaped by filtering or from a prerecorded signal. Determine the shape of the vibration spectrum by adjusting it to produce the same vibration response in an instrumented store as the vibration response measured in the captive carry environment of that store. Adjust the acoustic input first and maintain it during compensation of the shaker drive signal. After the shaker drive signal has been compensated so as to reproduce the desired response vibration, record the vibration spectra and levels at the shaker attachments to the store as secondary standards to be used during the test. During the test, monitor vibration level and spectra with accelerometers at these points along with the store response control points. Monitor these signals throughout the test. For closed loop control of the shakers use the vibration as measured at the shaker/drive system interface. When the shakers are used only to provide the low frequency portion of the vibration spectrum, closed loop control may not be necessary. Refer to Method 514 for test level tolerances and further guidance.

4.3.6 Temperature Monitoring and Control.

The temperature that defines the temperature test cycle is the store skin temperature that is measured and used for feedback control during the test. The air temperature may be driven to more extreme values (as much as 20 °C (36 °F)) beyond the store range) in order to increase the rate of transfer. Monitor the air temperature separately in order to avoid values outside this range. In developing the temperature cycle, measure the store skin temperature at several points to ensure even distribution of the temperature.

4.3.7 Humidity Monitoring.

Although humidity is not a controlled variable for Procedure I, the ducted airstream may be monitored for moisture content, either by dewpoint or relative humidity sensing. Moisture can collect on a store's surface when it has reached and holds a cold temperature that is below the dewpoint of warmer air following in the mission cycle. This is a normal and expected condition.

4.3.8 Power Monitoring.

Continuously monitor all electrical and other power inputs (e.g., hydraulic, compressed air) whether or not they are modified to simulated mission conditions. This monitoring provides an immediate indication of many types of failures and, with automatic controls, may serve to limit secondary failures.

4.4 Data Analysis.

- a. Use an analog anti-alias filter configuration on all digitized signals that will:
 - (1) not alias more than a five percent measurement error into the frequency band of interest.
 - (2) have linear phase-shift characteristics for the temperature gage and acceleration shock from DC to the upper band edge.
 - (3) have a uniform passband to within one dB across the frequency band of interest (see paragraph 4.2).
- b. In subsequent processing of the data, use any additional digital filtering that is compatible with the anti-alias analog filtering. In particular, additional digital filtering must maintain phase linearity for processing temperature gage data and any acceleration shock data.
- c. Analysis procedures will be in accordance with those requirements and guidelines provided in paragraph 6.1, reference j. If anomalies are detected, discard the potentially invalid measured response time history data.

4.5 Test Execution.

4.5.1 Preparation for Test.

- a. General. See Part One, paragraph 5.8.
- b. Unique to this method. Verify that environmental monitoring and measurement sensors are of an appropriate type and properly located to obtain the required test data.

MIL-STD-810H
METHOD 523.4**4.5.2 Pretest Checkout.**

The following steps describe in detail the pretest set-up and cycle check procedure. The purpose of the pretest set-up is to provide a level of confidence that the test specification can be met on a test item. In general, this pretest checkout will require adjustment of the vibration sources to provide the best reproduction of the in-service vibration. Vibration response is subject to the following three sources of error: spatial, spectral, and amplitude. Since it may not be possible to minimize all of these errors simultaneously, compromises between the three kinds of error must be based on technical analysis and judgment. To better define and understand the cause behind the source of errors, each error will be described briefly along with potential corrective measures to reduce the error. It is important to note that both the in-service measured and laboratory replicated vibro-acoustic fields are spatially non-homogeneous and highly random.

- a. Relative spatial acceleration amplitude. Because the in-service acoustic and vibration environment result from many sources that cannot be replicated in the laboratory, relative vibration levels at different locations within the test item may not correspond with measured relative vibration levels of the store at the same locations in service. Reduction of this error may require relocation of attachment shakers, use of multiple shakers, a reorientation with respect to the acoustic field (from directional horns), or selective application of acoustic damping material. In addition, the effectiveness of the acoustic field in inducing vibration may vary with the air temperature within the shrouds surrounding the test item. In general, the test set-up provides fewer degrees of freedom for exciting the test item than the degrees of freedom available for the store in service. It is important to note that cross spectra are not usually specified from in-service measured data, nor are they considered a control parameter for the test. To some extent, the input excitation from various sources is assumed to be uncorrelated.
- b. Spectral shape error. Because the in-service acoustic and vibration environment comes from many sources that cannot be replicated in the laboratory, the spectral shape at different locations within the test item may not correspond with the spectral shape of the test item at the same locations in service. This may be corrected by changing the spectrum of the acoustic and/or shaker drive signals or it may require changing the method of supporting the test item. Since cross spectra are not usually specified from in-service-measured data and are not considered a control parameter for the test, only limited correction may be possible.
- c. Amplitude error. For stationary random data, generally the amplitude distribution is assumed to be Gaussian. However, for in-service measured data, the distribution may be non-Gaussian – particularly for high-level maneuver events. The test setup should check the test item amplitude distribution to assure that it matches the in-service measured amplitude distribution. This means that particular care must be given to inherent shaker control system amplitude limiting; e.g., 3σ clipping. For replication of a given autospectral density estimate with Gaussian amplitude distribution, ensure the shaker control system truncation is at a value greater than three times the RMS level (because of the long test durations it is important to have accelerations that exceed three times the RMS level). In general, to replicate an autospectral density estimate with a non-Gaussian amplitude distribution, specialized shaker control system software is required.

4.5.3 Test Setup and Cycle Check Procedure.

- Step 1. Using an instrumented test item (not necessarily operable), assemble the test item and environmental apparatus into the planned configuration. If the planned test is based on in-service measured values, it is important that the sensors and their locations be identical to those used in these measurements. It is highly desirable that the identical test item used in the in-service measurements, with its instrumentation intact, be used in the test setup.
- Step 2. Install and calibrate all sensors. Concurrently, test the function of any automatic alarm or abort mechanisms.
- Step 3. Apply and adjust the acoustic stimulus to the minimum level. Verify the levels and spectral shape. Apply higher levels in steps until the required maximum is reached. Adjust the spectral shape as required at each level.

MIL-STD-810H
METHOD 523.4

- Step 4. Apply the adjusted acoustic stimulus at the lowest required level. Apply an arbitrary, low-level vibration stimulus. Measure vibration response and iteratively adjust the vibration drive signal to achieve the required responses.
- Step 5. Adjust both the acoustic and vibration stimuli to their maximum levels. Adjust the vibration drive signal and, if necessary, the acoustic drive signal until the highest required levels of vibration response are achieved.
- Step 6. Adjust acoustic and vibration stimuli to each of the required intermediate levels and measure the responses. If the responses at each level are reasonably close (engineering judgement required) to the required levels, maintain the calibrations for the highest response level and iterate to the other levels by changing the overall levels of the drive signals (accuracy of the simulation is more important at the higher levels). If response variation is strongly non-linear with the stimulus level, establish calibrations for each level.
- Step 7. Apply the maximum temperature stimulus to the store. Adjust the temperature controller and ducting to achieve the desired skin temperatures and rates of change. Ensure the distribution of temperature values over the skin is within tolerances as determined from the thermal model. Ensure that required temperature rates-of-change can be achieved.
- Step 8. Conduct a composite mission profile cycle, including power on/off and operational tests. Measure skin temperatures and correct any problems. Ensure that temperature rate-of-change requirements can be met. Repeat as necessary.
- Step 9. Run a composite mission temperature cycle and duty cycle at the highest offset and another at the lowest offset. Measure the skin temperatures and correct any problems. Repeat as necessary.
- Step 10. Place an operable test item into the test setup. Repeat Steps 1 and 2 if this is a test item not previously subjected to those steps.
- Step 11. Provide power to the test item as required and conduct a test of its function.
- Step 12. Repeat Step 11 with vibration applied, under high temperature and then under low temperature.

4.5.4 Procedure.

The following general procedure will vary depending on the test type conducted as shown in Table 523.4-I:

- Step 1. Prepare the test item in its test configuration as described in paragraph 4.5.3.
- Step 2. Verify the functional status of the test item.
- Step 3. Start the test using conditions specified in the test plan developed from test tailoring guidelines.
- Step 4. Conduct the test and monitor the operational status of the test item per paragraph 4.5.3.
- Step 5. If a test item failure occurs, refer to paragraph 4.3.3.
- Step 6. If a test interruption occurs, proceed according to the procedure called out in paragraph 4.3.1.
- Step 7. Continue the test until termination criteria are met according to the procedure called out in paragraph 3.1.b(5). Document the results for comparison with pretest data.

MIL-STD-810H
METHOD 523.4**Table 523.4-I. Typical applications.**

TEST TYPE	PURPOSE	APPLICATION	TYPE OF INFORMATION REQUIRED	
			FAILURE MODES	TIME TO FAILURE
Test, Analyze, and Fix (TAAF)	Reveal and correct design weaknesses	Development of a more reliable design prior to production.	Essential to induce potential service failures.	Not important
Reliability Demonstration	Show whether or not a design meets the specified reliability.	Start of production is usually based on a successful reliability demonstration.	Important only if the demonstration is unsuccessful.	Essential.
Screening	Reveal workmanship or component defects before a production unit leaves the factory, i.e., while repair is cheap.	Part of the manufacturer's internal testing to assure delivery of reliable units during production.	Essential to induce failures in defective areas; such failures should not then appear in service.	Not important.
Lot Acceptance	Estimate the MTBF of the lot units from the time to failure of a small sample.	Determination as to whether the lot is of acceptable quality.	Important only if the lot is rejected.	Essential that successive lot measures be consistent and comparable. Baseline similarity to service MTBF is desirable.
Source Comparison	Determine the relative reliability of units from the time to failure of a small sample.	Determination as to which of two sources should get the larger share of a production buy.	Important for improvements at the poorer source.	Only consistency comparability is essential.

5. ANALYSIS OF RESULTS.

In addition to the guidance provided in Part One, paragraphs 5.14 and 5.17, and Part One, Annex A, Tasks 405 and 406, the following information is provided to assist in the evaluation of the test results. If the test item failed the test, consider the following categories during analysis of results of this method:

- a. **Stress.** If a failure occurred, consider what the immediate failure may have been, e.g., fatigue, short circuit by particulate, etc.
- b. **Loading mechanism.** Determine the physical loading mechanism that led to failure and the total time or number of cycles to failure (e. g., structural dynamic resonant modes, mode shapes, stress distribution, static deformation due to temperature distribution, incursion of moisture, etc.).
- c. **Responsibility.** Whether or not the failure was in a contractor or government furnished part of the store; was the test being performed properly, or was there a test error, e.g., out of tolerance test conditions, that caused the failure.
- d. **Source.** Whether or not the failure was due to workmanship error, a design flaw, a faulty part, etc. This is actually an inverted way of deciding what corrective action is appropriate, since extraordinary workmanship or high-strength parts can overcome design flaws and designs can be changed to eliminate workmanship errors and/or to work with weaker parts.
- e. **Criticality.** Whether or not the failure would have endangered friendly forces, prevented tactical success, or required repair before delivering the store.

MIL-STD-810H
METHOD 523.4**6. REFERENCE/RELATED DOCUMENTS****6.1 Referenced Documents.**

- a. A. Dantowitz, G. Hirshberger, and D. Pravidlo, "Analysis of Aeronautical Equipment Environmental Failures," Air Force Flight Dynamics Laboratory, TR-71-32, May 1971.
- b. NATO STANAG 4370, Allied Environmental Conditions and Test Publication (AECTP) 230, Climatic Conditions.
- c. MIL-HDBK-310, Global Climatic Data for Developing Military Products. 23 June 1997.
- d. D. B. Meeker and Allan G. Piersol, "Accelerated Reliability Testing Under Vibroacoustic Environments in Reliability Design for Vibroacoustic Environments," American Society of Mechanical Engineers AMD Vol-9, New York, NY, 1974.
- e. R.G. Lambert, "Accelerated Fatigue Test Rationale," General Electric Co., NY, March 1980
- f. David Alan Bies, "A Review of Flight and Wind Tunnel Measurements of Boundary Layer Pressure Fluctuations and Induced Structural Response," NASA CR-626, Bolt Beranek and Newman Inc., for NASA Langley Research Center, Oct 1966.
- g. Jack M. Graham, "Summary of Missile Vibration Levels During Straight and Level Flight on Various Aircraft," Pacific Missile Test Center, Point Mugu, CA, EM-1030-008, August 1984.
- h. Michael G. Hatcher and James R. Bautch, "PRAT Thermal and Vibration Profile Development," Sverdrup Technology Inc. for Aeronautical Systems Division, Eglin AFB, January 1992.
- i. Terry Elliott, "Design Parameters of Reverberant Acoustic Chambers for Testing Air-Carried Missiles," TM-81-15, Pacific Missile Test Center, Point Mugu, CA, March 1981.
- j. Handbook for Dynamic Data Acquisition and Analysis, IEST-RD-DTE012.2, Institute of Environmental Sciences and Technology, Arlington Place One, 2340 S. Arlington Heights Road, Suite 100, Arlington Heights, IL 60005-4516; Institute of Environmental Sciences and Technology Website.
- k. Terry Elliott, "Impact of Periodic Functional Testing on Sequential Test Plans," TP-82-25, Pacific Missile Test Center, Point Mugu, CA, May 1982.
- l. MIL-HDBK-781, Reliability Test Methods, Plans, and Environments for Engineering, Development, Qualification, and Production, Handbook for, 1 April 1996.
- m. Michael T. Bunij, "SIDEWINDER Manufacturer Dependent Vibration Response Investigation," Pacific Missile Test Center, Point Mugu, CA, June 1989.
- n. U.S. Standard Atmosphere, 1976; DTIC No. ADA035728.
- o. D. F. Rex ed. "World Survey of Climatology," Elsevier, NY, 1969.
- p. Sharon A. Ogden, "A Mathematical Method for Determining Laboratory Simulation of the Captive Flight Vibration Environment," Proceedings of the 48th Shock and Vibration Symposium, Huntsville, AL, 1977.

6.2 Related Documents.

- a. Egbert, Herbert W. "The History and Rationale of MIL-STD-810 (Edition 2)," January 2010; Institute of Environmental Sciences and Technology, Arlington Place One, 2340 S. Arlington Heights Road, Suite 100, Arlington Heights, IL 60005-4516

(Copies of Department of Defense Specifications, Standards, and Handbooks, and International Standardization Agreements are available online at <https://assist.dla.mil>.)

Requests for other defense-related technical publications may be directed to the Defense Technical Information Center (DTIC), ATTN: DTIC-BR, Suite 0944, 8725 John J. Kingman Road, Fort Belvoir VA 22060-6218, 1-800-225-3842 (Assistance--selection 3, option 2), <http://www.dtic.mil/dtic/>; and the National Technical Information Service (NTIS), Springfield VA 22161, 1-800-553-NTIS (6847), <http://www.ntis.gov/>.

MIL-STD-810H
METHOD 523.4, ANNEX A

METHOD 523.4, ANNEX A

PHILOSOPHY OF TESTING, VIBRO-ACOUSTIC/TEMPERATURE TEST PROFILE DEVELOPMENT

1. SCOPE.

1.1 Purpose.

This annex provides an example of the development of a Vibro-Acoustic/Temperature test profile.

1.2 Application.

Information in this annex is designed to provide some, but not necessarily all, of the details that must be considered in developing a Vibro-Acoustic/Temperature test profile. Information included here should allow the practitioner to develop the test profile for any of the possible test types provided in Table 523.4-I.

2. DEVELOPMENT.

2.1 Background.

In order to ensure that the failures occurring in a test are typical of in-service use, it is important to reproduce the service stress distribution. The service stress distribution is the set of stresses in the combinations, levels, and duration imposed by the in-service missions. The procedure reproduces the levels, durations, and combinations of temperature, vibration, and acoustic noise in the same relative proportions as the in-service missions.

2.2 General.

Military aircraft service use may be described by a set of missions and the relative frequency of occurrence of each mission as illustrated in Table 523.4A-I. Each mission is defined by the type of stores carried and a mission flight profile. The mission flight profile is an idealized mission history that describes altitude, speed, and various events (e.g., air combat, gunfire, refueling) as functions of time. From the mission profiles and climatic data, derive corresponding mission environmental profiles. Use data from instrumented flights in this derivation, if available. Once the mission environmental profiles are derived, they can be combined into a composite mission profile. The composite mission profile is a sequence of environments in which the various stresses and combinations of stresses occur in (approximately) the same proportion as in all of the mission environmental profiles weighted according to their relative frequency of occurrence. The composite mission profile also includes the effects of climatic temperatures according to their relative frequency. However, the composite mission profile must be short enough to be repeated many times (at least five times is recommended) within the expected time-to-failure of the store being tested. This may require that extreme environments (particularly extreme temperatures) not be included, since keeping them in proper proportion might result in too long a composite mission. Typically, the range of stresses included is between the 5th and 95th percentile.

Table 523.4A-I. Relative frequency of occurrence of mission types.

MISSION TYPE	AIRCRAFT TYPE	% OF SORTIES
1. Patrol Mission I	Fighter A	50
	Fighter B	30
2. Patrol Mission II	Fighter A	20
	Fighter B	20
3. Strike Escort Mission	Fighter A	30
	Fighter B	30
4. Strike Mission	Fighter B	20

2.3 Mission Characterization.

The first step in developing the composite mission profile is to determine the types of aircraft and mission flight profiles that will employ the store. The mission flight profiles may be described in terms of altitude and Mach number with annotation of events. A tabulated mission phase analysis or mission profile description is shown in Table 523.4A-II. A corresponding graphical representation of this mission is shown on Figure 523.4A-1. The relative frequency of occurrence of the various missions must also be determined. This may be tabulated as shown in

MIL-STD-810H
METHOD 523.4, ANNEX A

Table 523.4A-I. In determining the relative frequency with which the store will be carried on various missions, it may be necessary to consider some state of hostility. Experience has shown that weapons that would be expended on their first flight in conflict may be subjected to many flights during a time of high international tension in which there is no combat. Choose the most stressful, yet realistic, mix of missions for simulation. Generally, it is not desirable to average together relatively benign missions with relatively stressful ones if a store will experience only one or the other during its service life. For each aircraft type and mission, determine the carriage location of the store to be tested, as well as the location of other stores that may affect it. Stores located ahead of or adjacent to a given store will cause an increase in the turbulence-induced vibration of that store. Ejection of nearby stores may also induce dynamic loads. Also, note any geographic or other conditions that would influence the mission (e.g., a store carried only by carrier-based aircraft will not experience as wide a range of preflight temperatures as one carried by land-based aircraft).

Table 523.4A-II. Mission phase analysis (Fighter B, strike mission).

MISSION PHASE	MACH NUMBER	ALTITUDE (km)	DURATION (min.)	ADDITIONAL FACTORS	DUTY CYCLE OF STORE
Takeoff & Climb				Catapult Shock?	Off to Ready
Cruise					Ready
Refuel					Ready
Ingress					On (Radiate)
Attack				Buffet?	Ready
Return					Ready
Refuel					Ready
Descend & Land				Landing Shock?	Off

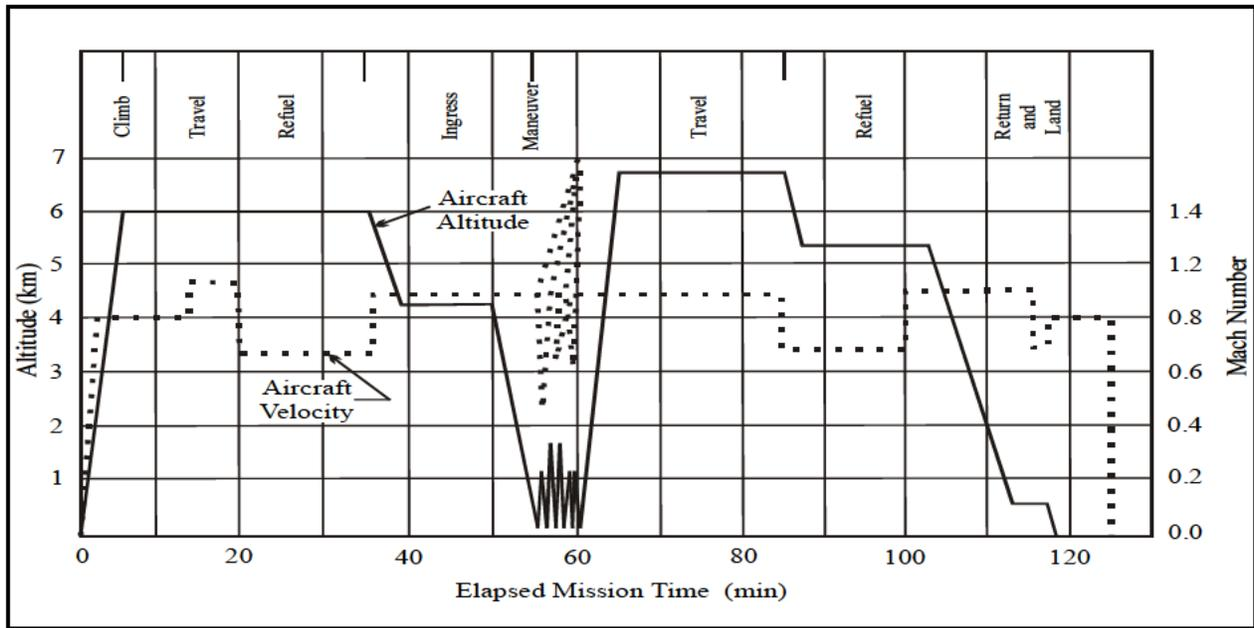


Figure 523.4A-1. Typical aircraft operational mission profile.

2.4 Mission Analysis.

Rather than deriving store environments such as vibration directly from the mission profiles, first recast the mission profiles in terms of the variables that directly affect the store, but which do not depend on the store's response.

MIL-STD-810H
METHOD 523.4, ANNEX A

These variables are initial temperature, recovery air temperature, and dynamic pressure. It is assumed that the store's temperature and vibration are a function of these primary variables.

2.4.1 Mission Temperatures.

Standard-day recovery air temperatures may be calculated from the equation in paragraph 2.1.1.4 and Method 514.8, Annex D, Table 514.8D-V, given the flight speed and pressure altitude (h) (standard atmosphere). Table 514.8D-V can also be used to convert various measures of air speed to Mach number. The temperature profile for a single mission type is provided on Figure 523.4A-2. For a composite mission, Figure 523.4A-3 displays the skin temperature versus the elapsed mission time.

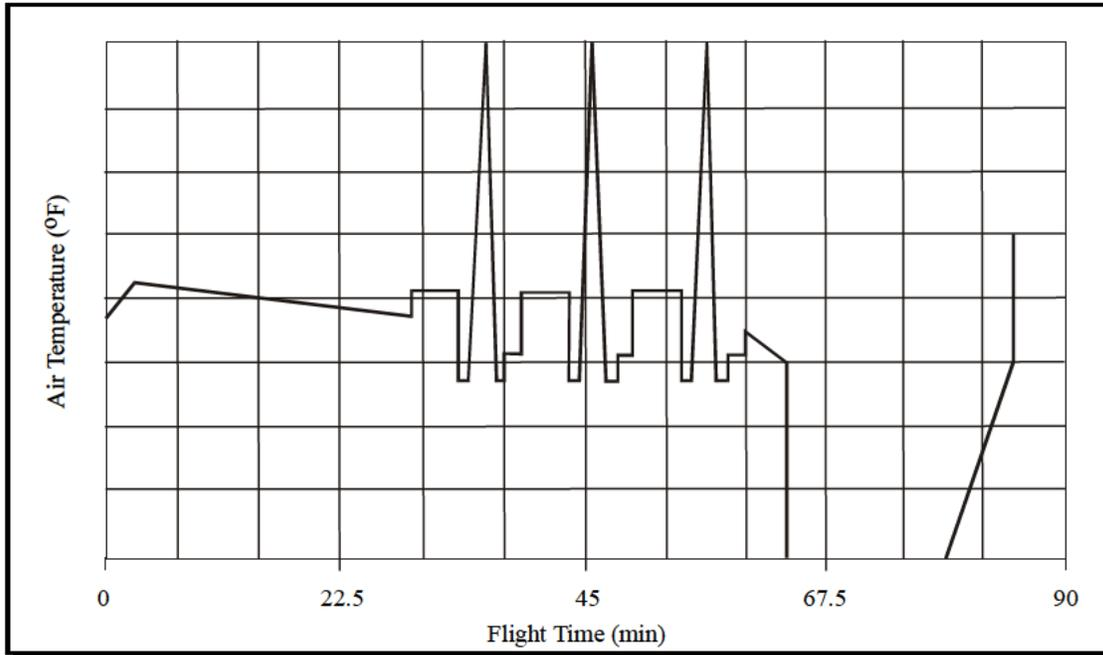


Figure 523.4A-2. Temperature profile for a single mission type.

MIL-STD-810H
METHOD 523.4, ANNEX A

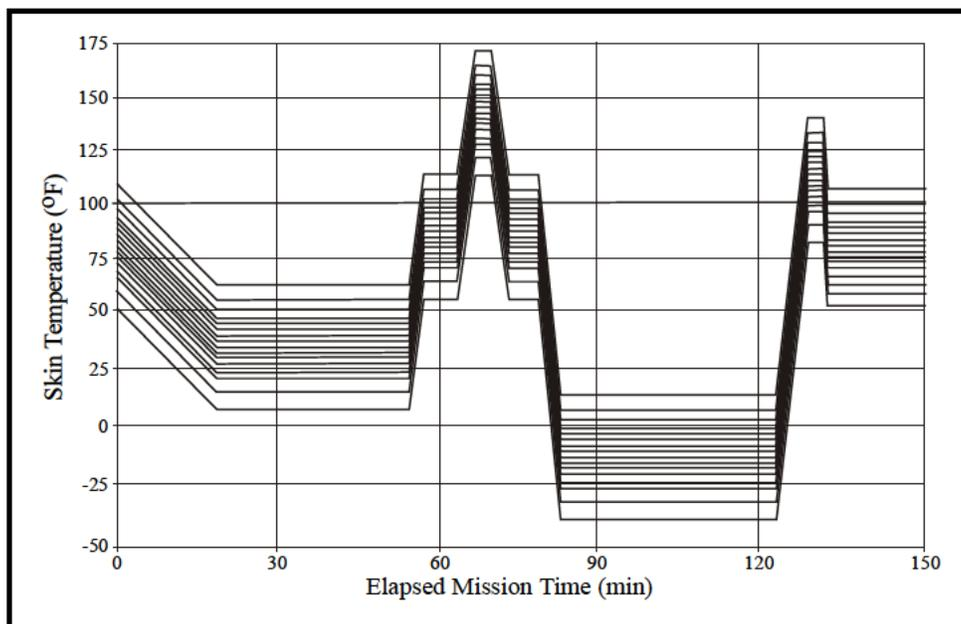


Figure 523.4A-3. Climatic set of temperature profiles for composite mission.

2.4.2 Mission Vibration.

- a. Both the frequency spectrum shape and spatial distribution of store vibration in captive flight are almost independent of the flight condition. Exceptions are increased low frequency vibration during buffeting maneuvers and, in some cases, increased high frequency vibration in supersonic flight. In general, boundary layer fluctuating pressures are proportional to the dynamic pressure (q) of the flight condition. The store vibration is the dynamic response of the store to these pressures and is also proportional to q . The vibration spectrum rms level (grms) is proportional to q , and the acceleration spectral density (G) at any frequency is proportional to q^2 . If vibration levels ($grms_{ref}$, G_{ref}) are defined for a single flight condition (q_{ref}), this proportionality can be used to approximate vibration levels throughout the flight envelope as follows:

$$\frac{grms}{grms_{ref}} = \frac{q}{q_{ref}} \quad \text{and} \quad \frac{G}{G_{ref}} = \left(\frac{q}{q_{ref}} \right)^2$$

where:

q = dynamic pressure, kN/m^2 (lb/ft^2)

grms = spectrum rms vibration level, g

G = acceleration spectral density, g^2/Hz

The area under the $G(f)$ curve is the square of the grms level

- b. Usually the reference condition is taken to be subsonic carriage on the least stressful aircraft station (wing pylon with no adjacent stores). Using this reference, determine the q versus time profile for each mission and construct a histogram representing the proportion of time the store is at a q level. This summarizes the expected vibration experience of the store. For stores for which measured vibration data are not available, the levels can be estimated by considering similar stores, with tailoring criteria provided in Method 514.8. Paragraph 6.1, reference g is a summary for various air-launched missiles.
- c. For the missions where the store is carried on stations other than the least stressful station, adjustment factors may be needed. These factors typically account for cases where stores are carried side by side, behind other stores or in other special configurations. Measured data are the best source for these factors. Method 514.8 also provides guidance.

MIL-STD-810H
METHOD 523.4, ANNEX A

- d. Vibration of a store is the dynamic response of the store to the fluctuating pressure and aircraft transmitted environments. This is broken down into definitions of the motions of key structural points of the store. The vibration environments of materiel located in the store are the local store vibration responses. The test consists of exciting the store with arbitrary levels of vibration and acoustics, and tailoring these inputs to achieve the defined store responses.
- e. For the exceptional cases (aircraft buffet, catapult launch, arrested landing, gunfire, etc.), determine vibration/shock level, spectrum, and other characteristics. Quantify the occurrences of the exceptional vibration/shock conditions in terms of duration and mission time, so they can be reproduced in the proper proportions and at the proper times in the test cycle. Measured data are even more important here, but Method 514.8 contains guidance both for interpreting measured data and estimating levels when necessary. Method 519.8 contains guidance on estimating gunfire-induced shock.

2.4.3 Test Temperature Profile.

The test temperature profile will be the product of two parts: one that simulates the range and variation of temperature due to the missions, and another that simulates the climatic effects:

- a. To determine the mission simulation part, begin with a sequence of skin temperatures corresponding to a few of the most common mission(s) strung together. Use a sequence that is no longer than one fortieth (1/40) of the store MTBF. It is usually convenient to make it a factor of 24 hours (e.g., 6 hrs or 8 hrs) since the test will be run around-the-clock. Use this skin temperature as an input to the store thermal model and determine the histograms of the internal temperature. These must be the responses after many cycles (the "steady state" responses). Compare these to the histograms for all the missions. Adjust the test sequence to achieve approximate agreement between the temperature histograms, both on the skin and internally. In this adjustment, keep the number and rate of temperature changes roughly the same as in the actual missions. It will usually be necessary to introduce a period of simulated on-the-ground time into the cycle in order that each simulated flight period start with the store at the appropriate uniform temperature. The temperature during the simulated on-the-ground time may be elevated or reduced in order to speed up the stabilization of internal temperatures. This initial temperature will be shifted each cycle to simulate the effect of climatic temperature variation.
- b. Climatic effects are included by repeating the simulated flight cycle with temperatures shifted up or down by offset values that are constant over one cycle, but which differ from cycle to cycle (see Table 523.4A-III). Successive cycles have the temperature raised or lowered by an amount that represents a colder or hotter than standard day. Ensure the number of different offsets is at least eight. The upper bound on the number of offsets is determined by the requirement that the overall cycle must be shorter than one fifth of the MTBF. The value of the N offsets is chosen to be the midpoints of the N equi-probable intervals of the climatic temperature distribution as shown on Figure 523.4A-4. For worldwide, day and night operations, the climatic variation below 10 km is well approximated by a Gaussian distribution; at ground level; the mean is 12 °C and the standard deviation is 15 °C (paragraph 6.1, reference h). (This includes variation of location as well as season.) At altitude, the mean temperature is lower, but the standard deviation is about the same (paragraph 6.1, references h and n) over most of the globe. Near the poles and the equator, the variation at altitude is considerably less (paragraph 6.1, reference o). For eight offsets, the temperatures would be as shown in Table 523.4A-III. Stair-step the sequence of offsets in the test cycle up and down as indicated by the step number. Figure 523.4A-5 displays a climatic set plan where test item skin temperature is a function of elapsed test time. This reduces the duration required between offsets to normalize the store temperature for the next offset. It is desirable to minimize this duration since it does not count in measuring the store MTBF and hence decreases the test efficiency.

MIL-STD-810H
METHOD 523.4, ANNEX A

Table 523.4A-III. Temperature offsets.

STEP	PERCENTILE	OFFSET	GROUND TEMPERATURE
3	6.25	-30.8°C	-18.8°C (-2°F)
2	18.75	-13.3°C	-1.3°C (30°F)
4	31.25	-7.2°C	4.8°C (41°F)
1	43.75	-2.4°C	9.6°C (49°F)
5	56.25	+2.4°C	14.4°C (58°F)
8	68.75	+7.2°C	19.2°C (67°F)
6	81.25	+13.3°C	25.5°C (78°F)
7	93.75	+30.8°C	43.0°C (109°F)

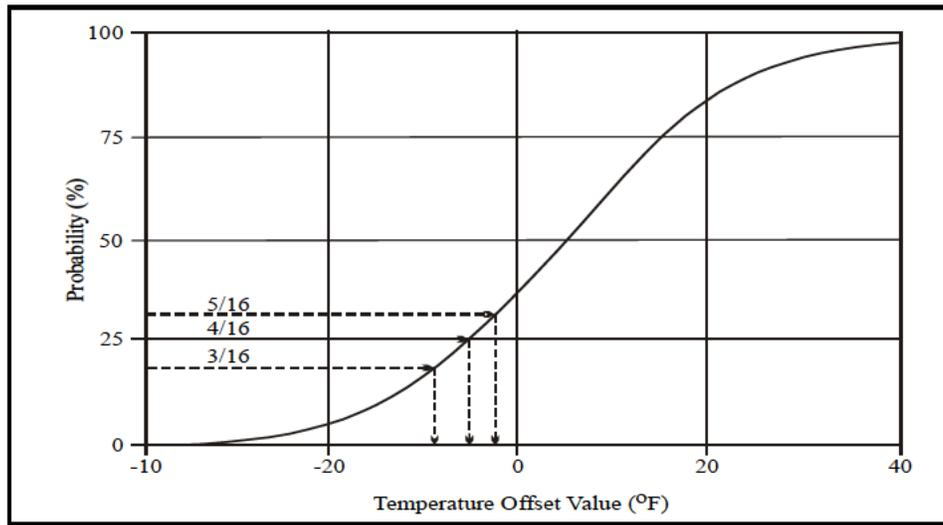


Figure 523.4A-4. Selection of equi-probable temperatures from the cumulative distribution of climatic temperatures.

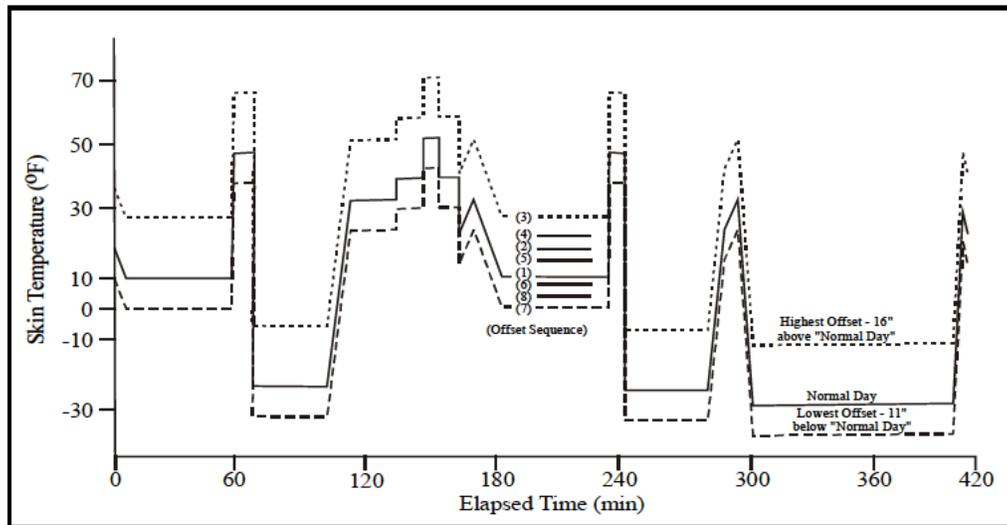


Figure 523.4A-5. Climatic set plan showing offset sequences.

MIL-STD-810H
METHOD 523.4, ANNEX A

2.4.4 Test Vibration Profile.

Ensure the test vibration profile produces the same histogram of store response levels as that derived from the mission analysis. Analyses assuming power function fatigue damage indicate that three to five different vibration levels are usually enough (paragraph 6.1, reference p). Use the same mission sequence used for the initial temperature cycle to generate a vibration level test cycle. This can then be adjusted to achieve the correct overall histogram. Maintain correlation between vibration and temperature (usually high vibration level goes with high temperature) as in the actual missions. Insert the exceptional vibration events into the test cycle with proportionate duration, and in realistic combination with the temperature and the straight and level vibration. Usually it is desirable to test the function of the store under the more severe part of the test environment, since that is the most likely to reveal reversible failures. In service, high levels of vibration, such as those due to buffet, usually occur over several very short time intervals, on the order of a few seconds. It may be desirable to conjoin all the high level vibration corresponding to a few mission-hours into a single interval in order to allow time for a complete test of the store's function during the high level vibration. Figure 523.4A-6 displays dynamic pressure, q , in terms of absolute pressure, P_a , versus elapsed mission time for a composite mission.

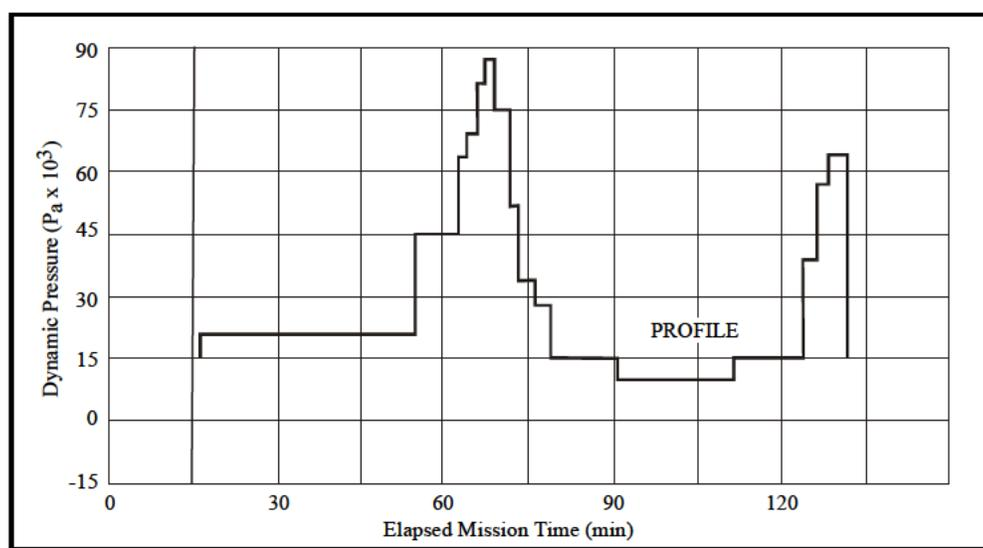


Figure 523.4A-6. Dynamic pressure, q , profile for composite mission.

2.4.5 Operational Duty Cycle.

Consider the operational duty cycle of the store in the temperature test design since power dissipation is a source of heat. Additionally, arrange it to allow functional test of the store during stressful parts of the cycle, as well as benign parts. If possible, test the store at low and high temperature extremes, during or immediately after high level vibration and at the beginning of each cycle.

3. TEST CONFIGURATION.

Figure 523.4A-7 is a schematic of the arrangements of a typical set of apparatus for performing a vibro-acoustic/temperature test. This arrangement consists of a control room that may be remotely located from a hardware test chamber termed an acoustic cell. The electrodynamic or electrohydraulic shakers are hidden under the test items.

MIL-STD-810H
METHOD 523.4, ANNEX A

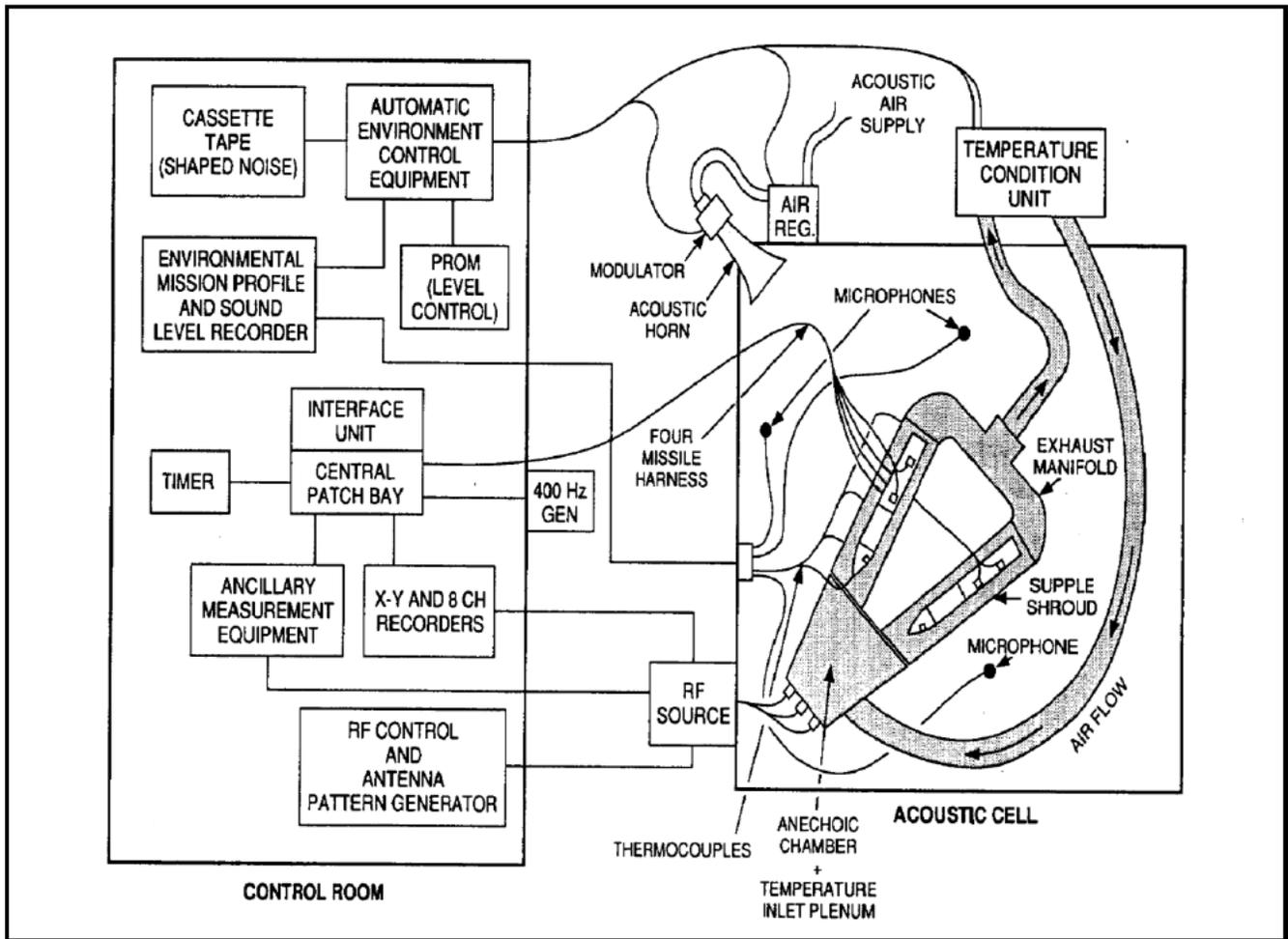


Figure 523.4A-7. Typical arrangement of test apparatus.

MIL-STD-810H
METHOD 524.1**METHOD 524.1**
FREEZE / THAW**CONTENTS**

<u>Paragraph</u>	<u>Page</u>
1. SCOPE	1
1.1 PURPOSE	1
1.2 APPLICATION	1
1.3 LIMITATIONS.....	1
2. TAILORING GUIDANCE	1
2.1 EFFECTS OF THE ENVIRONMENT.....	1
2.2 TEST PROCEDURES.....	1
2.2.1 PROCEDURE I - DIURNAL CYCLING EFFECTS.....	2
2.2.2 PROCEDURE II - FOGGING	2
2.2.3 PROCEDURE III - RAPID TEMPERATURE CHANGE.....	2
2.3 DETERMINE TEST LEVELS AND CONDITIONS	2
2.3.1 TEST ITEM CONFIGURATION	2
2.3.2 TEMPERATURE RANGE.....	2
2.3.3 MOISTURE.....	2
2.3.4 NUMBER OF CYCLES	2
3. INFORMATION REQUIRED.....	3
3.1 PRETEST.....	3
3.2 DURING TEST.....	3
3.3 POST-TEST	3
4. TEST PROCESS	3
4.1 TEST FACILITY	3
4.2 CONTROLS	4
4.3 TEST INTERRUPTIONS.....	4
4.3.1 INTERRUPTION DUE TO CHAMBER MALFUNCTION	4
4.3.2 INTERRUPTION DUE TO TEST ITEM OPERATION FAILURE	4
4.4 TEST EXECUTION	4
4.4.1 PREPARATION FOR TEST.....	4
4.4.1.1 PRELIMINARY STEPS	4
4.4.1.2 PRETEST STANDARD AMBIENT CHECKOUT.....	4
4.4.2 PROCEDURE I - DIURNAL CYCLING EFFECTS.....	5
4.4.3 PROCEDURE II - FOGGING	5
4.4.4 PROCEDURE III - RAPID TEMPERATURE CHANGE.....	5
5. ANALYSIS OF RESULTS	6
6. REFERENCE/RELATED DOCUMENTS	6
6.1 REFERENCED DOCUMENTS.....	6
6.2 RELATED DOCUMENTS.....	6

MIL-STD-810H
METHOD 524.1

(This page is intentionally blank.)

MIL-STD-810H
METHOD 524.1

METHOD 524.1
FREEZE / THAW

NOTE: Tailoring is essential. Select methods, procedures and parameter levels based on the tailoring process described in Part One, paragraph 4.2.2, and Annex C. Apply the general guidelines for laboratory test methods described in Part One, paragraph 5 of this Standard.

1. SCOPE.

This method was adapted from NATO STANAG 4370, AECTP 300, Method 315.

1.1 Purpose.

The purpose of this Method is to determine the ability of materiel to withstand:

- a. The effects of moisture phase changes between liquid and solid, in or on materiel, as the ambient temperature cycles through the freeze point.
- b. The effects of moisture induced by transfer from a cold-to-warm or warm-to-cold environment.

1.2 Application.

This Method is applicable to materiel that will experience one or more excursions through the freeze point while wet or in the presence of moisture (free water or vapor). See paragraph 2.1 for specific examples. For additional information, see Part Three, paragraph 5.9.

1.3 Limitations.

This Method is not intended to evaluate the effects of low temperature, thermal shock, rain, or icing. These may be determined using Methods 502.7, 503.7, 506.6, and 521.4, respectively.

2. TAILORING GUIDANCE.

2.1 Effects of the Environment.

This Method induces physical changes in or on non-stationary materiel. Examples of problems that could occur during these tests are as follow:

- a. Distortion or binding of moving parts.
- b. Failure of bonding materials.
- c. Failure of seals.
- d. Failure of materials due to freezing/re-freezing of absorbed, adjacent, or free water.
- e. Changes in characteristics of electrical components.
- f. Electrical flashover/reduced insulation resistance.
- g. Fogging of optical systems during freeze-thaw transitions.
- h. Inability to function correctly due to ice adhesion and interference or blockage of moving parts.

2.2 Test Procedures.

When a freeze/thaw test is thought necessary, the three procedures included in this Method are suitable for most materiel:

MIL-STD-810H
METHOD 524.1**2.2.1 Procedure I – Diurnal Cycling Effects.**

To simulate the effects of diurnal cycling on materiel exposed to temperatures varying slightly above and below the freeze point that is typical of daytime warming and freezing at night when deposits of ice or condensation, or high relative humidity exist. For Procedure I to be effective, frost must form on the test item surfaces during the temperature increase through the freeze point, and then melt just prior to re-freezing.

2.2.2 Procedure II – Fogging.

For materiel transported directly from a cold to a warm environment such as from an unheated aircraft, missile or rocket, to a warm ground area, or from a cold environment to a warm enclosure, and resulting in free water or fogging.

NOTE: Tests for fogging are only appropriate for materiel designed to not fog or that has built-in de-fogging capabilities.

2.2.3 Procedure III – Rapid Temperature Change.

For materiel that is to be moved from a warm environment to a cold environment (freeze) and then back to the warm environment, inducing condensation (free water).

2.3 Determine Test Levels and Conditions.

Specify the most significant parameters for this Method such as temperature, moisture level/form, test item configuration (operational or storage), and the number of freeze/thaw cycles.

2.3.1 Test Item Configuration.

Perform the test using all the configurations in which the materiel may be placed during its life cycle. As a minimum, consider the following configurations:

- a. In a shipping/storage container or transit case.
- b. Protected or not protected.
- c. In its operational configuration.
- d. Modified with kits for special applications.

2.3.2 Temperature Range.

Use temperatures within the storage or operational range of the test item. Normally, the temperature cycle ranges between +5 °C and -10 °C (41 °F and 14 °F) for diurnal cycling effects, and -10 °C (14 °F) to standard ambient (Part One, paragraph 5.1), but these vary as required to achieve the desired effects.

2.3.3 Moisture.

Use water needed to create the test moisture from local (clean) water sources. Apply the moisture as a water vapor or as free water (spray).

2.3.4 Number of Cycles.

A cycle is a change from one thermal-moisture condition to another and back to the original condition. Unless otherwise specified in the test procedure(s), hold the test item at each condition for a minimum of one hour following test item temperature stabilization. Unless otherwise justified by the materiel's life cycle profile, apply the following minimum number of cycles:

- a. Diurnal cycling effects (daily freeze-thaw): Minimum of twenty (see Part Three, paragraph 5.9a, and paragraph 6.1, reference c).
- b. Cold-to-warm transfer (for free water or possible fogging): Three.
- c. Warm-cold-warm (for freezing and melting, rapid temperature change): Three.

MIL-STD-810H
METHOD 524.1**3. INFORMATION REQUIRED.**

In addition to the information derived from Part One, apply a brief scenario of service conditions to explain the intended simulation. Also state:

- a. The type of moisture required (vapor or spray).
- b. The initial test conditions and the temperatures to be used.
- c. Whether the test is a demonstration of survival or of functional performance.
- d. The number of cycles to be used.

3.1 Pretest.

The following information is required to adequately conduct freeze/thaw tests.

- a. General. Information listed in Part One, paragraphs 5.7 and 5.9; and Annex A, Task 405 of this Standard.
- b. Specific to this Method.
 - (1) Low temperature extreme and time at that temperature.
 - (2) Rate of temperature rise.
 - (3) Means of introducing moisture using water vapor.
 - (4) Number of cycles.
- c. Tailoring. Necessary variations in the basic test procedures to accommodate LCEP requirements.

3.2 During Test.

Collect the following information during conduct of the test:

- a. General. Information listed in Part One, paragraph 5.10; and in Annex A, Tasks 405 and 406 of this Standard.
- b. Specific to this Method. For test validation purposes, record deviations from planned or pre-test procedures or parameter levels, including any procedural anomalies that may occur. Include:
 - (1) The transfer times between chambers (door open to door close).
 - (2) Conditions at which frost forms.

3.3 Post-Test.

The following post-test data shall be included in the test report.

- a. General. Information listed in Part One, paragraph 5.13; and in Annex A, Task 406 of this Standard.
- b. Specific to this Method.
 - (1) Length of time for visual examination and performance checks.
 - (2) Results of visual and operational checks (during and after testing).
 - (3) Location of any free water on or in the test item.

4. TEST PROCESS.

See Part One for test facility, test conditions, and test control information.

4.1 Test Facility.

In addition to the requirements specified in Part One, recommend using two chambers for Procedures II and III in order to simulate the sudden temperature changes often associated with movement between outside ambient and indoor conditions. Either a single chamber or combination of chambers is acceptable, as long as the test procedure requirements are satisfied.

MIL-STD-810H
METHOD 524.1**4.2 Controls.**

- a. Temperature. Unless otherwise specified in the test plan, if any action other than test item operation (such as opening the chamber door) results in a significant change of the test item temperature (more than 2 °C (3.6 °F)), re-stabilize the test item at the required temperature before continuing. If the operational check is not completed within 15 minutes, reestablish the test item temperature conditions before continuing.
- b. Rate of temperature change. Unless otherwise specified, control the rate of temperature change to not exceed 3 °C (5.4 °F) per minute to prevent thermal shock.
- c. Temperature measurement. Install temperature sensor instrumentation on or in the test item to measure temperature stabilization data (see Part One, paragraph 5.4).
- d. Temperature recording. Continuously record the chamber and test item temperature, if required.

4.3 Test Interruptions.**4.3.1 Interruption Due To Chamber Malfunction.**

Test interruptions can result from two or more situations, one being from failure or malfunction of test chambers or associated test laboratory equipment. The second type of test interruption results from failure or malfunction of the test item itself during operational checks.

- a. General. See Part One, paragraph 5.11 of this Standard.
- b. Specific to this Method. Interruption of a freeze-thaw test is unlikely to generate any adverse effects. Normally, continue the test from the point of interruption once the test conditions have been re-established.

4.3.2 Interruption Due To Test Item Operation Failure.

Failure of the test item(s) to function as required during mandatory or optional performance checks during testing presents a situation with several possible options.

- a. The preferable option is to replace the test item with a “new” one and restart from Step 1.
- b. A second option is to replace / repair the failed or non-functioning component or assembly with one that functions as intended, and restart the entire test from Step 1.

4.4 Test Execution.**4.4.1 Preparation for Test.****4.4.1.1 Preliminary Steps.**

Before starting the test, review pretest information in the test plan to determine test details (e.g., procedures, test item configuration/orientation, cycles, durations, parameter levels for storage/operation, etc.). (See Part One, paragraph 5.9, and paragraph 3.1, above.)

4.4.1.2 Pretest Standard Ambient Checkout.

- Step 1 Remove unrepresentative coatings/deposits and contaminants such as oils, grease and dirt that could affect the adhesion of ice to the specimen surface.
- Step 2 Ensure any fluids contained in the test item are compatible with the temperatures used in the test.
- Step 3 Install temperature sensors in, on, or around the test item (as described in the test plan) to measure temperature stabilization and surface temperatures.
- Step 4 Place the test item in the test chamber at standard ambient conditions and in the required configuration.
- Step 5 Conduct a visual examination of the test item with special attention to stress areas, such as corners of molded cases, and document the results.
- Step 6 Conduct an operational checkout (Part One, paragraph 5.8.2) as described in the plan and record the results.

MIL-STD-810H
METHOD 524.1

- Step 7 If the test item operates satisfactorily; proceed to paragraph 4.4.2, 4.4.3, or 4.4.4 as appropriate. If not, resolve the problems and repeat Step 6 above.

4.4.2 Procedure I – Diurnal Cycling Effects.

- Step 1 Spray the test item sufficient to fill any horizontal pockets to simulate water collected during a rain storm.
- Step 2 Reduce the temperature inside the chamber to -10 °C (14 °F) or as otherwise specified for the initial conditions at a rate not exceeding 3 °C (5 °F) per minute. Maintain the condition for a minimum of one hour after the test item temperature has stabilized.
- Step 3 Increase the chamber temperature to 4 °C (39 °F) over a period of three hours. When the chamber air temperature reaches 0 °C (32 °F), introduce moisture using water vapor, steam, vapor generator or other means to raise and maintain the humidity at or close to saturation.
- Step 4 When the test item surface temperature reaches 0 °C (32 °F), ensure frost has formed on the test item surfaces.
- Step 5 Continue raising the test chamber towards a test item surface temperature of 4 °C (39 °F) (water at maximum density) until the frost just melts, then reduce the temperature to -10 °C (14 °F) over a period of three hours. Maintain the conditions for a minimum of one hour following test item temperature stabilization.
- Step 6 Repeat Steps 3 through 5 for a total of twenty cycles unless otherwise specified.
- Step 7 Maintain the chamber and test item at the low temperature conditions until a visual examination and/or operational checks have been completed. If the test item fails to operate as intended, follow the guidance in paragraph 4.3.2. Otherwise go to Step 8.
- Step 8 Return the test item to standard ambient conditions. Perform a complete visual and operational check, and document the results. See paragraph 5 for analysis of results.

4.4.3 Procedure II – Fogging.

- Step 1 Adjust the chamber temperature to 10 °C (18 °F) below the freezing point or as otherwise specified for the initial conditions at a rate not exceeding 3 °C (5 °F) per minute. Maintain the condition until the test item temperature has stabilized plus one hour.
- Step 2 Transfer the test item to another chamber (previously adjusted to the upper specified temperature) as quickly as possible such that condensation or fogging occurs. The use of insulated transport containers is recommended. Maintain this second chamber at the specified upper temperature (usually room ambient) with a relative humidity of 95 ± 5 percent.
- Step 3 Start operation and any performance tests of the test item 60 ± 15 seconds after completion of the transfer, and document results. If the test item fails to operate as intended, follow the guidance in paragraph 4.3.2 for test item failure.
- Step 4 Return the test item to the low temperature chamber and repeat Steps 1-3 as required to complete the number of cycles identified in paragraph 2.3.4.
- Step 5 Return the test item to standard ambient conditions. Perform a complete visual and operational check, and document the results. See paragraph 5 for analysis of results.

4.4.4 Procedure III – Rapid Temperature Change.

- Step 1 Adjust the chamber temperature to the specified upper temperature (usually standard ambient) at a rate of approximately 3 °C (5 °F) per minute, and a relative humidity of 95 ± 5 percent. Maintain these conditions until the test item temperature has stabilized plus one hour.
- Step 2 Transfer the test item as quickly as possible and in not more than 5 minutes to another chamber stabilized at -10 °C (14 °F). Stabilize the test item temperature and hold for one additional hour.
- Step 3 Unless otherwise specified, perform an operational check. If the test item fails to operate as intended, follow the guidance in paragraph 4.3.2 for test item failure.

MIL-STD-810H
METHOD 524.1

Step 4 Transfer the test item as quickly as possible and in not more than 5 minutes to another chamber stabilized at the specified upper temperature (usually standard ambient) and a relative humidity of 95 ± 5 percent. Note the presence of any free water, and repeat Step 2 through 4 for a total of three cycles unless otherwise specified.

Step 5 Return the test item to standard ambient conditions. Perform an operational check and physical inspection, and document results. If the test item fails to operate as intended, see paragraph 5 for analysis of results, and follow the guidance in paragraph 4.3.2 for test item failure.

5. ANALYSIS OF RESULTS.

In addition to the guidance provided in Part One, paragraph 5.14, the following information is provided to assist in the evaluation of the test results. Apply any data relative to failure of a test item to meet the requirements of the materiel specifications to the test analysis, and consider related information such as:

- a. Results of nondestructive examinations (if any) of materiel following the freeze-thaw test(s) may be conducted at the extreme temperatures.
- b. Degradation or changes in operating characteristics allowed at the temperature extremes.
- c. Evidence of improper lubrication and assurance that the lubricants specified for the environmental condition were used.

6. REFERENCE/RELATED DOCUMENTS.

6.1 Referenced Documents.

- a. Allied Environmental Conditions and Test Publication (AECTP) 300, "Climatic Environmental Tests" (under STANAG 4370), Method 315.
- b. NATO STANAG 4370, Environmental Testing.
- c. Environmental Standards for Materiel Design Group of the AirLand Battlefield Environment Executive (ALBE) Committee (1987), "Environmental Factors and Standards for Atmospheric Obscurants, Climate, and Terrain", Washington, D.C.

6.2 Related Documents.

- a. AR 70-38, Research, Development, Test and Evaluation of Materiel for Extreme Climatic Conditions.
- b. MIL-HDBK-310, Global Climatic Data for Developing Military Products.
- c. Synopsis of Background Material for MIL-STD-210B, Climatic Extremes for Military Equipment. Bedford, MA: Air Force Cambridge Research Laboratories, 24 January 1974. DTIC number AD-780-508.
- d. NATO Allied Environmental Conditions and Test Publication (AECTP) 230, "Climatic Conditions".
- e. Egbert, Herbert W. "The History and Rationale of MIL-STD-810 (Edition 2)", January 2010; Institute of Environmental Sciences and Technology, Arlington Place One, 2340 S. Arlington Heights Road, Suite 100, Arlington Heights, IL 60005-4516.

(Copies of Department of Defense Specifications, Standards, and Handbooks, and International Standardization Agreements are available online at <https://assist.dla.mil>.)

Requests for other defense-related technical publications may be directed to the Defense Technical Information Center (DTIC), ATTN: DTIC-BR, Suite 0944, 8725 John J. Kingman Road, Fort Belvoir VA 22060-6218, 1-800-225-3842 (Assistance--selection 3, option 2), <http://www.dtic.mil/dtic/>; and the National Technical Information Service (NTIS), Springfield VA 22161, 1-800-553-NTIS (6847), <http://www.ntis.gov/>.

MIL-STD-810H
METHOD 525.2**METHOD 525.2**
TIME WAVEFORM REPLICATION**CONTENTS**

<u>Paragraph</u>	<u>Page</u>
1. SCOPE	1
1.1 PURPOSE	1
1.2 APPLICATION	1
1.2.1 TIME WAVEFORM REPLICATION	1
1.2.2 SESA TIME WAVEFORM REPLICATION.....	2
1.2.3 TIME TRACE.....	2
1.2.4 GENERAL CONSIDERATIONS AND TERMINOLOGY	2
1.2.5 TIME-VARYING TIME TRACE-PHYSICAL PHENOMENON	3
1.2.6 GENERAL TWR TEST PHILOSOPHY WITH REGARD TO TIME TRACE SIMULATION (AND SCALING).....	5
1.3 LIMITATIONS.....	7
2. TAILORING GUIDANCE.....	8
2.1 SELECTING THE TWR METHOD	8
2.1.1 EFFECTS OF TRANSITION TO TIME TRACE TWR.....	8
2.1.2 SEQUENCE AMONG OTHER METHODS.....	8
2.2 SELECTING A PROCEDURE.....	8
2.3 DETERMINE OF TEST LEVELS AND CONDITIONS.....	8
2.3.1 GENERAL CONSIDERATIONS	9
2.4 TEST ITEM OPERATION	9
3. INFORMATION REQUIRED.....	10
3.1 PRETEST.....	10
3.2 DURING TEST.....	10
3.3 POST-TEST	10
4. TEST PROCESS	11
4.1 TEST FACILITY	11
4.1.1 PROCEDURE I-THE SESA REPLICATION OF A FIELD MEASURED MATERIEL TIME TRACE INPUT/RESPONSE.....	11
4.1.2 PROCEDURE II-THE SESA REPLICATION OF AN ANALYTICALLY SPECIFIED MATERIEL TIME TRACE INPUT/RESPONSE.....	11
4.2 CONTROLS	11
4.2.1 CALIBRATION.....	11
4.2.2 TOLERANCES.....	11
4.3 TEST INTERRUPTION	14
4.3.1 INTERRUPTION DUE TO LABORATORY EQUIPMENT MALFUNCTION.....	14
4.3.2 INTERRUPTION DUE TO TEST MATERIEL OPERATION FAILURE	14
4.3.3 INTERRUPTION DUE TO A SCHEDULED EVENT	15
4.3.4 INTERRUPTION DUE TO EXCEEDING TEST TOLERANCES.....	15
4.4 INSTRUMENTATION	15
4.5 TEST EXECUTION	16
4.5.1 PREPARATION FOR TEST.....	16
4.5.1.1 PRELIMINARY STEPS	16
4.5.1.2 PRETEST CHECKOUT	17

MIL-STD-810H
METHOD 525.2

CONTENTS - Continued

<u>Paragraph</u>	<u>Page</u>
4.5.2	PROCEDURE SPECIFIC..... 17
4.5.2.1	PROCEDURE I-SESA REPLICATION OF A FIELD MEASURED MATERIEL TIME TRACE INPUT/RESPONSE..... 17
4.5.2.2	PROCEDURE II-SESA REPLICATION OF AN ANALYTICALLY SPECIFIED MATERIEL TIME TRACE INPUT/RESPONSE..... 18
4.5.3	DATA ANALYSIS 18
5.	ANALYSIS OF RESULTS 18
5.1	PHYSICS OF FAILURE..... 18
5.2	QUALIFICATION TESTS..... 18
5.3	OTHER TESTS..... 19
6.	REFERENCE/RELATED DOCUMENTS 19
6.1	REFERENCED DOCUMENTS..... 19
6.2	RELATED DOCUMENTS..... 19

FIGURES

FIGURE 525.2-1.	BASIC TWR TEST MODES AS RELATED TO TIME TRACE SCALING 4
FIGURE 525.2-2.	BASIC TWR TEST SIMULATION COMBINATIONS..... 6

METHOD 525.2, ANNEX A
SESA POST-TEST ANALYSIS ILLUSTRATION FOR TEST TOLERANCE ASSESSMENT

1.	PURPOSEA-1
2.	GENERAL PHILOSOPHY FOR TWR TESTINGA-1
3.	DESCRIPTION OF REFERENCE TIME TRACE.....A-1
4.	TIME TRACE PRE-PROCESSINGA-2
4.1	INTRODUCTIONA-2
4.2	FREQUENCY BAND LIMITINGA-4
4.3	TIME TRACE CORRELATIONA-5
4.4	TIME TRACE SEGMENT IDENTIFICATIONA-6
5.	POST-TEST PROCESSING FOR TPPA-9
6.	TPP TRANSIENT VIBRATIONA-10
7.	TPP STATIONARY VIBRATION.....A-13
8.	TPP SHOCK.....A-18
9.	POST-TEST PROCESSING FOR STAA-22

MIL-STD-810H
METHOD 525.2

CONTENTS - Continued

<u>Paragraph</u>	<u>Page</u>
ANNEX A FIGURES	
FIGURE 525.2A-1. FIELD MEASURED ACCELERATION REFERENCE TIME TRACE.....	A-2
FIGURE 525.2A-2A. EXCITER HEAD (H) (REFERENCE/CONTROL TIME TRACES PRIOR TO POST-TEST PREPROCESSING)	A-3
FIGURE 525.2A-2B. EXCITER SLIP TABLE (S) (REFERENCE/CONTROL TIME TRACES PRIOR TO POST-TEST PREPROCESSING).....	A-3
FIGURE 525.2A-3. REFERENCE/CONTROL TIME TRACE PERIODOGRAMS FOR FREQUENCY BAND-LIMITING THROUGH FFT WINDOW FILTERING	A-5
FIGURE 525.2A-4. CROSS-COVARIANCE FUNCTION ESTIMATES BETWEEN REFERENCE AND CONTROL TIME TRACES	A-6
FIGURE 525.2A-5. TIME TRACE SEGMENT IDENTIFICATION FROM PREVIOUSLY TRUNCATED REFERENCE TIME TRACES	A-7
FIGURE 525.2A-6. TRANSIENT VIBRATION REFERENCE TIME TRACE SEGMENT.....	A-7
FIGURE 525.2A-7. STATIONARY RANDOM VIBRATION REFERENCE TIME TRACE SEGMENT.....	A-8
FIGURE 525.2A-8. SHOCK REFERENCE TIME TRACE SEGMENT	A-8
FIGURE 525.2A-9. PLOTS OF OVERALL DIFFERENCE TIME TRACE WITH ROOT-MEAN-SQUARE.....	A-9
FIGURE 525.2A-9A. DIFFERENCE EXCITER (H)	A-9
FIGURE 525.2A-9B. DIFFERENCE EXCITER (S).....	A-9
FIGURE 525.2A-9C. TIME TRACE OF DIFFERENCE OF THE DIFFERENCES ((S) - (H)).....	A-9
FIGURE 525.2A-10. TRANSIENT VIBRATION TIME TRACES - R, C, AND S	A-10
FIGURE 525.2A-11. R VERSUS C CROSS-PLOT	A-11
FIGURE 525.2A-12. TRANSIENT VIBRATION Q-Q PLOT FOR S VERSUS GAUSSIAN	A-11
FIGURE 525.2A-13. COMPOSITE ROOT-MEAN-SQUARE ENVELOPE ESTIMATES FOR R AND C	A-12
FIGURE 525.2A-14. COMPOSITE NORMALIZED ASD ESTIMATES FOR R AND C	A-12
FIGURE 525.2A-15. STATIONARY VIBRATION TIME TRACES - R, C, AND S	A-13
FIGURE 525.2A-16. STATIONARY VIBRATION PROBABILITY DENSITY FUNCTION ESTIMATES	A-14
FIGURE 525.2A-17. STATIONARY VIBRATION Q-Q PLOT FOR S VERSUS GAUSSIAN	A-14
FIGURE 525.2A-18A. FOT ERROR ASSESSMENT - 10% REA ERROR FRACTION-OF-TIME (FOT)	A-15
FIGURE 525.2A-18B. FOT ERROR ASSESSMENT - 5% REA FOT ERROR BOUNDS.....	A-16
FIGURE 525.2A-18C. FOT ERROR ASSESSMENT - ONE SIDED 10% REA FOT ERROR BOUNDS	A-16
FIGURE 525.2A-19A. COMPOSITE ASD ESTIMATES FOR R AND C.....	A-17
FIGURE 525.2A-19B. ASD ESTIMATE FOR S.....	A-17
FIGURE 525.2A-20. SHOCK TIME TRACES - R, C, AND S	A-18
FIGURE 525.2A-21. R VERSUS C CROSS-PLOT	A-19
FIGURE 525.2A-22. SHOCK Q-Q PLOT FOR S VERSUS GAUSSIAN	A-19
FIGURE 525.2A-23A. COMPOSITE PSEUDO-VELOCITY MAXIMAX PSEUDO-VELOCITY SRS FOR R AND C	A-20
FIGURE 525.2A-23B. COMPOSITE PSEUDO-VELOCITY MAXIMAX ACCELERATION SRS FOR R AND C.....	A-20
FIGURE 525.2A-24. ESD ESTIMATES FOR R AND C	A-21
FIGURE 525.2A-25. ESD ESTIMATE FOR S.....	A-21
FIGURE 525.2A-26. SHORT-TIME AVERAGING FOR DIFFERENCE MEAN.....	A-22
FIGURE 525.2A-27. SHORT-TIME AVERAGING FOR DIFFERENCE ROOT-MEAN-SQUARE.....	A-23

METHOD 525.2, ANNEX B

**SUMMARY OF POST-TEST ANALYSIS PROCESSING PROCEDURES AND TEST TOLERANCE
SPECIFICATION**

1. INTRODUCTION.....	B-1
2. TERMINOLOGY.....	B-1
3. REPLICATION ERROR (TEST TOLERANCE) ASSESSMENT EXPRESSIONS.....	B-2
4. REPLICATION ERROR TOLERANCE SPECIFICATION.....	B-9

MIL-STD-810H
METHOD 525.2

CONTENTS - Continued

<u>Paragraph</u>	<u>Page</u>
ANNEX B TABLE	
TABLE 525.2B-I. SUMMARY OF ERROR ASSESSMENT EXPRESSIONS	B-3

MIL-STD-810H
METHOD 525.2

METHOD 525.2

TIME WAVEFORM REPLICATION

NOTE: Tailoring is required. Select methods, procedures, and parameter levels based on the tailoring process described in Part One, paragraph 4.2.2, and Annex C. Apply the general guidelines for laboratory test methods described in Part One, paragraph 5 of this Standard.

1. SCOPE.

1.1 Purpose.

Replication of a time trace under Time Waveform Replication (TWR) methodology in the laboratory is performed to:

- a. Provide a degree of confidence that the materiel can structurally and functionally withstand the measured or analytically specified test time trace(s) to which the materiel is likely to be exposed in the operational field environment.
- b. Experimentally estimate the materiel's fragility level in relation to form, level, duration, or repeated application of the test time trace(s).

1.2 Application.

1.2.1 Time Waveform Replication.

This test Method discusses TWR from a single-exciter/single-axis (SESA) perspective. Multiple-exciter TWR applications are addressed in Method 527.2. This Method provides guidelines for developing test tolerance criteria for single axis TWR testing. Annex A addresses SESA TWR testing by illustration. Annex B provides an overview of post-test analysis tools useful in TWR for verification of test tolerance compliance.

1.2.2 SESA Time Waveform Replication.

SESA TWR consists of the replication of either measured or analytically specified time trace(s) in the laboratory with a single exciter in a single axis, and is performed to accurately preserve the spectral and temporal characteristics of the measured environment. Without loss of generality in the discussion to follow, application of this Method will consist of a single time trace. SESA TWR in this Method is founded upon a "Deterministic/Probabilistic" framework of random process theory. An analytically specified time trace is assumed to be fully deterministic in nature with no relationship to a probabilistic framework, e.g., a chance of occurrence. A single measured time trace within a probabilistic framework is assumed to be a sample realization from an ensemble of possible time traces generated by an experiment that is replicated a number of times under identical conditions. For a single measured time trace, it is optimal to assume that the measured time trace represents the random process ensemble mean determined by averaging over an ensemble of records at each time increment, and has a confidence coefficient of 0.50. For more than one measured time trace captured under identical experimental conditions, it may be possible to create a time trace ensemble for which averaging over the ensemble members for each sample time increment yields valid estimates of the statistical moments for the unknown stochastic process underlying the time trace generation. This general deterministic/probabilistic philosophy for SESA TWR has important implications for time trace scaling considerations. Replicating a single time trace in this Method is generally transparent to the distinction between a deterministic time trace and the ensemble mean of a stochastic time trace.

Until recently, the replication of time traces representing measured samples of field environments varying in time and even frequency, or a combination of both time/frequency variations, was not possible using commonly available exciter control system software. The advent of more powerful data processing hardware/software, and the implementation of advanced control strategies, has led to exciter control system hardware and software that permit convenient replication of extended time-varying test environments on a single exciter in a single axis in the laboratory. TWR test methodology strongly reflects the concept of "test tailoring".

MIL-STD-810H
METHOD 525.2

1.2.3 Time Trace.

The general term “time trace” is employed throughout this Method in an attempt to capture all of the possibilities of TWR applied in the replication of field measured (stochastic) or analytically specified (deterministic) environments in the laboratory. The following six forms of time trace are potential candidates for TWR testing.

- a. Stationary random Gaussian time trace with arbitrary ASD of arbitrary duration.
- b. Stationary random non-Gaussian time trace (for certain forms of non-Gaussian distribution, e.g., local skewness and high kurtosis) with specified ASD of arbitrary duration.
- c. Short duration shock time trace.
- d. Non-stationary time trace that has time-varying amplitude, time-varying frequency or both of an intermediate duration (longer than a typical shock time trace).
- e. Non-stationary/stationary time trace that is repetitive at fixed period (e.g., gunfire shock).
- f. Non-linear form time trace.

For general application, the time trace to be replicated under TWR is of a substantially shorter duration than typical stationary random environments, and usually of a longer duration than mechanical shocks. A TWR time trace may be composed of any combination of form specified in 1.2.3a through f above.

1.2.4 General Considerations and Terminology.

For purposes of discussion to follow, a single measured time trace is a function of finite duration having a uniform time sample increment and varying amplitude that is provided in digital form. For convenience, the single time trace under consideration is taken as acceleration, but the principles below apply equally well to other time trace representations such as velocity, displacement, force, etc.

It is assumed that for any measured physical phenomenon, the measurement can be repeated an indefinite number of times under the exact same conditions limited only by measurement resources, i.e., the underlying random process has an ensemble representation generally unknown. In the discussion to follow, reference to a measured time trace ensemble related to an underlying random process will assume the following:

- a. Measured time traces are from a single physical phenomenon and have a joint correlation structure. This basically assumes a uniform and identical sample rate for all time traces, and common beginning and ending points.
- b. The underlying random process has a deterministic component (or “signal”) that can be estimated by the time-varying mean of the ensemble.
- c. The underlying random process has a random component (or “noise”) that can be estimated by a time-varying standard deviation of the ensemble.
- d. If the measured time trace ensemble has only one member then this member will assume to be the underlying random process deterministic component or mean with a confidence coefficient of 0.5, i.e., this sample time trace has a 0.5 probability of being greater or less than the true underlying random process mean at each time increment.

NOTE: This is not strictly correct because time traces have serial correlation information that essentially correlates the time trace from one time increment to the next time increment and, thus, the confidence coefficient may vary depending upon the degree of serial correlation.

Figure 525.2-1 provides a schematic outlining three basic TWR test modes designed to clarify the issue of time trace scaling. **Generally, Method 525.2 attempts to define time trace scaling, but provides no direct guidance on time trace scaling; relegating the rationale for any time trace scaling to procedures outside this Method.** The first TWR test mode involves a single measured time trace (or concatenation of N measured time traces) replicated under TWR with no scaling and no basis for scaling (termed NS for No-Scaling). In this mode there is no explicit ensemble basis

MIL-STD-810H
METHOD 525.2

for an underlying random process, and the time trace for replication is assumed to have a confidence coefficient of 0.50. A second mode for testing involves an ensemble of N measured time traces from a single phenomenon representative of sample functions from an underlying random process. In this second mode, any basis for scaling must be obtained from the N member ensemble, external to this Method, and will generally involve separate scale factors for the deterministic and random component estimates defined by the ensemble (termed **ES** for possibility of Ensemble-Scaling). A third mode involves an analytically specified time trace that assumes a basis for amplitude scaling (for a single time trace or an ensemble), and is termed **AS** for Analytical-Scaling. In this third mode the basis for scaling must come from outside this Method, and is generally “ad hoc” as will be defined in paragraph 1.2.6. A fourth mode of scaling with the intent of adding conservatism is possible through the introduction of increased test duration, and is termed as **TS** for Time-Scaling. In summary, (1) **NS** is the recommended fully tailored TWR testing that this Method is designed to address with no scaling allowed; (2) **ES** implies a proper mode of scaling based upon adequate ensemble sample trace information and rationale outside this Method, and (3) **AS** implies TWR testing using scaling based upon methodology outside this Method, but is not generally recommended unless the methodology has been properly validated. (4) **TS** implies conservatism in terms of test durations exceeding the basic mission scenario.

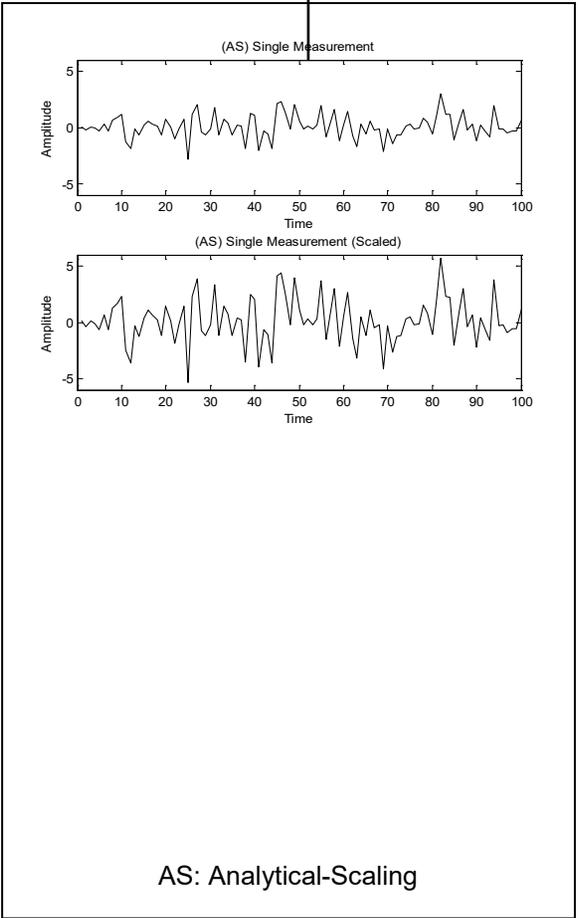
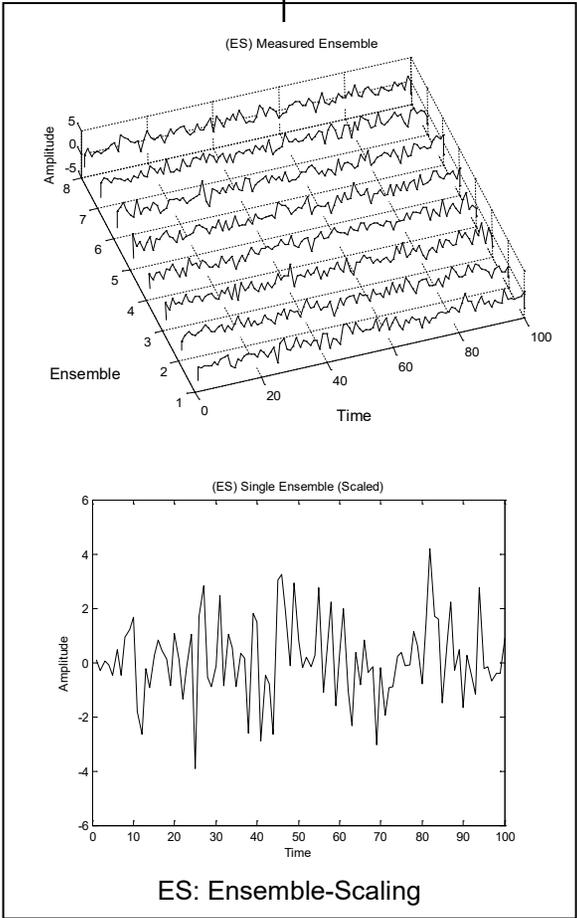
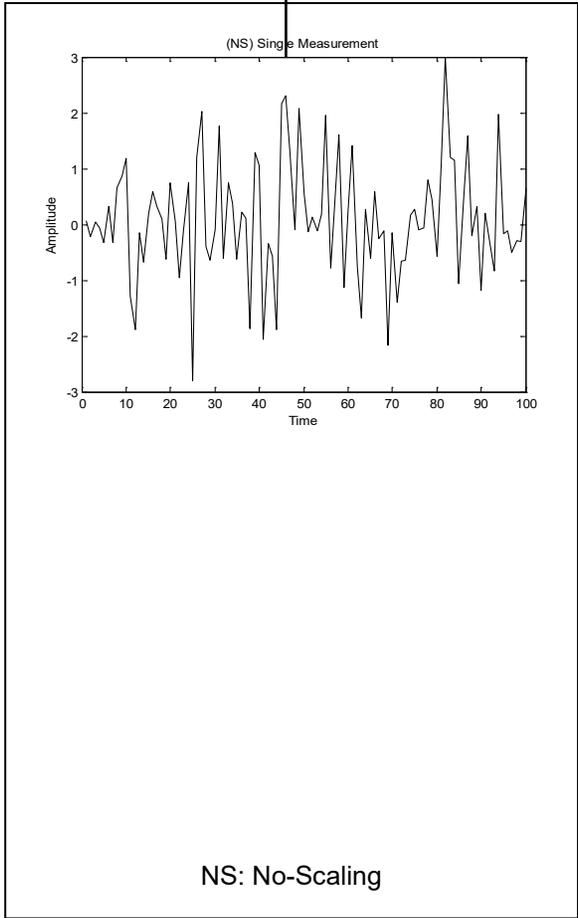
Scaling based upon other than measured ensemble statistics is termed *ad hoc* in this Method. As implied above, the creation of an ensemble implies that there exists an ensemble mean (deterministic component) estimate for the underlying random process, and a “residual ensemble” created by subtracting the mean from each member of the ensemble (random component) for the underlying random process. The deterministic component is “orthogonal” or uncorrelated to the random component by definition. Scaling for a measured ensemble based random process must consider individual scaling of both the deterministic and random components. Scaling based upon extraction of parameters from individual time traces, assessing these parameters, and scaling time traces based upon this parameter assessment in general is ad hoc. It is termed “ad hoc” because it scales the deterministic component and the random component essentially the same. For such ensemble representation, the deterministic component (the signal) and the random component (the noise) need to be scaled separately.

Underlying random processes within this Method will be assumed to have sampled continuous time traces e.g., analog voltage signal, in contrast to discrete processes such as a Poisson counting process trace. However, a laboratory test scenario may incorporate a discrete underlying random process through application of a series of concatenated time traces under TWR. Such an extended laboratory test scenario may provide more overall information for materiel structural and functional integrity assessment. Extended laboratory test scenarios will be discussed further when test axes, duration, and the number of time trace(s) applications are discussed in paragraph 2.3 below. It would also appear that TWR is capable of replication of time traces that are generated as result of reducing a uniformly sampled time trace for fatigue purposes. Typically, traces suitable for fatigue testing only consist of discrete peak and valley points, and are the result of applying a cycle counting process to a uniformly sampled time trace. Cycle counting and peak/valley identification generally distort the measured time trace in time, and can be characterized as a form of nonlinear time trace that can be forced to be band-limited within the exciter bandwidth through appropriate interpolation.

1.2.5 Time-Varying Time Trace - Physical Phenomenon.

A time-varying trace captured in measurement signals is caused by the time-varying phenomenon that is being measured. In general, the time-varying characteristics of the environment (excluding shock) are longer than the lowest resonant frequency characteristics of the materiel under test. In particular, a time-varying trace may range from three seconds to several hundred seconds.

TWR Test Scaling



525.2-4

MIL-STD-810H
METHOD 525.2

Figure 525.2-1. Basic TWR test modes as related to time trace scaling.

MIL-STD-810H
METHOD 525.2

1.2.6 General TWR Test Philosophy With Regard To Time Trace Simulation (and Scaling).

As emphasized in paragraph 1.2.4, time trace scaling to enhance conservativeness of laboratory testing is generally outside the scope of this Method. Figure 525.2-2 defines simulation possibilities within TWR including time trace scale rationale assumed to be provided external to this Method.

Two terms important to understanding TWR simulation will be introduced. The first term, *intrinsic statistics*, refers to the time-varying statistical estimates available from a single measured time trace (generally from short-time estimates). A single time trace has a confidence coefficient of 0.50, and the time-varying statistical estimates provide no information relative to the underlying ensemble-based random process, except for an estimate of the mean of the underlying random process. The second term, *extrinsic statistics*, refers to the time-varying statistical estimates available from more than one measured time trace, which forms a sample time trace ensemble. In this case, not only is an estimate of the underlying random process mean available, but also an estimate of its variance on a time increment basis. For comprehensive LCEP directed TWR materiel testing specifying analytical time traces through simulation, knowledge of the extrinsic statistics is essential. In general, specifying analytical time traces through simulation based upon intrinsic statistics is very limited, and usually unreliable for testing to the underlying random process (Method 519.8, Annex B discusses this further). Conversely, if a very small measured time trace sample ensemble is available, estimates of the underlying random process parameters tend to have large errors providing for an unreliable simulation. In this latter case, a more optimum test scenario is provided by replication of each of the individual measured time traces in a pre-defined sequence. A useful way to view intrinsic versus extrinsic statistics is to envision a One-Way Analysis of Variance, whereby the intrinsic statistics correspond to the “error within”, and the extrinsic statistics correspond to the “error among”.

Figure 525.2-2 attempts to clarify simulation issues for the four potential TWR test modes provided in the Figure. Whenever simulation is undertaken, it is implicit that the measured time trace(s) is scaled as a result of the simulation. This scaling is not considered “ad hoc” per se. The left most portion of the figure provides the simplest TWR test scenario with a single measured time trace and no scaling NS and no simulation (termed SM for Single-Measured). The left center portion of the figure provides for a single measured time trace with intrinsic trace time-average estimation used for creation of a simulated ensemble consisting of a single time trace, where AS is implied (termed SS for Single-Simulated). The right center portion provides the case of multiple measurements from a single phenomenon, with ensemble creation followed by simulation based upon combined intrinsic/extrinsic statistics and ES implied (termed MS for Multiple-Scaled). The right-most portion of the figure provides the case of multiple measurements from a single phenomenon, and the possibility of concatenation of the measurements (assuming ensemble information for simulation is too limited) (termed MM for Multiple-Measured). For generality, MM may allow for (but does not recommend) the use of “ad hoc” scaling of the individual measurements to be concatenated. To summarize, (1) SM is the recommended basic fully tailored TWR testing that this Method is designed to address; (2) SS is a less desired approach to replication of details of a single time trace with a minimal set of information that implies scaling a single time trace; (3) MS is recommended as a specialized information/labor intensive, but faithful approach to replication of an underlying random process under TWR and, finally, (4) MM is recommended for a time trace concatenation form of testing where “ad hoc” scaling procedures are best not applied.

It is vitally important that the distinctions made in Figure 525.2-1 and Figure 525.2-2 be recognized in TWR testing. In addition it is important to note the following:

- a. For zero mean Gaussian distributed stationary time traces, scaling is upon the random component alone, and ways of performing scaling for more than one time trace are provided in Method 519.8, Annex A. For these time traces, the statistics in the frequency domain, i.e., autospectral density estimates, are computed and envelopes determined.
- b. For time traces with a time-varying mean-square, it is unlikely that the ensemble representation of the underlying random process will have a time invariant or constant variance. If the underlying random process has a time-varying variance, then the sample time traces cannot be scaled by a constant and still preserve the probabilistic structure of the process.

Test
TWR Simulation / Scaling

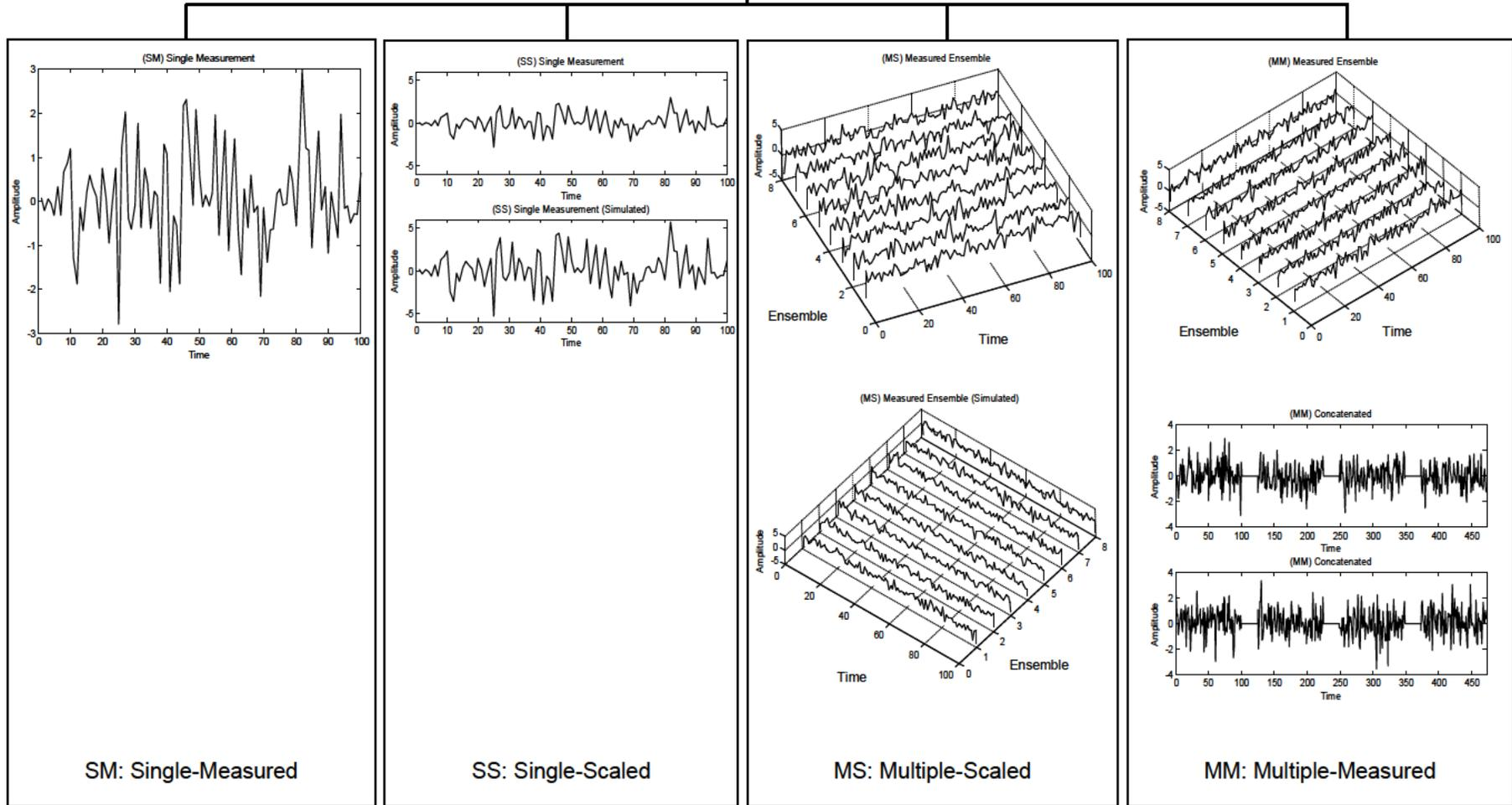


Figure 525.2-2. Basic TWR test simulation combinations.

MIL-STD-810H
METHOD 525.2

- c. For multiple time traces from the same underlying random process, creation of an ensemble may not be straight forward since it is nearly impossible to obtain measured time traces with exactly the same length by repeating the experiment, i.e., collection process (see paragraph 6.1, reference c.). It is also important to remember that the measured time traces must be “registered” or “serially correlated” according to some physical phenomenon, so that averaging over the ensemble members for each sample time point is meaningful. In the case where a *valid ensemble* is available, it is possible to estimate both the mean and variance of the random process at each time increment by averaging over the ensemble members. Under these circumstances, TWR testing could proceed on the basis of use of (a) the ensemble mean, (b) the “maximum” of the ensemble members, (c) all N ensemble members, or (d) the ensemble mean plus (minus) a proportion of the square root of the ensemble variance. All four of these choices will preserve the probability structure of the unknown random process underlying the ensemble realizations. It is vitally important to note that “scaling” the ensemble mean, or any ensemble member by a constant factor, in general, will not provide time traces that are representative of the probability structure of the random process, unless the variance of the unknown random process is constant in time. Use of (d) above for TWR testing needs further amplification. The variance estimate obtained from averaging over the ensemble at each time increment will provide an unbiased estimate of the variance at the time increment with substantial random error or variation. Scaling each time point by the square root of the variance (with appropriate sign) provides for a “non-linear” transformation of the scaled time trace (since adjacent time increments may be scaled by factors that are different by an order of magnitude). Thus it becomes necessary to smooth the ensemble variance estimate in time to obtain acceptable time-varying scale factors. This smoothing introduces bias error with the benefit of decreased random error or variability. Unfortunately, there is little concrete guidance on the degree of smoothing that should be applied and, in fact, this becomes a form of a non-linear regression problem (i.e., smoothing is dependent upon the true unknown shape of the data being smoothed). Scaling based upon statistical ensemble estimates should only be performed by a competent data analyst familiar with random process theory, and the techniques of non-linear regression.

This summarizes the rationale behind the philosophy of this Method of simulation, and not directly recommending the “scaling” of measured time traces. Method 519.8, Gunfire Shock, Annex B, discusses extensively scaling for measured gunfire time traces.

In TWR testing involving analytically-specified deterministic time trace information, there is substantial test flexibility depending upon the assumptions that are made, be they ad hoc or from some rational basis. In this case, this Method becomes merely a tool for replicating what is generated without regard for the assumptions behind the specification. Any rationale for scaling is again external to this Method.

1.3 Limitations.

This Method addresses very general time-varying traces not necessarily identifiable with underlying stationary or non-stationary random processes. It is apparent from various vendor TWR hardware/software configurations that the only requirement for application of this Method is the band-limited character of the time trace for replication, and its compatibility with the band-limited characteristics of the device (exciter) to be driven with the TWR hardware/software. For example, measured time traces that vary in frequency can be replicated as long as the time trace bandwidth is limited to overall bandwidth of the exciter control system. Non-Gaussian time traces can be replicated under TWR. All measured time traces can be replicated under TWR, provided they are within the band limit capabilities of the exciter control system to which they are applied for testing purposes. Limitations of this Method include the following:

- a. Does not address very long (several hour) time traces that can be termed “stationary” in nature (Gaussian or non-Gaussian and possibly have significant discrete components e.g., UAV measured environments). It is possible to repeat a given time trace multiple times, however, variations associated with actual experiment repetitions in the field will not be captured. It is important to note that, given a single stationary Gaussian or non-Gaussian time trace of sufficient length, it is possible to (1) divide this time trace into multiple time trace segments at zero crossings (required close to zero mean for each segment) and, (2) randomly place these segments into a permuted order to generate multiple time traces of sufficient length but essentially “stochastically independent” of one another. This can be particularly attractive for measured stationary non-Gaussian environments where the non-Gaussian “exact moment structure” must be preserved over long periods of time. The alternative to this is precise modeling of the measurement time trace and subsequent stochastic generation of unlimited segments for TWR input.

MIL-STD-810H
METHOD 525.2

- b. Does not address the advantages and disadvantages of replicating very short duration time traces (shocks) over and above application of Method 516.8.
- c. Does not explicitly address time traces that have highly variable frequency characteristics in time.
- d. Does not explicitly address time traces that are nonlinear in nature.
- e. Does not explicitly address repeated environments that may be of a non-stationary nature because of the occurrence pattern of the environment. For example, no discussion is provided on occurrence statistics that may be modeled in terms of a non-stationary (rate-varying) Poisson process.
- f. Generally does not address the characteristics of the time trace on the materiel in terms of materiel “rise-time” response.

2. TAILORING GUIDANCE.

2.1 Selecting the TWR Method.

After examining requirements documents and applying the tailoring process in Part One of this Standard to determine where significant time-varying effects are foreseen in the life cycle of the materiel, use the following to confirm the need for this Method and to place it in sequence with other methods.

2.1.1 Effects of Transition To Time Trace TWR.

Method 525.2 is broadly consistent with the philosophy of test tailoring. A substantial high amplitude field measured time trace has the potential for producing adverse effects on all electronic materiel. The potential for adverse effects may be related to transition time and duration of the time trace. When transition to the time trace and time variation characteristics in the time trace is short, “rise times” in materiel response may be adequate to cause degradation in performance. When duration of the time trace is substantial in comparison to the transition times, the effects to materiel, e.g., low cycle fatigue, may also be substantial. In performing a TWR test, it is desirable that the onset/termination of the significant environment be consistent with the onset/termination of the environment anticipated in the field.

2.1.2 Sequence Among Other Methods.

- a. General. Use the anticipated life cycle sequence of events as a general sequence guide (see Part One, paragraph 5.5).
- b. Unique to this Method. Generally, significant time-varying traces may occur at any time during the life cycle of the materiel, and are usually interspersed among stationary random and shock environments that are covered under guidance provided in Methods 514.8 and 516.8, respectively.

2.2 Selecting a Procedure.

This Method includes two basic test procedures:

- a. Procedure I: The SESA replication of a field measured materiel time trace input/response.
- b. Procedure II: The SESA replication of an analytically specified materiel time trace input/response.

Based on the test data requirements, determine which test procedure is applicable. In particular, determine if there exists a carefully measured and properly processed field measured time trace, or if there is a generated, uniformly sampled band-limited analytical time trace. Determine if the time trace can be placed in an ASCII data file for archive and replication. If there are field measured or analytically specified environmental time traces for a materiel component, determine if the time trace(s) has an extended form over the entire materiel, i.e., determine the extent of spatial correlation.

2.3 Determine Test Levels and Conditions.

For TWR replication of measured time traces in the laboratory, the test levels are fully specified by the field measured time traces. If several field measured time traces are available, generally, the tester will want to make up a single ASCII file consisting of several “events” appropriately spaced in time. In general, for this Method, Procedure I, it is not recommended that any factor, constant or otherwise, be applied to “enhance” the measured time trace for testing (for reasons discussed in paragraph 1.2.6). For this Method, Procedure II, any scaling must be consistent with information in paragraph 1.2.6 and, generally, the scaling must not be ad hoc in nature. It is not recommended that

MIL-STD-810H
METHOD 525.2

time traces that exceed the capacity of the vibration exciter be scaled down by gain, e.g., run at -3 dB. For pretest exciter control system compensation, i.e., establishing the exciter system transfer function, the time trace may be applied at lower levels to either the test item or to a dynamically similar surrogate. Identify the test conditions, particularly with respect to temperature. Exercise extreme care in consideration of the details in the tailoring process. Base the test level and condition selections on the requirements documents, the Life Cycle Environmental Profile, and information provided within this procedure.

2.3.1 General Considerations.

As has been mentioned in paragraph 1.2, statistical estimates defining the behavior of a non-stationary random process can only be made on ensembles of time traces from the non-stationary process. Typically, only one sample time trace from an ensemble of an unknown non-stationary random process is available. It is absolutely essential that the test time trace be fully documented such that transfer of an ASCII file of the test time trace can be made to other laboratories for application or testing, and be repeated in the future. Information on the location of measurement transducers and general test configuration must accompany the test time trace. Any such analytical description can be tied directly to comparison between the time trace input to the exciter control system (reference time trace) and the test output as recorded by the exciter control system (control time trace). To clarify the terminology standard, the "reference time trace" is merely the ASCII representation of the time trace for the laboratory test. The "control time trace" is the ASCII digital file created by the exciter control system representing the "result" of the test. This control time trace is created by converting an analog voltage signal from a measurement device, e.g., an accelerometer mounted on the test item or test item interface at the location that the reference time trace is to be replicated, to a digital form by a signal conditioned analog-to-digital device. It is referred to as a "control" time trace because it is in the comparison of the reference time trace to the control time trace that the analog input to the exciter device is compensated in order to reproduce the reference time trace. The "control" time trace represents the "best fit" of the output of the exciter control system parameters through compensation to the desired input reference time trace. Annex A provides the details of a typical time reference/control comparison. A successful test under TWR is defined as a test, whereby the control time trace compares to the reference time trace within the tolerance limits specified for the test. The tolerance limits may be specified in the time domain, the frequency domain or a combination of the two. Annex B provides the basis for developing meaningful tolerance limits under SESA TWR. Rudimentary tolerance limits are provided within most vendor supplied TWR software for purposes of "controlling," i.e., appropriately compensating the system prior to test but, in general, the test laboratory will want to establish and implement some well-defined analytical procedures for comparing the control time trace ASCII file with the reference time trace ASCII file. Annexes A and B provide guidance in this area.

The test item may be instrumented at other locations than at the point of "control." The other measurements made during testing are referred to as monitoring measurements. Such measurements may be useful for purposes such as analytical modeling of the materiel, or just monitoring materiel response dynamic characteristics, and will not be discussed further here. For SESA exciter laboratory testing, the TWR software allows only single measurement comparison and monitoring for signal compensation "control" purposes.

For the TWR procedure, subject the test item to a sufficient number of suitable time trace events to meet the specified test conditions. Generally, the number of times the test item is subject to a given time trace event is determined from the materiel's life cycle profile in much the same way the duration for stationary random vibration is determined or the number of shock applications for shock is determined. In any case, subject the test item to no fewer than three time trace events for establishing confidence in the materiel's integrity under test if specific information from the materiel's life cycle profile is not available.

2.4 Test Item Operation.

Whenever practical, ensure the test item is active and operating during TWR testing. Monitor and record achieved performance correlated in time with the test time trace. Obtain as much data as possible that define the sensitivity of the materiel to the time trace environment. Where tests are conducted to determine operational capability while exposed to the environment, operate the test item. In other cases, operate the item where practical. Operation during transportation will not be possible in almost all cases. Also, there are cases where the operational configuration varies with mission phase, or where operation at high time trace levels may not be required, and may be likely to result in damage.

MIL-STD-810H
METHOD 525.2

3. INFORMATION REQUIRED.

3.1 Pretest.

The following information is required to conduct and document TWR tests adequately. Tailor the lists to the specific circumstances, adding or deleting items as necessary.

- a. General. Information listed in Part One, paragraphs 5.7 and 5.9; and Part One, Annex A, Task 405 of this Standard.
- b. Specific to this Method.
 - (1) Test system (test item/platform configuration) detailed information including:
 - (a) Control sensor location for control time trace (for single axis testing this will be a point near the original reference measurement point).
 - (b) Reference time trace to be replicated (stored on the TWR control system disk).
 - (c) Monitor sensor locations (if any).
 - (d) Test bandwidth and preprocess reference time trace as required.
 - (e) Levels of pre-test acceptable to obtain appropriate exciter system compensation.
 - (f) Criteria for satisfaction of the test including TWR tolerance limits related to the reference time trace and the control time trace(s).
 - (2) Ability of overall system to replicate the time trace under TWR including band-limited input and the temperature effects (if any). For the application of more than one time trace, the individual time traces must be separated at time intervals that allow the test item to assume a pre-test dynamic condition (unless this is contrary to the requirements of the LCEP). Impedance mismatches and boundary conditions are important for assessing the ability to execute a successful TWR test.
- c. Tailoring. Necessary variations in the basic test procedures to accommodate LCEP requirements and/or facility limitations.

3.2 During Test.

Collect the following information while conducting the test:

- a. General. Information listed in Part One, paragraph 5.10; and in Part One, Annex A, Tasks 405 and 406 of this Standard.
- b. Specific to this Method.
 - (1) Capture of the control time trace in digital form for comparison with the reference time trace.
 - (2) Capture of the monitor time traces in digital form.
 - (3) Recording of the number of individual test events and order for application.
 - (4) Log of auxiliary environmental conditions such as temperature.
 - (5) Log of materiel functional failure.

3.3 Post-Test.

The following post test data shall be included in the test report.

- a. General. Information listed in Part One, paragraph 5.13, and in Annex A; Tasks 405 and 406 of this Standard.
- b. Specific to this Method.
 - (1) Number of exposures of the test item to the time trace(s) and the order if several dissimilar time traces are used in test.
 - (2) Any data measurement anomalies, e.g., high instrumentation noise levels, loss of sensor response.
 - (3) Status of the test item/fixture. In particular, any structural or functional failure of the test item/fixture.

MIL-STD-810H
METHOD 525.2

- (4) Status of measurement system after each test.
- (5) Any variations from the original test plan.

4. TEST PROCESS.

Tailor the following paragraphs, as appropriate for the individual contract or program.

4.1 Test Facility.

Use a test facility, including all auxiliary equipment, capable of executing the TWR test with the control strategies and tolerances discussed in paragraph 4.2. In addition, use measurement transducers, data recording, and data reduction equipment capable of measuring, recording, analyzing and displaying data sufficient to document the test and to acquire any additional data required. In particular, decide on the means of determining if test tolerances have been met through either vendor supplied measures or digital post-processing measures as described in the Annexes. For TWR testing it is important that all measurements and monitoring of test item functioning be correlated in time.

4.1.1 Procedure I - The SESA Replication of a Field Measured Materiel Time Trace Input/Response.

The SESA replication of a field measured time trace representing an input to the materiel or a response of the materiel considers only an un-scaled measured time trace in the laboratory with a single exciter in a single axis or mechanical degree-of-freedom.

4.1.2 Procedure II - The SESA Replication of an Analytically Specified Materiel Time Trace Input/Response.

The SESA replication of an analytically specified time trace representing an input to the materiel or a response of the materiel considers carefully scaled versions of a measured time trace in the laboratory with a single exciter in a single axis or mechanical degree-of-freedom.

4.2 Controls.**4.2.1 Calibration.**

Ensure for the exciter system, all transducers, signal conditioning equipment, independent measurement systems, and the exciter control system hardware are calibrated for conformance with the specified test requirement(s). Ready access to the reference, control, and drive time trace files in ASCII form will be required for independent confirmation of adequacy of the time trace replication for a successful TWR test.

4.2.2 Tolerances.

- a. General Philosophical Discussion. At this point in TWR test methodology, test tolerance specification is not well quantified. Test tolerance development for TWR is based upon a different laboratory test philosophy as opposed to the test philosophy contained in Methods 514.8 and 516.8. The reason for this change in philosophy is embedded in the implementation of TWR testing. TWR testing may involve replicating a combination of stationary Gaussian, stationary non-Gaussian, and nonstationary measured environments within a single time trace designated the reference time trace. Tolerance specification may be related to current tolerance specification in Methods 514.8 and 516.8, or be independently established based upon the nature of TWR testing. First, it is important to note that TWR does not provide a “*waveform control strategy*” that implies the satisfaction for the time control trace of each of the time/amplitude coordinates of every point within the reference time trace (satisfaction to within some predetermined amplitude tolerance, while totally satisfying the sampling time constraint). Exciter control and feedback hardware/software configurations to accomplish this to a bandwidth of 2000 Hz are currently not available. TWR implicitly “averages” the reference time trace (waveform) information over both time and frequency. There are two sources for the time and frequency averaging. The first source is through compensation of the voltage drive waveform by *linear convolution* of the exciter system impulse response function estimate with the reference time trace. The condition of system linearity is almost never satisfied so that the reference time trace is averaged over time through the linear convolution (as opposed to providing convolution through a two-dimensional non-stationary/nonlinear impulse response function that changes instantaneously in time). The second source is the implicit and nearly unavoidable averaging of significant amounts of energy from signals outside of the reference time trace bandwidth (i.e., the bandwidth for TWR control). These two sources of time/frequency averaging severely limit consideration of time point (or increment) by time point (or increment) amplitude tolerance limit specification between the reference and control time traces. Experience has shown that the distribution of the time point by time point difference between the reference and control

MIL-STD-810H
METHOD 525.2

time traces is almost always non-Gaussian distributed, leading to the need for a complex tolerance specification and interpretation. Even though this may seem to be a significant limitation for the implementation of TWR testing, it is important to realize that the focus of TWR is replication of a stochastic field environment for which any one measured sample time trace (out of a potentially infinite number of such traces) has a zero probability of occurrence. Because the exact probability structure of the “*true*” field environment is generally unknown, this implies that the test tolerance specification can be quite broad, and the objective of the test (be it structural integrity or functional capability) can be satisfied at the same time. In the broadest interpretation, this can border on concluding that if the reference and control time traces plotted side-by-side visually “look alike”, then tolerance in terms of random process theory and sample functions has been met, even though the time-point by time-point amplitude (TPP) difference between the reference and control traces may be substantial. In the tolerance consideration for this Method, although TPP provides an interesting display by plotting the reference time trace versus the control time trace along orthogonal axes (see Annex A), it is not recommended that TPP comparison be the major determiner for test tolerance satisfaction. Instead, recommend that time and frequency average estimates made over the same time frame on the reference and control time traces be used for tolerance specification. In particular, it is recommended that frequency based averages incorporated into ASD, SRS estimation, and time-based averages incorporated into mean-square (or root-mean-square) estimation be used in tolerance specifications whenever possible. Methods 514.8 and 516.8 incorporate test tolerances on ASD and SRS estimates, respectively. The tolerances in these two methods are easily interpreted, and generally are easily satisfied in TWR testing. With regards to time based averages, it is important to note that while the root-mean-square of the difference between two independently distributed Gaussian random variables is a function of the square-root of the sum of their variances, the difference of the root-mean-square levels of the two random variables (averaged over a certain number of realizations) may be an order of magnitude or more less. That is, the variance of an average of N variables from a probability distribution with variance σ^2 is σ^2/N . Annexes A and B discuss the form for tolerance specification in more detail. In the paragraphs to follow, the term “Specialized Test Tolerance Requirements” (STTR) will be used. Use of STTR recognizes that TWR testing may require a level of sophistication in environmental test tailoring not experienced in the standard methods. For example, materiel exposed to high levels of kurtosis may require TWR test methodology based upon field measurements. Such a specialized laboratory test may require verification of the kurtosis levels, and a detailed specification of the shape of the probability density function to ensure other probability distribution moments are acceptable. It is not feasible in this Method to prescribe acceptable tolerance limits for this scenario. Thus, such tolerance limits will be developed under the term STTR and will require trained analysts for specification and interpretation. This allows the focus in paragraphs 4.2.2b and 4.2.2c of a more practical nature.

- b. **Practical Tolerance Considerations.** Laboratory testing in another method that is implemented by using TWR test methodology should be under laboratory test tolerance requirements in the other method. For example, Method 516.8 provides tolerances on shock under the SRS methodology. For a measured shock time trace replicated under TWR test methodology, the same SRS based test tolerances should apply for comparison of the reference time trace SRS with the control time trace SRS. In general, tolerances specified for TWR test methodology should be *consistent with, and no broader than* laboratory test tolerances in other methods for testing with similar objectives. Relative to TWR test methodology on measured time traces of diverse form, measured mechanical response *time traces* and *portions of such time traces* may have any one of three characteristic forms.

- (1) The first form is that of Gaussian or non-Gaussian stationary random vibration.
- (2) The second form is that of a short duration high level transient or shock where the duration of the transient is much shorter than the periods of the lowest natural frequencies of interest for the materiel.
- (3) The third form is that of a non-stationary transient vibration having duration that substantially exceeds the period of the lowest natural frequency of the materiel.

A fourth form, too specialized for consideration here, might be classed as periodic repetition of an event for which test tolerance is established according to time trace ensemble statistics (see Method 519.8, Gunfire Shock). For TWR tolerance development, such tolerances *should not exceed* the tolerances provided for

MIL-STD-810H
METHOD 525.2

stationary random vibration and mechanical shock for the first and second forms, respectively. It is anticipated that a properly designed TWR test will easily meet the tolerance levels specified in both of these forms (Methods 514.8 and 516.8). The tolerances for the third form of non-stationary time trace are somewhat dependent upon the nature of the non-stationarity. Techniques for non-stationarity assessment in which time trace amplitude is a function of both time and frequency are available (see paragraph 6.1 references a and b). Some non-stationary time traces that have time invariant frequency characteristics can be represented by the Product Model (PM), and can be processed for tolerance purposes as stationary random vibration with a time-varying envelope. Annexes A and B should be consulted for details of TWR tolerance specification for non-stationary time traces. If it is unclear as to how to segment a TWR time trace, then (1) time-average test tolerances may be provided on the difference between the control and reference time traces, or (2) digital bandpass filtering may be performed on both the control and reference time traces to make common bandwidth comparisons. The Annexes should be consulted for such tolerance development.

- c. Tolerance Recommendations. In general, all test tolerances need to be established by some comparison in the time domain and frequency domain of the digitized reference and control time traces. Rudimentary comparison that might be taken for nominal test tolerances is usually performed by the vendor-supplied TWR software. The vendor will typically refer to the rudimentary comparison as “rms error.” Test laboratory personnel need to consult the vendor supplied TWR system manuals for such error considerations, and have a very clear understanding of the proper interpretation and meaning of such error; in particular, the segment size and averaging performed in order to establish the “rms error.” It is strongly advised that TWR test tolerances be developed independently of vendor supplied software, and verification of the satisfaction of TWR test tolerances be performed independently of vendor supplied software. In addition, in no case should vendor supplied software be relied upon for the specification of TWR test tolerances. However, it is vitally important that specified TWR test tolerances be correlated in some general manner with vendor supplied “rms error,” so that test interruption may be performed if large “rms error” implies specified test tolerance exceedance above a prescribed limit. If testing occurring in real time at levels exceeding the maximum test tolerance rms error limit by 10 percent, the test needs to be interrupted. Generally, it is essential that for a precise comparison (1) the reference and control time traces be band-limited to the exact SESA frequency band of interest, and (2) the reference and control time traces be maximally correlated by way of digital pre-processing (see Annex A). After such pre-processing, recommend the reference time trace be segmented into portions that might be considered stationary, short transient (or shock) and long transient. Generally, a 10 percent tapered cosine window should be applied to each of the segments such that the characteristic part of the time trace is scaled by unity, and the end points are zero. It is assumed that good signal processing practices are used to determine the basic estimates for deciding tolerance satisfaction (see Annex B). In particular, this may mean balancing the statistical random and bias error in the estimates. ASD and mean-square envelope estimates are susceptible to statistical processing errors that may distort the resulting estimates.
- (1) Stationary Gaussian or non-Gaussian (may include discrete components):
 - (a) Frequency domain: For a cosine windowed segment represented by a Gaussian or non-Gaussian stationary random time trace, tolerances are placed upon ASD estimates. The control time trace ASD estimate is to be consistent with the tolerances given in Method 514.8.
 - (b) Amplitude domain comparison (STTR): When the windowed segment of the reference time trace is non-Gaussian (incorporates skewness, kurtosis or both skewness and kurtosis), recommend the plotting of the reference and control along orthogonal axes be initially performed for visual inspection. This visual inspection should then be followed by an empirical quantile plot of reference time trace amplitudes versus control time trace amplitudes (qq plot). The qq point plot should approach a straight line at forty-five degrees to each axis. Confidence intervals on this line according to the sample size can be used for tolerance specification STTR. Histogram plots of the reference and control time traces for enhanced tail structure may provide useful visual inspection, and can be used for tolerance specification for STTR. Finally, estimates of the non-Gaussian probability distribution parameters may be compared between the reference and the control time traces, exercising caution since the parameter value estimates are subject to quite restrictive statistical error considerations. For a zero mean reference time trace, ensure single estimates of the overall time trace sample variance are within ± 10 percent of the reference time trace. Probability density of reference and control signals should be compared to observe skewness and kurtosis characteristics.

MIL-STD-810H
METHOD 525.2

- (2) Shock:
 - (a) Frequency domain: For an appropriately windowed segment represented by a shock, ensure the tolerance on the control time trace SRS estimate with 5 percent critical damping is within -6dB and+ 3dB of the reference time trace SRS estimate for at least a one-twelfth octave bandwidth resolution.
 - (b) Amplitude domain: For the segment, ensure the major (maximum absolute magnitude) positive and negative peaks (not to exceed 10 percent of all the reference time trace peaks in number) in the control time trace are within ± 20 percent magnitude of the corresponding peaks in the reference time trace (peak correspondence is based upon the fact that the control and reference time traces have zero phase shift between them).
- (3) Nonstationary (Product Model):
 - (a) Amplitude domain: For an appropriately windowed segment that can be represented by the “Product Model,” suggest the short-time average estimate of the control time trace envelope (time average root-mean-square level) be within ± 1 dB of the short-time average estimate of the reference time trace envelope, where the short-time averaging time (and time shift in average time estimates) is not to exceed 1percent of the total duration of the reference time trace.
 - (b) Frequency domain comparison: Ensure the normalized ASD estimate for the control time trace is within ± 3.0 dB (ratio of approximately 2) of the normalized ASD estimate for the reference time trace over a significant portion of the bandwidth. Note: this may seem a broad tolerance bound but generally the normalized ASD estimates have a restricted number of statistical degrees-of-freedom.

Annex A illustrates processing for test tolerance satisfaction. Annex B provides a table of analytical formulas and some preliminary test tolerance specifications that may be used to formally specify tailored test tolerance (in particular, for STTR). In cases where specified tolerances cannot be met, achievable tolerances should be established and agreed to by the cognizant engineering authority and the customer prior to initiation of the test.

Test interruptions can result from multiple situations. The following paragraphs discuss common causes for test interruptions, and recommended paths forward for each. Recommend test recording equipment remain active during any test interruption if the excitation equipment is in a powered state.

4.3 Test Interruption.

Test interruptions can result from a number of situations that are described in the following paragraphs.

4.3.1 Interruption Due To Laboratory Equipment Malfunction.

- a. General. See Part One, paragraph 5.11, of this Standard.
- b. Specific to this Method. When interruptions are due to failure of the laboratory equipment, analyze the failure to determine root cause. Drive, control and response time traces should be evaluated to ensure that no undesired transients were imparted to the test materiel during the test equipment failure. If the test item was not subjected to an over-test condition as a result of the equipment failure, repair the test equipment or move to alternate test equipment and resume testing from the point of interruption. If the test item was subjected to an over-test condition as a result of the equipment failure, notify the test engineer or program engineer responsible for the test materiel immediately. Conduct a risk assessment based on factors such as level and duration of the over-test event, spectral content of the event, cost and availability of test resources, and analysis of test specific issues to establish the path forward. In all cases, archive and analyze all available time trace information including drive, control, reference and monitor time traces, and thoroughly document the results. See Annex A for descriptions of common test types, and a general discussion of test objectives.

4.3.2 Interruption Due To Test Materiel Operation Failure.

Failure of the test materiel to operate as required during operational checks presents a situation with several possible options. Failure of subsystems often has varying degrees of importance in evaluation of the test materiel integrity. Selection of one or more options from a through c below will be test specific.

- a. The preferable option is to replace the test item with a “new” one, and restart the entire test.
- b. An alternative is to replace/repair the failed or non-functioning component or assembly with one that functions as intended, and restart the entire test. Conduct a risk analysis prior to proceeding since this option

MIL-STD-810H
METHOD 525.2

places an over-test condition on the entire test item, except for the replaced component. If the non-functioning component or subsystem is a line replaceable unit (LRU) whose life-cycle is less than that of the system test being conducted, it may be allowable to substitute the LRU and proceed from the point of interruption.

- c. For many system level tests involving either very expensive or unique materiel, it may not be possible to acquire additional hardware for re-test based on a single subsystem failure. For such cases, perform a risk assessment by the organization responsible for the system under test to determine if replacement of the failed subsystem and resumption of the test is an acceptable option. If such approval is provided, the failed component should be re-tested at the subcomponent level.

NOTE: When evaluating failure interruptions, consider prior testing on the same test item and consequences of such. (See Part One, paragraph 5.19).

4.3.3 Interruption Due To A Scheduled Event.

There are often situations in which scheduled test interruptions will take place. For example, in a tactical transportation scenario, the payload may be re-secured to the transport vehicle periodically (i.e., tie-down straps may be re-secured at the beginning of each day). Endurance testing often represents a lifetime of exposure; therefore it is not realistic to expect the payload to go through the entire test sequence without re-securing the tie-downs as is done in a tactical deployment. Many other such interruptions, to include scheduled maintenance events, are often required over the life-cycle of materiel. Given the cumulative nature of fatigue imparted by dynamic testing, it is acceptable to have test interruptions that are correlated to realistic life-cycle events. Document all scheduled interruptions in the test plan and test report.

4.3.4 Interruption Due to Exceeding Test Tolerances.

Exceeding the test tolerances defined in paragraph 4.2.2, or a noticeable change in dynamic response may result in a manual operator-initiated test interruption or an automatic interruption when the tolerances are integrated into the control strategy. In such cases, check the test item, fixture, and instrumentation to isolate the cause. In general, the vendor means of assessing the test adequacy in real time as described in Paragraph 4.2.2c will be relied upon (based upon its general correlation to the specified test tolerances) for initiating test interruption. More detailed test tolerance assessment is completed after the test has been performed. Time average root-mean-square error between the reference and the control time traces that is above a test tolerance limit of 10 percent will be adequate for initiation of test interruption.

- a. If the interruption resulted from a fixturing or instrumentation issue, correct the problem and resume the test.
- b. If the interruption resulted from a structural or mechanical degradation of the test item, the problem will generally result in a test failure and requirement to re-test unless the problem is allowed to be corrected during testing. If the test item does not operate satisfactorily, see paragraph 5 for failure analysis, and follow the guidance in paragraph 4.3.2 for test item failure.

4.4 Instrumentation.

In general, acceleration will be the quantity measured to meet the specification for the selected procedure, however similar instrumentation concerns apply to other sensors. Ensure laboratory acceleration control measurements correspond to field acceleration reference measurements. This is usually accomplished by mounting the test item accelerometer for control in the same SESA location as that on the field measurement materiel from which the reference time trace was extracted.

- a. Accelerometer. In the selection of any transducer, one should be familiar with all parameters provided on the associated specification sheet. The device may be of the piezoelectric or piezoresistive type. Key performance parameters for an accelerometer follow:
 - (1) Frequency Response: A flat frequency response within ± 5 percent across the frequency range of interest is required.

MIL-STD-810H
METHOD 525.2

- (2) Transverse sensitivity should be less than or equal to 5 percent.
 - (3) Nearly all transducers are affected by high and low temperatures. Understand and compensate for temperature sensitivity deviation as required. Temperature sensitivity deviations at the test temperature of interest should be no more than $\pm 5\%$ relative to the temperature at which the transducer sensitivity was established.
 - (4) Base Strain sensitivity should be evaluated in the selection of any accelerometer. Establishing limitations on base strain sensitivity is often case specific based upon the ratio of base strain to anticipated translational acceleration.
 - (5) Amplitude Linearity: It is desired to have amplitude linearity within 1 percent from 5 percent to 100 percent of the peak acceleration amplitude required for testing.
- b. Other measurement devices. Any other measurement devices used to collect data must be demonstrated to be consistent with the requirements of the test.
 - c. Signal conditioning. Use only signal conditioning that is compatible with the instrumentation requirements of the test, and is compatible with the requirements and guidelines provided in paragraph 6.1, reference b.

4.5 Test Execution.

4.5.1 Preparation for Test.

Carefully examine the reference time trace for validity. Ensure the reference time trace is band limited according to the band limits of the exciter and control system software. By filtering, remove any high low-frequency components that will cause a displacement over-travel condition or velocity limit violation for the exciter. Make force requirement estimates based upon peak acceleration in the reference time trace, and the overall mass to be driven by the exciter, and compare this to the exciter force limits. If possible, integrate the acceleration time trace to obtain a velocity trace, and subsequently integrate the velocity trace to obtain a displacement trace to ensure the exciter is capable of reproducing the acceleration time trace without impacting its stops. Impacting stops, even in a cushioned hydraulic actuator, will typically result in materiel damaging accelerations. If integration is impractical or deemed likely inaccurate, the system may be operated using a dummy mass to determine if the available exciter stroke is sufficient. Generally, the vendor software estimates for maximum velocity and displacement should be verified, and some advanced signal processing procedures should be applied.

CAUTION: Integration is a difficult task that may provide unreliable answers. Using a technique such as a wavelet transformation, recommend removal of DC bias or very low frequency drift that falls below the minimum frequency of interest without imposing a phase lag.

4.5.1.1 Preliminary Steps.

Deciding upon the strategy for TWR compensation of the reference time trace, i.e., determining the exciter drive voltage, is a very important and potentially time-consuming task. The vendor approach to reference time trace compensation must be clearly understood. The advantages and disadvantages of time and frequency compensation error reduction strategies must be clearly understood. Boundary conditions and impedance mismatches almost always require maximum use of all the vendor software strategies for compensation. Use of exciter slip tables present special challenges for reference time trace compensation. Vendor software will generally allow compensation on (1) a band limited random signal, (2) a reduced level of the reference time trace, or (3) the full level reference time trace as the test progresses or as accumulated from previous testing at full level. Some vendor software may allow different compensation functions (transfer functions) on different portions of the reference time trace. It is recommended that testing be initially performed on a dynamic simulant item that represents the dynamic properties of the materiel to be tested to ensure the reference time trace can be properly compensated and accurately replicated. Remember that the bandwidth of the control time trace reflects the response of the dynamic simulation item or the materiel, and may be substantially broader than the bandwidth of the reference time trace. TWR “control” is generally active only over the bandwidth of the reference time trace, allowing uncompensated response outside of this bandwidth. Vendor software may permit control beyond the band limit of the reference time trace. If the bandwidth differences (reference versus control) can be detected early on, this will be helpful in interpreting the results of the test, particularly with respect to meeting test tolerances.

MIL-STD-810H
METHOD 525.2**4.5.1.2 Pretest Checkout.**

Verify that each of the following check list items is established prior to initiation of the test

- a. Test fixture requirements.
- b. Test fixture modal survey requirements / procedure.
- c. Test item/fixture modal survey requirements / procedure.
- d. Control and monitor measurement locations correlate with the configuration for which the reference time trace was obtained.
- e. Test tolerances.
- f. Requirements for combined environments.
- g. Test schedule(s) and duration of exposure(s).
- h. Axes of exposure.
- i. Test shutdown procedures for test equipment or test item problems, failures, etc.
- j. Test interruption recovery procedure. (See paragraph 4.3.)
- k. Test completion criteria including any post processing for a refined tolerance assessment (STTR).
- l. Test requirements (force, acceleration, velocity, displacement) can be met. Seek approval for variation if required. Document any variation.
- m. Allowable adjustments to test item and fixture (if any); these must be documented in test plan and the test report.
- n. Adequate digital data storage requirements.

4.5.2 Procedure Specific.

The following steps provide the basis for collecting the necessary information under TWR testing.

4.5.2.1 Procedure I - SESA Replication of a Field Measured Materiel Time Trace Input/Response.

- Step 1 Following the guidance of paragraph 6.1, reference b, select the test conditions and mount the test item (or dynamic simulant item) on the vibration exciter. Select accelerometers and analysis techniques that meet the criteria outlined in paragraph 6.1, reference b.
- Step 2 If required; perform an operational check on the test item at standard ambient conditions. If the test item operates satisfactorily, proceed to Step 3. If not, resolve the problems and repeat this step.
- Step 3 Subject the test item (or dynamic simulant) to the system identification process that determines the compensated exciter drive voltage. This may include a careful look at the component parts of the reference time trace, i.e., stationary vibration, shock, transient vibration; and determination of the potential time variant properties of the compensating function. If a dynamic simulant is used, then replace the dynamic simulant with the test item after compensation.
- Step 4 Subject the test item in its operational configuration to the compensated waveform. It is often desirable to make an initial run at less than full level to ensure proper dynamic response and validate instrumentation functionality.
- Step 5 Record necessary data, paying particular attention to the vendor software supplied test error indicator and, in general, the control acceleration time trace that can be post processed to demonstrate tolerance satisfaction.
- Step 6 Perform an operational check on the test item and record the performance data as required. If failure is noted, follow the guidance in paragraph 4.3.2.
- Step 7 Repeat Steps 4, 5, and 6 for the number of replications called out in the requirements document, or a minimum of three times for statistical confidence provided the integrity of the test configuration is preserved during the test.

MIL-STD-810H
METHOD 525.2

Step 8 Document the test series including the saving of all control and monitor digital time traces, and see paragraph 5 for analysis of results.

4.5.2.2 Procedure II - SESA Replication of an Analytically Specified Materiel Time Trace Input/Response.

Follow the guidance provided in Steps 1-8 in Paragraph 4.5.2.1 subsequent to scaling the reference time trace per the scaling guidance provided in paragraph 1.2.6.

4.5.3 Data Analysis.

Ideally, information from the control time trace in the time and frequency domains should be nearly identical to that information contained in the reference time trace. Vendor supplied test error assessment provides a preliminary indication of the replication efficacy. If vendor supplied test error assessment consistently displays less than, e.g., 5 percent time average rms error over blocks of reference/control data, additional analysis may be unnecessary. For production testing, reliance on consistency of vendor supplied rms error is highly desirable. For single item tests that are unique and for which vendor rms error provides values greater than acceptable, then differences between the reference and control time traces must be assessed in detail. The following guidance is provided.

- a. Rudimentary analysis to ensure the test tolerances are met is usually performed within the TWR vendor software. Laboratory personnel should consult the vendor supplied TWR system documentation, and clearly understand the determination of these test tolerances. In most cases, this will require direct contact with the vendor of the TWR system.
- b. More extensive data analysis can be performed to ensure test tolerances are met based upon reference and control time trace ASCII files, with off line specialized software according to procedures illustrated in Annex A and discussed in Annex B.
- c. Detailed data analysis for purposes of establishing parameters for a random process or other purposes may be performed, but must be consistent with the information provided in the Annexes, and best data processing procedures as defined in paragraph 6.1, references a or b. Such detailed analysis may be beyond the scope of defined tolerances, and is to be used for report information purposes only.
- d. Processing of monitor time trace information for modeling, failure assessment, or other purposes must follow the same guidelines as for the control time trace.

5. ANALYSIS OF RESULTS.

In addition to the guidance provided in Part One, paragraphs 5.14 and 5.17; and Part One, Annex A, Tasks 405 and 406, the following information is provided to assist in the evaluation of the test results. Analyze in detail any failure of a test item to meet the requirements of the specification, and consider related information such as:

- a. Information from the control accelerometer configuration, including a digital record of the control time trace.
- b. The vendor TWR software test tolerance information.
- c. Application of one or more of the techniques illustrated in Annex A and elaborated on in Annex B for detailed comparison of the reference time trace to the control time trace.

5.1 Physics of Failure.

Analyses of vibration related failures must relate the failure mechanism to the dynamics of the failed item and to the dynamic environment. It is insufficient to determine that something failed due to high cycle fatigue or wear. Include in failure analyses a determination of resonant mode shapes, frequencies, damping values and dynamic strain distributions, in addition to the usual material properties, crack initiation locations, etc.

5.2 Qualification Tests.

When a test is intended to show formal compliance with contract requirements, recommend the following definitions:

- a. Failure definition. Materiel is deemed to have failed if it suffers permanent deformation or fracture; if any fixed part or assembly loosens; if any moving or movable part of an assembly becomes free or sluggish in operation; if any movable part or control shifts in setting, position or adjustment, and if test item performance does not meet specification requirements while exposed to operational or endurance test levels. Ensure this statement is accompanied by references to appropriate specifications, drawings, and inspection methods.

MIL-STD-810H
METHOD 525.2

- b. **Test completion.** A TWR qualification test is complete when all elements of the test item have successfully passed a complete test. When a failure occurs, stop the test, analyze the failure and repair the test item. Continue the test until all fixes have been exposed to a complete test. Qualified elements that fail during extended tests (tests extended beyond LCEP requirements) are not considered failures, and can be repaired to allow test completion.

5.3 Other Tests.

For tests other than qualification tests, prepare success and/or failure criteria and test completion criteria that reflect the purpose of the tests.

6. REFERENCE/RELATED DOCUMENTS.**6.1 Referenced Documents.**

- a. Bendat, Julius S. and Allan G. Piersol, Random Data Analysis and Measurement Procedures, 4th Edition, John Wiley & Sons, Inc., New York, 2010.
- b. Handbook for Dynamic Data Acquisition and Analysis, IEST-RD-DTE 012.2, Institute of Environmental Sciences and Technology, Arlington Place One, 2340 S. Arlington Heights Road, Suite 100, Arlington Heights, IL 60005-4516.
- c. Merritt, Ronald G., “Application of Mixed Effects Models to a Collection of Time Trace Product Models,” Proceedings of the 77th Shock and Vibration Symposium, Nov. 2006; Shock & Vibration Exchange (SAVE), 1104 Arvon Road, Arvon, VA 23004.
- d. Stuart, Alan and J. Keith Ord, Kendall’s Advanced Theory of Statistics, 5th Edition Volume 1 Distribution Theory, Oxford University Press, New York NY, 1987.

6.2 Related Documents.

- a. Bickle, Larry W. and Ned R. Keltner, Estimation of Transient Measurement Errors, SAND78-0497, August 1978.
- b. Shock and Vibration Handbook, 5th Edition, Edited by Cyril M. Harris and Allan G. Piersol, McGraw-Hill, New York NY, 2002.
- c. Egbert, Herbert W. “The History and Rationale of MIL-STD-810 (Edition 2)”, January 2010; Institute of Environmental Sciences and Technology, Arlington Place One, 2340 S. Arlington Heights Road, Suite 100, Arlington Heights, IL 60005-4516.

(Copies of Department of Defense Specifications, Standards, and Handbooks, and International Standardization Agreements are available online at <https://assist.dla.mil>.)

Requests for other defense-related technical publications may be directed to the Defense Technical Information Center (DTIC), ATTN: DTIC-BR, Suite 0944, 8725 John J. Kingman Road, Fort Belvoir VA 22060-6218, 1-800-225-3842 (Assistance--selection 3, option 2), <http://www.dtic.mil/dtic/>; and the National Technical Information Service (NTIS), Springfield VA 22161, 1-800-553-NTIS (6847), <http://www.ntis.gov/>.

MIL-STD-810H
METHOD 525.2

(This page is intentionally blank.)

MIL-STD-810H
METHOD 525.2 ANNEX A

METHOD 525.2, ANNEX A
SESA POST-TEST ANALYSIS ILLUSTRATION FOR TEST TOLERANCE ASSESSMENT

1. PURPOSE.

This Annex is designed to provide general guidelines for post-test analysis for SESA TWR testing. It displays some potentially useful tools for comparison of “reference” and “control” time traces and processing the difference between these time traces. Post-test analysis provides insight into development of test tolerance limits for single axis TWR.

2. GENERAL PHILOSOPHY FOR TWR TESTING.

Broadband TWR, i.e., from 5 Hz to 2000+ Hz, is relatively new to dynamic laboratory testing with electrodynamic force exciters. The same comment applies to electrohydraulic force exciters only over a more limited bandwidth. The philosophy for TWR testing, including test tolerance development, is still evolving. The post-test analysis rationale displayed below will doubtlessly be augmented/refined/enhanced with portions eliminated, however fundamentals behind the analysis rationale will remain.

The general term “*replication error*” will be used with regard to the comparison of the difference between the control and reference time traces. SESA post-test analysis quantitatively compares the deterministic test input reference time trace, $r(t)$ (or sampled sequence $r[n]$ for $n = 1, 2, \dots, N$), symbolic “ r ,” with the stochastic test output control time trace, $c(t)$ (or sampled sequence $c[n]$ for $n = 1, 2, \dots, N$), symbolic “ c .” For comparison, it is convenient to have available a stochastic difference time trace defined as:

$$s(t) = c(t) - r(t) \text{ (or sampled sequence } s[n] = c[n] - r[n], n = 1, 2, 3, \dots, N \text{), symbolic "s."}$$

The difference time trace represents the “replication error.” The reference and control time traces are assumed to be perfectly correlated in time so that the difference time trace is valid, and generally vendor software is very reliable in supplying reference and control digital time traces that are perfectly correlated. A **time/amplitude point-by-time/amplitude point** (TPP) assessment of the time traces can be made, and an estimate of replication error determined. Annex B addresses in more detail the statistical implications of TPP. Generally, vendors will make available a drive voltage time trace for potential use in understanding the test limitations, i.e., fixture resonance compensation, impedance mismatch, etc. This time trace must be preprocessed in the same manner as r , c , and s . The drive time trace is of no concern in the illustration to follow. Discussion appears in both this Annex and Annex B concerning **time/amplitude average-by-time/amplitude average** (STA) assessment for tolerance limit analysis – an alternative to TPP. Application of these procedures for tolerance error assessment will be mentioned in this Annex and in Annex B. Generally, direct comparison of time average estimates of r and c is much less desirable than either examining statistics on or statistics on a time averaged version of s . Interpretation of differences between time average estimates is more difficult.

3. DESCRIPTION OF REFERENCE TIME TRACE.

The time trace selected for illustration is one unidentified band limited field measured acceleration time trace used to assess the performance of the vendor software for a single axis exciter configuration. Test item configuration including fixturing was of no concern. The simplicity of the TWR test provides for replication error that is smaller than that encountered in general testing scenarios where boundary conditions and impedance mismatches become important. Figure 525.2A-1 displays the unprocessed reference time trace acceleration measured in the field.

MIL-STD-810H
METHOD 525.2 ANNEX A

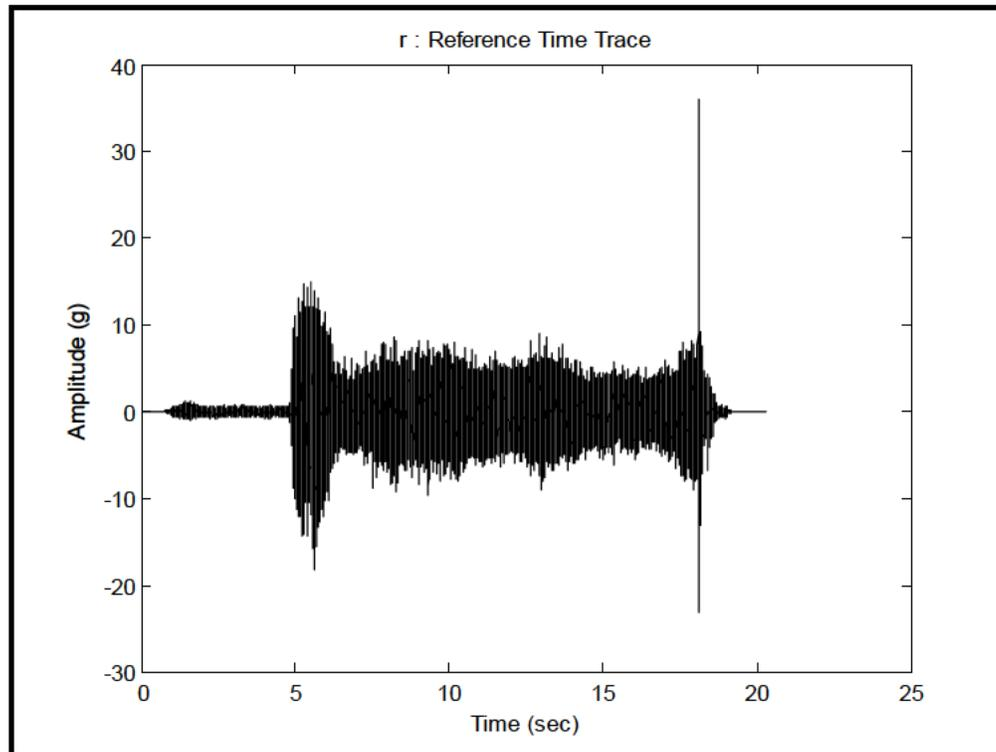


Figure 525.2A-1. Field measured acceleration reference time trace.

The time trace is band limited between 1 Hz and 2000 Hz, and consists of an initial and final low level stationary random vibration (augmented with some analytically generated zeros), along with a form of comparatively high level transient vibration, stationary random vibration and shock in succession. This visual assessment of the reference time trace is a key to examining the test performance adequacy. Under standard vendor vibration and shock system software, it would not be possible to test materiel to this form of time trace. The time trace was submitted for TWR testing under ambient conditions on an electrodynamic exciter using a vendor-supplied TWR software package. The “control accelerometer” was mounted on both the exciter head and on a conventional slip table. Even though TWR “control” is between 10 Hz and 2000 Hz, the sample rate of the reference time trace ASCII file is 25600 samples per second. The particular TWR vendor software re-sampled the waveforms to 24576 samples per second prior to testing. The Nyquist frequency is $24576/2=12288$ Hz. Most frequency domain plots will be restricted to 4000 Hz, and basic TWR control is out to 2000 Hz. The field measured time trace should display a bandwidth that exceeds the TWR control bandwidth to as much as an octave above and below the upper and lower control bandwidth limits, respectively. For demonstration of the effect of different boundary conditions, results of the testing will be displayed for the control time trace from the exciter head (designated (H)) and the exciter slip table (designated (S)).

4. TIME TRACE PRE-PROCESSING.

4.1 Introduction.

Not many post-test analysis procedures (independent of vendor supplied test analysis) have been formally established and agreed upon for quantifying the replication error. For one-of-a-kind type testing with a unique reference time trace, some reliance should be made upon custom software in post-test analysis to verify test tolerance satisfaction.

Figure 525.2A-2 displays the TWR control time traces for (H) and (S) configurations (along with the same reference time trace) prior to beginning of preprocessing where the time traces have been truncated for convenience.

MIL-STD-810H
METHOD 525.2 ANNEX A

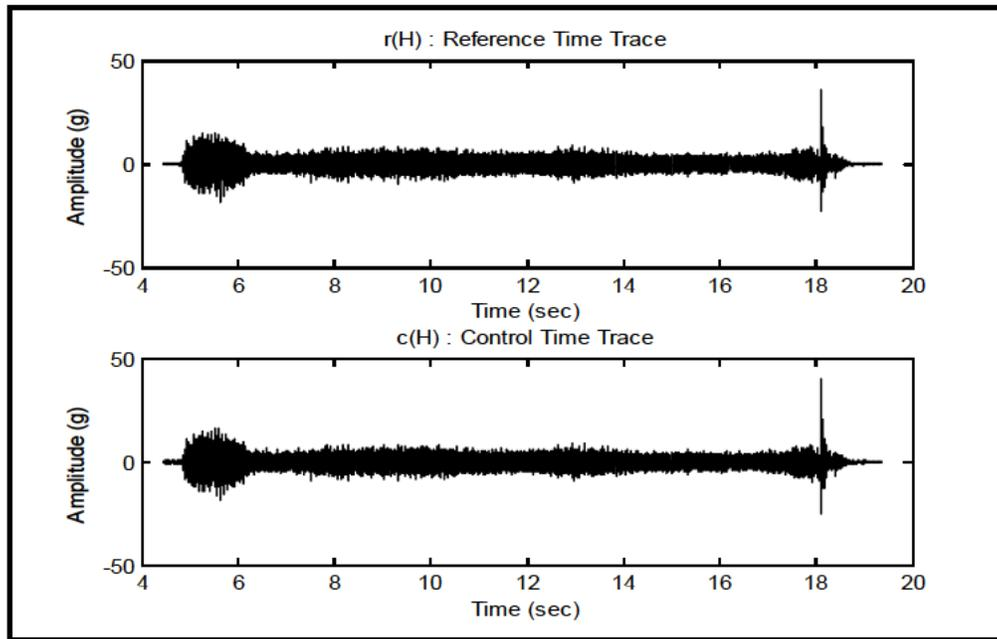


Figure 525.2A-2a. Exciter head (H) (reference/control time traces prior to post-test preprocessing).

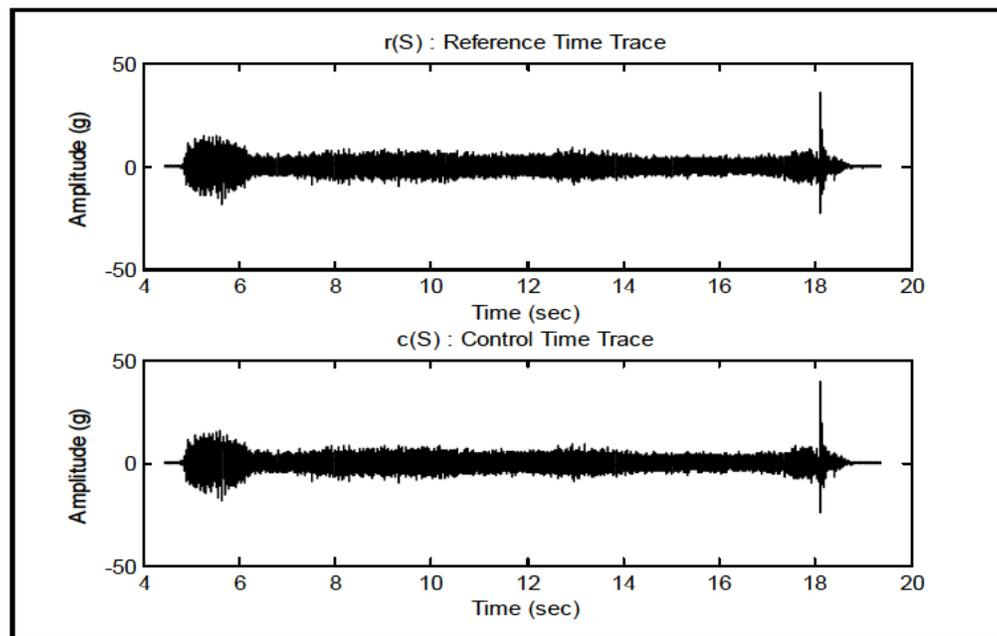


Figure 525.2A-2b. Exciter slip table (S) (reference/control time traces prior to post-test preprocessing).

Before the reference and control time traces are processed and the difference time trace is generated, some preprocessing is necessary. Preprocessing must be performed in both the time and frequency domains. The following preprocessing procedures will be discussed in turn:

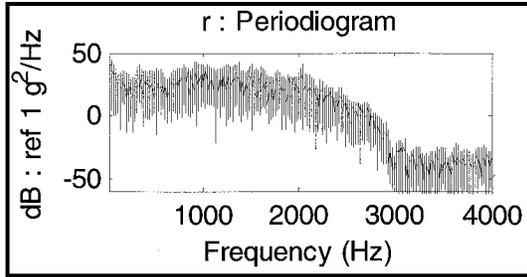
- a. Frequency Band Limiting.
- b. Time Trace Correlation.
- c. Time Trace Segment Identification.

MIL-STD-810H
METHOD 525.2 ANNEX A**4.2 Frequency Band Limiting.**

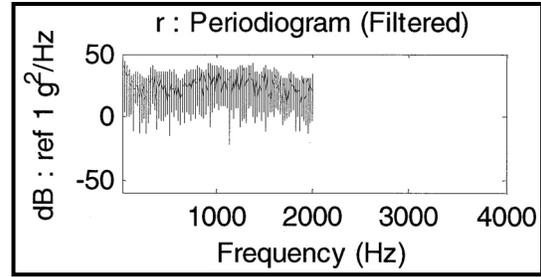
The objective of frequency band limiting is to ensure for time trace comparison, the reference and control time traces exist over the same exact frequency band (generally a bandwidth coincident with the TWR control bandwidth). The importance of this operation cannot be over emphasized. If the control time trace has significant high frequency information not contained in the reference time trace (as a result of boundary conditions or impedance mismatch), this will be reflected in any TPP amplitude comparisons. The band pass filter to provide a common bandwidth for the time traces is selected such that the minimum of the reference bandwidth and the control bandwidths is established. This common bandwidth may be specified as, e.g., 10 Hz to 2000 Hz, or determined by examining the magnitude of a periodogram estimate for both time traces. The frequency band limiting operation is performed on both the reference and control time traces, and always performed before time trace correlation considerations. Unless the time traces are excessive in length, a single block rectangular window FFT magnitude (periodogram) plotted in dB for both the reference and control time traces is satisfactory for identifying the common bandwidth. For excessively long time traces, the Welch method of spectrum computation may be employed for common bandwidth identification. To obtain the common bandwidth, a standard bandpass filter may be applied, making sure to preserve filter phase linearity, in obtaining the reference and control time traces. Figure 525.2A-3 provides single block periodograms for the reference and control time traces before and after bandpass filtering.

NOTE: With regard to frequency band-limiting, it is very important that for any field time trace measurement program designed to provide input to TWR laboratory testing, the bandwidth of the field measurements exceeds by definition, the bandwidth of interest for laboratory testing (TWR test control bandwidth). For example, if test specifications call for a 10 Hz to 2000 Hz laboratory test bandwidth, the field time trace measurements must exceed 2000 Hz, e.g., 4000 Hz, in order to provide a reference time trace with sufficient bandwidth to compare with the unprocessed control time trace resulting from TWR laboratory testing. Less critically field measurements would have frequency content below 10 Hz, e.g., 5 Hz. The rationale behind this is as follows. Almost certainly the laboratory test will exhibit energy out of the test specification frequency band of interest or the exciter test control bandwidth as a result of mismatch of materiel/test fixture/exciter impedance/boundary conditions. To directly compare the field reference time trace (before bandwidth limiting as a TWR input) with the unprocessed laboratory control time trace, (even though the reference time trace may have been bandlimited for laboratory test), the field measured reference time trace must have a bandwidth consistent with the unprocessed laboratory control time trace, i.e., a bandwidth that encompasses the bandwidth of the unprocessed laboratory control time trace. Thus, bandlimiting for comparison of reference and control time traces must be in accord with the most significant energy in the unprocessed laboratory control time trace (that likely exceeds the test specification bandwidth). Comparison for purposes of time trace peak modeling for the reference and control time trace is particularly sensitive to frequency bandlimiting considerations. To compare reference and control time trace information in terms of the full bandwidth that the materiel experienced in laboratory test, the laboratory test control bandwidth must determine the bandwidth for comparison. In the example provided here the field measured reference time trace was bandlimited to 2000 Hz (by measurement system design without TWR consideration) thus, by necessity, in comparison, the measured reference time trace somewhat “incorrectly” controls bandwidth for comparison. As noted, TWR testing has important implications for field measurement system design.

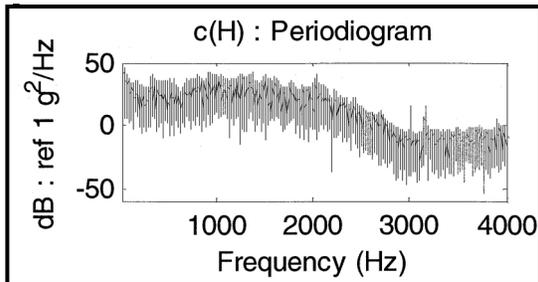
MIL-STD-810H
METHOD 525.2 ANNEX A



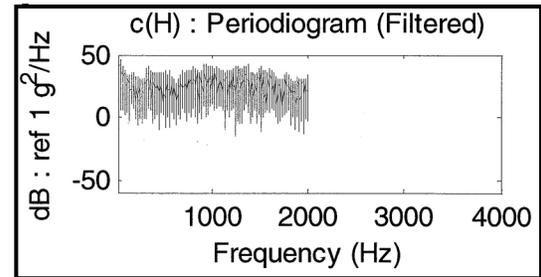
(a) Reference Time Trace



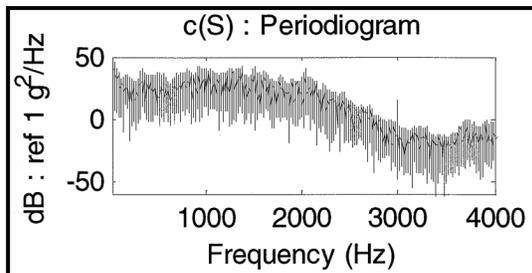
(b) Bandlimited Reference Time Trace (10 Hz – 2000 Hz)



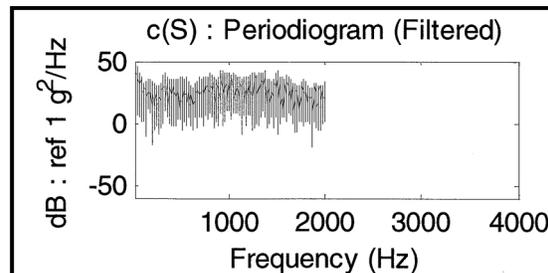
(c) Control Time Trace Exciter Head (H)



(d) Bandlimited Control Time Trace Exciter Head (H) (10 Hz – 2000 Hz)



(e) Control Time Trace Slip Table (S)



(f) Bandlimited Control Time Trace Slip Table (S) (10 Hz – 2000 Hz)

Figure 525.2A-3. Reference/control time trace periodograms for frequency band limiting through FFT window filtering.

Based upon examination of the periodograms for both time traces in Figure 525.2A-2, the very low frequency information (below 10 Hz), and the very high frequency information (above 2000 Hz) is filtered out. The frequency *analysis bandwidth* for this operation is 0.067 Hz.

4.3 Time Trace Correlation.

After a common frequency bandwidth has been established, it is essential that the band limited reference and control time traces be “perfectly” or “maximally” correlated in time (i.e., one time trace is not shifted in time relative to the other time trace) for TPP assessment. If the vendor software does not guarantee this perfect correlation in time, the degree of correlation must be checked. To perform this check and take corrective action, the cross-covariance function estimate is determined, and the time traces shifted relative to one another, such that the peak in the cross-covariance function estimate appears at the zero cross-covariance lag. This computation should be performed, if possible, on a reasonably stationary segment of the time trace. It is unnecessary to perform the correlation computations over the entire trace, but only necessary to get a long-enough segment such that the degree of shift can be determined with

MIL-STD-810H
METHOD 525.2 ANNEX A

confidence (dependent upon the accuracy of the covariance function estimate). Figure 525.2A-4 provides a biased cross-covariance function estimate between the band-limited reference and control time traces.

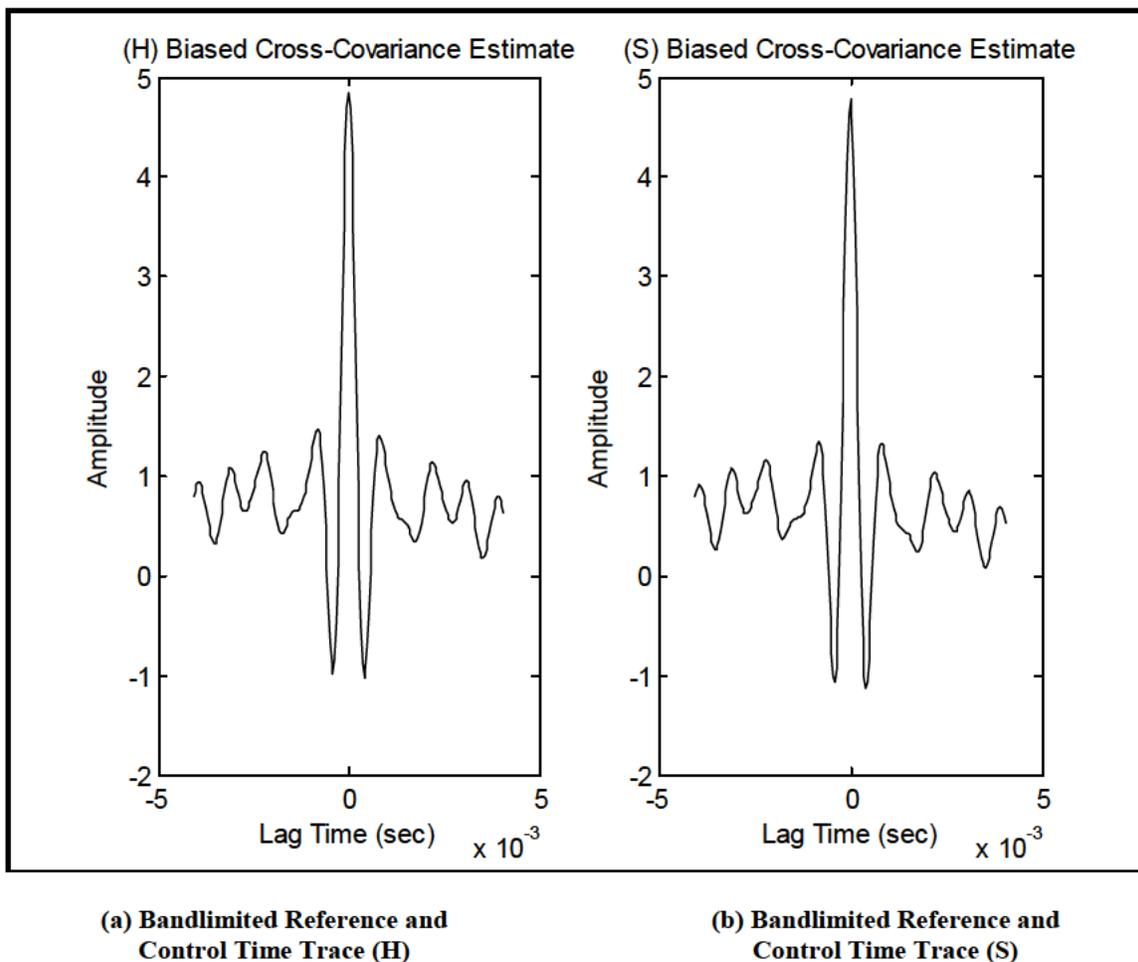


Figure 525.2A-4. Cross-covariance function estimates between reference and control time traces.

By examining the cross-correlation estimate region near a lag of zero seconds, it is apparent that the reference and control time traces are in phase, and no shifting of one time trace relative to the other is necessary.

4.4 Time Trace Segment Identification.

It is tacitly assumed that the reference and control time traces are preserved in such a way that (1) they are band-limited to the exact frequency band, and (2) they are simultaneously sampled at the SESA sample rate and over the exact time interval, providing no phase shift between the traces. Conditions in (1) and (2) have been met in paragraphs 4.2 and 4.3 (in this Annex), respectively. The purpose of time trace segment identification is to break the time trace into component parts that may be assessed independently for test replication error. There is no known single analysis procedure that can *consistently* assess the replication error for all six forms of time trace components identified in paragraph 1.2.3 of this Method. Figure 525.2A-5 reveals the five segments into which the *r*, *c*, and *s* time traces can be divided.

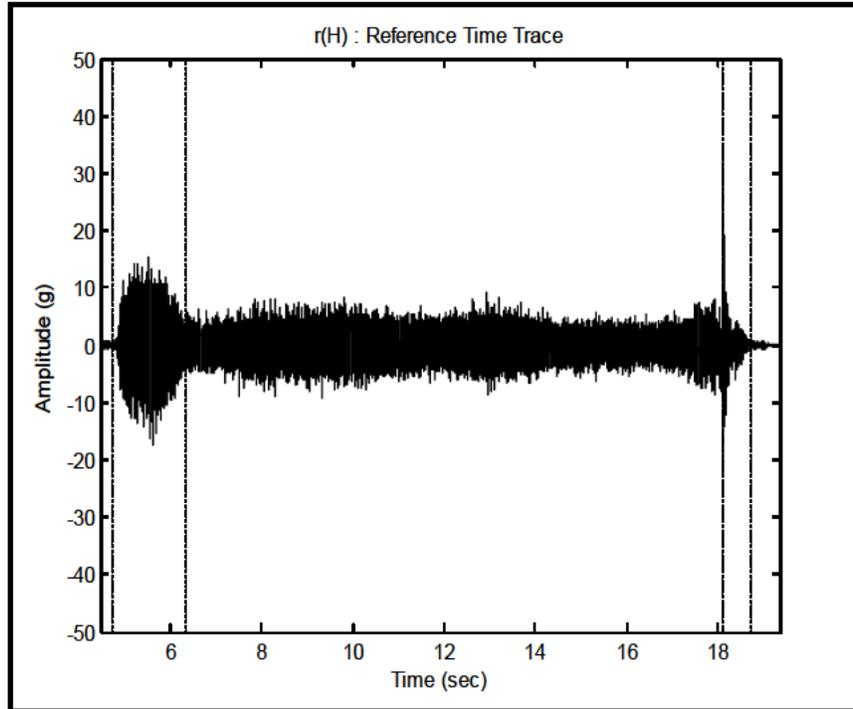
MIL-STD-810H
METHOD 525.2 ANNEX A

Figure 525.2A-5. Time trace segment identification from previously truncated reference time traces.

The first and fifth segments represent low level pre- and post-test acceleration of no interest for test tolerance consideration. The second segment represents a transient vibration, the third segment stationary random vibration, and the fourth segment a shock. For further processing purposes, the three segments of interest are extracted by use of a rectangular window over the duration of the segment. The three segments are displayed in Figures 525.2A-6 through 525.2A-8.

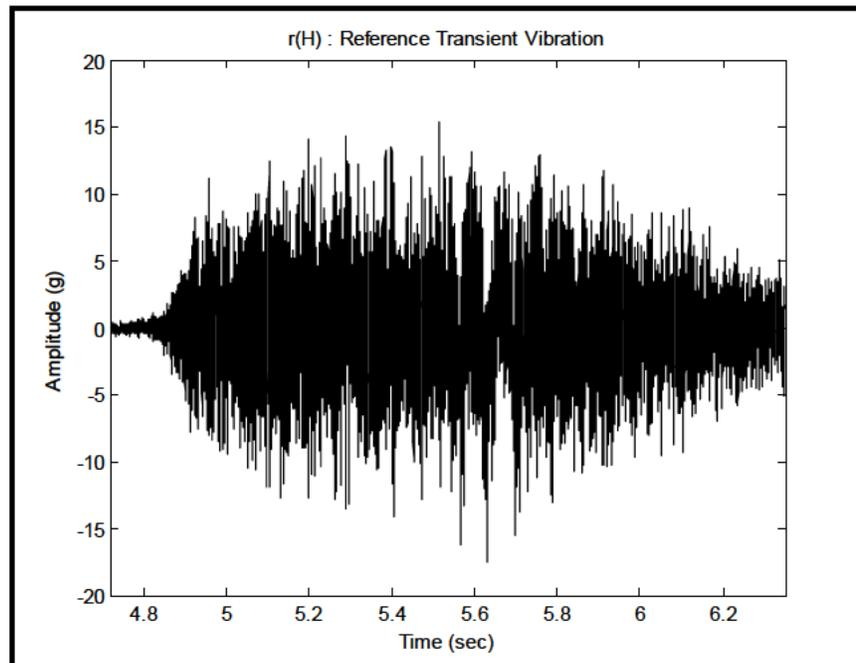


Figure 525.2A-6. Transient vibration reference time trace segment.

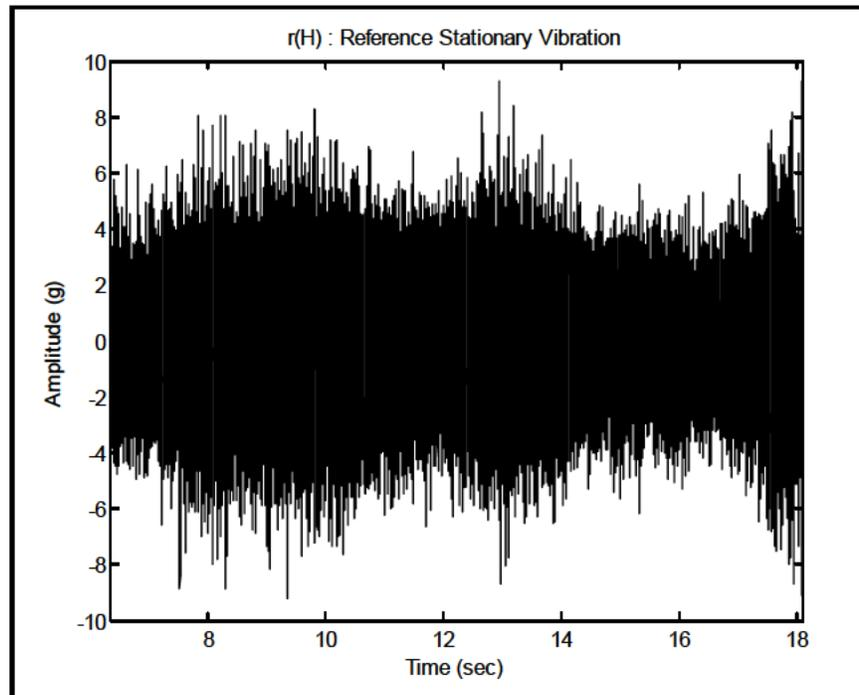
MIL-STD-810H
METHOD 525.2 ANNEX A

Figure 525.2A-7. Stationary random vibration reference time trace segment.

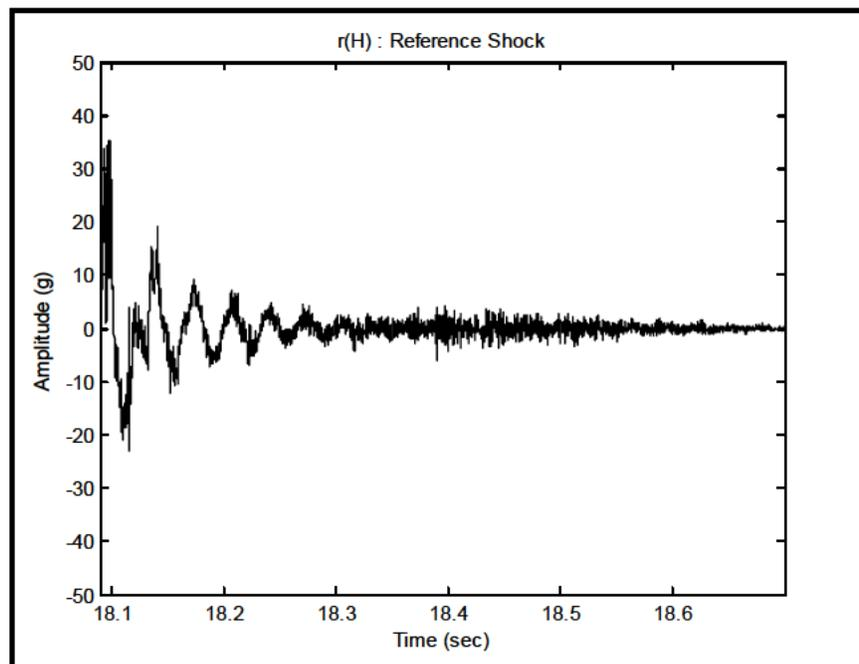


Figure 525.2A-8. Shock reference time trace segment.

For materiel particularly sensitive to a band or bands of frequencies, both time traces may be filtered (phase linearity preserved) into a number of bands, and post-processing performed on the band or bands individually. It is quite acceptable to decide and agree upon (before laboratory testing) a band-pass filter strategy that will be acceptable for assessing replication error. This form replication error assessment will not be pursued further here.

MIL-STD-810H
METHOD 525.2 ANNEX A

5. POST-TEST PROCESSING FOR TPP.

From pre-processing, three individual segments of different form exist along with the overall time trace. For reference purposes, the overall difference time trace along with TPP root-mean-square level are displayed in Figures 525.2A-9a and 525.2A-9b. In addition, the difference of the differences is provided in Figure 525.2A-9c.

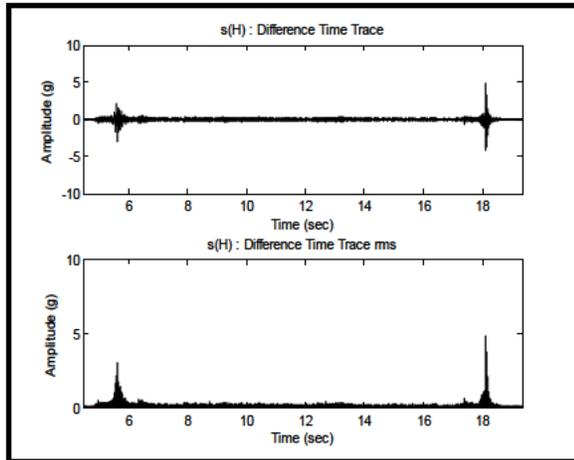


Figure 525.2A-9a. Difference Exciter (H).

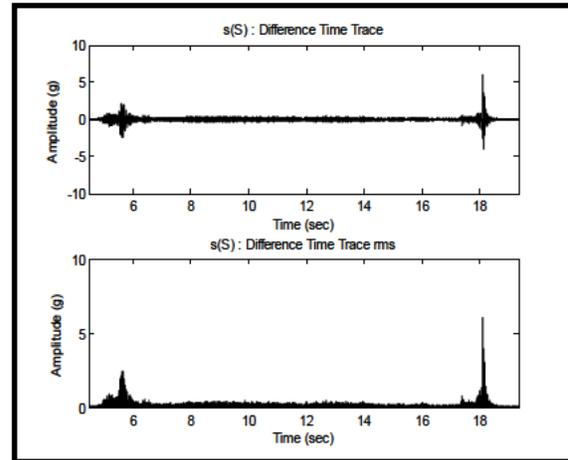


Figure 525.2A-9b. Difference Exciter (S).

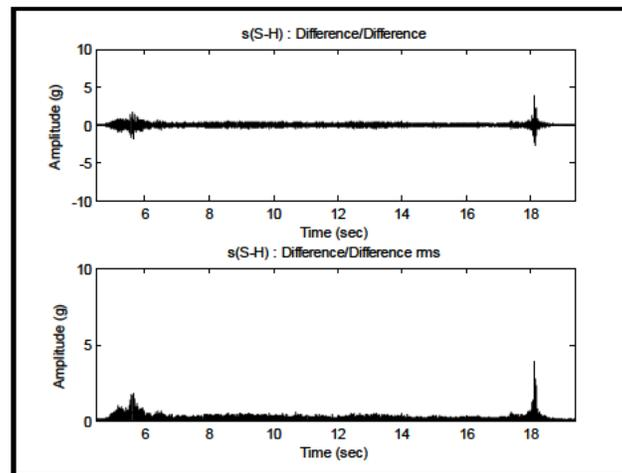


Figure 525.2A-9c. Time Trace of Difference of the Differences ((S) – (H)).

Figures 525.2A-9a-9c. Plots of overall difference time trace with root-mean-square.

In this particular case, TPP difference $s(H)$ and $s(S)$ may approach 5g, whereby the reference time trace was bounded by 40g in the positive and negative directions. This would suggest that, in certain parts of the time trace, the normalized random error might approach 0.125, i.e., 12.5 percent. The rudimentary overall maximum and minimum statistics for the time traces are as follows: $r(H)$ min/max $-22.84/35.24$; $c(H)$ min/max $-24.28/39.76$; and $s(H)$ min/max $-4.11/4.78$; $c(S)$ min/max $-23.85/39.03$; and $s(S)$ min/max $-3.95/6.08$. The differences between response on the head of the shaker (H) and the shaker slip table (S) are reasonably nominal, so that only results for the shaker head will be provided below. When reviewing several test measurements, it is usually desirable to provide comprehensive post-test analysis on one set of measurements, and infer that similar analysis on the other measurements. The segments will now be processed in turn according to meaningful and easy to interpret estimates.

MIL-STD-810H
METHOD 525.2 ANNEX A

6. TPP TRANSIENT VIBRATION.

Figure 525.2A-10 displays the transient vibration time trace information, from which the general form of the transient vibration is preserved, and the difference is reasonably nominal. There is an apparent low frequency component in the time traces between 5.58 and 5.70 seconds. Such a dominant low frequency component could preclude strict product model assumptions for post processing. However, generally, the product model is reasonably robust with regard to change of frequency, i.e., the momentary change in frequency character is averaged in over the entire record length.

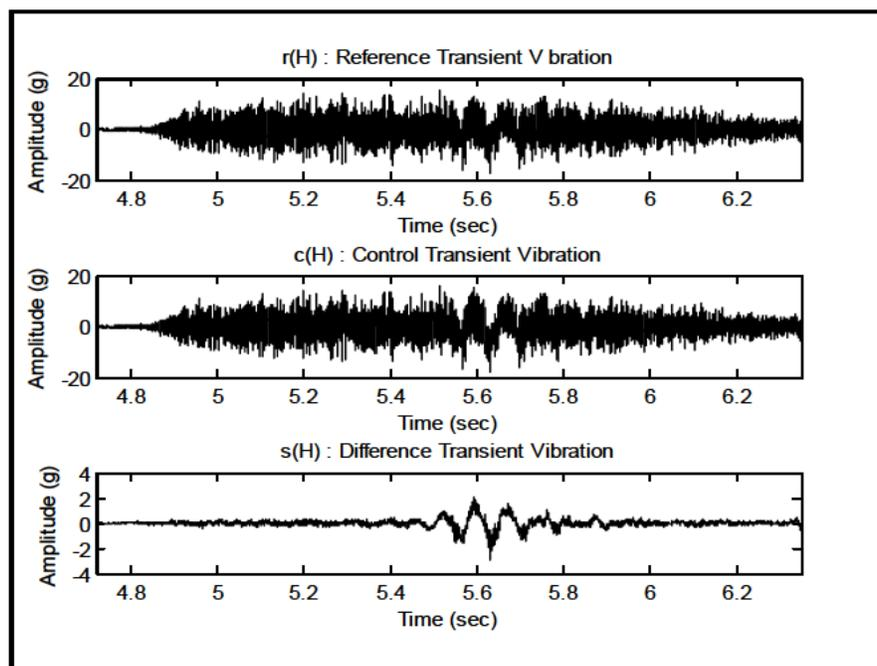


Figure 525.2A-10. Transient vibration time traces - r, c, and s.

The rudimentary overall maximum and minimum statistics for the transient vibration time trace are as follows: r min/max $-17.50/15.41$; c(H) min/max $-18.12/16.11$; and s(H) min/max $-2.99/2.12$.

The replication error is assessed under the product model assumption as follows:

- Plot for r versus c (cross-plot) is generated to measure strength of TPP correlation (particularly for peaks and valleys at extremes of the cross-plot).
- qq-plot for s is generated to examine the difference time trace for normality.
- Root-mean-square envelopes are generated at 0.1 second averaging time for r and c under a product model assumption.
- Normalized ASD estimates are determined for r and c under a product model assumption.

Figure 525.2A-11 plots the amplitude of r versus the amplitude c. Each individual point in the plot represents a point in time with r amplitude along the horizontal axis, and c amplitude along the vertical axis. The spread along the minor axis of this ellipsoidal form implies the difference in r and c at several time increments. In this particular case, the negative peak spread near $-18g$ is nominal, whereas the positive peak spread near $14g$ demonstrates up to a $2g$ difference at given time increments. The spread near $r \approx c \approx 0$ is of little concern since the signal-to-noise ratio is small, and statistically independent Gaussian noise samples are being scatter plotted.

MIL-STD-810H
METHOD 525.2 ANNEX A

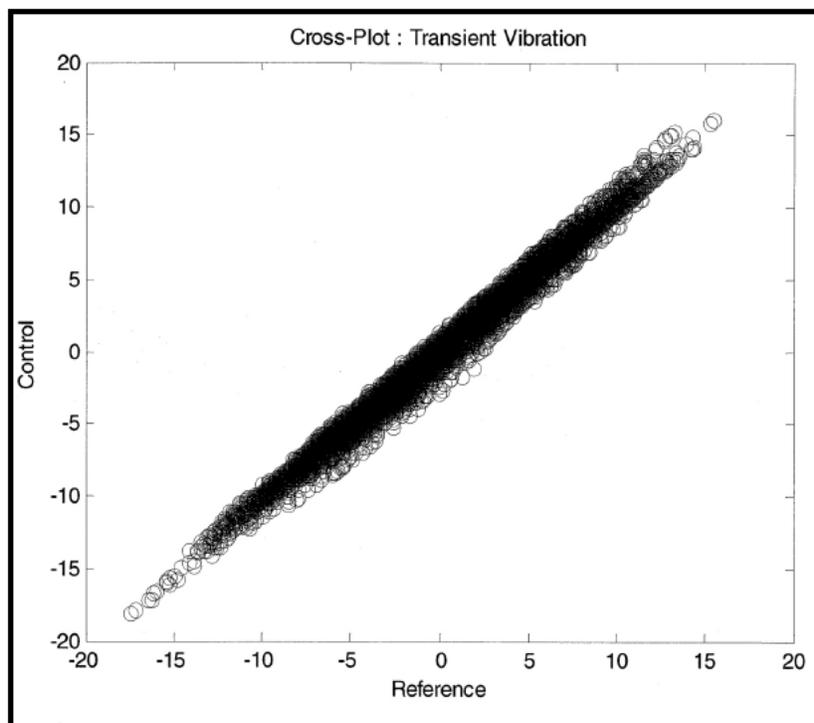


Figure 525.2A-11. r versus c cross-plot.

Figure 525.2A-12 displays the quantiles of s versus the Gaussian distribution. This figure clearly reveals that the difference between r and c is non-Gaussian, and this complicates the replication error assessment. In particular, "s" has tails that are longer than those that might be expected for a Gaussian distribution with a mean and standard deviation estimated from s.

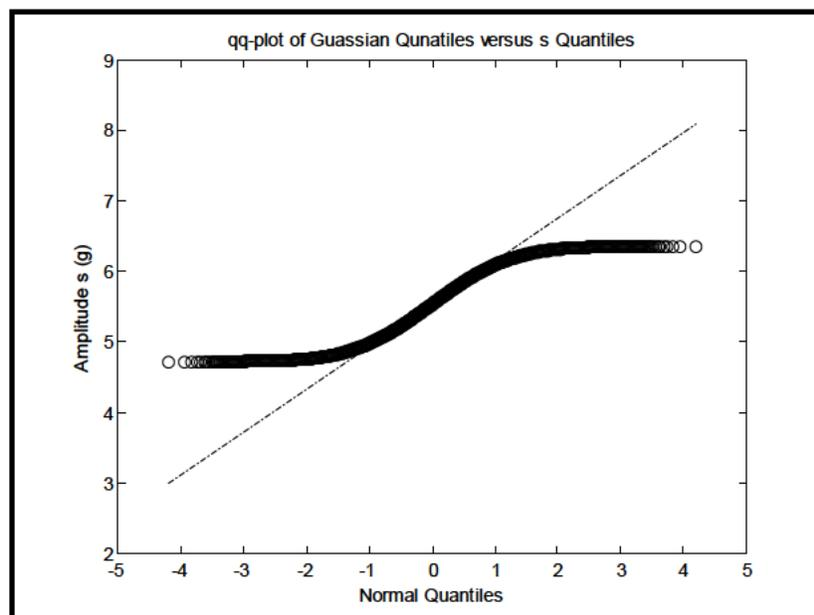


Figure 525.2A-12. Transient vibration q-q plot for s versus Gaussian.

MIL-STD-810H
METHOD 525.2 ANNEX A

Figure 525.2A-13 provides an overlay of envelopes of r and c in terms of root-mean-square g's for a short-time averaging increment of 0.1 seconds (STA assessment). If the product model can be assumed, the differences in root-mean-square envelope levels are a maximum of 2 percent.

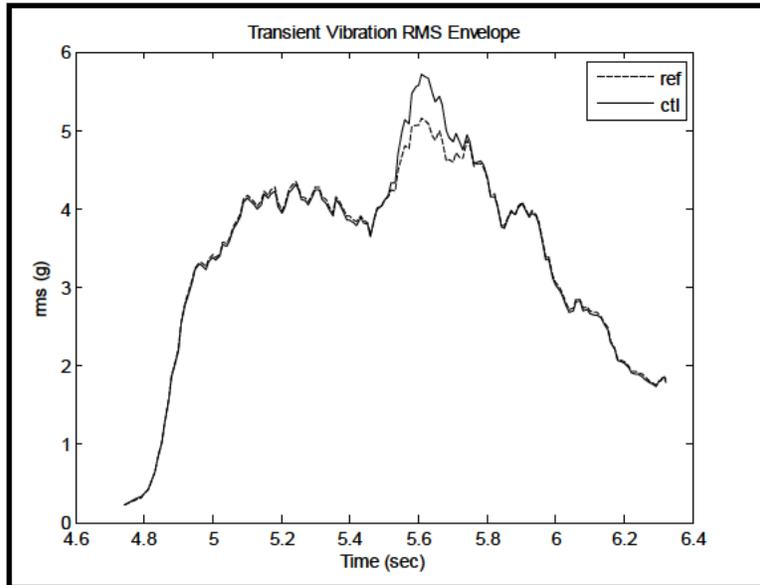


Figure 525.2A-13. Composite root-mean-square envelope estimates for r and c.

Figure 525.2A-14 provides a composite of normalized ASD estimates for r and c. The estimates were determined by one-sixth octave band frequency averaging. The normalized ASD estimates differ by less than 2 dB.

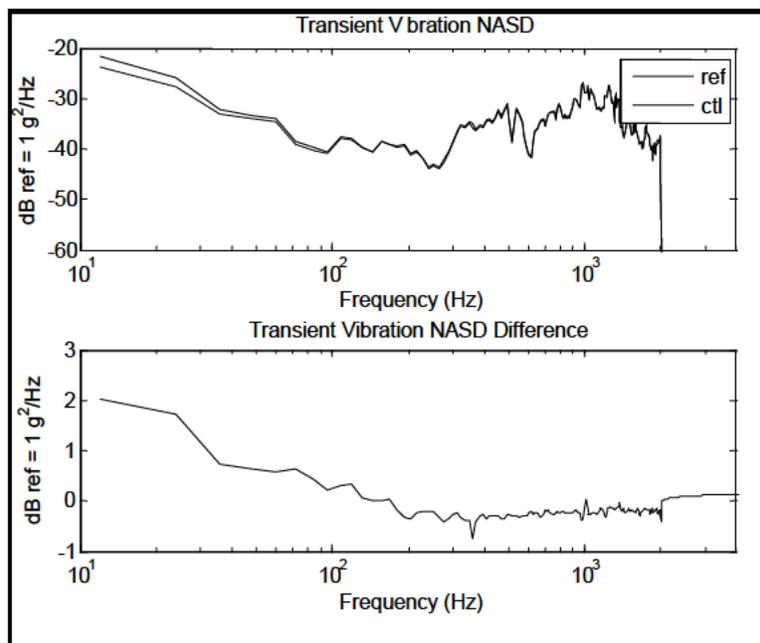


Figure 525.2A-14. Composite normalized ASD estimates for r and c.

From the above statistics, it can be concluded that no valid distinction can be made between r and c under the product model assumption, even though the non-Gaussian distribution of error s is difficult to interpret. It would appear that tolerance for this particular segment could be established as less than 0.2 grms amplitude for 90 percent of the time

MIL-STD-810H
METHOD 525.2 ANNEX A

trace envelope, and 2 dB for the normalized ASD estimates, based on the information in Figures 525.2A-13 and 525.2A-14. This concludes replication error processing and tolerance specification for the transient vibration sub-event.

7. TPP STATIONARY VIBRATION.

Figure 525.2A-15 displays the stationary vibration time traces to be processed for replication error assessment. Note the time trace *s* is nominal, and that *r* and *c* could follow a product model formulation as above because of the comparatively small envelope variation in time.

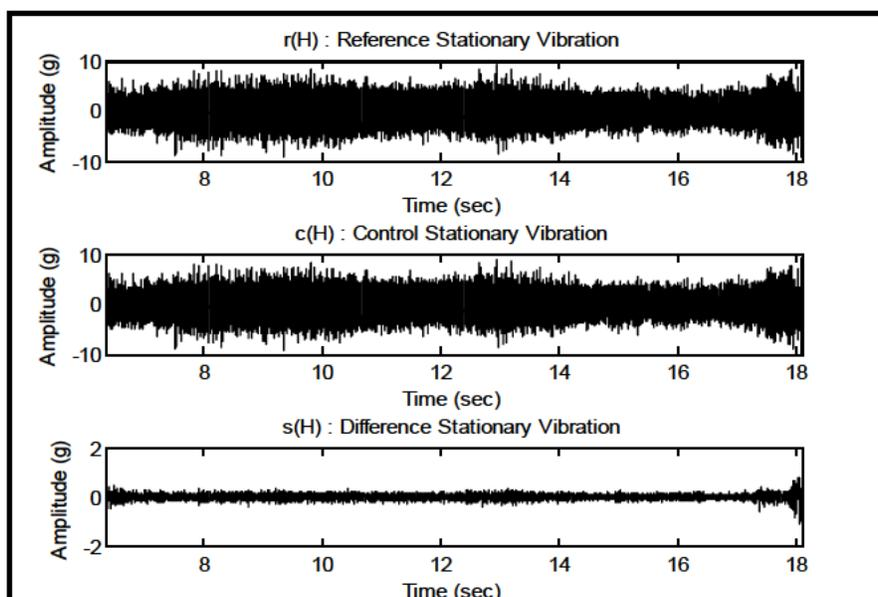


Figure 525.2A-15. Stationary vibration time traces - *r*, *c*, and *s*.

The replication error is assessed under the stationary random vibration assumption as follows:

- (1) Probability density estimates are generated for *r* and *c*.
- (2) *s* qq-plot is generated to examine the difference time trace for normality.
- (3) Fraction-of-Time (FOT) distribution for *s*
- (4) ASD estimates are determined for *r*, *c* and *s*.

To examine the Gaussian form of the stationary vibration trace, the composite histogram (probability density function estimate) for *r* and *c* is plotted in Figure 525.2A-16, with the tail behavior enhanced. The time trace information is long-tailed because of the presence of the time-varying mean-square amplitude. "G" represents the Gaussian histogram on the plot legend.

Figure 525.2A-17 provides a qq-plot for *s* for Gaussian quantiles. The tail behavior of *s* would seem to indicate that the peak and valley values are somewhat larger than and smaller, respectively, than a Gaussian. Even though the Gaussian portion (good fit to straight line is greater than in the transient vibration case).

MIL-STD-810H
METHOD 525.2 ANNEX A

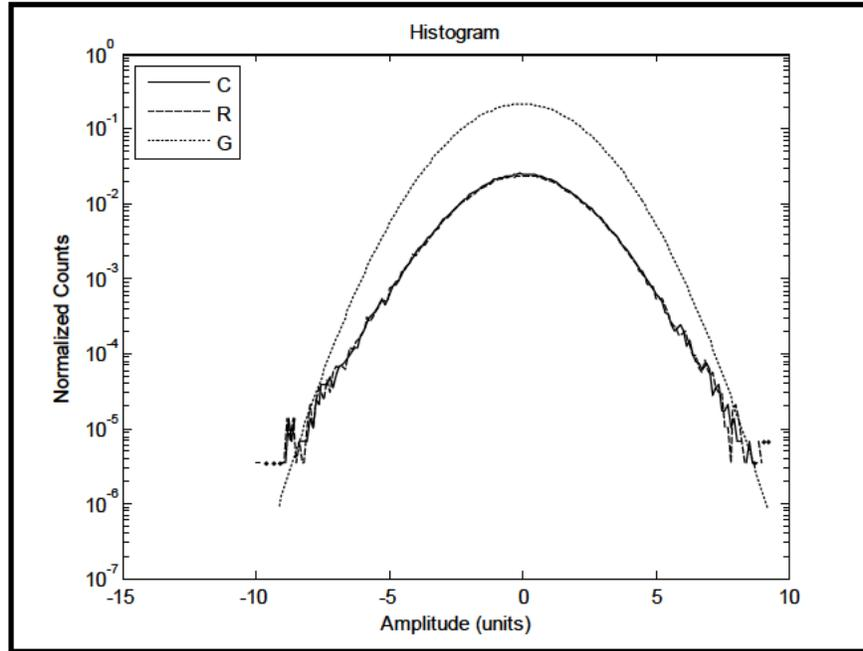


Figure 525.2A-16. Stationary vibration probability density function estimates.

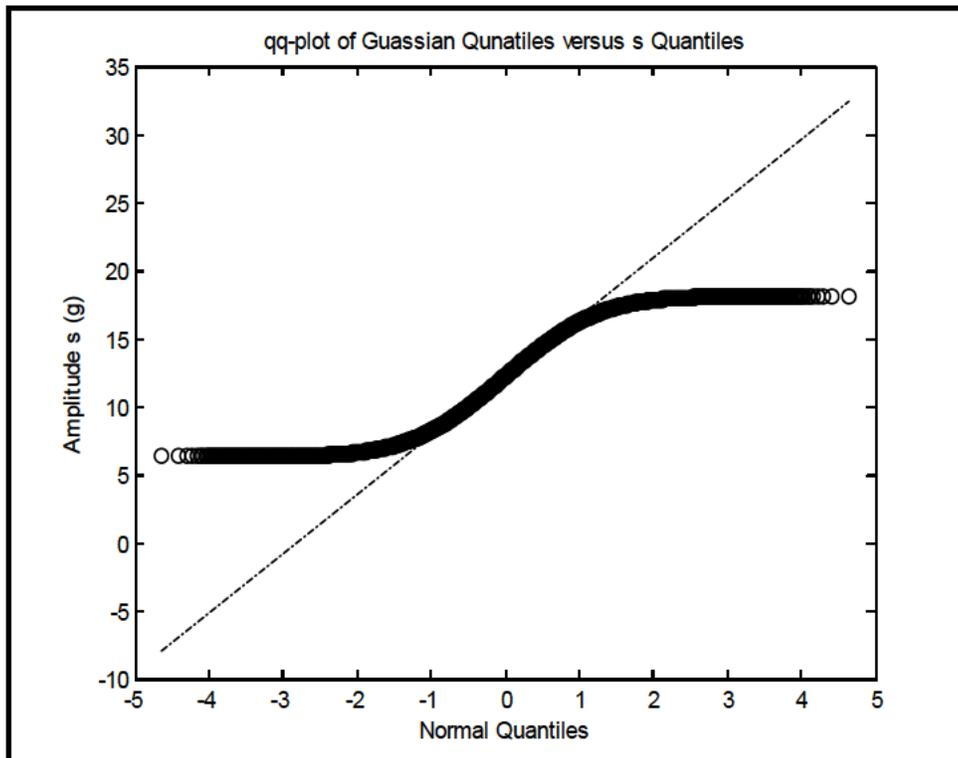


Figure 525.2A-17. Stationary vibration q-q plot for s versus Gaussian.

MIL-STD-810H
METHOD 525.2 ANNEX A

Annex B defines the FOT distribution for difference time trace assessment. This assessment empirically defines the fraction of time the error lies outside (or inside) given error amplitude bounds. This assessment is mathematically equivalent to a probability density (or distribution) assessment but more transparent and easier to interpret for an allowable error tolerance specification. Since TWR is time based, an allowable error of x-percent of the time the error amplitude may exceed y-percent of the root-energy-amplitude level (REA) of the deterministic reference time trace is easily visualized. Figures 525.2A-18a,b,c display the time-varying error in g's for the stationary segment along with the REA percentage error plotted against the FOT quantiles. For the example under consideration the REA for the reference is 1.85 g-rms. Both two-sided and one-sided analyses are considered. The FOT ranges from 0.0 to 1.0 over approximately plus and minus 10% of the REA. Figure 525.2A-18a displays FOT quantiles for 10% to 10% REA error percentage. Figure 525.2A-18b displays the REA random error -5% to 5% for FOT quantiles from approximately 0.1 to 0.9 and Figure 525.2A-18c considers one-sided error for 10% REA error percentage and the 0.90 FOT quantile. A two-sided tolerance specification might, for example, require not more than 10% (0.10 FOT quantile) of test time to lie outside the REA amplitude percentage bounds of -5% and 5%. Tolerance is in terms of what percentage of time is the error allowed to be larger than a certain percentage of REA as a reference amplitude.

In Figure 525.2A-19, a composite of the ASD estimates for r and c is provided. The ASD estimates between r and c are essentially equivalent. For time trace s, there is non-flat spectrum that normally would not be present if the replication error were of a strong Gaussian character, i.e., s was band-limited white noise. The processing parameters are an analysis bandwidth of 5 Hz applying a Hamming window with 50 percent overlap.

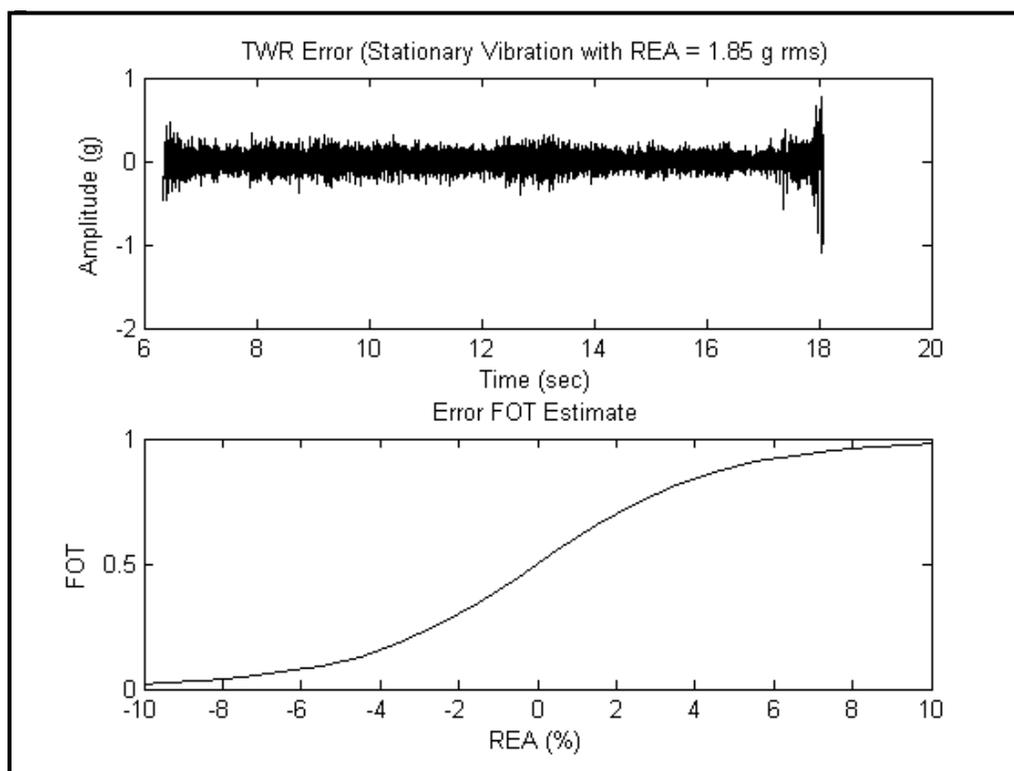


Figure 525.2A-18a. FOT Error Assessment – 10% REA Error Fraction-of-Time (FOT)

MIL-STD-810H
METHOD 525.2 ANNEX A

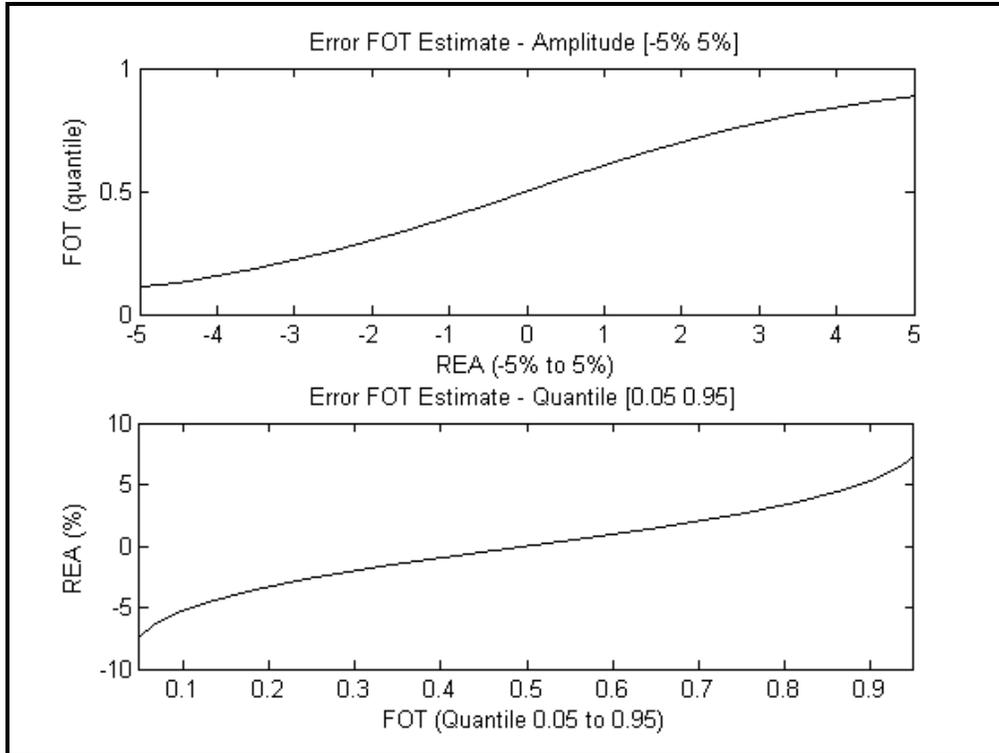


Figure 525.2A-18b FOT Error Assessment - 5% REA FOT Error Bounds

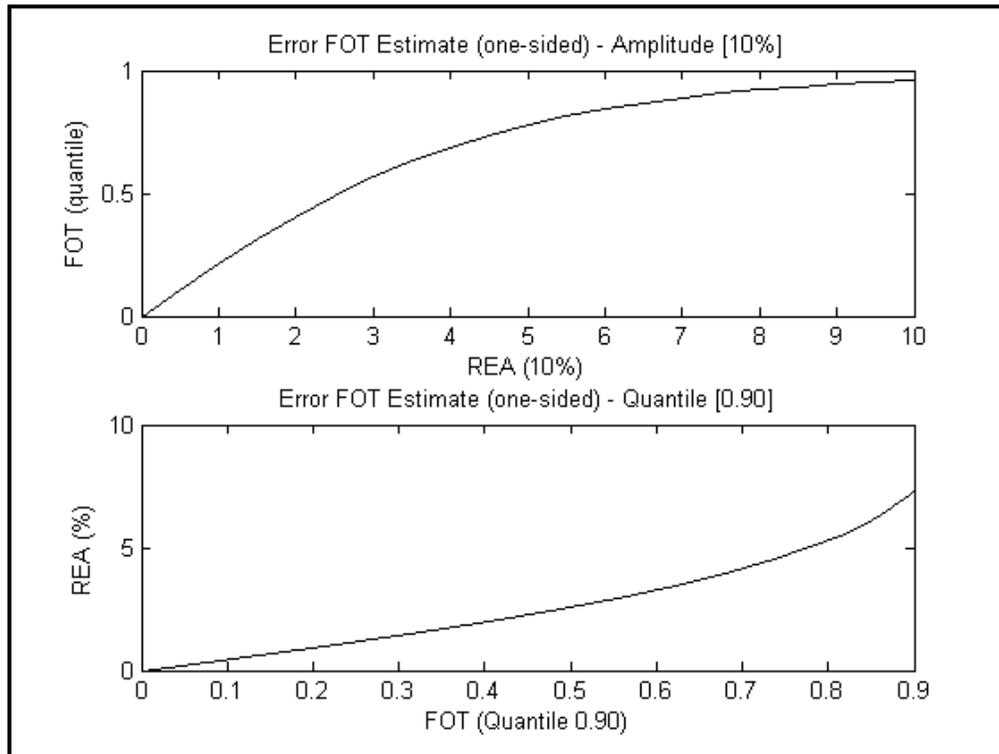


Figure 525.2A-18c FOT Error Assessment - One-sided 10% REA FOT Error Bounds

MIL-STD-810H
METHOD 525.2 ANNEX A

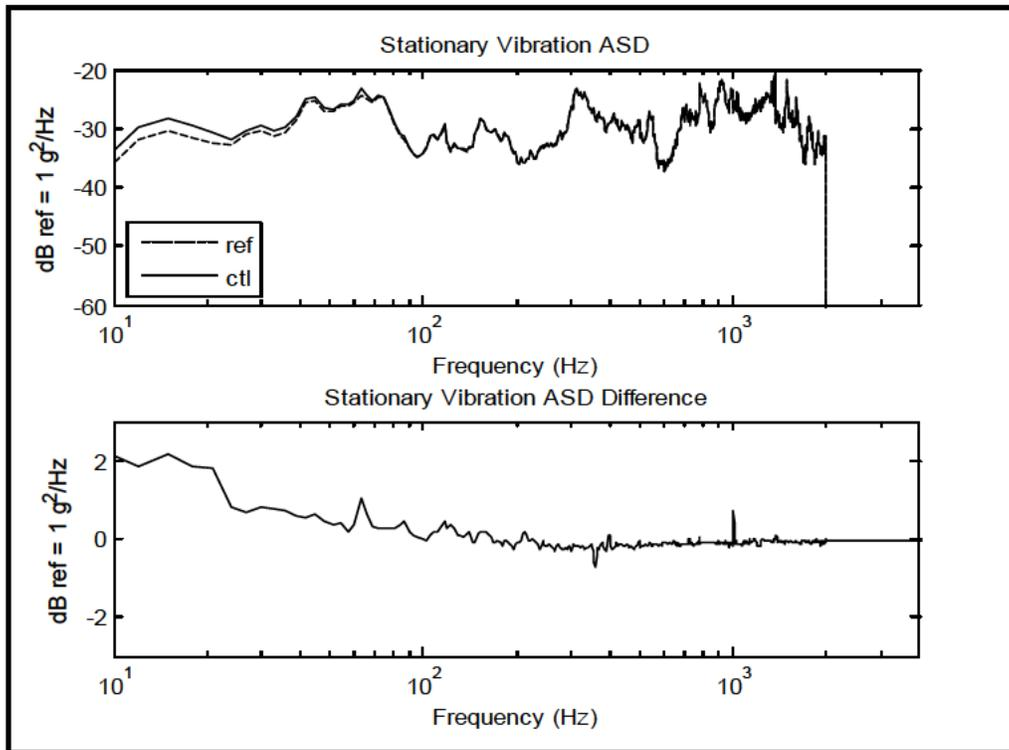


Figure 525.2A-19a. Composite ASD estimates for r and c.

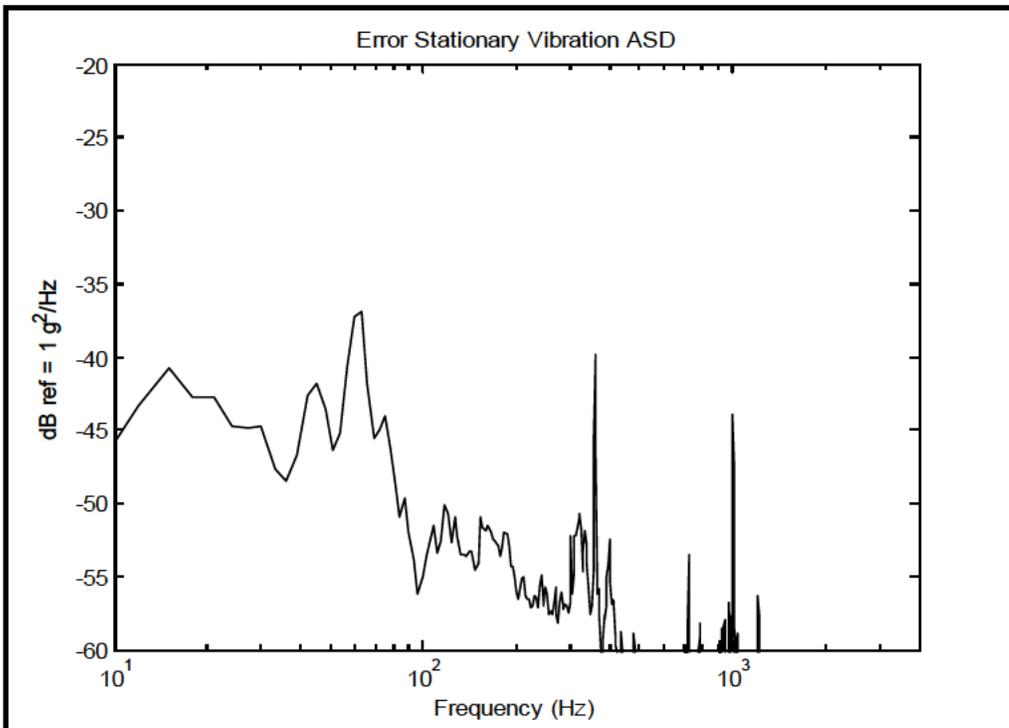


Figure 525.2A-19b. ASD estimate for s.

From the above statistics, it might be concluded that no valid distinction can be made between r and c under the stationary model assumption even though the non-Gaussian distribution of error s is difficult to interpret. It would

MIL-STD-810H
METHOD 525.2 ANNEX A

appear that tolerances for this particular segment could be established as maximum 2 dB for the ASD estimates, based on the information in Figure 525.2A-19. This concludes replication error processing and tolerance development for the stationary vibration sub-event.

8. TPP SHOCK.

Figure 525.2A-20 displays the shock time traces that will be processed for replication error assessment. Note that time trace, s, is not nominal in the area of maximum shock. The maximum/minimum values for each trace are given by r: -22.84/35.24; c(H): -24.28/39.76; and s(H): -4.11/4.78.

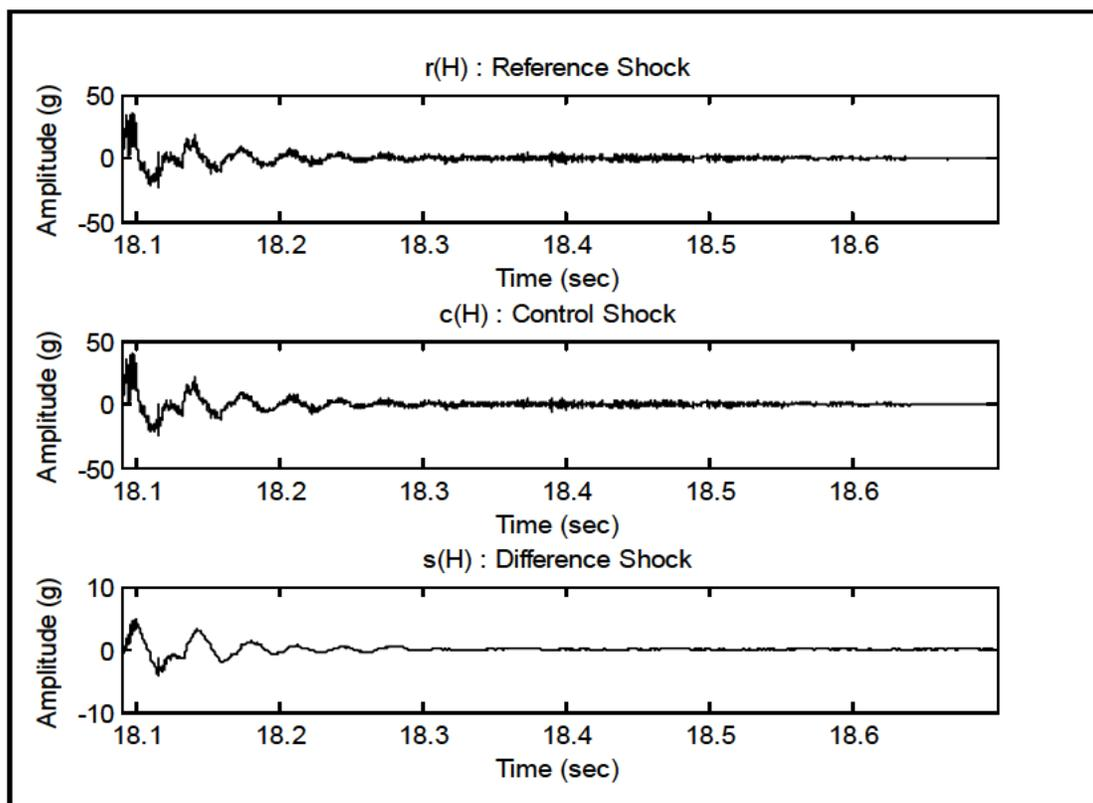


Figure 525.2A-20. Shock time traces - r, c, and s.

The replication error is assessed under the shock assumption as follows:

- a. An r versus c cross plot is generated.
- b. s qq-plot is generated to examine the difference time trace for normality.
 - (1) Pseudo-velocity SRS assessment for r and c.
 - (2) ESD estimates are determined for r, c, and s under a shock time trace assumption.

For the shock segment, a cross plot of r versus c provides useful information with regard to the positive and negative peaks. However, from the form of the r and c time traces, it is obvious that histograms and empirical q-q plots versus the Gaussian will yield little useful information. Figure 525.2A-21 provides a cross-plot of r versus c.

MIL-STD-810H
METHOD 525.2 ANNEX A

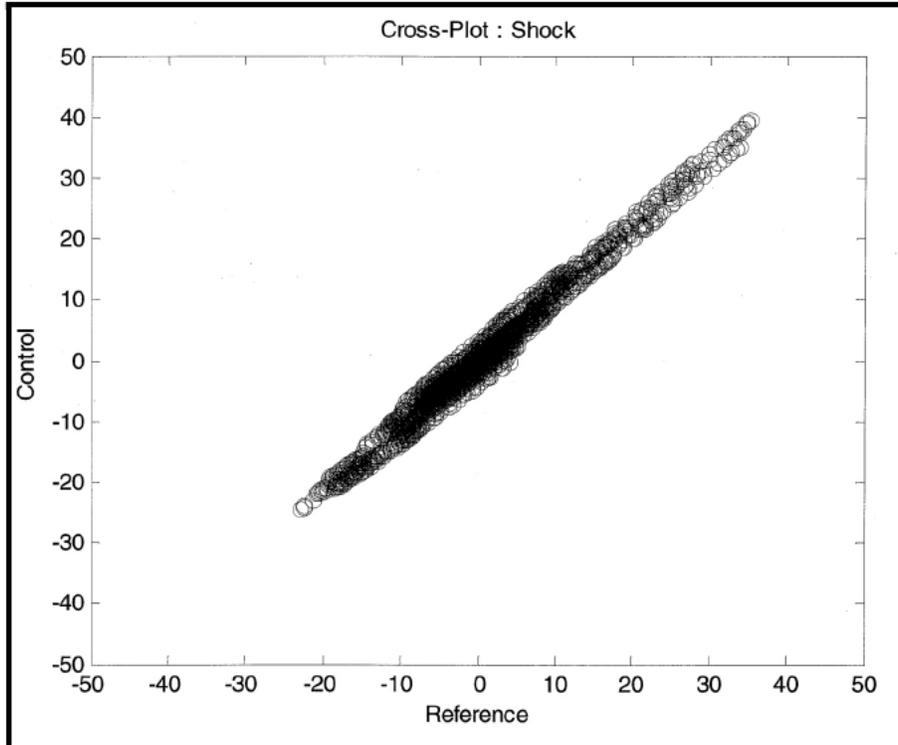


Figure 525.2A-21. r versus c cross-plot.

Even though “s” will not display Gaussian character, some indication of its non-Gaussian character can be useful. Figure 525.2A-22 provides a q-q plot of s versus the Gaussian distribution. Clearly, the sample quantiles from “s” in the tails far exceed any Gaussian model that can be fit to s.

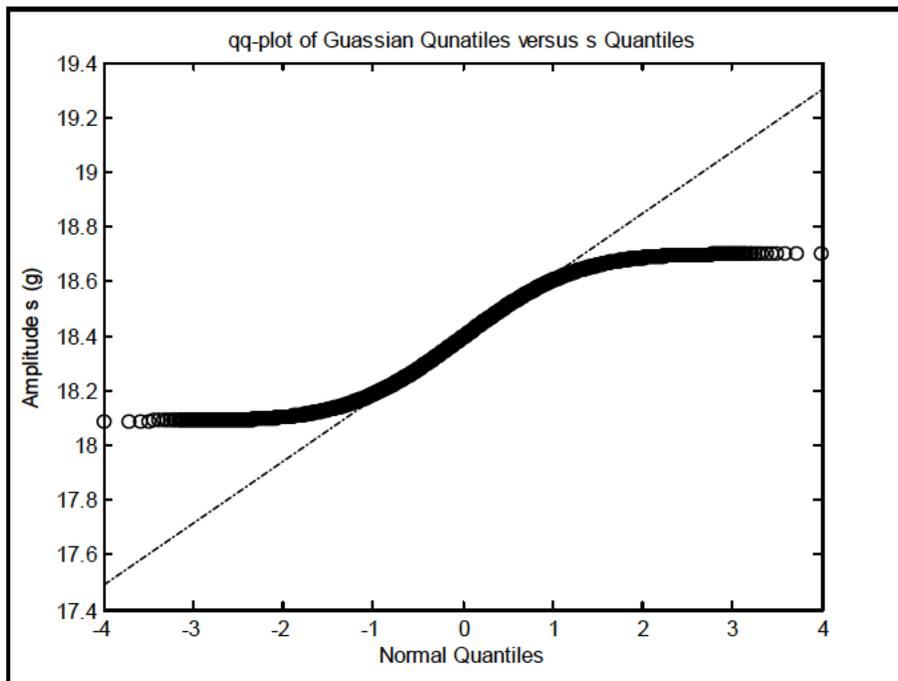


Figure 525.2A-22. Shock q-q plot for s versus Gaussian.

MIL-STD-810H
METHOD 525.2 ANNEX A

A common way of comparing shock information is through the SRS, in particular the recommended pseudo-velocity SRS estimate (Method 516.8). For the r and c time traces, a composite overlay of the pseudo-velocity SRS estimates for both shocks is useful. Figure 525.2A-23 provides this comparison in addition to a maximax acceleration SRS comparison. Since the SRS is an integration/smoothing process, it is expected that the reference and control information will be highly correlated when viewed in an SRS format. For these figures no wavelet correction was attempted for low frequency correction since such a correction applied individually may lead to a less transparent comparison.

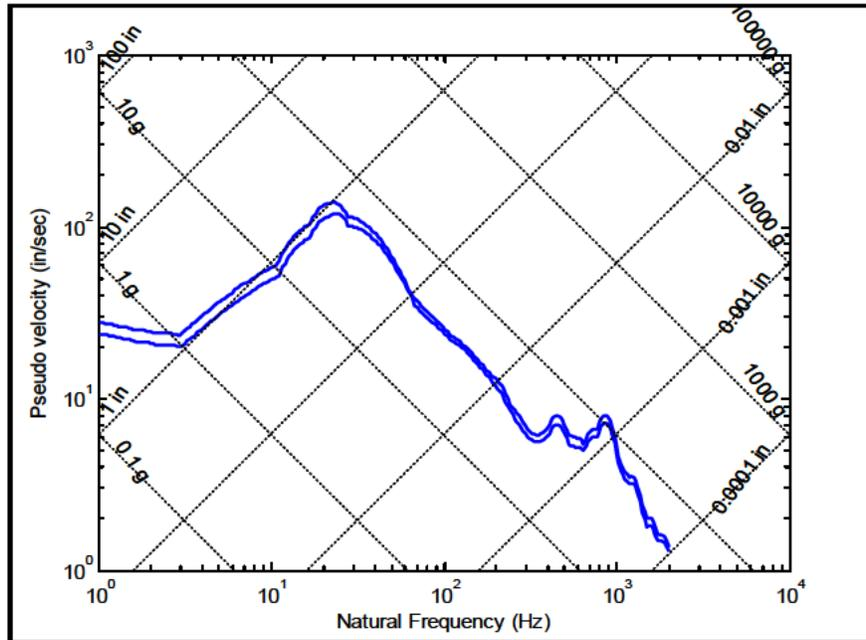


Figure 525.2A-23a Composite pseudo-velocity maximax pseudo-velocity SRS for r and c.

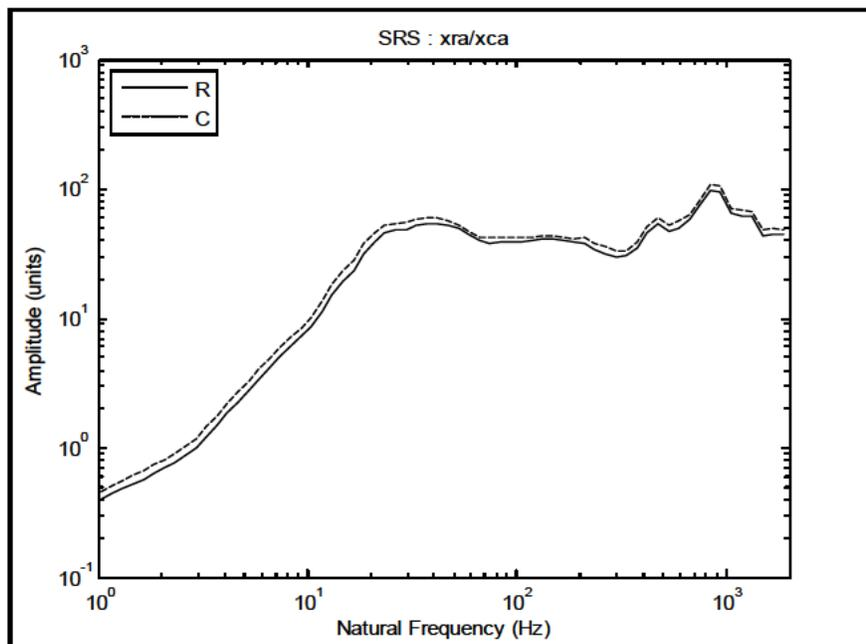


Figure 525.2A-23b. Composite maximax acceleration SRS for r and c.

MIL-STD-810H
METHOD 525.2 ANNEX A

Since ESD estimates provide a way of comparing shock type events, Figure 525.2A-24 provides a composite of r and c ESD estimates, while Figure 525.2A-25 provides the ESD estimate for "s." It is clear from both of these plots that the most substantial error is found in the low frequency region. This is not surprising since the transfer function used to compensate the entire time trace was likely not optimal for the shock.

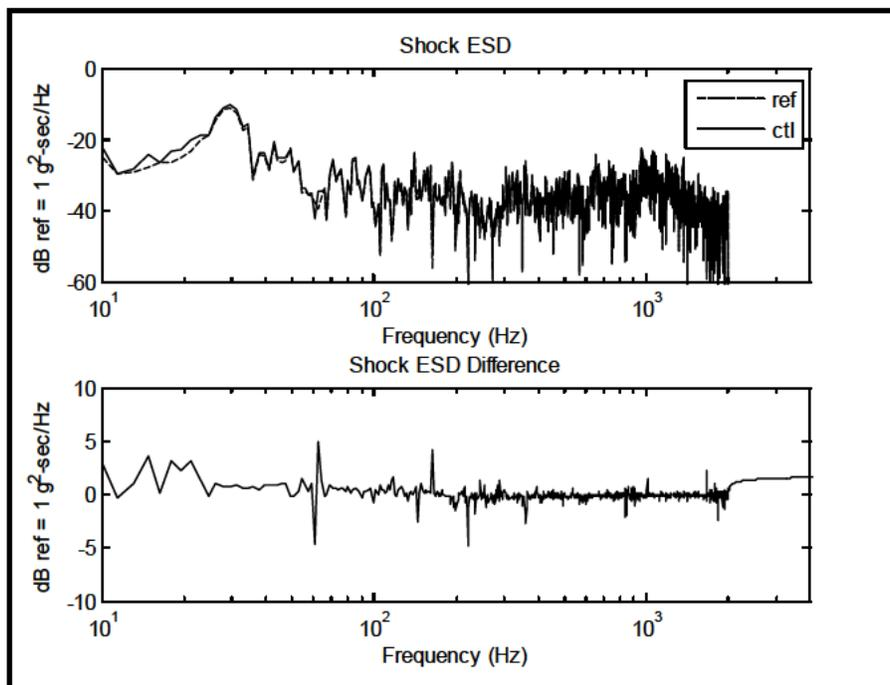


Figure 525.2A-24. ESD estimates for r and c.

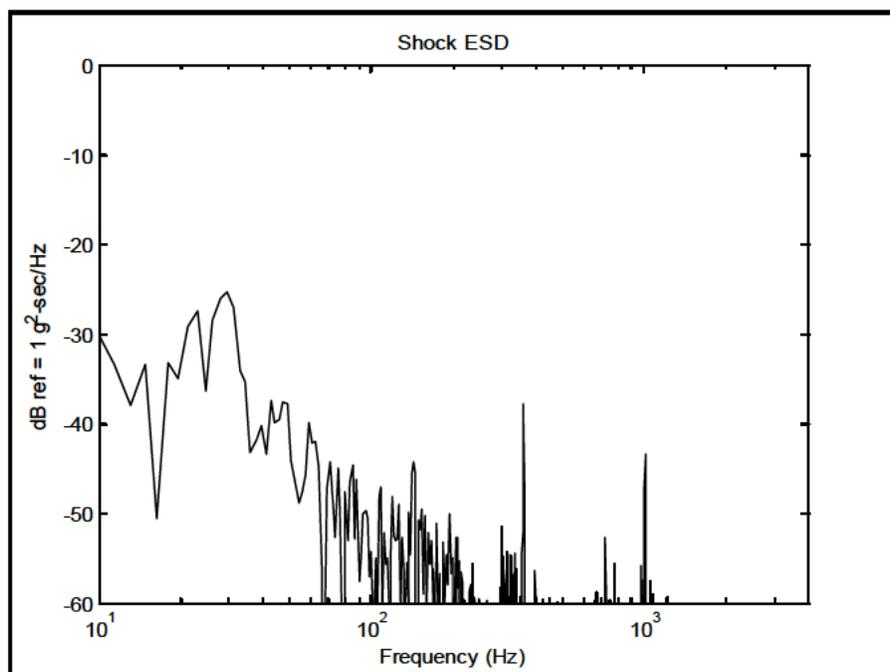


Figure 525.2A-25. ESD estimate for s.

MIL-STD-810H
METHOD 525.2 ANNEX A**9. POST-TEST PROCESSING FOR STA.**

TPP replication error assessment is most stringent for specifying tolerance criteria being that the tolerance criteria must be satisfied for the correlated time points, point-by-point. Replication error averages for STA is most easily defined for application to s , as opposed to application to r and c individually, and then seeking to compare STA r estimates with STA c estimates. Annex B discusses some complications with individual STA application. For Annex A post-test processing, using STA directly centers upon the statistical characteristics of s under short-time averaging. Figures 525.2A-26 and 525.2A-27 display short-time averaging for the mean and root-mean-square of time trace s over the entire time trace displayed in Figure 525.2A-3d-f for 0.05 and 0.20 second averaging times. An averaging time of 0.05 seconds for a bandwidth of 2000 Hz provides 5 percent normalized random error in the root-mean-square estimate, and an averaging time of 0.20 seconds for the SESA bandwidth provides a 5 percent normalized random error in the mean-square estimate. For AC coupled instrumentation measurements, the short-time average mean is near zero - not particularly meaningful, but is computed for completeness. It is clear from these figures that the rate of change of the time trace is too great in the transient vibration, and shock tails of the time trace to provide meaningful estimates by averaging in time. Thus, tolerance information in these two tails requires another basis, e.g., TPP.

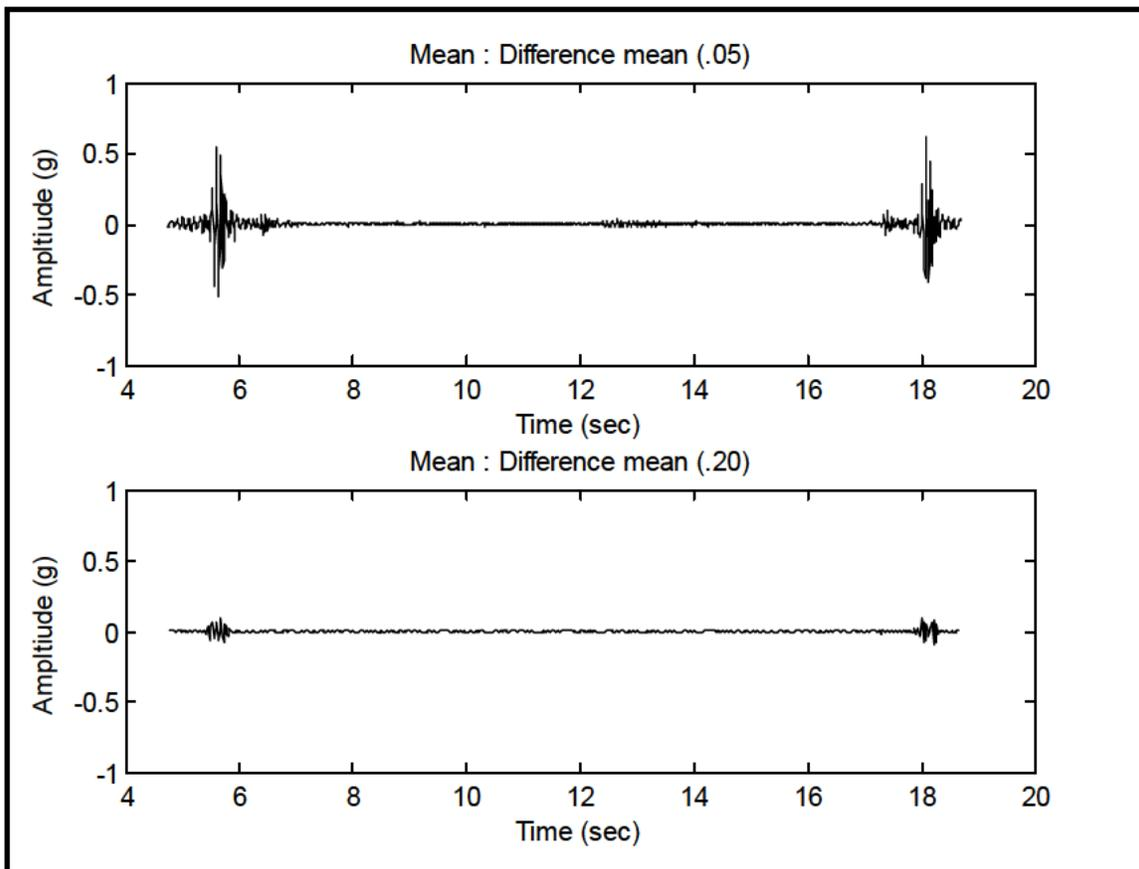


Figure 525.2A-26. Short-time averaging for difference mean.

MIL-STD-810H
METHOD 525.2 ANNEX A

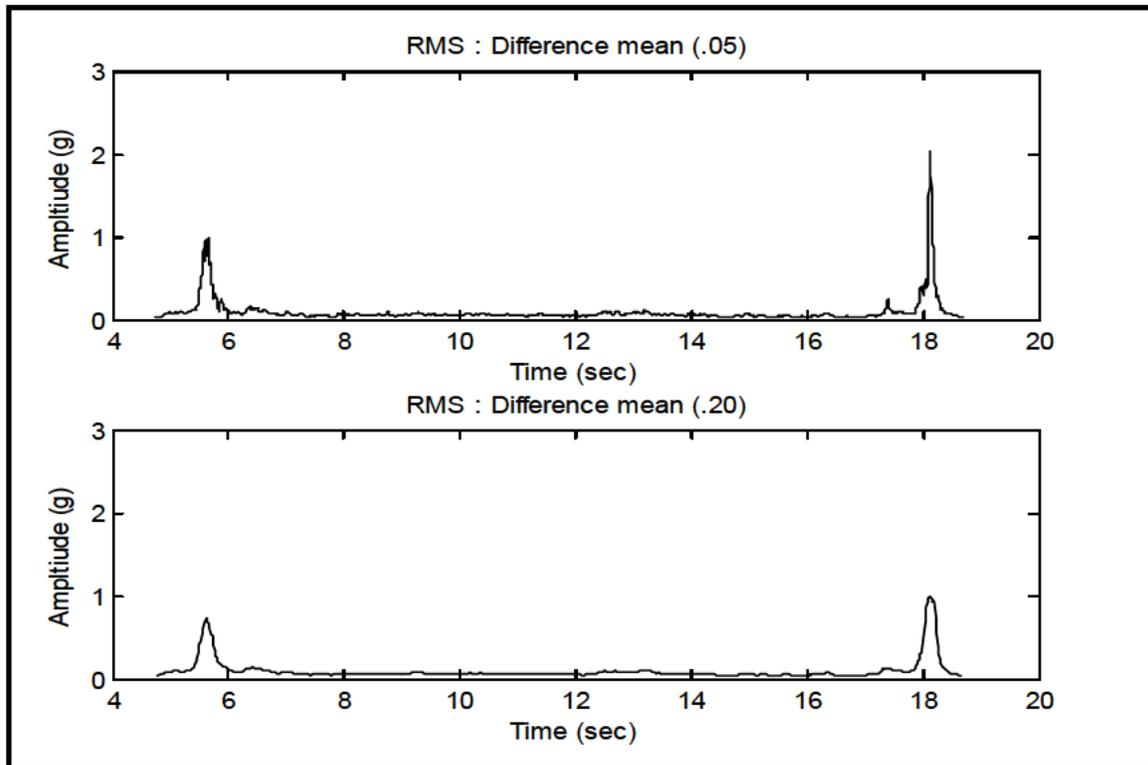


Figure 525.2A-27. Short-time averaging for difference root-mean-square.

Justification for using short-time average estimates for error assessment is that for stationary random processing, the principal comparison with the ASD estimate in the frequency domain is an average, and for shock processing, the principal comparison with the SRS estimate in the single-degree of freedom natural frequency domain is an integrated (or averaged) nonlinear type estimate. Annex B defines time average estimates in continuous form, and in digital form for a rudimentary description of the underlying non-stationary random process. The averaging time is arbitrary, but generally will be such that the normalized bias error is a minimum, and the normalized statistical error in the root-mean-square estimate under Gaussian assumptions is no more than 0.05. The expressions for the normalized root-mean-square error and normalized mean-square error are provided in Annex B.

This concludes Annex A and processing of selected information supplied for SESA TWR. As technology evolves, the information in this Annex will also evolve. Significant evolution needs to take place in understanding the extent of signal compensation, how it is performed, what its limitations are, and just general overall TWR control strategy understanding. This evolution will feed directly into the development of realistic tolerance limits based upon replication error assessment.

MIL-STD-810H
METHOD 525.2 ANNEX A

(This page is intentionally blank.)

MIL-STD-810H
METHOD 525.2 ANNEX B

METHOD 525.2, ANNEX B
SUMMARY OF POST-TEST ANALYSIS PROCESSING PROCEDURES AND TEST TOLERANCE SPECIFICATION

1. INTRODUCTION.

The purpose of this Annex is to provide an informational basis for establishing tolerance assessment for single-exciter/single-axis (SESA) time waveform replication (TWR) laboratory tests independent of the vendor software. This Annex does not recommend any single methodology for TWR error assessment and is somewhat incomplete in that the statistical analysis of reference/control scatter plots is not discussed in detail. Correct understanding of reference/control scatter plots, perhaps in linear regression terms, and the accompanying statistics would seem to lie at the heart of TWR test tolerance assessment. In paragraph 4 of this Annex a test tolerance rationale is provided. In the future, vendors may incorporate such tolerance assessment options for the convenience of the test laboratory and determination if test specifications are satisfied. For now test tolerance assessment relative to a specification beyond the vendor software will require a trained analyst and off-line processing of digital sequences through custom software, e.g., MATLAB, LABVIEW, etc. Paragraph 2 provides standard terminology for SESA TWR. The formulas in paragraph 3 may assist in the design of custom software. This Annex does not summarize vendor assessment for replication error. In general, a vendor provides an estimate of the comparison between the reference and control time traces based upon time averaging over a specified time history segment. This time averaging generally takes no account of the form of the time trace, is performed in order to assess error as the test progresses in time (probably for control issues), and provides a rationale for aborting the test if the error exceeds certain prescribed limits. However, since vendor software is fundamental to test control this blocksize should be noted and considered the maximum block size to be used in post-processing error assessment under short-time-averaging (STA).

This Annex assumes that the “reference” time trace is band limited and of a deterministic in nature even though it may be a sample time trace from a field measured random process. This Annex assumes that the “control” time trace is stochastic in nature. This defines a SESA model whereby a deterministic time trace is input to a “random system” that provides a stochastic output. The randomness of the system comes from all the unquantified details of the reproduction of the deterministic input time trace including boundary conditions, compensation, system noise etc. The distinction between a “deterministic” and a “stochastic” reference time trace is subtle. The easiest way to visualize this distinction is to think in terms of a regression model for which there is an independent variable selected ahead of time and a dependent variable that reflects a dependence upon the value of the independent variable. In data analysis when both variables are associated the relationship between them is a “structural” relationship as opposed to a “regression” relationship since both variables in the “structural” relationship are subject to estimation and random error. A second subtle feature of the processing is that a “statistical basis” as opposed to a “probabilistic basis” is assumed. The statistical basis allows for “time averages” as opposed to requiring “ensemble averages” for a probabilistic basis. This seems natural since seldom is it useful to consider SESA TWR reference and control time traces in terms of ensembles.

In description of the assessment to follow, this Annex assumes that the bandwidth for comparison i.e., error between the reference trace, $r(t)$, and the control time trace, $c(t)$, is comparable. It is important that the test personnel understand clearly the bandwidth of all time traces from field measurement, unprocessed control time trace and the error time trace, $s(t)$, defined below. See Annex A paragraph 4.2 for a more detailed discussion of time trace band limit considerations.

2. TERMINOLOGY.

In this Annex *replication error assessment* or equivalently *test tolerance assessment* refers to examining the properties of the difference (as a function of time) between the TWR “input” and the TWR “output”. TWR “*test specification*” refers to using the results of the error assessment to determine if the laboratory TWR test replicated the “input” satisfactorily i.e., if “*test tolerances*” common to other Methods are satisfied for TWR. For Method 525 there are potentially five categories related to test specification.

In this paragraph, the continuous analog time traces are represented by lower case letter as a function of time, t . The upper case associated letters represent the random variables obtained by sampling the properly signal conditioned analog time traces. The TWR reference time trace, $r(t)$, is considered to be band limited and deterministic in nature. It is specified in an ASCII file with required oversampling for replication. The TWR control time trace, $c(t)$, is stochastic as a function of the test configuration including compensation strategy and system noise. The difference

MIL-STD-810H
METHOD 525.2 ANNEX B

between the control and reference time traces, $s(t)$, is stochastic in nature and is the primary time trace to be used in the TWR error assessment and tolerance specification.

For R deterministic and S and C stochastic variables and a physical correspondence between $r(t)$ and $c(t)$, i.e., $c(t)$ output resulting from TWR then define

$$(1) R \text{ associated with } r(t) \text{ as } R = \{r[n], n = 1, 2, \dots, N\}$$

$$(2) C \text{ associated with } c(t) \text{ as } C = \{c[n], n = 1, 2, \dots, N\} \text{ and}$$

$$(3) S \text{ associated with } s(t) = c(t) - r(t) \text{ as } S = \{s[n] = c[n] - r[n], n = 1, 2, 3, \dots, N\}$$

If the two continuous time traces $r(t)$ and $c(t)$ are identical according to “time-point by time-point” (TPP), then the time trace represented by the reference time trace has been replicated exactly in the laboratory. Generally the reference and control time traces are not TPP identical and “statistics” must be introduced to quantify $s(t)$. Stochastic S has no preconceived theoretical probability distribution function (in fact $s(t)$ or S provides an “optimum” estimate for error assessment in the sense that the statistics of gross averages are of lesser importance in error assessment. As has been demonstrated in Annex A, S is generally neither Gaussian distributed nor stationary. Once S has been determined and parameters of R known, R and C will play a lesser role for tolerance assessment except for Category III and Category IV specification in paragraph 4.

3. REPLICATION ERROR (TEST TOLERANCE) ASSESSMENT EXPRESSIONS.

For replication error assessment, it may be useful to *nonuniformly* time weight or “window” $s(t)$ over a time interval before making error estimates but the rationale for such weighting is beyond the scope of discussion here. For the replication error assessment to follow, two options are available:

- (1) examining the statistical properties of sequence S directly in an overall or “global” sense
- (2) examining sequence S under “short-time averaging” (STA) yielding stochastic variable S_A for statistical assessment where S_A represents a “local” average and the total set of “local” averages summarizes S

The stochastic estimates S_A have bias error and random error, but it is assumed that judicious selection of the “window” has representative random error and minimum bias error.

The time averaging procedure can be applied to *functions of* $s(t)$ such as the instantaneous mean-square level of $s(t)$, i.e., $s^2(t)$. In using STA for replication error assessment, the summary statistics need to be clearly defined, and any note made of dependence introduced in the averaging process e.g., serial correlation of shifted average values.

Since it is assumed that for $E\{\}$ the expectation operator on stochastic variables and $S = C - R$, then

$$E\{S\} = E\{C - R\} = E\{C\} - R. E\{S_A\} = E\{\bar{S}\} = E\{\overline{(C - R)}\} \approx E\{\bar{C} - \bar{R}\} = E\{\bar{C}\} - \bar{R} = E\{\bar{C}\} - R_A = C_A - R_A.$$

Replication error assessment precedes TWR tolerance specification, however replication error assessment must relate directly to tolerance specification. For example, tolerance specification for TWR is not viable for “single point” error assessment i.e., maximum of S but maximum of S may be a meaningful parameter. In addition the deterministic reference, R , is generally oversampled by a factor of ten or more based upon TWR requirements. It is safe to assume that a “nominal window” for error assessment could be a uniform time interval with the number of points equal the oversample factor. This implies that “smoothed” error estimates applied to sequence S are fundamental in replication error assessment and subsequent tolerance specification. As noted above generally the smoothing window should not exceed the vendor control blocksize. The oversample factor and this blocksize provide bounds on STA averaging time selection.

In the expressions to follow, processing will take place over a uniform time interval $T = [T_{i+1} - T_i]$. Formulas provided will be expressed in a continuous form followed by a discrete digital form. In general, the error statistics for the estimators will be provided for the ideal case in which $s(t)$ is bandwidth limited white noise of bandwidth B . The role the error statistics for the estimators play is to insure that artificial estimation errors in replication error assessment are minimal when compared to the replication errors to be used in tolerance specification. As mentioned above, seldom is the character of $s(t)$ so simple, so that the processing error statistics are approximate for other than bandwidth limited white noise. Normalized random errors are provided for most estimates. Bias error occurs whenever averaging takes

MIL-STD-810H
METHOD 525.2 ANNEX B

place, however for averaging windows on the order of the oversample factor bias error should be minimal. Whenever practical bias errors in the estimates for the error assessment need to be minimized. If there exists questions relative to the size of normalized bias and random errors, much more detailed processing beyond the scope of this Annex may need to be employed (paragraph 6.1, reference a).

In description of the error assessment expressions, the designation “local” or “global” is made. The term “local” refers to a statistic that is useful for processing short segments of time-varying traces, while the term “global” refers to a statistic that is better suited to summarizing overall time traces. For example, the collection of STA for S root-mean-square provides “local” estimates related to a potential tolerance specification. The cumulative probability density function estimate for S describes error as being perhaps Gaussian or non-Gaussian. This is a “global” assessment from which a tolerance specification might be based upon the distributional form of the estimate. Generic variables

$$x(t) \left(x[n], n = 1, 2, \dots, N \right), y(t) \left(y[n], n = 1, 2, \dots, N \right) \text{ and } z(t) \left(z[n], n = 1, 2, \dots, N \right)$$

are employed in the formulas whereby $r(t)$, $c(t)$, and $s(t)$ may be substituted at will depending upon interpretation. In the formulas to follow M will be an “index” related to the time sample interval for the time average estimate (it is a time shift parameter for averaging) and N_a will be the number of time points averaged over. $\lfloor N_a/2 \rfloor$ is the greatest integer designation for $N_a/2$. It is assumed that $M = \lfloor N_a/2 \rfloor + \lfloor N_a/2 \rfloor - 1$ where generally M is an odd number to prevent any phase shift introduced in the processing.

There are three cases in which joint consideration of deterministic R and stochastic C may be useful. In the first case a scatterplot constructed by plotting the point $(r(n), c(n))$ in the plane will reveal valuable information relative to a single plot of the error $s(n)$. In the second case since computation of an ASD/ESD estimate over a deterministic time trace has some meaning the comparison of the ASD/ESD estimates for $r(n)$ and $c(n)$ may provide meaningful information in relation to the ASD/ESD for $s(n)$. In particular the deterministic estimate is divided into the stochastic estimate to examine the ratio in the frequency domain. Finally, comparison of SRS estimates for $r(n)$ versus $c(n)$ along with an SRS estimate for $s(n)$ i.e., the “noise” can be useful.

For easy reference the following table is provided:

Table B-I. Summary of error assessment expressions

E1	MEAN (local & global) S
E2	ROOT-MEAN-SQUARE & MEAN-SQUARE (local & global) S
E3	COVARIANCE, CORRELATION and SCATTER-PLOT (global) R and C
E4	PROBABILITY DENSITY, CUMULATIVE PROBABILITY and QUANTILE (global) S
E5	FRACTION-OF-TIME (global) S
E6	ASD/ESD/PERIODOGRAM (global) R and C
E7	SHOCK RESPONSE SPECTRA (global) R and C

Expressions E1 through E7 are potentially useful for TWR tolerance specification. Future editions of MIL-STD-810 will likely refine and add to these expressions as SESA TWR testing becomes more common and experience with both replication error assessment and subsequent test specification becomes more common. Generally E1, E2, E5, E6, and E7 will directly relate to tolerance specification. E3 and E4 provide good qualitative information but will not directly relate to tolerance specification.

MIL-STD-810H
METHOD 525.2 ANNEX B

E1: MEAN (local & global)

A collection of STA for $s(n)$ provides an indication of any potential “shift” in very low frequency information contained in $r(t)$ under TWR. A zero mean error is desirable otherwise bias may be present. The mean estimate for $x(t)$ is defined as follows:

$$\hat{\mu}_x(t_i) = \int_{T_{i-1}}^{T_i} x(t) dt \leftrightarrow \hat{m}_{x_i} = \frac{1}{N_a} \sum_{i=M-\lfloor N_a/2 \rfloor+1}^{M+\lfloor N_a/2 \rfloor} x(t_i) \quad (1)$$

The normalized random error in the mean estimate in units of root-mean-square is defined as

$$\varepsilon[\hat{\mu}_x] \approx \frac{1}{\sqrt{2BT}} \left(\frac{\sigma_x}{\mu_x} \right) \text{ for } \mu_x \neq 0, B, \text{ overall bandwidth of } x(t), \text{ and } T, \text{ averaging time.} \quad (2)$$

Note that this is related to the confidence interval with confidence coefficient $1 - \alpha$

on the mean of a population (not necessarily a time history) obtained by a sample of size N i.e.,

$$CI_{\mu_x, 1-\alpha} = \left[\bar{x} - \frac{\sigma_x z_{\alpha/2}}{\sqrt{N}} \leq \mu_x \leq \bar{x} + \frac{\sigma_x z_{\alpha/2}}{\sqrt{N}} \right].$$

E2: ROOT-MEAN-SQUARE and MEAN-SQUARE (local & global)

A collection of STA root-mean-square levels in time is fundamental for replication error assessment and probably is closely aligned with vendor TWR error assessment. It is basically a “rms” error. The mean-square error assessment is included for completeness but is generally not particularly useful.

The root-mean-square of $x(t)$ with zero mean over a short interval of time is computed as follows:

$$\hat{\psi}_x(t_i) = \sqrt{\int_{T_{i-1}}^{T_i} [x(t) - \mu_{x_i}]^2 dt} \leftrightarrow x_x(t_i) = \sqrt{\frac{1}{N_a - 1} \sum_{i=M-\lfloor N_a/2 \rfloor+1}^{M+\lfloor N_a/2 \rfloor} [x(t_i) - m_{x_i}]^2} \quad (3)$$

and the normalized random error for the root-mean-square estimate is given by,

$$\varepsilon[\hat{\psi}_x] \approx \frac{1}{2\sqrt{BT}} \text{ for } B, \text{ overall bandwidth of } x(t), \text{ and } T, \text{ averaging time.}$$

This estimate is essentially an estimate of the standard deviation of the time trace over a short time interval.

The mean-square of $x(t)$ with **zero mean** over a short interval of time is computed as follows:

$$\hat{\psi}_x^2(t_i) = \int_{T_{i-1}}^{T_i} x^2(t) dt \leftrightarrow std_x^2(t_i) = \frac{1}{N_a} \sum_{i=M-\lfloor N_a/2 \rfloor+1}^{M+\lfloor N_a/2 \rfloor} x^2(t_i) \quad (4)$$

For overall bandwidth B in Hz and averaging time T in seconds, the normalized random error for the mean-square estimate is given by

$$\varepsilon[\hat{\psi}_x^2] \approx \frac{1}{\sqrt{BT}}. \quad (5)$$

This estimate is essentially an estimate of the variance of the time trace over a short time interval.

That is the confidence interval with confidence coefficient $1 - \alpha$

on the standard deviation of a population (not necessarily a time history) obtained by a sample of size N , i.e.,

MIL-STD-810H
METHOD 525.2 ANNEX B

$$CI_{\sigma;1-\alpha} = \left[\frac{ns^2}{\chi_{n;\alpha/2}^2} \leq \sigma_x^2 \leq \frac{ns^2}{\chi_{n;1-\alpha/2}^2} \right] \text{ for } n = N - 1.$$

For application for $B = 2000\text{Hz}$ and $T = 0.01$ or 0.1 seconds the normalized random error for a mean comparable to the standard deviation, root-mean-square and mean-square is 0.16, 0.11, 0.22 respectively for averaging time of 0.01 seconds, and 0.05, 0.04, 0.07 respectively for averaging time of 0.1 seconds. To obtain a meaningful characterization of $x(t)$, it is important the normalized random error be minimized by as long an averaging time as is consistent with nominal bias error.

E3: COVARIANCE, CORRELATION, and SCATTER-PLOT (global and local)

Generally, covariance and correlation can be viewed as meaningful in the case of regression between a deterministic and a random time trace i.e., $r(t)$ and $c(t)$ Since $s(t) = c(t) - r(t)$ no new information is added by computing the correlation or covariance between $r(t)$ and $s(t)$. Covariance and correlation should be viewed in terms of a “regression fit” of $r(n)$ to $c(n)$. This particular replication error assessment is somewhat qualitative thus not particularly useful for tolerance specification e.g., specifying a correlation coefficient for tolerance would be too gross a parameter to be meaningful. The covariance relationship between two time traces over a short interval of time (local covariance), or over the entire time trace (global covariance) is computed in the time domain as follows:

$$\text{cov}(x, y) = \frac{1}{N} \sum_{i=1}^N (x_i - \bar{x})(y_i - \bar{y}) \quad (6)$$

This quantity can be normalized to provide the local or global correlation coefficient that can be expressed as follows:

$$r_{xy} = \frac{\sum_{i=1}^N (x_i - \bar{x})(y_i - \bar{y})}{\left[\sum_{i=1}^N (x_i - \bar{x})^2 \sum_{i=1}^N (y_i - \bar{y})^2 \right]^{1/2}} \quad (7)$$

The time trace basis for these expressions from traditional data analysis is as follows. For two arbitrary random processes $\{x_k(t)\}$ and $\{y_k(t)\}$ whose sample functions are indexed on k and for which the ensemble means are defined by $\mu_x(t) = E[x_k(t)]$ and $\mu_y(t) = E[y_k(t)]$ where expectation is over index k then the cross covariance function at arbitrary fixed values of $t_1 = t$ and $t_2 = t + \tau$ is given by

$$C_{xy}(t, t + \tau) = E\left[(x_k(t) - \mu_x(t))(y_k(t + \tau) - \mu_y(t + \tau)) \right]. \quad (8)$$

If $\tau = 0$ then $C_{xy}(t, t) = E\left[(x_k(t) - \mu_x(t))(y_k(t) - \mu_y(t)) \right] = C_{xy}(t)$, and this is of the form of the covariance expression above only where the expected value is not over an ensemble indexed on k , but over a finite time interval of length $N\Delta t$. The expression for r_{xy} is merely a “normalized” version of the expression for $\text{cov}(x, y)$ defined above. When the k^{th} sample functions $x_k(i\Delta t)$ and $y_k(i\Delta t)$ for $i = 1, 2, \dots, N$ are plotted on the x and y axes, respectively, the resulting plot is termed a “scatter-plot.” The “scatter-plot” depicts the degree of covariance or correlation between two time traces. For r_{xy} in the neighborhood of zero there tends to be no correlation between time traces, and the “scatter-plot” reveals an ellipse with major and minor axes approximately equal. For a distribution of r_{xy} close to either -1 or $+1$, there is substantial correlation between the time traces, and the “scatter-plot” provides an ellipse with a very small minor axis. In general “scatter-plot” information at the amplitude extremes is of most interest since this defines the correspondence between time trace peaks and valleys.

MIL-STD-810H
METHOD 525.2 ANNEX B

E4: PROBABILITY DENSITY, CUMULATIVE PROBABILITY, and QUANTILE (global)

A probability density function estimate is generally termed a histogram. A useful indicator of the form of time trace amplitudes is the histogram and its counterpart, the cumulative histogram. Generally, this analysis display is useful only for stationary time traces of substantial duration, e.g., 5 seconds or more. Time traces with even small time-varying root-mean-square levels almost always invalidate this procedure unless some finite distribution mixture can be specified. The histogram is useful usually when it is compared to a theoretical probability density function of an assumed form, e.g., the Normal probability density function. With time trace amplitude bins along the horizontal axis, and “bin counts” along the vertical axis, the logarithm of the bin counts may be used to examine the (1) shape of the histogram for the mid bin ranges, and (2) difference in tails for the small amplitude and the large amplitude bins. Because the probability structure of the difference can be so important in assessing the nature of TWR error, a rather complete discussion of its statistics is provided here. The probability density and probability estimate of $x(t)$

are defined as follows:

From paragraph 6.1, reference a, the probability of $x(t)$ taking values between $a - \frac{W}{2}$ and $a + \frac{W}{2}$ during time interval T (where “ a ” is amplitude level and “ W ” is a width designation for a time trace amplitude) is estimated as:

$$\hat{P}_x[a, W] = \text{Probability} \left[\left(a - \frac{W}{2} \right) \leq x(t) \leq \left(a + \frac{W}{2} \right) \right] = \frac{1}{T} \sum_i \Delta t_i = \frac{T_a}{T} \quad (9)$$

with $P_x[a, W] = \lim_{T \rightarrow \infty} \hat{P}_x[a, W] = \lim_{T \rightarrow \infty} \frac{T_a}{T}$. The probability density $p_x(a)$ is defined as:

$$p_x(a) = \lim_{W \rightarrow 0} \frac{P_x[a, W]}{W} = \lim_{T \rightarrow \infty} \frac{\hat{P}_x[a, W]}{W} = \lim_{W \rightarrow 0} \hat{p}(a) \text{ where } \hat{p}(a) = \frac{\hat{P}_x[a, W]}{W} = \frac{T_a}{TW}. \quad (10)$$

From this development, the cumulative probability density and probability density are related as follows:

$$\hat{P}_x[a] = \int_{-\infty}^a \hat{p}_x(\xi) d\xi \leftrightarrow \hat{P}_x[a] = \sum_{i=1}^N \hat{p}_x[a_i] \Delta a \quad (11)$$

The normalized mean square random error for the probability density estimate is given from paragraph 6.1, reference a as follows:

$\frac{c^2}{2BTWp_x(a)}$ where, for continuous bandwidth with noise $c \approx 0.3$. Since probability density estimates are particularly susceptible to bias error, the mean square bias error is given as

$$\frac{W^4}{576} \left[\frac{p_x''(a)}{p_x(a)} \right]^2 \text{ for } p_x''(a) \text{ the second derivative of evaluated } p_x \text{ at “a”}. \quad (12)$$

It may be useful to compare the probability structure of $x(t)$ directly to a known probability structure such as the Normal probability density/distribution. This can be done in this formulation by merely plotting the estimated probability structure of $x(t)$ along with the selected theoretical probability structure. There are both parametric and nonparametric statistical tests that allow comparison of probability structures at selected levels of significance. In particular, the nonparametric Kolmogorov-Smirnov test provides a basis for comparison of two sample probability distribution estimates or one sample probability distribution estimate with a theoretical probability distribution estimate. It is possible to use statistical hypothesis testing for purposes of tolerance specification provided the properties of such statistical tests are well understood and such tolerance specification is meaningful.

A strong visual test for equivalence of reference and control distributions is a plot of the quantiles of the two time history trace cumulative distribution probability functions, and is termed a quantile-quantile (q-q) plot. The quantile is defined in terms of the probability distribution function as follows:

MIL-STD-810H
METHOD 525.2 ANNEX B

For the probability distribution function F with probability density function f , the q^{th} quantile of F, x_q is defined as follows:

$$q_F = \int_{-\infty}^{x_q} f(x)dx \text{ where } 0 \leq q_F \leq 1 \left(\leftrightarrow q_F \approx \sum_{i=1}^{\hat{x}_q} \hat{f}(x_i)\Delta x_i \text{ where } 0 \leq q_F \leq 1 \right) \quad (13)$$

and similarly, for the probability distribution G with probability density function g , the q^{th} quantile of G, y_q is defined as:

$$q_G = \int_{-\infty}^{y_q} g(y)dy \text{ where } 0 \leq q_G \leq 1 \left(\leftrightarrow q_G \approx \sum_{i=1}^{\hat{y}_q} \hat{g}(y_i)\Delta y_i \text{ where } 0 \leq q_G \leq 1 \right) \quad (14)$$

For a given quantile q , the plot of \hat{x}_q versus \hat{y}_q on a rectangular axis is termed a “ $q-q$ plot.” F and G may be both analytical, both empirical (estimated from data), or a combination of analytical and empirical.

Examination of the “tails” or extreme values (peaks and valleys) along with the fit to a theoretical Gaussian distribution function, provides the most useful information.

Application of this procedure is most common for plotting the quantiles of the distribution of $s(t)$ against those of the Gaussian distribution function. It is also useful for empirical estimates of $r(t)$ and $c(t)$ against one another, or $r(t)$ and $c(t)$ separately against the Gaussian distribution quantiles. It is important to remember that in all such plots, particularly between $r(t)$ and $c(t)$ time correlation information is lost. It is noted that once the “probability” function of $s(t)$ is established then higher order moments related to skewness or kurtosis can be established.

E5: FRACTION-OF-TIME (global)

Closely related to the probability/quantile amplitude assessment in E4 is the Fraction-of-Time (FOT) assessment. For the FOT estimate of the error is above a certain magnitude and is assessed more intuitively and directly. It is also important to note that for FOT assessment, generally no theoretical distributional form is attached to the FOT estimate e.g., FOT is never spoken of as being Gaussian distributed, etc. For statistical analysis of time series the FOT assessment replaces the more traditional probability analysis., however, FOT distribution is a valid probability distribution function. For processing on a statistical basis the Fraction-of-Time (FOT) is defined as follows:

$$F_T(t; \xi; x) = \frac{\text{measure}\{u \in [t, t+T] : x(u) \leq \xi\}}{\text{measure}\{u \in [t, t+T]\}} = \frac{1}{T} \int_t^{t+T} U(\xi - x(u))du \quad (15)$$

where

$$U(\tau) = \begin{cases} 1 & \tau \geq 0 \\ 0 & \text{elsewhere} \end{cases}$$

For the error time trace, $s(t)$, FOT allows assessment of the percentage of time the error is above a certain level and a correct display would indicate the times along the reference time trace $r(t)$ for which this occurs. Generally, this is summarized in a single plot similar to the probability based cumulative distribution function estimate. Thus if

$F_T(t; \xi_1; s) \leq 0.05$ and $F_T(t; \xi_2; s) \geq 0.05$ then $s(t)$ lies between ξ_1 and ξ_2
ninety percent of the TWR test time where it is assumed ξ_1 and ξ_2
can be related to some level of the reference e.g., the range of the reference,
for purposes of developing a test specification on replication error.

MIL-STD-810H
METHOD 525.2 ANNEX B

E6: ASD/ESD/PERIODOGRAM (global)

For a deterministic time trace such as $r(t)$ a frequency domain estimate is meaningful and similar to the fitting of a Fourier series to an analytically defined function. Visual comparison between frequency domain estimates for $r(t)$ and $c(t)$ can be made and the ratio of the estimates at each frequency line provided by ratioing the computed quantities (this must never be interpreted as a “transfer function estimate” between the reference and the control time traces). It might be noted that for TWR the “transfer function estimate” is provided in the vendor software in the form of the frequency domain Fourier “drive signal compensation” function. The frequency domain estimates provide for tolerance specification that is directly related to tolerance specifications in Method 514. The basic definition of the windowed two-sided periodogram for an N point digital sequence $\{x_t, t = 1, 2, \dots, N\}$ in continuous frequency form is as follows:

$$\hat{P}^{(p)}(f) = \frac{\Delta t}{N} \left| \sum_{t=1}^N w_t x_t e^{-i2\pi f t \Delta t} \right|^2 \quad \text{for } -.5 \leq f \leq .5 \quad (16)$$

Generally the two-sided periodogram is made one sided by multiplying by a factor of 2 with $0 \leq f \leq 0.5$, and the periodogram is sampled at discrete frequencies, f_i for $i = 0, 1, 2, \dots, N/2$ with a uniform spacing of $\Delta f = 1/N\Delta t$. The ASD and ESD can be defined in terms of the sampled periodogram. An ASD estimate is typically a time average sampled periodogram estimate over a limited time interval, with an applied window to reduce spectrum leakage. For stationary time traces the ASD represents a powerful means of comparison between $r(t)$ and $c(t)$, and a display of the frequency content in $s(t)$. Paragraph 6.1, reference a provides information on ASD processing of stationary time traces including normalized random and bias error estimates. For analysis filter bandwidth B_e in Hz, and averaging time T in seconds, the normalized random error for the ASD estimate is given by

$$\varepsilon_r \left[\hat{G}_{xx}(f) \right] \approx \frac{1}{\sqrt{B_e T}} \quad (17)$$

while the normalized bias error is given by

$$\varepsilon_b \left[\hat{G}_{xx}(f_r) \right] = \frac{B_r}{B_e} \tan^{-1} \left(\frac{B_e}{B_r} \right) - 1 \quad (18)$$

where

$$B_r \approx 2\zeta f_r$$

is an estimate of the half-power bandwidth of a resonant peak.

An ESD estimate is typically a scaled periodogram, scaled by multiplying the periodogram by the duration of the time trace $N\Delta t$, over a very short transient time trace that cannot be characterized by an ASD estimate. A uniform or end tapered uniform time window is generally placed over the significant portion of the time trace. For transient TWR time traces, ESD estimates are useful for comparing $r(t)$ and $c(t)$ in addition to examining the character of $s(t)$.

E7: SRS – Shock Response Spectra (global)

As in the case of the frequency domain estimates in E6 a comparison between SRS estimates for deterministic $r(t)$ and stochastic $c(t)$ can be made. The SRS estimate for the error time trace $s(t)$ is related to an SRS estimate for pre-shock and post-shock considered to be random in nature (see Method 516). The SRS may be expressed as a time domain convolution of an impulse response function that has the character of the response to base-input of the mass of a single-degree-of-freedom mechanical system, with a certain percentage of critical damping. The SRS estimate is a function of the output of the mass displacement, velocity, and acceleration. If the maximum absolute acceleration (positive or negative) is selected over the time interval of excitation, and plotted versus the undamped natural frequency of the single-degree-of-freedom system, the resulting plot over a selected set of frequencies is referred to as a maximax

MIL-STD-810H
METHOD 525.2 ANNEX B

shock response spectrum. It is becoming increasingly evident that for most cases of mechanical shock the pseudo-velocity SRS estimate is a more indicative measure of potential for mechanical damage (because mechanical damage is related to mechanical stress that, in turn, is proportional to relative velocity of a mass-spring-damper system). Various references provide the details of SRS computation. For transient time trace TWR comparison, the SRS of $r(t)$ and $c(t)$ is useful and demonstrates the faithfulness of shock reproduction under TWR. Computing the SRS for $s(t)$ is less useful and difficult to interpret since random variable S should represent a noise source but not Normal distributed. The mathematics for the SRS computation over a transient $x(t)$ for $0 \leq t \leq T_r$ is given as follows:

$$SRS(f_n, \zeta) = \mathfrak{F}[y(t, f_n, \zeta)] = \mathfrak{F}\left[\int_0^{T_r} h_{f_n, \zeta}(t-\tau)x(\tau)d\tau\right] \text{ for } 0 \leq T_r \leq T$$

where,

- $SRS(f_n)$ - the magnitude of the SRS at natural frequency f_n
- \mathfrak{F} - a nonlinear functional operating on the resulting convolution $y(t, f_n, \zeta)$
- $h_{f_n, \zeta}(t-\tau)$ - impulse function response for a damped single-degree-of-freedom system with base input and undamped natural frequency f_n having damping ratio ζ .
- $x(\tau)$ - finite input record $0 \leq t \leq T_r$
- T - time of response assessment where generally $T_r < T$

Natural frequency, f_n , can extend beyond the sampling frequency of $x(t)$. The SRS estimate is computed through filtering a transient time record, and does not have a clear random error or bias error criterion. Numerically, the time trace sample rate should be ten times the bandwidth of the time trace in order to provide an acceptable error in the estimates (approximately 5 percent error).

4. REPLICATION ERROR TOLERANCE SPECIFICATION.

From the analyst point of view it is highly desirable to attempt to apply each of the expressions in paragraph 3 to assess the replication error. However, when it comes to TWR test tolerance specification only a few of these expressions can be easily interpreted after application. For example, requiring $s(t)$ to be zero mean Gaussian with a specified standard deviation as a fraction of the peak values in $r(t)$, for a test to be within tolerance is unrealistic. Requiring correlation between $r(t)$ and $s(t)$ to be a set value e.g., 0.975, is likewise not practical nor meaningful. The TWR test tolerance specifications below should be easily interpreted and reflect the descriptive convenience of the expressions in paragraph 3. Generally for post-analysis processing to determine test tolerance compliance it is highly desirable that replication error tolerance specifications be tailored to the form of the time history being replicated and formally agreed to before testing. The varied form of $r(t)$, i.e., stationary, nonstationary, shock, Gaussian, non-Gaussian or any combination of all of these, requires replication error tolerance specification to be tailored based upon the form of $r(t)$. such tolerance specification is complicated by the fact that almost assuredly some form of windowing and averaging will need to be applied for which random and bias processing errors are not easily determined to be nominal. It is usually unclear as to the reference for the specification and if multiple references need to be provided as a function of the form of $r(t)$. In this case then there may be multiple replication error assessments and subsequent tolerance specifications.

For the suggested replication error test tolerances it is assumed that the measure of $r(t)$ is a form of general amplitude “rms” level derived by computing the “average energy” of $r(t)$ in terms of units-squared and then taking the square-root of this value. For Time Domain Moments this relates to the “root-energy-amplitude” except the rms duration of $r(t)$ becomes the time averaging factor. For well defined transient vibration forms of $r(t)$ or forms of $r(t)$ for which root-mean-square duration is meaningful it is suggested that the reference of the specification be the “root-energy-amplitude”. For the tolerance specifications proposed below the reference “root-energy-amplitude” (REA) is provided by the following expression:

MIL-STD-810H
METHOD 525.2 ANNEX B

$$REA = \sqrt{\frac{1}{T} \int_0^T r^2(t) dt} \leftrightarrow \sqrt{\frac{1}{N} \sum_{i=1}^N r^2(t_i)}$$

where removal of the overall mean of $r(t)$ before computing REA is left to the form of $r(t)$ and discretion of the analyst. This is a very general root-mean-square $r(t)$ signal level and for multiple test tolerance specifications may be applied over segments of $r(t)$. (Other possible reference scaling, for example, might be the reference range which is generally very sensitive to outliers.)

There are five general categories of replication error tolerance specifications proposed here:

The first category relates directly to $s(t)$ and is referenced for convenience to the overall “root-mean-square” level of $r(t)$ defined as REA above. Of the two specifications the root-mean-square error is the most significant.

Category I. The mean error, for which the STA is estimated for the oversample time interval factor on $r(t)$, shall not exceed more than 1% of the rms amplitude of $r(t)$, REA, over more than 5% (or 0.95 quantile) of the duration of $r(t)$.

The root-mean-square error, for which the STA is estimated for the oversample time interval factor on $r(t)$, shall not exceed more than 10% of the rms amplitude of $r(t)$, REA, over more than 5% (or 0.95 quantile) of the time.

The second category relates to (1) stationary random portions of $r(t)$, (2) a periodogram estimate i.e., ESD, over $r(t)$ or (3) some combination of (1) and (2). For Fourier based processing of $r(t)$ and $c(t)$ an ASD, a periodogram or an ESD estimate is assumed available for $r(t)$ and $c(t)$. This includes stationary random vibration – Gaussian or non-Gaussian and shock specified in terms of an ESD estimate.

Category II. For portions of frequency domain the replication error related to the ASD or periodogram (ESD) shall not exceed the tolerance limits proposed for stationary random vibration when deterministic $r(t)$ is considered the reference (see Method 514).

For the third category whereby a “Product Model” may be fit to $r(t)$ of the form of a transient vibration then it is assumed that the analysis has defined $r(t)$ in terms of a PM with a time domain rms estimate and an appropriately scaled normalized ASD estimate.

Category III. For the frequency domain portion of the PM, tolerance specification according to the Category II will apply. For the time domain portion of the PM tolerance specification according to Category I will apply.

The fourth category relates directly to $r(t)$ as the form of a “shock” for which SRS estimates provide the most meaningful information.

Category IV. For shock the tolerance specification shall be in accord with that in Method 516. That is the tolerance specification shall not exceed the tolerance proposed for the SRS in Method 516 where deterministic $r(t)$ is considered the reference against $c(t)$

The fifth category is very general and is based upon the FOT probability distribution as applied to the error $s(t)$. FOT is able to quantify the time for which the error is at or above a specified quantile level.

Category V. The 5th and 95th quantile of the FOT related to $s(t)$ (for which no STA has been computed) shall not exceed more than 10% of the plus and minus rms amplitude of $r(t)$.

MIL-STD-810H
METHOD 526.2**METHOD 526.2****RAIL IMPACT****CONTENTS**

<u>Paragraph</u>	<u>Page</u>
1. SCOPE	1
1.1 PURPOSE	1
1.2 APPLICATION	1
1.3 LIMITATIONS.....	1
2. TAILORING GUIDANCE	1
2.1 SEQUENCE AMONG OTHER METHODS.....	1
2.1.1 EFFECTS OF RAIL IMPACT	2
2.2 DESIGN AND MODELING GUIDANCE	2
3. INFORMATION REQUIRED.....	2
3.1 PRETEST.....	2
3.2 DURING TEST.....	3
3.3 POST-TEST	3
4. TEST PROCESS	3
4.1 TEST FACILITY AND EQUIPMENT.....	3
4.1.1 BUFFER RAILCARS	3
4.1.2 TEST RAILCAR	3
4.1.3 LOCOMOTIVE	4
4.1.4 TRACK	4
4.1.5 INCLINED TRACK	4
4.2 CONTROLS	4
4.3 TEST INTERRUPTION	5
4.3.1 INTERRUPTION DUE TO FACILITY MALFUNCTION.....	5
4.3.2 INTERRUPTION DUE TO TEST ITEM OR SECUREMENT FAILURE	5
4.4 TEST SETUP.....	5
4.4.1 PREPARATION FOR TEST.....	6
4.5 TEST TOLERANCES.....	6
4.6 RAIL IMPACT PROCEDURE.....	6
4.7 ADDITIONAL REQUIREMENTS.....	9
5. ANALYSIS OF RESULTS	9
6. REFERENCE/RELATED DOCUMENTS	10
6.1 REFERENCED DOCUMENTS.....	10
6.2 RELATED DOCUMENTS.....	10

FIGURES

FIGURE 526.2-1. RAIL IMPACT TEST	7
FIGURE 526.2-2. TIEDOWN CHAIN ANGLE OF 45 DEGREES IN THE SIDE VIEW; THE DIMENSIONS SHOWN ARE ALL EQUAL.....	8

MIL-STD-810H
METHOD 526.2

(This page is intentionally blank.)

MIL-STD-810H
METHOD 526.2

METHOD 526.2

RAIL IMPACT

1. SCOPE.

1.1 Purpose.

The purpose of this test method is to replicate the railroad car impact conditions that occur during the life of transport of systems, subsystems and units, hereafter called materiel, and the tiedown arrangements during the specified logistic conditions. The requirements of this Method are based on the commercial rail transport requirements of the Association of American Railroads (AAR) Open Top Loading Rules.

NOTE: Although the number of railroad car impacts that occur throughout the life of the materiel may exceed the number applied in this Method, it is unlikely that impacts at or above 12.9 km/h (8 mph) will occur more often than the impacts defined in the Method.

1.2 Application.

The rail impact test is intended to test materiel that will be transported by rail; to determine the effect of railroad car impacts that may occur during rail shipment, to verify the structural integrity of the materiel, to evaluate the adequacy of the tiedown system and the tiedown procedures, and to assess transportability (see paragraph 6.1, reference c definitions) in accordance with Military Surface Deployment and Distribution Command Transportation Engineering Agency (SDDCTEA) policy. All items are to be tested at their maximum gross weight (fully loaded) rating unless otherwise specified in the transportability requirements for the materiel (see paragraph 4.2b).

1.3 Limitations.

This method is not intended for railcar crash conditions, or for separate testing of small, individually packaged pieces of materiel that would normally be shipped (and tested) when mounted on a pallet, or as part of larger materiel. For the latter, the referenced documents (paragraph 6.1) provide guidance on environments measured during rail impact that may be useful in specially tailored laboratory testing. All developed loads consisting of ammunition and explosive items must be reviewed and approved by the appropriate approval authority (see paragraph 6.1, reference f).

2. TAILORING GUIDANCE.

This method is tailorable only for cargo requiring extraordinary attention, e.g., one-of-a-kind, high value, or key military materiel. Any changes to the test procedure and criteria must be approved by the Director, SDDCTEA, Attn: SDTE-DPE, Building 1900W, 1 Soldier Way, Scott AFB, IL 62225.

2.1 Sequence Among Other Methods.

- a. General. Use the anticipated life cycle sequence of events as a general sequence guide (see Part One, paragraph 5.5).
- b. Unique to this method. Sequencing among other methods will depend upon the type of testing i.e., developmental, qualification, endurance, etc., and the general availability of test items for test. Normally, schedule shock tests early in the test sequence, but after any vibration tests. The order of the rail impact testing will be determined by the requesting organization, and specific sequential test requirements should be stated in the test plan.
- c. Considerations.
 - (1) If the rail impact environment is deemed particularly severe, and the chances of materiel survival without major structural or functional failure are small, the rail impact test should be first in the test sequence. This provides the opportunity to redesign the materiel to meet the rail impact requirement before testing to the more benign environments.

MIL-STD-810H
METHOD 526.2

- (2) If the rail impact environment is deemed severe but the chances of the materiel survival without structural or functional failure is good, perform the shock test after vibration and thermal tests, allowing the stressing of the test item prior to rail impact testing to uncover combined vibration, temperature, and shock environmental failures.
- (3) If the rail impact environment could damage joints or seals or otherwise affect Electromagnetic behavior, perform the rail impact test before Electromagnetic Environmental Effects Testing.
- (4) There are often advantages to applying rail impact tests before climatic tests, provided this sequence represents realistic service conditions. Test experience has shown that climate-sensitive defects often show up more clearly after the application of the rail impact environment. However, internal or external thermal stresses may permanently weaken materiel resistance to vibration and rail impact that may go undetected if shock tests are applied before climatic tests.

2.1.1 Effects of Rail Impact.

Rail impact shock has the potential for producing adverse effects on the physical and functional integrity of transported materiel. The following are examples of problems/failures that could occur when materiel is exposed to the rail impact environment.

- a. Loosening of restraints.
- b. Failure of attachments, creating a safety hazard.
- c. Shifting of materiel on the railcar.
- d. Failure of materiel.
- e. Structural failure.
- f. Fuel spills.

2.2 Design and Modeling Guidance.

If it is desired to determine if a test item is capable of withstanding the rail impact environment, an analytical simulation may be created to predict response levels on the item of interest. A rail impact shock example for the railcar deck was computed for use in design specifications and may be used as a starting point for dynamic models of materiel transported by rail. Detailed information can be obtained from paragraph 6.1, reference b, that provides insight to support shock design for rail transport, but should not be considered as approved design guidance. Subjecting materiel to a lab shock test or performing an analytical simulation does not eliminate the requirement to conduct a rail impact test.

3. INFORMATION REQUIRED.

3.1 Pretest.

The following information is required to conduct rail impact tests adequately.

- a. General. Information listed in Part One, paragraphs 5.7 and 5.9; and Annex A, Task 405 of this standard.
- b. Specific to this method.
 - (1) Required test item orientations for testing (possible rail car shipping orientations).
 - (2) Timing device details, including accuracy, calibration, and location(s).
 - (3) Test setup photographs, including any securement items.
 - (4) Buffer car(s) weight, and type of draft gear for each buffer car.
 - (5) Type of rail car and draft gear (cushioned or other).
 - (6) Empty weight of the test car.
 - (7) Test item weight.
 - (8) Record of the test standard or alternate procedure (test plan) followed.

MIL-STD-810H
METHOD 526.2

- (9) The pass/fail criteria. The criteria shall be provided by the program manager and approved by the certification authority, (SDDCTEA).
- c. Tailoring. Cargo requiring extraordinary attention, e.g., one-of-a-kind, high value, or key military materiel, may justify changes to the test procedure and criteria; the developer or Program Manager must identify these and they must be approved by the Director, SDDCTEA, Attn: SDTE-DPE, Building 1900W, 1 Soldier Way, Scott AFB, IL 62225 (see paragraph 6.1, reference d). Also, document necessary variations in the basic test procedures to accommodate LCEP requirements and/or facility limitations.

3.2 During Test.

Collect the following information during conduct of the test:

- a. General. Information listed in Part One, paragraph 5.10; and in Annex A, Tasks 405 and 406 of this standard.
- b. Specific to this method.
 - (1) Impact speeds for each impact and direction, and test item orientation.
 - (2) Test item or securement items failures or loosening (if any), with photographs and corrective action(s).
 - (3) Buffer car(s) displacement following each impact which is related to the payload weight and the impact velocity. This also provides information on the effectiveness of the buffer car(s) brakes.
 - (4) Shock levels on the test railcar is recommended to ensure that the coupling system is functioning properly and the response of the test railcar is within credible bounds for the speeds tested.
 - (5) Shock levels on the test item is recommended to provide data to system designers and developers.

3.3 Post-Test.

The following post-test data shall be included in the test report.

- a. General. Information listed in Part One, paragraph 5.13; and in Annex A, Task 406 of this standard.
- b. Specific to this method.
 - (1) Document and photograph any physical damage to the test item.
 - (2) Record of the test item or securement items failures or loosening (if any), with photographs.
 - (3) Any deviation from the original test plan.
 - (4) Record of functional test results.

4. TEST PROCESS.

4.1 Test Facility and Equipment.

The following are requirements for performance of the basic rail impact test (see Figure 526.2-1).

4.1.1 Buffer Railcars.

Loaded cars are preferred for use as the buffer or struck cars. However, empty cars may also be used. In either case, the total weight of the buffer cars shall be at least 113,400 kg (250,000 lb). The first buffer car must be a standard draft gear car. The remaining buffer cars should have standard draft gear, if possible. The AAR conducts 'field rail impact tests' at locations other than DoD test centers. For these 'field rail impact tests', unloaded buffer cars may be preferred so that the loads on/in the available buffer cars are not damaged during the impacts. The SDDCTEA needs to approve the use of loaded cars for a 'field rail impact test'.

4.1.2 Test Railcar

Test railcars shall be equipped with chain tiedowns and end-of-car cushioned draft gear, unless other railcar types are approved by Director, SDDCTEA, Attn: SDTE-DPE, Building 1900W, 1 Soldier Way, Scott AFB, IL 62225. SDDCTEA is the designated DoD agent for land transportation. Some materiel may require other types of railcars for testing to be representative of the intended shipping methods.

MIL-STD-810H
METHOD 526.2

4.1.3 Locomotive.

At least one locomotive or railcar mover capable of moving the railcars up to the required impact speeds. If a locomotive or railcar movers is not available see paragraph 4.1.5, Inclined Track.

4.1.4 Track.

A minimum 61 m (200 ft) length of dry, level, tangent track is required between the buffer cars and test car to allow acceleration of locomotive and test car to specified impact speeds.

4.1.5 Inclined Track.

If a locomotive is not available to accelerate the test car, use an inclined tangent track in lieu of a locomotive.

4.2 Controls.

- a. Load and secure the test item as would be done for actual rail transport. All contact areas of the test item railcar, lading, and securement items must be free of ice, snow and debris. The tiedown provisions shall provide the entire restraint of the test item without any other restraint such as blocking, vehicle brakes or other added material. If safety or other reasons preclude the use of a test item representative of the secondary load, use a substitute test item that is equal in weight and similar dynamic characteristics to the materiel. Prior to using a substitute test item, obtain approval from SDDCTEA.
 - (1) Wheeled Vehicles. Tires must be inflated as uniformly as possible to the tire manufacturer's recommended highway pressures.
 - (2) Trailers. Unless otherwise specified in the detailed test plan and approved by SDDCTEA, trailers should be tested both connected to and disconnected from their prime mover. When the trailer is tested disconnected from its prime mover, secure it to the railcar either with the lunette resting on the deck (the lunette may need insulation/padding to prevent metal-on-metal contact with the deck of the railcar), landing legs extended, or tested as a Trailer-On-Flatcar (TOFC), whichever is appropriate. Lumber or hardware that are not a Basic Issue Item (BII) for the trailer may not be added. This prohibits the use of wooden stanchions.
 - (3) Vehicle Fuel Tanks. Ensure all fuel tanks for test items are approximately 3/4 full during the test (see paragraph 6.1, reference d).
 - (4) Fuel and other Bulk Liquid Tankers. Unless otherwise specified in the requirements documents, fuel and other bulk liquid tankers should be subjected to Rail Impact testing at both 60 percent full and fully loaded conditions. The maximum sloshing force is generated when the liquid fill percentage is close to 60 percent. Therefore, for tank vehicles, a liquid fill percentage close to 60 percent is the worst laden state (see paragraph 6.1, reference e). If it is desired, or there is a need, to use a substitute for fuel (i.e. HAZMAT concerns), contact SDDCTEA for approval.
 - (5) Variable height or pneumatic suspensions. Vehicles may be equipped with either variable height or pneumatic suspensions. Variable height suspensions must be lowered into transport mode and pneumatic suspensions must be bled prior to securing the vehicle to the railcar so that the vehicle is resting on hard stops. If applicable, all manually inserted suspension stops must be inserted and secured. This is done to prevent air suspensions from leaking and losing pressure causing the vehicle to lower significantly in transit and introduce an unsafe amount of chain slack.
- b. Unless otherwise specified in the transportability requirements for the materiel, perform the test with the test item at its maximum gross weight (fully loaded) rating. Exceptions to including payload as part of the vehicle weight are vehicles that do not carry a payload during transport such as wreckers, dump trucks, and material handling equipment.
- c. When testing a vehicle(s) ensure the parking brake(s) is released and the transmission(s) is placed in the neutral position. This ensures the transmission and the brakes are not part of the test item securement. Vehicles equipped with air brakes should have the brake system pressurized (brakes released). This will validate the restraint method for the worst case condition - no brakes applied. Vehicle restraint would be enhanced if a vehicle's air brake system were to bleed causing the brakes to engage in route during actual rail transport.

MIL-STD-810H
METHOD 526.2

4.3 Test Interruption.

Test interruptions can result from two or more situations, one being from a failure or malfunction of test facilities or associated test laboratory equipment. The second type of test interruption results from securement failure or malfunction of the test item itself during required or optional performance checks.

4.3.1 Interruption Due To Facility Malfunction.

- a. General. See Part One, paragraph 5.11, of this standard.
- b. Specific to this method.
 - (1) Undertest interruption. If an unscheduled interruption occurs that causes the test conditions to fall below allowable limits, the test must be reinitiated at the end of the last successfully completed cycle.
 - (2) Overtest interruption. If the test item(s) is exposed to test conditions that exceed allowable limits, conduct an appropriate physical examination of the test item and perform an operational check (when practical) before testing is resumed. This is especially true where a safety condition could exist, such as with munitions. If a safety condition is discovered, the preferable course of action is to terminate the test and reinitiate testing with a new test item. If this is not done and test item failure occurs during the remainder of the test, the test results may be considered invalid. If no problem has been encountered, reestablish pre-interruption conditions and continue from the point where the test tolerances were exceeded.

4.3.2 Interruption Due To Test Item Or Seurement Failure.

Failure of the test item(s) or items of securement to function as required during performance checks during testing presents a situation with two possible options.

- a. The preferable option is to replace the test item with a “new” item and restart from Step 1.
- b. A second option is to replace/repair the failed or non-functioning component or assembly with one that functions as intended, and restart the test from Step 1.
- c. In the event of a securement failure, re-secure and/or add additional tie-downs approved by SDDCTEA prior to continuation of testing and restart the test from Step 1. Only use an arrangement of the test item and its tie-down to be tested that is identical to that proposed or approved by SDDCTEA.

NOTE: When evaluating failure interruptions, consider prior testing on the same test item and consequences of such.

4.4 Test Setup.

- a. Buffer car(s) must have their air and hand brakes set. This provides a more conservative test. Cars must be bunched with a locomotive or railcar mover to compress all slack and cushioning in the couplings, if any. The struck end of the first buffer car must have standard draft gear.
- b. Locate the test car between the buffer car(s) and the locomotive or railcar mover.
- c. Install one of the following timing devices (or equivalent) to obtain the impact speed of the test car.
 - (1) An electric timing system capable of measuring within ± 0.16 km/h (± 0.1 mph): Place the switch contacts on the track in accordance with manufacturer's instructions.
 - (2) Radar: In order to obtain an accurate speed, position the radar in line with the direction of impact or as otherwise recommended by the radar manufacturer. Verify that the radar can accurately measure speeds in the 5.6 km/h to 13.7 km/h (3.5 to 8.5 mph) range with a tolerance of ± 0.16 km/h (± 0.1 mph). For safety, the radar operator should be positioned so as to aim at the test car moving away from their position.
 - (3) A speed sensor (GPS based or other) located on the test car capable of measuring within ± 0.16 km/h (± 0.1 mph).

MIL-STD-810H
METHOD 526.2

The speed measuring device must have a current and verifiable calibration certificate.

- d. Photograph the test setup including any securement items. This may be a valuable tool if there is any subsequent failure of the items of securement.

4.4.1 Preparation for Test.

- a. The materiel developer is responsible for the development of transportation procedures and instructions, and is responsible for coordinating these with and obtaining approval from SDDCTEA well in advance of rail impact testing. Inspect all chain assemblies for signs of stretching, gouging, or other damage to include the compression units. Mount and secure the test item as would be done in actual service and in accordance with the standard loading methods shown in paragraph 6.1, reference a, and Figure 526.2-1. Do not use more than four tiedown provisions, typically two at each end of the test item as defined by MIL-STD-209, Lifting and Tiedown Provisions (see paragraph 6.1, reference g). If the item requires more than four tiedown provisions, approval to deviate from MIL-STD-209 is needed from SDDCTEA prior to testing. Place the vehicle(s) on the flatcar so the tiedown chain makes approximately a 45 degree angle with the flatcar's deck when viewed from the side. Measuring by eye is usually good enough. To layout the correct angle with a tape measure, make the longitudinal distance from the point the tiedown attaches to the deck to the tiedown provision on the vehicle equal to the vertical distance from the deck to the provision (Figure 526.2-2). Do not cross tiedowns unless prior approval is granted by SDDCTEA. Once all chain tiedowns are secure, assure proper tension in all tiedowns. A properly tensioned tiedown will not tighten a compression unit such that there is no gap (go solid) that eliminates the shock mitigation. Only use an arrangement of the test item and its tiedown to be tested that is identical to that proposed or approved by SDDCTEA.
- b. If required, install transducers on the test railcar and test item sufficient to measure acceleration and any other required parameters. Protect transducers to prevent contact with surfaces other than the mounting surface.
- c. If appropriate, perform an operational test to establish baseline data to be used in post-test analysis.

4.5 Test Tolerances.

Ensure test tolerances are in accordance with tolerances specified in paragraphs 4.4 and 4.6, and in the test plan.

4.6 Rail Impact Procedure.

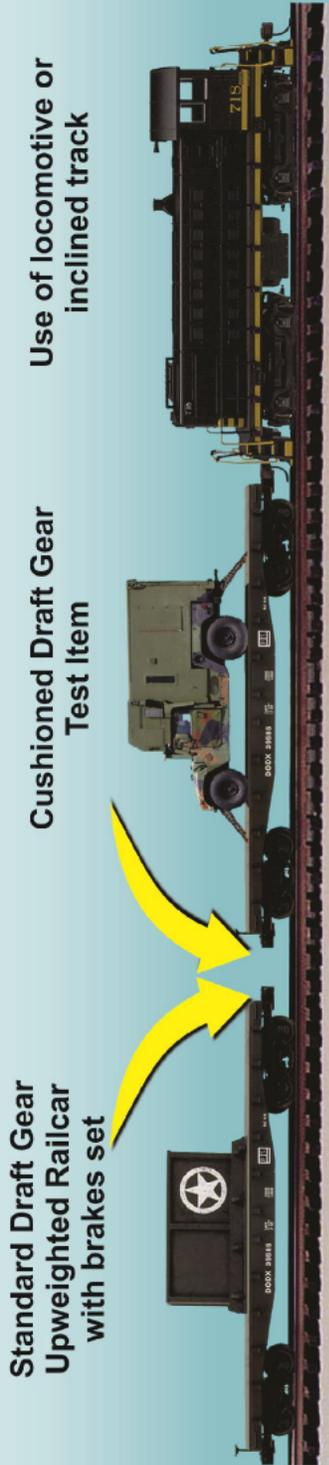
The method for accelerating the test car will vary depending on the test facility. Typically, the test car can be accelerated using a locomotive or an inclined track. Use the steps below that apply to your test facility.

- Step 1a (Locomotive). Brief the train crew on the procedure. Delegate one person to advise the appropriate member of the train crew when moves are to be made. Instruct all participants and observers to take precautions for their personal safety and observe safety practices of the carrier and/or company conducting the test. If desired, perform a test run without impacting the test item to establish accuracy of speed.
- Step 1b (Inclined track). A section of track can be calibrated using a test car and speed-measuring device. Release the test car from the designated starting point and allow it to roll freely down the inclined track. Drop markers at the locations where the test car reaches the desired speeds. Ensure no other cars are present on the test track during the calibration process. Repeat the process at least twice to ensure the accuracy of speed locations. Next, release the test car from the same starting point and make adjustments in markers if needed prior to impacting. Speeds still need to be measured during the actual test as described above in paragraph 4.4c.
- Step 2a (Locomotive). Pull the rail car carrying the test item a sufficient distance from the buffer cars. Next, push the test load car toward the buffer car(s) until the desired speed is obtained, and release it so it rolls freely into the buffer car(s) - having knuckles open and positioned for coupling.
- Step 2b (Inclined track). After determining speed locations, perform impacts by locating the buffer cars at the proper location for desired impact speed, and for releasing the test car from the designated starting point. This requires moving the buffer cars every time a different speed is required. In lieu of repositioning of the buffer cars at various positions on the track, release the test car from calibrated positions on the inclined track that correspond to the desired speeds.

RAIL IMPACT TEST

Buffer Car(s)
Minimum Total Weight of 250,000 lbs.

Test Car
Test Item Loaded to Maximum Gross Weight Rating



Test Impact Speed and Direction
- Forward 4, 6, and 8 mph
- Reverse 8 mph

1. Loading - load and secure the item as would be done for actual rail transport.
2. Fuel Tanks - ensure vehicle fuel tanks for test item are approximately 3/4 full during test.
3. When testing vehicles - ensure the parking brakes are released and the transmission is placed in the neutral position. This ensures the transmission and the brakes are not part of the test item securement.
4. Trailers - connect any trailers to their prime mover if there is adequate space on the test car.
5. Buffer Car - must have their air and hand brakes set.
6. Track - minimum of 61m (200 ft) length of dry, level tangent track is required between the buffer car and the test car to allow acceleration of the locomotive and test car to specified speeds.
7. Tiedowns - cannot be adjusted between impacts.

Figure 526.2-1. Rail Impact Test.

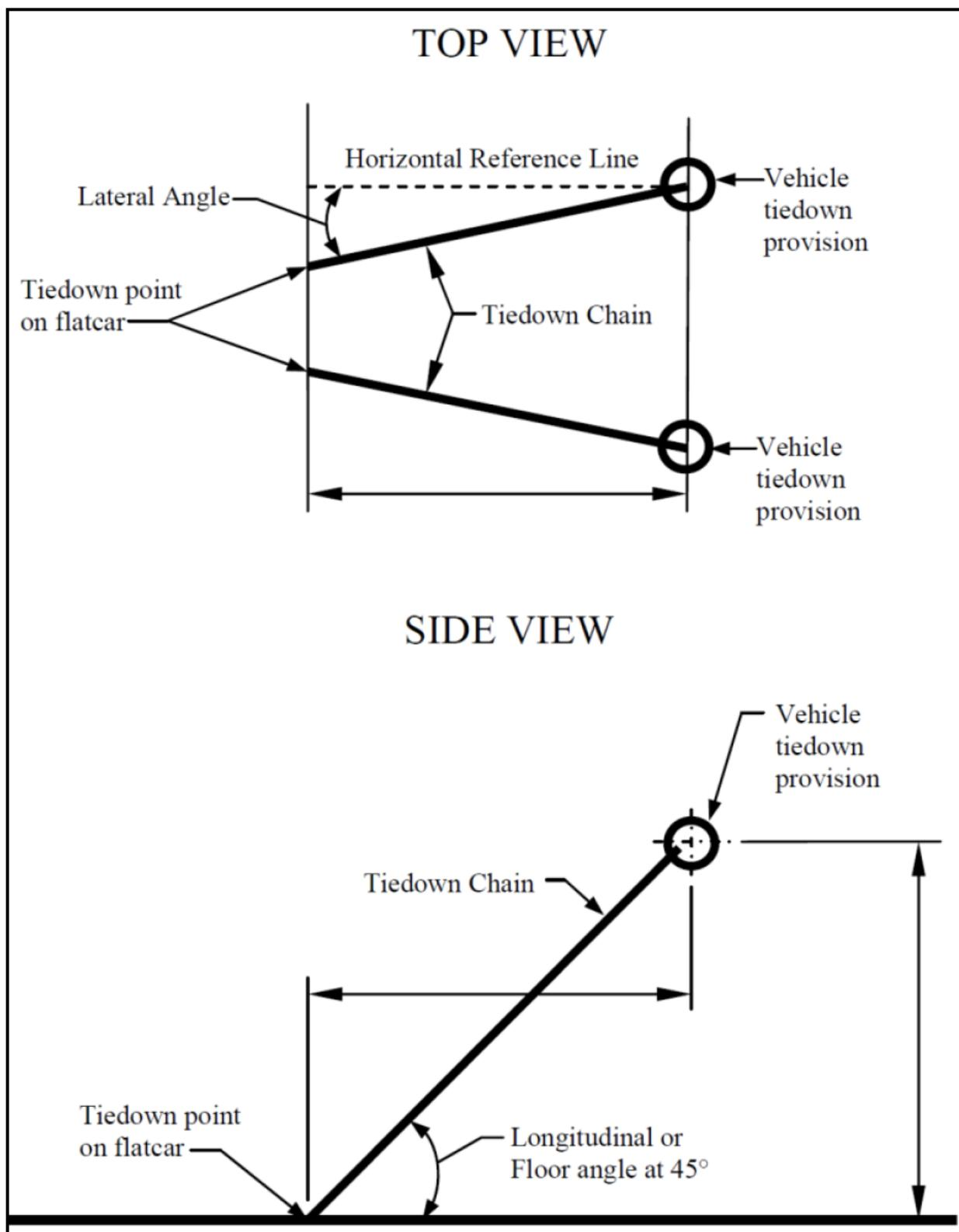
MIL-STD-810H
METHOD 526.2

Figure 526.2-2. Tiedown chain angle of 45 degrees in the side view; the dimensions shown are all equal.

MIL-STD-810H
METHOD 526.2

- Step 3 Subject the test item to four impacts, the first three of which are in the same direction and at speeds of 6.4, 9.7, and 12.9 km/h (4, 6, and 8 mph) respectively, each speed with a tolerance of ± 0.8 km/h (± 0.5 mph) for the 6.4 and 9.7 km/h impacts, and $+0.8, -0.0$ km/h ($+0.5, -0.0$ mph) for the 12.9 km/h impacts. Perform the fourth impact at 12.9 km/h ($+0.8, -0.0$ km/h) (8 mph ($+0.5, -0.0$ mph)) impacting the opposite end of the test car from the first three impacts. If it is not possible to turn the test car because of track layout, this may be accomplished by running the test item car to the opposite end of the buffer cars and impacting as above.
- Step 4 If the lading or securement items loosen or fail during the test, photograph and document these items. If it appears necessary to adjust the lading or securement items to continue the test, correct the restraint and restart the test from the beginning and follow the guidance provided in paragraph 4.3.2.
- Step 5 If the materiel can be shipped in two orientations (such as lengthwise and crosswise on the rail car), repeat the four impacts for each orientation or have two test items on the test railcar one mounted in each orientation.
- Step 6 Perform a posttest operational check for comparison with pre-test data, and see paragraph 5 for analysis of results.

4.7 Additional Requirements.

- Step 1 Repeat any impacts that are below the required test speeds. If any readjustment of the lading or reconditioning of the bracing or items of securement is necessary, correct, photograph, and document the problem(s), correct the restraint, and restart the entire test beginning with the 6.4 km/h (4 mph) impact. Accept any impacts above the required test speed providing the test item satisfies the requirements of paragraph 5.
- Step 2 If the tiedown chains become loose, or if there is visible permanent deformation of the tiedown chains during the test, photograph and document the problem(s). The test officer will notify SDDCTEA of the modifications required, and jointly decide if a retest is required.

5. ANALYSIS OF RESULTS.

In addition to the guidance provided in Part One, paragraphs 5.14 and 5.17, the following information is provided to assist in the evaluation of the test results. Apply any data relative to failure of a test item to meet the requirements of the materiel specifications to the test analysis, and consider related information such as:

- a. The test item fails this test if the test item, or any item that is attached to it, or that is included as an integral part of the test item, breaks free, loosens, or shows any sign of permanent deformation beyond specification tolerances. The test item also fails this test if the pass/fail criteria defined in paragraph 3.1b(9) of this Method are not met.
- b. The test item and its subassemblies must be operationally effective after the test.
- c. If tiedown securement items break or displace substantially, photograph and document the problem areas for evaluation of the procedures and materials used. The test officer and SDDCTEA jointly decide if any failed securement items require reconfiguring and, if so, whether a complete retest is required.
- d. Additional considerations:
 - (1) Loosening of restraints.
 - (2) Failure of attachments, creating a safety hazard.
 - (3) Shifting of materiel on the railcar.
 - (4) Failure of materiel.
 - (5) Structural failure.
 - (6) Fuel spills. Fuel spills are not acceptable and must be repaired and retested. Very slight spotting of a few drips of a residual fuel spill is not acceptable. Cause of spills must be identified and corrected/repared. Consult SDDCTEA to determine if a retest is required.

MIL-STD-810H
METHOD 526.2**6. REFERENCE/RELATED DOCUMENTS.****6.1 Referenced Documents.**

- a. "Rules for Loading Military Equipment and Materiel," AAR Open Top Loading Rules Manual, Section 6. (Procure copies from the Publications Department, Transportation Technology Center, Inc., P.O. Box 11130, 55500 DOT Road, Pueblo, CO 81001, (877) 999-8824 (toll free) or email: pupubs@aar.com.)
- b. Clay, H. W., Kirk, J. P. and S.P. Poynor, "Development of Rail Impact Shock Criteria for Cushioned Railcars," Shock and Vibration Symposium, October 2005. Shock & Vibration Exchange (SAVE), 1104 Arvon Road, Arvon, VA 23004.
- c. DoD Instruction 4540.07, "Operation of the DoD Engineering for Transportability and Deployability Program.", 19 February 2016
- d. SDDCTEA Modal Instruction 55-19, Tiedown Instructions for Rail Movements, Seventh Edition, July 2015, Military Surface Deployment and Distribution Command, Transportation Engineering Agency Website.
- e. Xue-lian Zheng, Li Xian-sheng, and Ren Yuan-yuan, "Equivalent Mechanical Model for Lateral Liquid Sloshing in Partially Filled Tank Vehicles," College of Traffic, Jilin University, October 2012.
- f. MIL-STD-1320D, DoD Standard Practice For Designing Unit Loads, Truckloads, Railcar Loads, and Intermodal Loads for Ammunition and Explosives.
- g. MIL-STD-209K, Lifting and Tiedown Provisions.

6.2 Related Documents.

- a. Schock, R. W. and W. E. Paulson, TRANSPORTATION A Survey of Shock and Vibration Environments in the Four Major Modes of Transportation, Shock and Vibration Bulletin #35, Part 5, February 1966. Shock & Vibration Exchange (SAVE), 1104 Arvon Road, Arvon, VA 23004.
- b. Ostrem, F. E., TRANSPORTATION AND PACKAGING A Survey of the Transportation Shock and Vibration Input to Cargo, Shock and Vibration Bulletin #42, Part 1, January 1972. Shock & Vibration Exchange (SAVE), 1104 Arvon Road, Arvon, VA 23004.
- c. Egbert, Herbert W. "The History and Rationale of MIL-STD-810 (Edition 2)," January 2010; Institute of Environmental Sciences and Technology, Arlington Place One, 2340 S. Arlington Heights Road, Suite 100, Arlington Heights, IL 60005-4516.
- d. Allied Environmental Conditions and Test Publication (AECTP) 400, Mechanical Environmental Tests (under STANAG 4370), Method 416.
- e. DoD Directive 4510.11, DoD Transportation Engineering, 23 Dec 2014.
- f. AR 70-47, Engineering for Transportability Program, 11 September 2012.
- g. MIL-STD-1366E, Transportability Criteria 31 Oct 2006.

(Copies of Department of Defense Specifications, Standards, and Handbooks, and International Standardization Agreements are available online at <https://assist.dla.mil>.)

Requests for other defense-related technical publications may be directed to the Defense Technical Information Center (DTIC), ATTN: DTIC-BR, Suite 0944, 8725 John J. Kingman Road, Fort Belvoir VA 22060-6218, 1-800-225-3842 (Assistance--selection 3, option 2), <http://www.dtic.mil/dtic/>; and the National Technical Information Service (NTIS), Springfield VA 22161, 1-800-553-NTIS (6847), <http://www.ntis.gov/>.

MIL-STD-810H
METHOD 527.2**METHOD 527.2**
MULTI-EXCITER TEST**CONTENTS**

<u>Paragraph</u>	<u>Page</u>
1. SCOPE	1
1.1 PURPOSE.....	1
1.2 APPLICATION	1
1.2.1 GENERAL DISCUSSION	1
1.2.2 TERMINOLOGY.....	2
1.3 LIMITATIONS.....	5
2. TAILORING GUIDANCE	5
2.1 SELECTING THE MET METHOD.....	5
2.1.1 EFFECTS OF THE MET ENVIRONMENT	5
2.1.2 SEQUENCE AMONG OTHER METHODS.....	6
2.2 SELECTING A PROCEDURE.....	6
2.2.1 PROCEDURE SELECTION CONSIDERATIONS	6
2.3 DETERMINE TEST LEVELS AND CONDITIONS	6
2.3.1 LABORATORY TEST DATA INPUT	7
2.3.1.1 CROSS-SPECTRAL DENSITY CONSIDERATIONS.....	7
2.3.1.2 GENERAL	7
2.3.2 LABORATORY TEST OUTPUT.....	7
2.4 TEST ITEM OPERATION	7
3. INFORMATION REQUIRED.....	7
3.1 PRETEST.....	7
3.2 DURING TEST.....	8
3.3 POST-TEST.....	8
4. TEST PROCESS	8
4.1 TEST FACILITY	8
4.2 CONTROLS	8
4.2.1 CALIBRATION.....	9
4.2.2 TOLERANCES.....	9
4.3 TEST INTERRUPTION	9
4.3.1 INTERRUPTION DUE TO LABORATORY EQUIPMENT MALFUNCTION.....	9
4.3.2 INTERRUPTION DUE TO TEST ITEM OPERATION FAILURE	9
4.3.3 INTERRUPTION DUE TO A SCHEDULED EVENT	10
4.3.4 INTERRUPTION DUE TO EXCEEDING TEST TOLERANCES.....	10
4.4 TEST SETUP.....	10
4.4.1 INSTRUMENTATION.....	10
4.4.2 PLATFORM INTEGRATION.....	11
4.4.3 SETUP ANALYSIS	11
4.5 TEST EXECUTION	11
4.5.1 PREPARATION FOR TEST.....	11
4.5.1.1 PRELIMINARY STEPS	12
4.5.1.2 PRETEST STANDARD AMBIENT CHECKOUT.....	12
4.5.2 PROCEDURE	12

MIL-STD-810H
METHOD 527.2

CONTENTS-Continued

<u>Paragraph</u>	<u>Page</u>
5. ANALYSIS OF RESULTS	13
5.1 PHYSICS OF FAILURE.....	14
5.2 QUALIFICATION TESTS.....	14
5.3 OTHER TESTS.....	14
6. REFERENCE/RELATED DOCUMENTS	14
6.1 REFERENCED DOCUMENTS.....	14
6.2 RELATED DOCUMENTS.....	15

FIGURES

FIGURE 527.2-1. SESA - SINGLE EXCITER VERTICAL AXIS TEST SETUP	3
FIGURE 527.2-2. MESA (IF CONTROL CONFIGURED FOR TWO EXCITER 1-DOF MOTION) OR MEMA (IF CONTROL AND MECHANICAL COUPLINGS CONFIGURED FOR TWO EXCITER 2-DOF MOTION)	3
FIGURE 527.2-3. MEMA - TRI-AXIAL EXCITER TEST SETUP (TRANSLATIONAL DEGREES-OF-FREEDOM).....	4

**METHOD 527.2 ANNEX A
ENGINEERING INFORMATION FOR MET TRANSDUCER PLACEMENT**

1. GENERAL PHILOSOPHY FOR A MET	A-1
2. REFERENCE POINT CONSIDERATIONS FOR MDOF TESTING	A-1
2.1 REFERENCE DATA CONSIDERATIONS	A-1
2.2 REFERENCE POINT KENMATICS.....	A-1

ANNEX A FIGURE

FIGURE 527.2A-1. BODY WITH n ACCELEROMETERS. PLACEMENTS.....	A-2
--	-----

**METHOD 527.2 ANNEX B
SYSTEM IDENTIFICATION FOR LINEAR TIME-INVARIANT MDOF SYSTEMS**

1. TRANSFER-FUNCTION ESTIMATIONS.....	B-1
2. SIGNAL TRANSFORMATION.....	B-1
3. CONTROL IMPLEMENTATION.....	B-1
3.1 SISO AUTO AND CROSS-SPECTRAL DEFINITIONS REVIEW	B-1
3.2 SISO TRANSFER FUNCTION AND COHERENCE FUNCTION DEFINITIONS REVIEW	B-2
3.3 MIMO AUTO-SPECTRA, CROSS-SPECTRA, AND INITIAL FUNCTION ESTIMATES	B-3
3.3.1 FREQUENCY DOMAIN TRANSFER FUNCTION RELATIONSHIP	B-3
3.3.2 KEY TRANSFER FUNCTION DERIVATIONS	B-4
3.3.3 KEY TRANSFER FUNCTION DERIVATIONS ALTERNATIVE.....	B-5
3.4 MIMO COHERENCE FUNCTIONS	B-6
3.4.1 ORDINARY COHERENCE.....	B-6
3.4.2 PARTIAL COHERENCE	B-7
3.4.3 MULTIPLE COHERENCE.....	B-7
3.5 DRIVE SIGNAL COMPENSATION	B-7

MIL-STD-810H
METHOD 527.2

CONTENTS-Continued

<u>Paragraph</u>	<u>Page</u>
METHOD 527.2 ANNEX C	
PROCEDURE I MET (TIME WAVEFORM REPLICATION (TWR) SPECIFIC)	
1. PROCEDURE I MET (TIME DOMAIN REFERENCE CRITERIA)	C-1
1.1 PREPROCESSING	C-1
2. ANALYSIS CONSIDERATIONS FOR A PROCEDURE I MET	C-1
2.1 ADDRESSING TRANSLATIONAL MOTION	C-1
2.2 ADDRESSING ANGULAR MOTION	C-1
3. TEST TOLERANCES FOR A PROCEDURE I MET	C-2
3.1 COMPOSITE (GLOBAL) ERROR DISCUSSION FOR PROCEDURE I	C-2
3.2 GLOBAL RMS ERROR	C-2
3.3 GLOBAL ASD ERROR.....	C-4
3.4 GLOBAL SRS ERROR.....	C-6
METHOD 527.2 ANNEX D	
PROCEDURE II MET (SPECTRAL DENSITY MATRIX (SDM) SPECIFIC)	
1. PROCEDURE II MET (FREQUENCY DOMAIN REFERENCE CRITERIA)	D-1
1.1 PREPROCESSING	D-1
2. ANALYSIS CONSIDERATIONS FOR A PROCEDURE II MET	D-1
2.1 MESA AND MEMA SPECIFICATION PARAMETERS	D-1
2.1.1 CROSS SPECTRAL DENSITY STRUCTURE	D-2
2.2 CONTROL HIERARCHY	D-2
2.2.1 MEASURED DATA AVAILABLE.....	D-2
2.2.2 MEASURED DATA NOT AVAILABLE.....	D-2
2.2.3 USE OF 1-DOF REFERENCES.....	D-3
3. TEST TOLERANCES FOR A PROCEDURE II MET.....	D-3
3.1 COMPOSITE (GLOBAL) ERROR DISCUSSION FOR PROCEDURE II.....	D-3
ANNEX D TABLES	
TABLE 527.2D-I. REFERENCE CRITERIA FOR A 2-DOF LINEAR MOTION RANDOM MET.....	D-1
TABLE 527.2D-II. REFERENCE CRITERIA FOR A 3-DOF LINEAR MOTION RANDOM MET.....	D-1
METHOD 527.2 ANNEX E	
LABORATORY VIBRATION TEST SCHEDULE DEVELOPMENT	
FOR MULTI-EXCITER APPLICATIONS	
1. SCOPE	E-1
2. FACILITIES AND INSTRUMENTATION	E-1
2.1 FACILITIES	E-1

MIL-STD-810H
METHOD 527.2**CONTENTS-Continued**

<u>Paragraph</u>	<u>Page</u>
2.2 INSTRUMENTATION	E-1
3. REQUIRED TEST CONDITIONS.....	E-1
3.1 TEST CONFIGURATIONS	E-1
3.1.1 BASIC REPRESENTATION OF A MIMO SYSTEM	E-2
3.1.2 GENERALIZED REPRESENTATION OF A MIMO SYSTEM	E-2
3.2 GENERALIZED MDOF VIBRATION CONTROL DISCUSSION.....	E-3
4. TEST PROCEDURES	E-4
4.1 DEVELOPMENT OF MISSION OR LIFETIME SCENARIO	E-4
4.2 LIMITATIONS.....	E-4
4.3 FIELD DATA ACQUISITION	E-5
4.3.1 INSTRUMENTATION	E-5
4.4 USE OF RIGID BODY MODES	E-5
4.4.1 ACCELERATION (INPUT) TRANSFORMATION	E-5
4.4.1.1 ACCELERATION (INPUT) TRANSFORMATION DERIVATION	E-6
4.4.1.2 EQUATION 4.1	E-6
4.4.2 DRIVE (OUTPUT) TRANSFORMATION	E-7
4.4.2.1 DRIVE (OUTPUT) TRANSFORMATION DERIVATION	E-8
4.5 DATA ANALYSIS	E-9
4.5.1 PHASE AND COHERENCE BASED REPRESENTATIONS OF CSD TERMS	E-10
4.5.2 POSITIVE DEFINITE SDM CONSIDERATIONS	E-10
4.5.3 DATA COMPRESSION.....	E-11
4.5.4 LIMITING STRATEGIES	E-12
4.5.5 MINIMUM DRIVE CONSIDERATIONS.....	E-12
4.5.5.1 INDEPENDENT DRIVES.....	E-12
4.6 INDEPENDENT REFERENCES	E-13
4.7 RECOMMENDED PRACTICES SUMMARY	E-14
5. DATA REQUIRED	E-15
5.1 REFERENCE SDM DEVELOPMENT.....	E-15
5.1.1 SDM ENSEMBLE CSD CHARACTERISTICS	E-15
5.2 TEST TOLERANCE RECOMMENDATIONS.....	E-16
5.3 LABORATORY DATA	E-16
6. MDOF VSD METHODS	E-16
6.1 OPTIONS CONSIDERED	E-16
6.1.1 METHOD I.....	E-16
6.1.2 METHOD II.....	E-18
6.2 EXAMPLE	E-19
6.3 CONCLUDING REMARKS	E-25
APPENDIX A GLOSSARY	E-27
APPENDIX B ABBREVIATIONS	E-29
APPENDIX C NOMENCLATURE.....	E-31
APPENDIX D MATRIX ALGEBRA REVIEW	E-33
APPENDIX E REFERENCES	E-37

MIL-STD-810H
METHOD 527.2**METHOD 527.2**
MULTI-EXCITER TEST

NOTE: Tailoring is required. Select methods, procedures, and parameter levels based on the tailoring process described in Part One, paragraph 4, and Annex C. Apply the general guidelines for laboratory test methods described in Part One, paragraph 5 of this standard.

Although various forms of multi-exciter test (MET) have been discussed in the technical literature and conducted in the laboratory dating back over multiple decades, there are still many issues regarding standardization of laboratory MET. In this early version of the Multi-Exciter Test Method, the intent is to introduce the basic definitions and structure of a laboratory-based multi-exciter test. MET hardware and control algorithms have continued to improve at an impressive rate recently, and MET is becoming more common in many dynamic test facilities. Feedback from the growing MET user community is highly encouraged, will be reviewed, and will play a major role in improving this Method.

Organization. The main body of this Method is arranged similarly to that of other methods of MIL-STD-810. A considerable body of supplementary information is included in the Annexes. Reference citations to external documents are at the end of the main body (paragraph 6.1). The Annexes are structured as follows:

ANNEX A - ENGINEERING INFORMATION FOR MET TRANSDUCER PLACEMENT

ANNEX B - SYSTEM IDENTIFICATION FOR LINEAR TIME INVARIANT MDOF SYSTEMS

ANNEX C - PROCEDURE I MET (TIME WAVEFORM REPLICATION (TWR) SPECIFIC)

ANNEX D - PROCEDURE II MET (SPECTRAL DENSITY MATRIX (SDM) SPECIFIC)

**ANNEX E - LABORATORY VIBRATION TEST SCHEDULE DEVELOPMENT FOR
MULTI-EXCITER APPLICATIONS**

1. SCOPE.

1.1 Purpose.

Multi-exciter test methodology is performed to demonstrate, or provide a degree of confidence if multiple test items are considered, that materiel can structurally and functionally withstand a specified dynamic environment, e.g., stationary, non-stationary, or of a shock nature, that must be replicated on the test item in the laboratory with more than one motion degree-of-freedom. The laboratory test environment may be derived from field measurements on materiel, or may be based on an analytically-generated specification.

1.2 Application.

- a. **General.** Use this Method for all types of materiel except as noted in Part One, paragraph 1.3, and as stated in paragraph 1.3 below. For combined environment tests, conduct the test in accordance with the applicable test documentation. However, use this Method for determination of dynamic test levels, durations, data reduction, and test procedure details.
- b. **Purpose of Test.** The test procedures and guidance herein are adaptable to various test purposes including development, reliability, qualification, etc.
- c. **Dynamics Life Cycle.** Table 514.8-I provides an overview of various life cycle situations during which some form of vibration (stationary or non-stationary) may be encountered, along with the anticipated platform involved.

1.2.1 General Discussion.

Use this Method to demonstrate that the materiel of interest can structurally and functionally withstand a specified dynamic environment that is defined in more than a single-degree-of-freedom (SDOF) motion; i.e., in multiple-degree-

MIL-STD-810H
METHOD 527.2

of-freedom (MDOF) motion. Establishing confidence intervals may also be of interest if multiple like items are under test. Specification of the environment may be through a detailed summary of measured field data related to the test materiel that entails more than one degree-of-freedom, or analytical generation of an environment that has been properly characterized in MDOF. In general, specification of the environment will include several degrees of freedom in a materiel measurement point configuration, and testing of the materiel in the laboratory in a SDOF mode is considered inadequate to properly distribute vibration energy in the materiel in order to satisfy the specification. As a result of the increased complexity of application of MET over multiple application of SDOF single-exciter testing (SET), an analyst, after careful review of the available data and specification, will need to provide rationale for selection of this Method. Methods 514.8, 516.8, 519.8, and 525.2 provide guidance in developing the rationale and requirement for MET.

Reasons for selection of MET over SET may include the following.

- a. MET provides a distribution of vibration or shock energy to the materiel in more than one axis in a controlled manner without relying on the dynamics of the materiel for such distribution.
- b. MET may be selected when the physical configuration of the materiel is such that its slenderness ratio is high, and SET must rely on the dynamics of the materiel to distribute energy.
- c. For large and heavy test materiel, more than one exciter may be necessary to provide sufficient energy to the test item.
- d. MET allows more degrees-of-freedom in accounting for both the impedance matches and the in service boundary conditions of the materiel.

1.2.2 Terminology.

Several terms need to be carefully defined for contrasting MET with SET. The term “test configuration” used in this document will refer to the totality of description for laboratory testing including the sources of excitation, test item fixturing, and orientation. In either testing configuration, distinction must be made between excitation measurement in a vector axis of excitation, and measurement on the test item in either the vector axis of excitation or in another vector different from the vector axis of excitation. Generally, to avoid confusion in specification and reporting, the vector directions of excitation and measurement must be specified in terms of a single laboratory inertial frame of reference related to the test configuration. In addition, it is helpful to specify the test item geometrical configuration along with the dynamic properties such as mass moments of inertia relative to the single laboratory inertial frame of reference.

- a. **Single-Degree-of-Freedom (SDOF)** – motion defined by materiel movement along or about a single axis whose description requires only one coordinate to completely define the position of the item at any instant.
- b. **Multi-Degree-of-Freedom (MDOF)** – motion defined by test item movement along or about more than one axis whose description requires two or more coordinates to completely define the position of the item at any instant.
- c. **Single-Axis (SA)** - excitation or response measurement in a unique single vector direction (linear or rotational). For rotational axis, the vector direction is perpendicular to the plane of rotation of the exciter or test item. Figure 527.2-1 displays a single-axis input in the vertical direction to an extended structure.
- d. **Multi-Axis (MA)** – excitation or response measurement that requires more than one unique vector for description. Refer to Figures 527.2-2 and 527.2-3 for MA examples of both two-axis and three-axis inputs to a common structure.
- e. **Single-Exciter/Single-Axis (SESA)** - application of a single exciter providing dynamic input to the test item in a single vector direction. All SET configurations are SESA by definition.
- f. **Multi-Exciter/Single-Axis (MESA)** – application of multiple exciters providing dynamic input to the test item in a single vector direction. For example, extended materiel might require excitation at the forward and aft end in a single vector axis as illustrated in Figure 527.2-2. If the definition of excitation requires more than a single vector, refer to the MEMA definition.

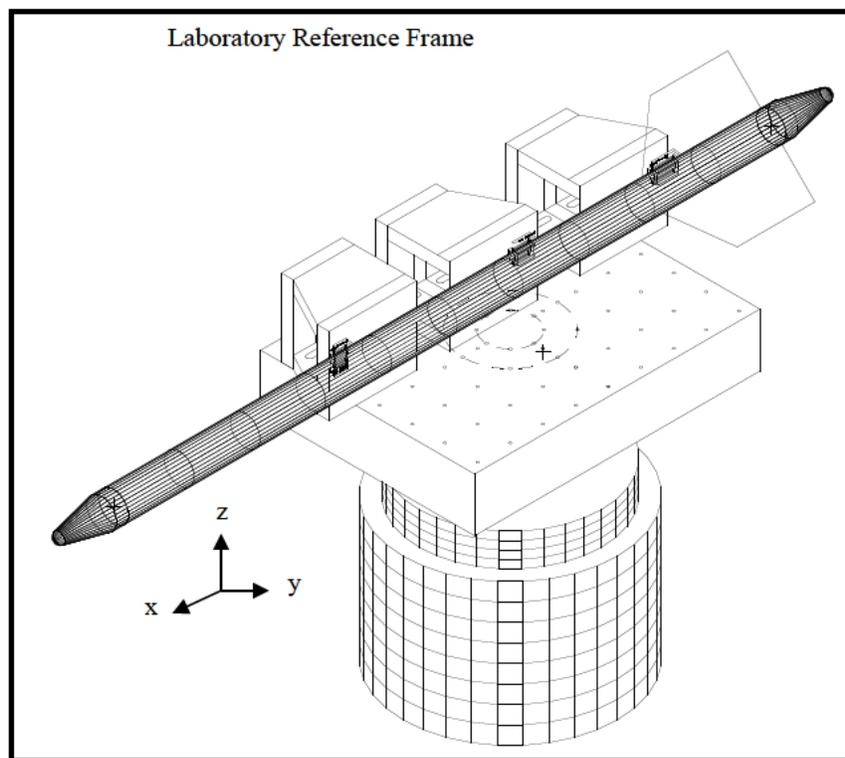
MIL-STD-810H
METHOD 527.2

Figure 527.2-1. SESA - Single exciter vertical axis test setup.

Figure 527.2-2 illustrates a two-exciter application. Note that the system would require appropriate bearing assemblies to allow a pure rotational MESA or combined linear and rotational MEMA motion.

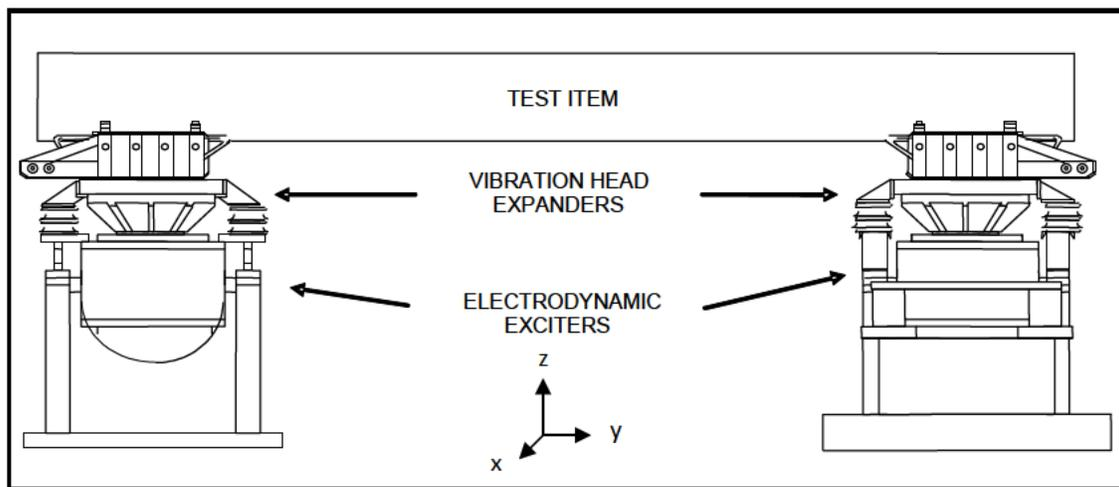


Figure 527.2-2. MESA (if control configured for two exciter 1-DOF motion) or MEMA (if control and mechanical couplings configured for two exciter 2-DOF motion).

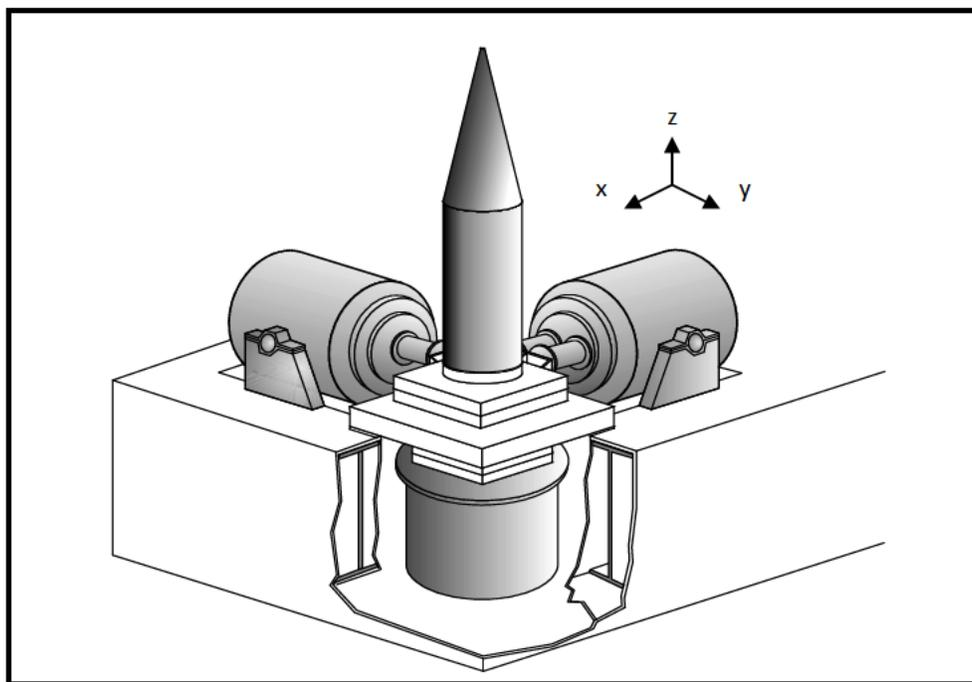
MIL-STD-810H
METHOD 527.2

Figure 527.2-3. MEMA - Tri-axial exciter test setup (Translational Degrees-of-Freedom).

- g. **Multi-Exciter/Multi-Axis (MEMA)** - Application of multiple exciters providing dynamic input to the test item in a way that requires more than a single vector for complete description of excitation and measurement. Figure 527.2-3 displays a three exciter three axis test. Three axes vertical, transverse, and longitudinal are required to describe the test. Note that many multi-axis test platform configurations have been built in recent years. Common 6 exciter examples are the hexapod (Stewart Platform), MAST, and Team Cube. There are also over-determined actuated systems consisting of more than 6 exciters. In each case, the dynamic properties vary between designs, and must be considered in the design of a MET.
- h. **Single-Input/Single-Output (SISO)** - refers to input of a single drive signal to an exciter system in an SDOF configuration and a single measured output from the fixture or test item in an SDOF configuration.
- i. **Single-Input/Multiple-Output (SIMO)** - refers to input of a single drive signal to an exciter system in a SDOF configuration, and multiple measured outputs from the fixture or test item in a MDOF configuration. In general, for specification purposes the dynamic behavior of the test item will not be assumed to contribute to the output DOF, i.e., measured rotation of an extended test item that is being excited in a cantilever mode will still basically be considered as a SET with linear acceleration characterizing the output.
- j. **Multiple-Input/Single-Output (MISO)** - refers to input of a multiple drive signals to an exciter system configuration in a MDOF configuration, and a single measured output from the fixture or test item in a SDOF configuration. This terminology is most used in measurement data processing where the single output is a composite of measurements from multiple inputs.
- k. **Multiple-Input/Multiple-Output (MIMO)** - refers to input of multiple drive signals to an exciter system configuration in a MDOF configuration, and multiple measured outputs from the fixture or test item in a MDOF configuration. It is important to note that generally there is no one-to-one correspondence between inputs and outputs, and the number of inputs and number of outputs may be different.

In the paragraphs to follow, generally only the terms MESA and MEMA will be used, however, for processing measurement data the terms SISO, SIMO, MISO, and MIMO are standard (paragraph 6.1, references a and c).

MIL-STD-810H
METHOD 527.2**1.3 Limitations.**

This Method addresses very general testing configurations for applying excitation in multiple axes to materiel. Generally, field deployed materiel has boundary (or impedance) conditions that are very difficult and often cost prohibitive to replicate in laboratory testing. The overall goal of a MET is to achieve a distribution of materiel excitation energy that approaches that appearing during in-service deployment, while minimizing the difference between in-service and laboratory boundary conditions. Fixturing design limitations and/or other physical constraints may limit application of in-service environment in the laboratory. Also, in-service measurements may not be adequate to specify the laboratory test configuration. As always, engineering analysis and judgment will be required to ensure the test fidelity is sufficient to meet the test objectives.

The following limitations also apply to this Method:

- a. It does not address aspects of vendor-supplied software control strategy for a MET.
- b. It does not address advantages or disadvantages of Procedure I and Procedure II MET as defined in paragraph 2.2. The state of the art in a MET is not such that a comprehensive comparison can be made at this time.
- c. It does not address optimization techniques of the laboratory test configuration relative to distribution of the excitation energy within the test item.
- d. It does not address technical issues related to axes of excitation and materiel mass and product moments of inertia. Nor does it address the need for specialized software for optimizing the axes of excitation with respect to mass and products of inertia.
- e. It generally does not provide specific test tolerance information that is highly dependent on the (1) test objective, (2) test laboratory measurement configuration, and (3) vendor software control strategy.
- f. It does not discuss, in detail, the potential for efficiencies and efficacies of a MET over SET, leaving this as a part of specification of MET peculiar to the in-service measured environment.
- g. It does not discuss optimum in-service measurement configuration factors consistent with a MET.
- h. It assumes that excitation is provided mechanically through electro-dynamic or servo-hydraulic exciters, and does not consider combined acoustic (refer to Method 523.4) or pneumatic induced modes of excitation.

2. TAILORING GUIDANCE.**2.1 Selecting the MET Method.**

After examining requirements documents and applying the tailoring process in Part One of this Standard to determine where significant excitation energy distribution effects are foreseen in the life cycle of the materiel, or substantial testing cost savings might be achieved by employing MET strategy, use the following to confirm the need for this Method, and to place it in sequence with other Methods.

2.1.1 Effects of the MET Environment.

In general, all in-service measured environments require multiple axis response measurements for complete description. Generally, a MET will distribute excitation energy to the test item and minimize the effects of in-service boundary conditions. The following is a partial list of effects to materiel that may be better replicated in the laboratory under a MET than a SET.

- a. Fatigue, cracking, and rupture sensitive to multi-axis excitation.
- b. Deformation of materiel structure, e.g., protruding parts.
- c. Loosening of seals and connections.
- d. Displacement of components.
- e. Chafing of surfaces with single-axis design.
- f. Contact, short-circuiting, or degradation of electrical components.
- g. Misalignment of materiel components (e.g., optical).

MIL-STD-810H
METHOD 527.2**2.1.2 Sequence Among Other Methods.**

- a. General. See Part One of this Standard, paragraph 5.5.
- b. Unique to this Method. Generally, a MET-specified environment may occur at any time during the life cycle of the materiel, and may be interspersed among specially designed multiple axis SET environments, e.g., shock. Perform tests representing critical end-of-mission environments last. For most tests, this can be varied if necessary to accommodate test facility schedules, or for other practical reasons.

2.2 Selecting a Procedure.

Two basic test procedures are defined under MET. The MESA or MEMA procedures may be used in replication of either a field measured materiel response or an analytically prescribed multi-axis environment. The two basic test procedures are summarized as follows:

- a. Procedure I – Time Domain Reference Criteria. This MET Procedure is an extension to the SESA Time Waveform Replication (TWR) techniques addressed in Method 525.2. As with the case for SESA, the time histories measured or synthesized for a MEMA TWR test are not limited to stationary Gaussian structures.
- b. Procedure II – Frequency Domain Reference Criteria. This MET Procedure is an extension to the SESA Spectral based vibration control techniques addressed in Method 514.8. As with the case for SESA, the time histories synthesized for a MEMA random test will be stationary and Gaussian in structure.

2.2.1 Procedure Selection Considerations.

Based on the test data requirements, determine if this Method is applicable. In particular, determine if there is carefully measured and properly processed materiel field measurement configuration information available in the form of band-limited time histories or auto- and cross-spectral density estimates as appropriate to be consistent with the laboratory MET configuration and vibration control system vendor software specification requirements. Basic consideration is given to an environment in a single-axis requiring multiple exciters, or an environment in multiple axes requiring multiple exciters. Generally, the MEMA procedure exceeds the complexity of the MESA procedure, so attempts should be made to minimize the test procedure complexity to the degree possible.

Materiel in-service use, along with significant environment energy distribution effects, should assist in procedure selection. One major consideration, in selection of Procedure I, is the ability to address scenarios in which the reference signal statistics are not stationary and Gaussian. Procedure II should be considered in the event that the reference data are stationary, and the ensemble of signals representing the service life may be reasonably represented by a Gaussian probability density function, and/or when time compression techniques are to be employed. Refer to the guidance provided in paragraph 4.2.2.1 of Method 514.8 regarding manipulation of kurtosis to address non-Gaussian behavior.

2.3 Determine Test Levels and Conditions.

Generally, both procedures require in-service measured response data. Procedure I will require multiple time traces to serve as the test references, and Procedure II will require the measured data to have been processed into auto- and cross-spectral density estimates in determining test levels and conditions. However, it is also possible that a MET procedure may rely on analytically specified time histories or auto- and cross-spectral density information.

2.3.1 Laboratory Test Data Input.

Acceptable engineering practice as described in paragraph 6.1, reference e, should be used to provide in-service materiel response measurement data that may be used directly in specifying one of the procedures for a MET, or may be inferred as representative of an environment that may be indirectly specified for one of the procedures for a MET. In either direct or indirect use of measurements, particular measurements are made relatively independent of materiel structure or in “zones” of the materiel that are insensitive to local conditions. It is also assumed that in-service, materiel response measurements correspond with materiel response measurements to be made in the laboratory under a MET. It is essential that the mass properties of the materiel be determined, including center-of-gravity and the mass and product moments of inertia. Whenever practical, obtain a modal survey of both the in-service and the laboratory materiel configurations. This will allow assessment of the overall dynamic characteristics of the two configurations, in addition to identifying any non-linearities as a result of materiel joints, etc. Proper interpretation of the normal mode analysis will assist in determining an optimum laboratory test configuration based on in-service measurements. Even a simple mass/stiffness analytical model will greatly assist in establishing an optimum laboratory test

MIL-STD-810H
METHOD 527.2

configuration. Give careful attention to the form and nature of the input information into the MET vendor supplied software.

2.3.1.1 Cross-Spectral Density Considerations.

In the conduct of a MET, the definition of the cross-spectral density (CSD) terms play a major role in the degree to which the characteristics of the laboratory motion correlates to the field measurements in terms of both joint spectral and temporal characteristics. In the case of Procedure I (time domain reference) the CSD information is preserved within the individual time histories to be used as reference criteria. In the case of Procedure II (frequency domain reference) the CSD terms need to be specified based on CSD estimates computed from field data. Annex D addresses the control of CSD terms in more detail.

2.3.1.2 General.

Identify the test conditions, particularly with respect to temperature conditions. Exercise extreme care in consideration of the details in the tailoring process. Base these selections on the requirements documents, the Life Cycle Environmental Profile, and information provided with this procedure.

2.3.2 Laboratory Test Output.

In addition to the considerations in paragraph 2.3.1, the test item may be instrumented at locations other than the points of MET "control," and these points are generally termed per discussion in paragraph 2.3.1 "monitoring" points. Such measurement points may be useful for other purposes such as analytical modeling of materiel and materiel components. Such measurement information and its use will not be discussed further here.

2.4 Test Item Operation.

Whenever practical, ensure test items are active and functioning during vibration tests. Monitor and record achieved performance. Obtain as much data as possible that defines the sensitivity of the materiel to vibration. Where tests are conducted to determine operational capability while exposed to the environment, operate the test item. In other cases, operate the test item where practical. Operation during transportation will not be possible in almost all cases. Also, there are cases where the operational configuration varies with mission phase, or where operation at high levels of vibration may not be required, and may be likely to result in damage.

3. INFORMATION REQUIRED.

The following minimal information is required to conduct and document dynamic tests adequately. Tailor the lists to the specific circumstances, adding or deleting items as necessary. Performing fixture and materiel modal surveys is highly recommended. These data are useful in evaluating test results, and in evaluating the suitability of materiel against changing requirements or for new applications. These data can be particularly valuable in future programs where the major emphasis will be to use existing materiel in new applications. (When modal survey is ruled out for programmatic reasons, a simple resonance search can sometimes provide useful information).

3.1 Pretest.

The following information is required to adequately conduct a MET.

- a. General. Information listed in Part One, paragraphs 5.7 and 5.9 of this Standard, and in Part One, Annex A, Task 405 of this Standard.
- b. Specific to this Method.
 - (1) Selection of test procedure and test system (test item/platform configuration) detailed information including:
 - (a) Control sensor locations for control time traces (refer to Annex A for MET specific considerations).
 - (b) Reference time histories for a Procedure I MET, or reference ASD & CSD for a Procedure II MET.
 - (c) Monitor/limit sensor locations (if any).
 - (d) Levels of pre-test acceptable to obtain appropriate shaker system compensation.

MIL-STD-810H
METHOD 527.2

- (e) Criteria for satisfaction of the test, including previously agreed MET tolerance limits.
- (2) Ability of overall system to replicate either a measured materiel environment or an analytically specified materiel environment under a MET, including bandlimited input and the temperature effects (if any).
- c. Tailoring - Necessary variations in the basic test parameters/testing materials to accommodate Life Cycle Environmental Profile (LCEP) requirements and/or facility limitations.

3.2 During Test.

Collect the following information while conducting the test.

- a. General. Information listed in Part One, paragraph 5.10, and in Annex A, Tasks 405 and 406 of this Standard.
- b. Specific to this Method.
 - (1) Capture of the appropriately processed control time trace information in digital form for comparison with the specification. Compute key time domain engineering unit (EU) specific metrics such as rms versus time and key spectral metrics such as auto-spectral and cross-spectral density estimates, and ensure compliance with agreed-upon tolerances.
 - (2) Capture of the appropriately processed monitor/limit time trace information in digital form.
 - (3) Recording of the number of exposures and the duration of the dynamic environments.
 - (4) Log of auxiliary environmental conditions such as temperature.
 - (5) Log of any out of tolerance conditions relative to the control measurement points.
 - (6) Log of materiel functional failure.

3.3 Post-Test.

The following post-test data shall be included in the test report.

- a. General. Information listed in Part One paragraph 5.13, and in Annex A, Task 406 of this Standard.
- b. Specific to this Method.
 - (1) Duration of exposure of the materiel to the dynamic MET environment.
 - (2) Any data measurement anomalies, e.g., high instrumentation noise levels, loss of sensor response.
 - (3) Status of the test materiel/fixture. In particular, any structural or functional failure of the test materiel/fixture.
 - (4) Status of measurement system after each test.
 - (5) Any changes from the original test plan.

4. TEST PROCESS.

Tailor the following sections as appropriate for the individual contract or program.

4.1 Test Facility.

The specialized nature of a MET requires use of a test facility that includes proven MET capability, fixture(s) for mounting the test materiel, and appropriate equipment for recording the response of the test item at the specified control and monitor locations. In addition, the test facility will have expertise necessary to appropriately configure the test according to the form of test materiel as outlined in paragraph 2.2.1. Ensure the exciter control has appropriately validated vendor supplied MET hardware and software.

4.2 Controls.

The accuracy in providing and measuring shock and vibration environments is highly dependent on fixtures and mountings for the test item, the measurement system, and the exciter control strategy. Ensure all instrumentation considerations are in accordance with the best practices available (see paragraph 6.1, references d and e). Careful

MIL-STD-810H
METHOD 527.2

design of the test set up, fixtures, transducer mountings, and wiring, along with good quality control will be necessary to meet the tolerances of paragraph 4.2.2 below.

4.2.1 Calibration.

Ensure the excitation apparatus, all transducers, signal conditioning equipment, independent measurement systems, and the vibration control system are calibrated for conformance with the specified test requirement. Careful design of the test set up, fixtures, transducer mountings and wiring, along with good quality control will be necessary to meet the tolerances of paragraph 4.2.2 below.

4.2.2 Tolerances.

The question of reasonable tolerances in a MET is not simple for either MET procedure. Guidelines for establishing test tolerances for a Procedure I MET are discussed in Annex C, and tolerances for a Procedure II MET are discussed in Annex D. Due to the unique factors associated with a MET, test metrics will often need to be addressed on a test by test basis. It is critical that the test objectives be clearly understood prior to establishing test tolerances, and that the metrics are carefully documented prior to conduct of the test.

4.3 Test Interruption.

Test interruptions can result from multiple situations. The following paragraphs discuss common causes for test interruptions, and recommended paths forward for each. Recommend test recording equipment remain active during any test interruption if the excitation equipment is in a powered state.

4.3.1 Interruption Due To Laboratory Equipment Malfunction.

- a. General. See Part One, paragraph 5.11, of this Standard.
- b. Specific to this Method. When interruptions are due to failure of the laboratory equipment, analyze the failure to determine root cause. It is also strongly advised that both control and response data be evaluated to ensure that no undesired transients were imparted to the test item during the test equipment failure. If the test item was not subjected to an over-test condition as a result of the equipment failure, repair the test equipment or move to alternate test equipment and resume testing from the point of interruption. If the test item was subjected to an over-test condition as a result of the equipment failure, immediately notify the test engineer or program engineer responsible for the test item. Conduct a risk assessment based on factors such as level and duration of the over-test event, spectral content of the event, cost and availability of test resources, and analysis of test specific issues to establish the path forward. See Method 514.8, Annex A, paragraph 2.1 for descriptions of common test types, and a general discussion of test objectives.

4.3.2 Interruption Due To Test Item Operation Failure.

Failure of the test item(s) to function as required during operational checks presents a situation with several possible options. Failure of subsystems often has varying degrees of importance in evaluation of the test item. Selection of options a through c below will be test specific.

- a. The preferable option is to replace the test item with a “new” item and restart the entire test.
- b. An alternative is to replace/repair the failed or non-functioning component or assembly with one that functions as intended, and restart the entire test. Conduct a risk analysis prior to continuing since this option places an over-test condition on the entire test item except for the replaced component. If the non-functioning component or subsystem is a line replaceable unit (LRU) whose life-cycle is less than that of the system test being conducted, proceed as would be done in the field by substituting the LRU, and continue from the point of interruption.
- c. For many system level tests involving either very expensive or unique test items, it may not be possible to acquire additional hardware for re-test based on a single subsystem failure. For such cases, a risk assessment should be performed by the organization responsible for the system under test to determine if replacement of the failed subsystem and resumption of the test is an acceptable option. If such approval is provided, the failed component should be re-tested at the subcomponent level.

MIL-STD-810H
METHOD 527.2

NOTE: When evaluating failure interruptions, consider prior testing on the same test item and any consequences of such.

4.3.3 Interruption Due To A Scheduled Event.

There are often situations in which scheduled test interruptions will take place. For example, in a tactical transportation scenario, the payload may be re-secured to the transport vehicle periodically (i.e., tie-down straps may be re-secured at the beginning of each day). Endurance testing often represents a lifetime of exposure; therefore it is not realistic to expect the payload to go through the entire test sequence without re-securing the tie-downs as is done in a tactical deployment. Many other such interruptions, to include scheduled maintenance events, are often required over the life-cycle of materiel. Given the cumulative nature of fatigue imparted by dynamic testing, it is acceptable to have test interruptions that are correlated to realistic life-cycle events. All scheduled interruptions should be documented in the test plan and test report.

4.3.4 Interruption Due To Exceeding Test Tolerances.

Exceeding the test tolerances defined in paragraph 4.2.2, or a noticeable change in dynamic response may result in a manual operator initiated test interruption or an automatic interruption when the tolerances are integrated into the control strategy. In such cases, check the test item, fixturing, and instrumentation to isolate the cause.

- a. If the interruption resulted from a fixturing or instrumentation issue, correct the problem and resume the test.
- b. If the interruption resulted from a structural or mechanical degradation of the test item, the problem will generally result in a test failure, and a requirement to re-test unless the problem is allowed to be corrected during testing. If the test item does not operate satisfactorily, follow the guidance in paragraph 4.3.2 for test item failure.

4.4 Test Setup.

4.4.1 Instrumentation.

Various sensor types can be used in a MET setup and used to establish the need for a MET. In general, and used in examples throughout this document, acceleration will be the quantity measured to establish the specification for the procedure. Processed sensor measurement information from the lab environment should correspond to processed measurement information made in the field. This is ideally accomplished by mounting the test item accelerometer in the same location as that on the field measurement materiel from which the measured information was extracted. In the MDOF case, instrumentation location and polarity become critical test parameters (refer to Annex A). To maintain proper phase relationships between channels, a synchronous sample and hold analog to digital converter (A/D) is recommended. When possible, recommend laboratory and field data acquisition and instrumentation be the same. Otherwise, it may be necessary to precondition reference data prior to conduct of a laboratory test.

Calibrate all measurement instrumentation to traceable national calibration standards (see Part One, paragraph 5.3.2). The measurement device and its mounting will be compatible with the requirements and guidelines provided in paragraph 6.1, reference e.

- a. Accelerometer. In the selection of any transducer, one should be familiar with all parameters provided on the associated specification sheet. Key performance parameters for an accelerometer follow:
 - (1) Frequency Response: A flat frequency response within ± 5 percent across the frequency range of interest is required.
 - (2) Transverse sensitivity should be less than or equal to 5 percent.
 - (3) Nearly all transducers are affected by high and low temperatures. Understand and compensate for temperature sensitivity deviation as required. Temperature sensitivity deviations at the test temperature of interest should be no more than $\pm 5\%$ relative to the temperature at which the transducer sensitivity was established.
 - (4) Base Strain sensitivity should be evaluated in the selection of any accelerometer. Establishing limitations on base strain sensitivity is often case specific based upon the ratio of base strain to anticipated translational acceleration.

MIL-STD-810H
METHOD 527.2

- (5) High sensitivity accelerometers are recommended when linear accelerometers are employed to make rotational motion estimates.
- b. Other measurement devices. Any other measurement devices used to collect data must be demonstrated to be consistent with the requirements of the test.

4.4.2 Platform Integration.

- a. Test Fixture Design. Observe standard shock and vibration fixture design practices with regard to frequency response and the ability to withstand the reaction forces with consideration of potentially high loads generated during MEMA tests as a result of the accelerations applied simultaneously in multiple degrees of freedom.
- b. Test Configuration. Both MESA and MEMA tests require that the test configuration be restrained in all degrees of freedom that are not controlled by the exciter, and released in all degrees of freedom that are. A kinematic assessment of the setup is recommended to assist in the selection of the proper couplings, bearings, etc., to ensure that improper loads are not transferred to the test item through the controlled application of the test, as well as the potentially uncontrolled motion of the exciters.

4.4.3 Setup Analysis

In general, because of impedance mismatches and boundary condition effects, differences between the field and laboratory environments will exist. Such differences between the laboratory measured and test specified information may require further analysis with respect to the original field data and payload dynamics to determine if the differences are relevant to the test objectives.

- a. Rudimentary analysis to ensure the test tolerances are met is usually performed within the MET software and control strategy. Laboratory personnel should consult the vendor-supplied MET control system documentation, and clearly understand the determination of these test tolerances. In most cases this will require direct contact with the vendor of the MET system. At the time of this initial publication, common examples of analysis techniques that are performed during a MET include computation of EU-rms versus time, ASD, CSD, peak-detection, and histograms.
- b. More extensive data analysis can be performed to examine the significance of test tolerance deviations with off-line specialized software. Refer to Method 525.2, Annex B for Procedure I analysis methods, and paragraph 6.1, references d and e for a variety of detailed analysis techniques for random data applicable for Procedures I and II.

4.5 Test Execution.**4.5.1 Preparation for Test.**

Carefully examine the reference time histories or specified auto- and cross-spectral information for validity. Ensure the test specification is band-limited according to the band limits of the shaker system. In particular, it may be necessary to remove any high amplitude low frequency components that will cause an over-travel condition for the shaker control system or result in velocity limit violation. In the event the reference data must be modified to address exciter system limitations, care must be exercised to ensure the intent of the test is not compromised; and the modifications must be documented and approved by the responsible test officer. Most MET systems do provide for such exciter system limit checks; however, the feasibility of exciter reproduction relative to cross-spectral information is generally not checked.

Characterize the materiel to be tested. For example:

- a. Dynamically flexible structure with a varying length/diameter ratio.
- b. Dynamically stiff structure with flexible appendages.
- c. Dynamically/geometrically asymmetric structure.
- d. Materiel in shipping or storage containers with pursuant materiel/container isolation.

If the test item is unique and must not be degraded before laboratory testing, test a dynamic simulation item that represents the dynamic properties of the materiel to be tested to ensure the MET can be properly compensated. Such a preliminary test will allow specification and refinement of the control strategy, including selection of control measurement points. It may also allow specification of the overall exciter configuration for optimizing the test strategy.

MIL-STD-810H
METHOD 527.2

4.5.1.1 Preliminary Steps.

Before starting a test, review pretest information in the test plan to determine test details (procedure(s), test item configuration(s), levels, durations, vibration exciter control strategy, failure criteria, test item operational requirements, instrumentation requirements, facility capability, fixture(s), etc.).

- a. Select the appropriate MET configuration and associated fixturing.
- b. Select the appropriate data acquisition system (e.g., instrumentation, cables, signal conditioning, recording, and analysis equipment).
- c. Operate vibration equipment without the test item installed to confirm proper operation.
- d. Ensure the data acquisition system functions as required.

4.5.1.2 Pretest Standard Ambient Checkout.

All items require a pretest standard ambient checkout to provide baseline data. Conduct the pretest checkout as follows:

- Step 1 Examine the test item for physical defects, etc., and document the results.
- Step 2 Prepare the test item for test, in its operating configuration if required, as specified in the test plan.
- Step 3 Examine the test item/fixture/excitation system combination for compliance with test item and test plan requirements.
- Step 4 If applicable, conduct an operational checkout in accordance with the test plan and document the results for comparison with data taken during or after the test. If the test item fails to operate as required, resolve the problems and repeat the operational checkout.

4.5.2 Procedure.

The following steps provide the basis for collecting the necessary information concerning the platform and test item under MET testing.

- a. Procedure I – Time Domain Reference Criteria.
 - Step 1 Select the test conditions to be addressed and mount the test item on the excitation platform. Select the control locations and associated analysis techniques that will be used as potential test metrics (refer to Method 525.2, Annex A, and Annexes A, B, and C of this Method). Placement and polarity of all sensors (i.e. accelerometers) must match that of the reference signals (refer to Annex A). Clearly identify each axis of excitation and provide alignment procedures to ensure all measurements are made precisely along each excitation axis. Use all inherent information concerning the dynamic/geometric configuration of the test item, including specification of the center-of-gravity of the test item in three orthogonal axes, modal characteristics of the test fixturing, and all pertinent mass moments of inertia.
 - Step 2 If required; perform an operational check of the test item at defined environmental test conditions per the test plan. If the test item operates satisfactorily, proceed to Step 3. If not, resolve the problem(s) and repeat this step.
 - Step 3 Subject the test item (or dynamic simulant) to a system identification process that determines the initial exciter drive voltage signals by compensation. For the MDOF case, the initial signals sent to the exciters for compensation must be statistically independent, and form vectors that are linearly independent with respect to the DOFs to be tested. If a dynamic simulant is used, replace the dynamic simulant with the test item subsequent to the system identification and compensation phase.
 - Step 4 Subject the test item in its operational mode to the TWR compensated waveform. It is often desirable to make an initial run at less than full level to ensure proper dynamic response, and to validate proper functioning of the instrumentation.
 - Step 5 Record necessary data, including the control sensor time traces that can be processed to demonstrate that satisfactory replication of the matrix of reference time trace signals has been obtained.

MIL-STD-810H
METHOD 527.2

- Step 6 Continuously monitor vibration levels and, if applicable, test item performance throughout the exposure. If levels shift or a failure occurs, shut down the test in accordance with the test interruption procedure (paragraph 4.3.2). Determine the reason for the shift and proceed in accordance with the test interruption recovery procedure (paragraph 4.3.2).
- Step 7 Repeat Steps 4, 5, and 6 as specified in the test plan.
- Step 8 Remove the test item from the fixture and perform an operational check. Inspect the test item, mounting hardware, packaging, etc., for any signs of visual mechanical degradation that may have occurred during testing. See paragraph 5 for analysis of results.
- b. Procedure II – Frequency Domain Reference Criteria.
- Step 1 Select the test conditions to be addressed and mount the test item on the excitation platform. Select the control locations and associated analysis techniques that will be used as potential test metrics (refer to Annexes A, B, and D of this Method). Placement and polarity of all sensors (i.e. accelerometers) must match that of the reference signals (refer to Annex A). Clearly identify each axis of excitation and provide alignment procedures to ensure all measurements are made precisely along each excitation axis. Use all inherent information concerning the dynamic/geometric configuration of the test item, including specification of the center-of-gravity of the test item in three orthogonal axes, modal characteristics of the test fixturing, and all pertinent mass moments of inertia.
- Step 2 If required; perform an operational check on the test item at defined environmental test conditions per the test plan. If the test item operates satisfactorily, proceed to Step 3. If not, resolve the problem(s) and repeat this step.
- Step 3 Subject the test item (or dynamically accurate surrogate if available) to a system identification process. For the MDOF case, the initial signals sent to the exciters must be statistically independent and form vectors that are linearly independent with respect to the DOFs to be tested. If a dynamic simulant is used, replace the dynamic simulant with the test item subsequent to the system identification and compensation phase.
- Step 4 Subject the test item in its operational mode to the specification levels, monitoring both auto and cross-spectral density terms. It is almost always necessary to make an initial run at less than full level to ensure proper dynamic response, and to validate proper functioning of the instrumentation.
- Step 5 Record necessary data, including the control sensor auto and cross-spectral estimates that demonstrate satisfaction of the overall test objectives.
- Step 6 Continuously monitor vibration levels and, if applicable, test item performance throughout the exposure. If levels shift or a failure occurs, determine the reason for the shift, and follow the test interruption procedure (paragraph 4.3.2).
- Step 7 Repeat Steps 4, 5, and 6 as specified in the test plan.
- Step 8 Remove the test item from the fixture and perform an operational check. Inspect the test item, mounting hardware, packaging, etc., for any signs of visual mechanical degradation that may have occurred during testing. See paragraph 5 for analysis of results.

5. ANALYSIS OF RESULTS.

In addition to the guidance provided in Part One, paragraphs 5.14 and 5.17, and Part One, Annex A, Tasks 405 and 406, the following information is provided to assist in the evaluation of the test results. Analyze in detail any failure of a test item to meet the requirements of the system specification, and consider related information such as:

- a. Proper collection of information from the control accelerometer configuration, including representative durations of time trace information at all test levels based on expressions for estimate statistical error criteria. All time trace measurement information must be time-correlated to ensure proper estimation.
- b. Proper collection of information from the monitor accelerometer configuration (if any), including representative durations of time trace information at all test levels according to the same principles as used for control measurements.

MIL-STD-810H
METHOD 527.2

- c. Record the vendor MET software test tolerance information.
- d. If necessary, apply one or more of the techniques described in Annexes C and D for detailed comparison of the frequency domain information. In particular, use the collected time trace information to compute the agreed-upon test metrics.

5.1 Physics of Failure.

Analyses of vibration related failures must relate the failure mechanism to the dynamics of the failed item and to the dynamic environment. It is insufficient to determine that something broke due to high cycle fatigue or wear. It is necessary to relate the failure to the dynamic response of the materiel to the dynamic environment. The scope and detail of analysis should be coordinated with and approved by the appropriate test authority. It is recommended to include in the failure analysis a determination of resonant mode shapes, frequencies, damping values, and dynamic strain distributions, in addition to the usual material properties, crack initiation locations, etc.

5.2 Qualification Tests.

When a test is intended to show formal compliance with contract requirements, recommend the following definitions:

- a. Failure definition. “Materiel is deemed to have failed if it suffers permanent deformation or fracture; if any fixed part or assembly loosens; if any moving or movable part of an assembly becomes free or sluggish in operation; if any movable part or control shifts in setting, position, or adjustment, and if test item performance does not meet specification requirements while exposed to functional levels and following endurance tests.” Ensure this statement is accompanied by references to appropriate specifications, drawings, and inspection methods.
- b. Test completion. A vibration qualification test is complete when all elements of the test item have successfully passed a complete test.

5.3 Other Tests.

For tests other than qualification tests, prepare success and/or failure criteria and test completion criteria that reflect the purpose of the tests.

6. REFERENCE/RELATED DOCUMENTS.

6.1 Referenced Documents.

- a. NATO STANAG 4370, Environmental Testing, Allied Environmental Conditions and Test Publication (AECTP) 200, Mechanical Environmental Testing, Category 240.
- b. International Test Operations Procedure (ITOP) 01-1-050, “Development of Laboratory Vibration Test Schedules”, 6 June 1997, DTIC AD No. B227368.
- c. International Test Operations Procedure (ITOP) 01-2-601, “Laboratory Vibration Schedules”, 25 January 1999. DTIC AD No. B238288.
- d. Bendat, Julius S. and Allan G. Piersol, Random Data Analysis and Measurement Procedures, 3rd Edition, John Wiley & Sons, Inc., New York, 2000.
- e. Handbook for Dynamic Data Acquisition and Analysis, IEST-RD-DTE012.2; Institute of Environmental Sciences and Technology, Arlington Place One, 2340 S. Arlington Heights Road, Suite 100, Arlington Heights, IL 60005-4516; [Institute of Environmental Sciences and Technology Website](#).
- f. Fitz-Coy, Norman and Hale, Michael T., “On the Use of Linear Accelerometers in Six-DOF Laboratory Motion Replication: A Unified Time-Domain Analysis”, Proceedings of the 76th Shock and Vibration Symposium, Nov. 2005. Shock & Vibration Exchange (SAVE), 1104 Arvon Road, Arvon, VA 23004.
- g. Underwood, Marcos A. and Keller, Tony, “Applying Coordinate Transformations to Multi-DOF Shaker Control”, Sound and Vibration, January 2006, [Sound and Vibration Website](#).
- h. Shock and Vibration Handbook, 5th Edition, Edited by Cyril M. Harris and Allan G. Piersol, McGraw-Hill, New York NY, 2002.
- i. Smallwood, David O., “Multiple Shaker Random Vibration Control – An Update”, SAND 98-2044C.

MIL-STD-810H
METHOD 527.2

- j. Smallwood, David, Multiple-Input Multiple-Output (MIMO) Linear Systems Extreme Inputs/Outputs. Shock and Vibration 14 (2007) 107-131; IOS Press, Inc.
- k. Hale, Michael T., "Consideration of Global Error Metrics in the Conduct of MDOF Motion Replication", Proceedings of the 77th Shock and Vibration Symposium, Nov. 2006; Shock & Vibration Exchange (SAVE), 1104 Arvon Road, Arvon, VA 23004.
- l. Underwood, Marcos A. and Keller, Tony, "Using the Spectral Density Matrix to Determine Ordinary, Partial, and Multiple Coherence", Proceedings of the 77th Shock & Vibration Symposium, October, 2006; Monterey, California.
- m. Underwood, Marcos A., "Multi-Exciter Testing Applications: Theory and Practice", Proceedings – Institute of Environmental Sciences and Technology, April 2002.
- n. Plummer, A.R., "Control Techniques for Structural Testing: A Review", Proc. IMechE Vol. 221 Part I: J. Systems and Control Engineering, 2007.
- o. Welch, P.D., "The use of fast Fourier transform for the estimation of power spectra: A method based on time averaging over short, modified periodograms", *IEEE Transactions on Audio and Electroacoustics*, Vol. AU-15, No. 2, June 1967.
- p. Fitz-Coy, N, Hale, M. and Nagabhushan, V., "Benefits and Challenges of Over-Actuated Excitation Systems", Shock and Vibration Journal, Volume 17, Number 3 / 2010.
- q. Hale, Michael T., "Spectral Density Matrix Transformations", Journal of the IEST, V. 60, No. 1, pp 17-26, 2017.

6.2 Related Documents.

Egbert, Herbert W. "The History and Rationale of MIL-STD-810 (Edition 2)", January 2010; Institute of Environmental Sciences and Technology, Arlington Place One, 2340 S. Arlington Heights Road, Suite 100, Arlington Heights, IL 60005-4516.

(Copies of Department of Defense Specifications, Standards, and Handbooks, and International Standardization Agreements are available online at <https://assist.dla.mil>.)

Requests for other defense-related technical publications may be directed to the Defense Technical Information Center (DTIC), ATTN: DTIC-BR, Suite 0944, 8725 John J. Kingman Road, Fort Belvoir VA 22060-6218, 1-800-225-3842 (Assistance--selection 3, option 2), <http://www.dtic.mil/dtic/>; and the National Technical Information Service (NTIS), Springfield VA 22161, 1-800-553-NTIS (6847), <http://www.ntis.gov/>.

MIL-STD-810H
METHOD 527.2

(This page is intentionally blank.)

MIL-STD-810H
METHOD 527.2 ANNEX A**METHOD 527.2, ANNEX A****ENGINEERING INFORMATION FOR MET TRANSDUCER PLACEMENT****1. GENERAL PHILOSOPHY FOR A MET.**

The general philosophy for a Multi-Exciter Test (MET) is essentially the same as that of the Single Exciter case; however, there are additional considerations that need to be addressed in the conduct of a MET. It is addressing the additional considerations associated with MESA and MEMA, and assessing the adequacy of a laboratory MET, i.e., comparing the reference time histories or spectral content with the results obtained in laboratory based tests, that are the concerns of this Annex. As of the inclusion of this new test method into MIL-STD-810G, the primary vibration control system vendors offer MET options for time waveform replication (TWR), sine, shock, and random. Options for combined environments such as narrowband-random-on-random and sine-on-random are generally implemented via TWR based techniques.

In the simplest terms for MESA and MEMA tests, multiple exciters are employed to excite one or more mechanical-degrees-of-freedom. For traditional SESA testing, the test reference is provided as either a single reference time trace as discussed in Method 525.2, or in terms of simple magnitude versus frequency plots such as an auto spectral density as discussed in Method 514.8. For a MET, multiple channels are required in the control process. For a MET defined in the time domain, multiple time traces will be required, and for a MET defined in the frequency domain, cross spectral densities are required in addition to auto-spectral parameters in defining the test reference. For either case, the system identification (transfer function) estimation process is now a matrix operation as opposed to a simple division as in the SESA case.

The additional complexities associated with MESA and MEMA testing require an increased level of technical skill from the test engineers in planning such tests, and from the test operators that will ultimately perform the tests. Test objectives must be clearly understood to ensure that, in addressing the inevitable test-specific obstacles associated with any MDOF test, the test objectives are still properly addressed.

2. REFERENCE POINT CONSIDERATIONS FOR MDOF TESTING.**2.1 Reference Data Considerations.**

The first step in performing a MET in the laboratory begins with acquiring sufficient reference data. In addition to the standard concerns related to the dynamic range and frequency response characteristics of the transducers and recording equipment used in the field data acquisition phase, the quantity and spatial locations of the transducers become critical test parameters. Understanding the underlying dynamics of MDOF systems, and the physical constraints such systems place on the spatial locations of reference transducers in order to perform true MDOF laboratory motion replication, is not trivial. Similarly, it is essential that the test operators are able to understand the dynamics of an arbitrary data set that may be provided by an outside source for use as reference data in a laboratory test.

2.2 Reference Point Kinematics.

A unified discussion on the use of linear accelerometers for motion reconstruction is addressed in paragraph 6.1, reference f. Specifically, paragraph 6.1, reference f, investigated the number of uni-axial transducers required, and the placement of these transducers in the field data acquisition phase for 6-DOF motion reconstruction. The principal analysis is performed in the time domain using kinematical relationships from classical mechanics.

MIL-STD-810H
METHOD 527.2 ANNEX A

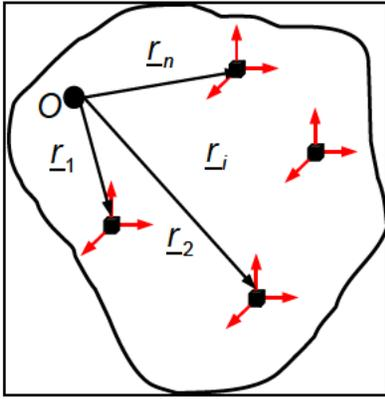


Figure 527.2A-1: Body with n accelerometers. Placements.

In addressing the laboratory inputs required for 6-DOF replication, paragraph 6.1, references f and p also consider a body equipped with n tri-axial linear accelerometers located as shown in Figure 527.2A-1. It is well known from classical mechanics that the acceleration measured by the i^{th} transducer is given kinematically by

$$\underline{a}_i = \underline{a}_o + \underline{\alpha} \times \underline{r}_i + \underline{\omega} \times (\underline{\omega} \times \underline{r}_i) + \underline{\varepsilon}_i, i=1,2,\dots,n, \quad (1)$$

where \underline{a}_o represents the acceleration of a reference point in the body, $\underline{\alpha}$ and $\underline{\omega}$ represent, respectively, the rigid body angular acceleration and angular velocity, \underline{r}_i the location of the i^{th} transducer relative to the reference point, and $\underline{\varepsilon}_i = \underline{\ddot{r}}_i + 2\underline{\omega} \times \underline{\dot{r}}_i$ represents the contributions due to non-rigid body effects (i.e., flexibility). Ignoring the flexibility effects (i.e., $\underline{\varepsilon}_i = \underline{0}$), Equation 1 represents n vector equations in three vector unknowns (i.e., \underline{a}_o , $\underline{\omega}$, and $\underline{\alpha}$). In general, \underline{a}_o is unknown unless a transducer was selected *a priori* for that location. For notational convenience, matrix equivalent operations were used to rewrite Equation 1 as shown in Equation 2 where the flexibility effects have also been neglected.

$$\underline{a}_i = \underline{a}_o + \underline{\alpha}^x \underline{r}_i + \underline{\omega}^x \underline{\omega}^x \underline{r}_i = \underline{a}_o + \underline{\underline{\Omega}} \underline{r}_i, i=1,2,\dots,n \quad (2)$$

In Equation (2), $\underline{\alpha}^x$ and $\underline{\omega}^x$ are skew symmetric matrices representing the vector cross products, and $\underline{\underline{\Omega}} \triangleq \underline{\alpha}^x + \underline{\omega}^x \underline{\omega}^x$ represent the contributions of angular motion to the measured linear acceleration (i.e., the contributions of “tangential” and “centripetal” accelerations). Assuming that $\underline{\alpha} = \alpha_x \hat{i} + \alpha_y \hat{j} + \alpha_z \hat{k}$ and $\underline{\omega} = \omega_x \hat{i} + \omega_y \hat{j} + \omega_z \hat{k}$ are the angular acceleration and angular velocity coordinatized in the body fixed frame, then

$$\underline{\alpha}^x = \begin{bmatrix} 0 & -\alpha_z & \alpha_y \\ \alpha_z & 0 & -\alpha_x \\ -\alpha_y & \alpha_x & 0 \end{bmatrix}, \quad \underline{\omega}^x = \begin{bmatrix} 0 & -\omega_z & \omega_y \\ \omega_z & 0 & -\omega_x \\ -\omega_y & \omega_x & 0 \end{bmatrix}, \quad \text{and} \quad \underline{\underline{\Omega}} = \begin{bmatrix} -(\omega_y^2 + \omega_z^2) & \omega_x \omega_y - \alpha_z & \omega_x \omega_z + \alpha_y \\ \omega_x \omega_y + \alpha_z & -(\omega_x^2 + \omega_z^2) & \omega_y \omega_z - \alpha_x \\ \omega_x \omega_z - \alpha_y & \omega_y \omega_z + \alpha_x & -(\omega_x^2 + \omega_y^2) \end{bmatrix}$$

True motion replication in the laboratory using the measured accelerations (field data) to construct the drive point accelerations will require knowledge of \underline{a}_o (three unknowns) and $\underline{\underline{\Omega}}$ (nine unknowns), for a total of 12 unknowns. A closer examination of $\underline{\underline{\Omega}}$, however, reveals the matrix is comprised of only six unique unknowns (i.e., the components of $\underline{\alpha}$ and $\underline{\omega}$). Thus, if \underline{a}_o , $\underline{\alpha}$, and $\underline{\omega}$ can be determined from measured field data, theoretically, the motion in the field can be exactly (within the limits of the measurement devices) replicated in the laboratory. From paragraph 6.1, reference f, it was shown that in the most general case, nine parameters (\underline{a}_o , $\underline{\omega}$, $\underline{\alpha}$) are required to reconstruct the motion and, thus, the minimum number of required transducer channels is nine. The analysis was also used to show that if specific restrictions are imposed on the motion (e.g., $\underline{a}_o = \underline{0}$), six properly placed accelerometers would be sufficient. Additionally, if consideration was given to the rigid body kinematic relationship between the angular velocity $\underline{\omega}$ and the angular acceleration $\underline{\alpha}$ (i.e., $\underline{\alpha} = \frac{d\underline{\omega}}{dt}$), then implementation in the frequency domain also reduces the number of required parameters from nine to six.

The two stated restrictions (i.e., $\underline{a}_o = \underline{0}$ or frequency domain implementation) that result in six transducers being sufficient, are consistent with the conditions found in the vibration testing environment. An assumption of $\underline{a}_o = \underline{0}$ does not necessarily provide sufficient information for exact motion reconstruction. In fact, it was shown that in the most general case, only $\underline{\alpha}$ could be uniquely determined and, thus, additionally, the kinematic relationship between $\underline{\alpha}$ and $\underline{\omega}$ has to be exploited. Hence, the most influential of the two restrictions is the simplified relationship between angular velocity and angular acceleration in the frequency domain (i.e., $\underline{\alpha}(s) = s\underline{\omega}(s)$). Note that this condition is

MIL-STD-810H
METHOD 527.2 ANNEX A

only valid for rigid bodies. Once flexibility is considered, this simplification no longer exists and, thus, the use of six transducers becomes questionable.

From an implementation perspective, while it has been shown that six properly located linear accelerometers are sufficient to use as a basis for 6-DOF motion replication, it is also obvious that near ideal conditions are required. Specifically, and as is generally the case for laboratory vibration tests, $\underline{a}_0 \cong \underline{0}$ in Equation 1 is a necessary requirement to ensure accurate replication of acceleration and velocity at unmonitored points on the test item. A more realistic concern is that, in practice, one is not necessarily working with a rigid body, and the fact that there will inevitably be a mechanical impedance mismatch between the field and laboratory conditions. Under such conditions, predictably there will be issues with the condition number of the system transfer function matrix \mathbf{H}_{xy} .

To address such issues, it is strongly recommended that an over-determined feedback scheme (number of control channels > number of mechanical DOF) consisting of properly placed linear accelerometers be employed. One such proven control configuration is selection of three non-collinear tri-axial clusters of linear accelerometers. This control configuration is very versatile in that any plane may be used, with the only critical factor being that the relative positions of the transducers remain non-collinear.

MIL-STD-810H
METHOD 527.2 ANNEX A

(This page is intentionally blank.)

MIL-STD-810H
METHOD 527.2 ANNEX B**METHOD 527.2, ANNEX B****SYSTEM IDENTIFICATION FOR LINEAR TIME-INVARIANT MDOF SYSTEMS****1. TRANSFER-FUNCTION ESTIMATIONS.**

Exploiting the over-determined feedback technique as discussed in Annex A is also advantageous in providing a weighting technique, analogous to the common practice in traditional SDOF testing in which various multiple-channel averaging schemes are employed to address payload dynamics issues. In the conduct of an MDOF vibration test, if an over-determined feedback scheme consisting of properly placed linear accelerometers is employed, \mathbf{H}_{xy} is approximated in a Least-Squares sense, thereby providing a sound method of implementing a multi-channel control scheme. However, as is the case for the general 1-DOF case, one should always optimize the fixture design because no control scheme will force motion of a structure in an unnatural manner. The accuracy of the Least Squares approximation of \mathbf{H}_{xy} will be directly related to the degree of modal similarity between the field deployment platform and the laboratory test platform.

Based on the previous discussion of kinematic considerations for transducer placement, it is clear that great care must be taken to establish a central point to which all measurement locations could be referenced. Carefully measure and record the specific location and polarity of each transducer. In addition, this process requires forethought as to how the test item will be fixtured in the laboratory to ensure the “exact” measurement locations can be used.

2. SIGNAL TRANSFORMATION.

For a situation in which the reference signals for a 6-DOF test are provided in the traditional translational (X, Y, and Z) and rotational (Pitch (rotation about Y), Roll (rotation about X), and Yaw (rotation about Z)) engineering units (EU), one may wish to transform between appropriately placed linear transducers and traditional 6-DOF EUs. Since there are many combinations of exciters that may be employed for a given MDOF test, the transformation matrix between linear accelerometers and traditional 6-DOF EUs, the transformation matrix will be test specific. In addition, one may wish to apply non-uniform weighting across the exciters for a given DOF, or even include non-rotational or non-translational degrees-of-freedom such as tensional response into consideration in developing the control law for a given test. Kinematics based output-signal transformations are also very useful in addressing over-actuated systems to ensure properly compensated signals are sent to exciters with common mechanical degrees-of-freedom. A detailed discussion of signal transformation is given in paragraph 6.1, references g and n.

3. CONTROL IMPLEMENTATION.

It is not the intent of this document to provide the specifics of the control algorithms used in the conduct of MESA and MEMA vibration testing. In fact, the various MET control system vendors do not always approach control in the same manner. There are, however, a few basic concepts that are keys to the MESA and MEMA control problem that will be addressed in the following sections.

The theory relative to linear accelerometer placement discussed in Annex A was developed from a time domain perspective. While the time domain approach is very useful in developing an understanding of the basic rigid body kinematics leading to establishing requirements for mapping of acceleration to an arbitrary point (i.e., a drive point), it is not practical to implement as a real time control scheme. In practice, the drive files are generated based on frequency-domain transfer function approximations.

Control system vendors have developed various control algorithms for conduct of a MDOF MET. Although vendors may consider the details of many of their vendor specific techniques to be proprietary, the following general discussion regarding type H_1 transfer function estimations for a MDOF case is still relevant, and serves as a working introduction to the basic control scheme. Basic definitions are reviewed to illustrate the importance of cross-spectrum components in the conduct of a MDOF MET. This discussion is summarized in this Annex and discussed in detail by Bendat and Piersol in paragraph 6.1, reference d.

3.1 SISO Auto and Cross-Spectral Definitions Review.

Prior to matrix-based discussions of transfer function estimates for a MET, consider the following basic scalar definitions as presented by Bendat and Piersol in paragraph 6.1, reference d. The discussions assume two stationary (ergodic) Gaussian random processes $\{x(t)\}$ and $\{y(t)\}$. The finite Fourier Transforms of $\{x(t)\}$ and $\{y(t)\}$ are defined as:

MIL-STD-810H
METHOD 527.2 ANNEX B

$$X(f) = X(f, T) = \int_0^T x(t) e^{-j2\pi ft} dt$$

$$Y(f) = Y(f, T) = \int_0^T y(t) e^{-j2\pi ft} dt$$

The auto and cross-spectral densities of $x(t)$ and $y(t)$ for an “unlimited time” length T are defined respectively as:

$$G_{xx}(f) = 2 \lim_{T \rightarrow \infty} \frac{1}{T} E \left[|X(f, T)|^2 \right]$$

$$G_{yy}(f) = 2 \lim_{T \rightarrow \infty} \frac{1}{T} E \left[|Y(f, T)|^2 \right]$$

$$G_{xy}(f) = 2 \lim_{T \rightarrow \infty} \frac{1}{T} E \left[X^*(f) Y(f) \right]$$

Estimates of $G_{xx}(f)$, $G_{yy}(f)$ and $G_{xy}(f)$ as computed over a “finite time” interval are defined as:

$$\tilde{G}_{xx}(f) = S_{xx}(f) = \frac{2}{T} \left[|X(f, T)|^2 \right]$$

$$\tilde{G}_{yy}(f) = S_{yy}(f) = \frac{2}{T} \left[|Y(f, T)|^2 \right]$$

$$\tilde{G}_{xy}(f) = S_{xy}(f) = \frac{2}{T} \left[X^*(f) Y(f) \right]$$

and will have a discrete spectral resolution of $B_e \approx \Delta f = \frac{1}{T}$. Employment of $S_{xx}(f)$, $S_{yy}(f)$ and $S_{xy}(f)$ will generally be unacceptable due to the large random error associated with the “raw” estimate. In practice, the random error is reduced, (refer to paragraph 6.1, reference d, for a detailed error discussion), by computing an ensemble of n_d different averages of length T to obtain a “smooth” estimate defined as:

$$\hat{G}_{xx}(f) = \frac{2}{n_d T} \sum_{i=1}^{n_d} \left[|X(f, T)|^2 \right]$$

$$\hat{G}_{yy}(f) = \frac{2}{n_d T} \sum_{i=1}^{n_d} \left[|Y(f, T)|^2 \right]$$

$$\hat{G}_{xy}(f) = \frac{2}{n_d T} \sum_{i=1}^{n_d} \left[X^*(f) Y(f) \right]$$

3.2 SISO Transfer Function and Coherence Function Definitions Review.

Another very useful tool in the analysis of SISO linear systems are the transfer function and associated coherence estimates. Again, both concepts are explained in detail within paragraph 6.1, reference d. Using the previously defined auto and cross-spectrum definitions, the optimum frequency response function (transfer function) is defined as:

$$\hat{H}_{xy}(f) = \frac{\hat{G}_{xy}(f)}{\hat{G}_{xx}(f)}$$

and the associated coherence function is defined as:

$$\hat{\gamma}_{xy}^2(f) = \frac{|\hat{G}_{xy}(f)|^2}{\hat{G}_{xx}(f) \hat{G}_{yy}(f)}$$

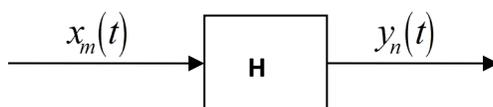
The transfer function provides a frequency domain view of the gain and phase relationship between the input and output signals, while the coherence function indicates the amount of causality in the transfer function. The coherence function range is $0 \leq \hat{\gamma}_{xy}^2(f) \leq 1$, with 0 representing no causality and 1 representing perfect causality. Observe that

MIL-STD-810H
METHOD 527.2 ANNEX B

for the SISO case, computation of both $\hat{H}(f)$ and $\gamma_{xy}^2(f)$ are simple division operations to be performed at each of the discrete spectral lines. The following paragraph takes a general MIMO view of the SISO scenario just discussed. In the following discussions, all estimates will be considered to be “smoothed” through the use of an appropriate number of measurements and the $\hat{}$ symbol will be eliminated.

3.3 MIMO Auto-Spectra, Cross-Spectra, and Initial Function Estimates.

Consider the MIMO system described below consisting of m inputs and n outputs. Note that, for the general case, $m \neq n$. (A Linear Time-Invariant (LTI) system is assumed).



3.3.1 Frequency Domain Transfer Function Relationship.

Develop a Frequency Domain transfer function relationship between the input and output. The following discussion is one of multiple approaches. Welch’s method, paragraph 6.1 reference o, is generally used to compute a smoothed estimate of the spectral terms in the following discussion.

- a. Define $\mathbf{X}(\mathbf{f})$ as column vector of the m input signals and $\mathbf{Y}(\mathbf{f})$ as a column vector of the n output signals.

$$\mathbf{X} = \begin{bmatrix} X_1 \\ X_2 \\ \cdot \\ \cdot \\ X_m \end{bmatrix}, \quad \mathbf{Y} = \begin{bmatrix} Y_1 \\ Y_2 \\ \cdot \\ \cdot \\ Y_n \end{bmatrix}$$

- b. Define the Transfer Function Matrix between $\mathbf{X}(\mathbf{f})$ and $\mathbf{Y}(\mathbf{f})$ as $\mathbf{H}_{xy}(\mathbf{f})$ such that the *input* precedes the *output*.

$$\mathbf{H}_{xy} = \begin{bmatrix} H_{11} & H_{12} & \cdot & \cdot & H_{1n} \\ H_{21} & H_{22} & \cdot & \cdot & H_{2n} \\ \cdot & \cdot & \cdot & \cdot & \cdot \\ \cdot & \cdot & \cdot & \cdot & \cdot \\ H_{m1} & H_{m2} & & & H_{mn} \end{bmatrix}$$

- c. Define the Instantaneous Power Spectra as:

$$\mathbf{S}_{xx} = \mathbf{X}^* \mathbf{X}' \quad \text{Instantaneous Input Auto-Spectrum (Dim: } m \times m)$$

$$\mathbf{S}_{yy} = \mathbf{Y}^* \mathbf{Y}' \quad \text{Instantaneous Output Auto-Spectrum (Dim: } n \times n)$$

$$\mathbf{S}_{xy} = \mathbf{X}^* \mathbf{Y}' \quad \text{Instantaneous Cross-Spectrum (Dim: } m \times n)$$

- d. Define the Cumulative Power Spectra over k averages as:

$$\mathbf{G}_{xx} = \frac{1}{k} \sum_{i=1}^k \mathbf{S}_{xx_i} \quad \text{Cumulative Input Auto-Spectrum (Dim: } m \times m)$$

$$\mathbf{G}_{yy} = \frac{1}{k} \sum_{i=1}^k \mathbf{S}_{yy_i} \quad \text{Cumulative Output Auto-Spectrum (Dim: } n \times n)$$

$$\mathbf{G}_{xy} = \frac{1}{k} \sum_{i=1}^k \mathbf{S}_{xy_i} \quad \text{Cumulative Cross-Spectrum (Dim: } m \times n)$$

MIL-STD-810H
METHOD 527.2 ANNEX B

3.3.2 Key Transfer Function Derivations.

Given the definitions a. and b. above, it follows that:

$$\mathbf{Y} = \mathbf{H}'_{xy} \mathbf{X}$$

$$\begin{bmatrix} Y_1 \\ Y_2 \\ \cdot \\ \cdot \\ Y_n \end{bmatrix} = \begin{bmatrix} H_{11} & H_{21} & \cdot & \cdot & H_{m1} \\ H_{12} & H_{22} & \cdot & \cdot & H_{m2} \\ \cdot & \cdot & \cdot & \cdot & \cdot \\ \cdot & \cdot & \cdot & \cdot & \cdot \\ H_{1n} & H_{2n} & \cdot & \cdot & H_{mn} \end{bmatrix} \begin{bmatrix} X_1 \\ X_2 \\ \cdot \\ \cdot \\ X_m \end{bmatrix}$$

Re-write the input/output relationship in terms of the cumulative auto and cross spectra as defined above in paragraph 3.3.1d.

$$\mathbf{Y}' = (\mathbf{H}'_{xy} \mathbf{X})' = \mathbf{X}' \mathbf{H}_{xy}$$

$$\mathbf{X}^* \mathbf{Y}' = \mathbf{X}^* \mathbf{X}' \mathbf{H}_{xy}$$

$$\mathbf{G}_{xy} = \frac{1}{k} \sum_{i=1}^k \mathbf{X}_i^* \mathbf{Y}'_i = \frac{1}{k} \sum_{i=1}^k \mathbf{X}_i^* \mathbf{X}'_i \mathbf{H}_{xy} = \left[\frac{1}{k} \sum_{i=1}^k \mathbf{X}_i^* \mathbf{X}'_i \right] \mathbf{H}_{xy} = \mathbf{G}_{xx} \mathbf{H}_{xy}$$

$$\mathbf{G}_{xy} = \mathbf{G}_{xx} \mathbf{H}_{xy}$$

$$\mathbf{G}_{xx}^{-1} \mathbf{G}_{xy} = \mathbf{G}_{xx}^{-1} \mathbf{G}_{xx} \mathbf{H}_{xy}$$

$$\mathbf{G}_{xx}^{-1} \mathbf{G}_{xy} = \mathbf{H}_{xy}$$

$\begin{matrix} \text{mxm} & \text{mxn} & \text{mxn} \end{matrix}$

In performing laboratory MET, the initial estimation of \mathbf{H}_{xy} will be computed based on a set of *uncorrelated random input signals*. The desired signal, \mathbf{Y} , will have been either measured directly, or possibly computed via a 6-DOF model based prediction, leaving \mathbf{X} (that will represent the input to the vibration exciter) as the unknown.

Recall that $\mathbf{Y} = \mathbf{H}'_{xy} \mathbf{X}$, therefore, $(\mathbf{H}'_{xy})^{-1} \mathbf{Y} = (\mathbf{H}'_{xy})^{-1} \mathbf{H}'_{xy} \mathbf{X}$ yielding $(\mathbf{H}'_{xy})^{-1} \mathbf{Y} = \mathbf{X}$.

Note that for the general case in which $m \neq n$, the computation of $(\mathbf{H}'_{xy})^{-1}$ will require a pseudo-inverse (Moore-Penrose) approximation. This computation involves a singular value decomposition (SVD) of \mathbf{H}'_{xy} . Viewing the singular values provides two useful pieces of information. First, it provides information on a spectral line basis as to the rank of \mathbf{H}'_{xy} , and second, it provides an indication as to the dynamic range of \mathbf{H}'_{xy} , thereby providing insight into the potential for noise in computation of the drive files. Estimations of \mathbf{H}'_{xy} via SVD techniques are more computationally intense than classical methods such as the Cholesky decomposition; however, the SVD technique is more robust and capable of addressing rectangular and singular matrices. SVD techniques also provide straight forward methods of addressing dynamic range and noise by investigating the ratio of the largest to smallest singular values.

From a Procedure II control algorithm perspective, one may be interested in computation of \mathbf{G}_{xx} directly from \mathbf{H}_{xy} .

Recall from above that $\mathbf{Y} = \mathbf{H}'_{xy} \mathbf{X}$, from which the following is derived:

MIL-STD-810H
METHOD 527.2 ANNEX B

$$\begin{aligned} \mathbf{Y} &= \mathbf{H}'_{xy} \mathbf{X} \\ \mathbf{Y}' &= (\mathbf{H}'_{xy} \mathbf{X})' = \mathbf{X}' \mathbf{H}_{xy} \\ \mathbf{Y}^* &= (\mathbf{H}'_{xy} \mathbf{X})^* = \mathbf{H}^*_{xy} \mathbf{X}^* \\ \mathbf{Y}^* \mathbf{Y}' &= (\mathbf{H}^*_{xy} \mathbf{X}^*) (\mathbf{X}' \mathbf{H}_{xy}) \end{aligned}$$

This yields:

$$\begin{aligned} \mathbf{G}_{yy} &= \frac{1}{k} \sum_{i=1}^k \mathbf{Y}_i^* \mathbf{Y}'_i = \frac{1}{k} \sum_{i=1}^k \mathbf{H}^*_{xy} \mathbf{X}'_i [\mathbf{X}'_i \mathbf{H}_{xy}] = \mathbf{H}^*_{xy} \left[\frac{1}{k} \sum_{i=1}^k \mathbf{X}'_i \mathbf{X}_i \right] \mathbf{H}_{xy} = \mathbf{H}^*_{xy} \mathbf{G}_{xx} \mathbf{H}_{xy} \\ \mathbf{G}_{yy} &= \mathbf{H}^*_{xy} \mathbf{G}_{xx} \mathbf{H}_{xy} \end{aligned}$$

Which leads directly to:

$$\mathbf{G}_{xx} = (\mathbf{H}^*_{xy})^{-1} \mathbf{G}_{yy} (\mathbf{H}_{xy})^{-1}$$

Paragraph 6.1, reference d, goes into considerably more detail, to include error analysis, regarding the discussion above. In addition, the various control system vendors continue to improve on the basic concepts using unique (and often proprietary) techniques to improve convergence to the reference array based on error in both time and frequency domains. The discussion above serves as an illustration through use of well defined and established analyses of the increased level of complexity associated with MDOF vibration testing. Of particular interest are that the fundamental principles are based on the assumption that the excitation system is LTI, and that the reference measurements were acquired from a kinematically consistent body. Clearly, neither assumption holds for the majority of laboratory vibration tests, even in the SESA case. The issue at hand is establishing metrics of acceptability for a MET.

3.3.3 Key Transfer Function Derivations Alternative.

An alternative to the derivations in paragraphs 3.3.1 and 3.3.2, which is commonly employed in the MIMO vibration control arena, is based on making the following minor changes in definitions within paragraph 3.3.1:

- Define $\mathbf{X}(\mathbf{f})$ as column vector of the m input signals and $\mathbf{Y}(\mathbf{f})$ as a column vector of the n output signals as defined in paragraph 3.3.1.

$$\mathbf{X} = \begin{bmatrix} X_1 \\ X_2 \\ \cdot \\ \cdot \\ X_m \end{bmatrix}, \quad \mathbf{Y} = \begin{bmatrix} Y_1 \\ Y_2 \\ \cdot \\ \cdot \\ Y_n \end{bmatrix}$$

- Define the Transfer Function Matrix between $\mathbf{X}(\mathbf{f})$ and $\mathbf{Y}(\mathbf{f})$ as $\mathbf{H}_{yx}(\mathbf{f})$ such that the *output* precedes the *input*. Recalling \mathbf{H}_{xy} as defined in paragraph 3.3.1, observe that $\mathbf{H}_{yx} = \mathbf{H}'_{xy}$ and that $\mathbf{H}^{-1}_{xy} \neq \mathbf{H}_{yx}$.

$$\mathbf{H}_{yx} = \begin{bmatrix} H_{11} & H_{21} & \cdot & \cdot & H_{m1} \\ H_{12} & H_{22} & \cdot & \cdot & H_{m2} \\ \cdot & \cdot & \cdot & \cdot & \cdot \\ \cdot & \cdot & \cdot & \cdot & \cdot \\ H_{1n} & H_{2n} & \cdot & \cdot & H_{mn} \end{bmatrix}$$

$$\mathbf{Y} = \underset{\substack{\text{nx1} \\ \text{nxm}}}{\mathbf{H}_{yx}} \underset{\text{mx1}}{\mathbf{X}}$$

MIL-STD-810H
METHOD 527.2 ANNEX B

c. Define the Instantaneous Power Spectra as:

$$\begin{aligned}\hat{\Phi}_{xx} &= \mathbf{X}\mathbf{X}^{*} && \text{Instantaneous Input Auto-Spectrum (Dim: } m \times m) \\ \hat{\Phi}_{yy} &= \mathbf{Y}\mathbf{Y}^{*} && \text{Instantaneous Output Auto-Spectrum (Dim: } n \times n) \\ \hat{\Phi}_{yx} &= \mathbf{Y}\mathbf{X}^{*} && \text{Instantaneous Cross-Spectrum (Dim: } n \times m)\end{aligned}$$

Observe in comparison to the definitions provided in paragraph 3.3.1 that:

$$\hat{\Phi}_{xx} = \mathbf{S}'_{xx}, \quad \hat{\Phi}_{yy} = \mathbf{S}'_{yy}, \quad \text{and} \quad \hat{\Phi}_{yx} = \mathbf{S}'_{xy}$$

d. Define the Cumulative Power Spectra over k averages as:

$$\begin{aligned}\Phi_{xx} &= \frac{1}{k} \sum_{i=1}^k \hat{\Phi}_{xx i} && \text{Cumulative Input Auto-Spectrum (Dim: } m \times m) \\ \Phi_{yy} &= \frac{1}{k} \sum_{i=1}^k \hat{\Phi}_{yy i} && \text{Cumulative Output Auto-Spectrum (Dim: } n \times n) \\ \Phi_{yx} &= \frac{1}{k} \sum_{i=1}^k \hat{\Phi}_{yx i} && \text{Cumulative Cross-Spectrum (Dim: } n \times m)\end{aligned}$$

Observe in comparison to the definitions provided in paragraph 3.3.1 that:

$$\Phi_{xx} = \mathbf{G}'_{xx}, \quad \Phi_{yy} = \mathbf{G}'_{yy}, \quad \text{and} \quad \Phi_{yx} = \mathbf{G}'_{xy}$$

Applying the input/output relationship of an LTI system, and by making the following substitutions based on the definitions for the cumulative auto and cross spectra as defined above in paragraphs 3.3.3c and 3.3.3d yields the following:

$$\begin{aligned}\Phi_{yy} &= \frac{1}{k} \sum_{i=1}^k \mathbf{Y}_i \mathbf{Y}_i^{*} = \frac{1}{k} \sum_{i=1}^k \mathbf{H}_{yx} \mathbf{X}_i [\mathbf{H}_{yx} \mathbf{X}_i]^{*} = \frac{1}{k} \sum_{i=1}^k \mathbf{H}_{yx} \mathbf{X}_i \mathbf{X}_i^{*} \mathbf{H}_{yx}^{*} = \mathbf{H}_{yx} \Phi_{xx} \mathbf{H}_{yx}^{*} \quad \text{and,} \\ \Phi_{xx} &= \mathbf{H}_{yx}^{-1} \Phi_{yy} [\mathbf{H}_{yx}^{*}]^{-1} \quad \text{Or, by defining } \mathbf{Z} = \mathbf{H}_{yx}^{-1} \text{ simplifies to } \Phi_{xx} = \mathbf{Z} \Phi_{yy} \mathbf{Z}^{*}\end{aligned}$$

$$\Phi_{yx} = \frac{1}{k} \sum_{i=1}^k \mathbf{Y}_i \mathbf{X}_i^{*} = \frac{1}{k} \sum_{i=1}^k \mathbf{H}_{yx} \mathbf{X}_i \mathbf{X}_i^{*} = \mathbf{H}_{yx} \frac{1}{k} \sum_{i=1}^k \mathbf{X}_i \mathbf{X}_i^{*} = \mathbf{H}_{yx} \Phi_{xx} \quad \text{which leads to:}$$

$$\Phi_{yx} \Phi_{xx}^{-1} = \mathbf{H}_{yx}$$

Observe that two approaches discussed within paragraph 3.3 are very similar in structure. Selection of technique is generally one of preference or possibly computational advantage.

3.4 MIMO Coherence Functions.

The concept of coherence will need to be expanded to address the MIMO case. Refer to the paragraph 6.1, references d and l, for a detailed discussion on this subject. Following, are three basic coherence definitions that apply to the MIMO case for a linear system.

3.4.1 Ordinary Coherence.

The ordinary coherence function is defined as the correlation coefficient describing the linear relationship between any two single spectra. In the multiple input case, care must be taken in interpretation of ordinary coherence. It is possible that the coherence between the output and a given input may be much less than unity, even if the relationship is strictly linear due to the influence of other input signals. For a linear MIMO system, the ordinary coherence is defined as:

$$\gamma_{mn}^2(f) = \frac{|G_{xy_{mn}}|^2}{G_{xx_{mm}} G_{yy_{nn}}} \quad \text{where,}$$

MIL-STD-810H
METHOD 527.2 ANNEX B

$G_{x_{mm}}(f)$ = auto-spectrum of the input m

$G_{y_{nn}}(f)$ = auto-spectrum of the output n

$G_{xy_{mn}}(f)$ = cross-spectrum between input m and output n

3.4.2 Partial Coherence.

The partial coherence function is defined as the ordinary coherence between one conditioned output and another conditioned output, between one conditioned input and another conditioned input, or between one conditioned input and a conditioned output. The individual input and output signals are “conditioned” by removing the contributions from other inputs. There is a partial coherence function that exists for every input-input, output-output, and input-output combination for all permutations of conditioning.

3.4.3 Multiple Coherence.

The multiple coherence function is defined as the correlation coefficient describing the linear relationship between a given output and all known inputs. A multiple coherence function exists for each output signal. The multiple coherence function provides an excellent method of evaluating the degree and relative importance of unknown contributions such as noise and nonlinearities to each output signal.

As is the case for ordinary coherence, a low multiple coherence value represents a low causality between the output signal of interest and the input signals. This information is critical in the closed loop control process in that it will influence the transfer function estimate. In fact, MDOF control systems use the multiple coherence function as a key test parameter. Specifically, the control algorithm will compute the multiple coherence for each output channel at each spectral line. Prior to updating the transfer function during a test, the multiple coherence function will be evaluated to ensure a specific threshold is achieved, (i.e. $\gamma_{mn}^2(f) \geq 0.7$). If the user-defined threshold has not been achieved, the transfer function for that spectral line will not be updated. Partial and multiple coherence are discussed in detail in paragraph 6.1, reference d. Underwood also provides an interesting perspective of both partial and multiple coherence in paragraph 6.1, reference l.

3.5 Drive Signal Compensation.

The previous discussions of auto and cross-spectral densities and how they are used in the computation of the system transfer function and associated coherence functions are all applied in the initial system identification phase in a MET. Subsequent to the initial system identification, the output (drive) signals are updated similar to the traditional SESA case. Although the details of each control system vendor’s algorithms will vary, there are two basic drive signal update methodologies.

The first drive signal update technique is based simply on continuous updates of the system transfer function, and is performed throughout the duration of the test to address minor system changes (paragraph 6.1, reference m). Note that for any frequencies for which the drive signals are fully correlated, corrections to the system transfer function will not be possible.

The second drive signal update technique is based on the error spectrum that is computed between the feedback spectrum and the specified reference spectrum. Typically, some fraction of the error is applied to a correction of the coupling matrix corrected during each loop. The coupling matrix is the spectral density matrix that couples the vector of white noise sources generated by the control system to achieve the desired reference spectrum.

MIL-STD-810H
METHOD 527.2 ANNEX C

METHOD 527.2, ANNEX C

PROCEDURE I MET (TIME WAVEFORM REPLICATION (TWR) SPECIFIC)

1. PROCEDURE I MET (TIME DOMAIN REFERENCE CRITERIA).

1.1 Preprocessing.

Since placement and orientation of transducers are paramount in the conduct of MDOF MET, performing a thorough pretest review is essential to overall test validity and efficiency. Misalignment of one transducer will adversely affect the transfer function matrix as a whole. To address these types of issues, take detailed measurements and photographs of the actual field setup (i.e., how and where the materiel was mounted) to aid in proper laboratory setup (since the laboratory configuration should mimic the field setup as accurately as possible). In addition, once the test item and associated measurement and control instrumentation are configured in the laboratory, examine phase and coherence measurements between drive channels and control channels to make sure that input points and their resultant responses are logical (e.g., a vertical input should largely affect vertical responses at low frequencies). Also, ensure the spectral characteristics of the control accelerometers and associated signal conditioning equipment have the same frequency response characteristics as that of the instrumentation used to make the original reference measurements, or properly pre-condition data as required to ensure proper phase relationships between channels.

2. ANALYSIS CONSIDERATIONS FOR A PROCEDURE I MET.

2.1 Addressing Translational Motion.

Since linear transducers are generally the measurement transducers of choice, translational measurements will be readily available. One needs only to have a well-defined coordinate system established.

2.2 Addressing Angular Motion.

Auto-Spectral Density (ASD) analysis provides a general spectral view of the reference data; however, it contains no phase information. It is the differences in phase and amplitude between collinear accelerometers that indicate the presence of angular motion. One method of investigating the presence of angular acceleration (either pure or combined with translational acceleration) from a suite of linear accelerometers is to perform complex transfer functions between collinear pairs of linear accelerometers. Subsequently, performing the same transfer function analysis between the same locations in the laboratory provides another metric for measuring the fidelity of the laboratory test. Analyzing the transfer functions corresponding to the field and laboratory measurements often indicates where the mechanical impedance between field and laboratory begin to diverge. Referring back to the ASD measurements, one is able to gain some perspective as to the amount of energy present as a function of frequency, providing perspective into the deviations expected as a result of divergence in mechanical impedance. Similarities between the reference and laboratory transfer functions indicate field and laboratory rotations are also similar.

In an effort to address the actual level and fidelity associated with rotational degrees-of-freedom from a test controlled entirely by feedback obtained from linear accelerometers, computations of angular motion can be developed. Perform computations from both the reference data and corresponding laboratory control accelerometer pairs, and compare results. The computation takes the form of a small angle approximation; however, since the reference plane on which the accelerometer is mounted is actually rotating, there is no computation error as a function of angle as in the case of a fixed plane small angle approximation. To illustrate, consider two linear accelerometers positioned to measure z-axis motion mounted a distance l inches from their relative centerline along the y-axis. An estimate of Roll (Rx) axis angular motion in units of $\frac{rad}{s^2}$ at the centerline between the two transducers can be computed as $\frac{(a_{1z} - a_{2z}) * 386}{2l}$.

Ideally this technique will provide a good metric for analyzing the angular motion for the “rigid body” case. The frequency, at which the field data and laboratory data begin to diverge is an indication of where the mechanical impedance between tactical field mechanical interface and laboratory fixturing begins to differ. The magnitude of the divergence provides some idea of the quality of the impedance match, and provides a key data point in understanding if the test fidelity is sufficient in addressing a test-specific criteria. In general, the instantaneous center of rotation (ICR) may not coincide exactly with the ICR of the test platform, and that the angular motion estimates may, in fact, be vectors that are not perfectly orthogonal with respect to the true axis of rotation. However, as long as the laboratory reference linear accelerometers used to make the angular acceleration estimates correlate to the exact location and phase of the reference measurements, a localized angular motion comparison is still of interest in addressing replication fidelity.

MIL-STD-810H
METHOD 527.2 ANNEX C

If possible, even though it may be band-limited, recommend an angular accelerometer or rate transducer be placed at the midpoint between the linear accelerometers being used to estimate the rotational DOF of interest. The addition of the angular accelerometer will provide a direct measure of ground truth for angular acceleration at a particular point on a structure.

3. TEST TOLERANCES FOR A PROCEDURE I MET.

As discussed in paragraph 4.2.2, at this point in TWR test philosophy, test tolerance specification is not well quantified. However, numerous candidates for quantifying TWR testing are provided in the Annex section of Method 525.2. Each of the metrics addressed in Method 525.2-Annex A for SESA TWR is also applicable to the MDOF case, only the MDOF case will consist of an “array” of reference channels and an “array” of control channels. As is the case for SESA TWR, recommend the reference time histories be segmented into categories of stationary random, shock, or non-stationary, and the tolerance criteria be applied to each segment based on the data classification. For tolerance development purposes for TWR, the tolerances *should not exceed* the tolerances provided in Methods 514.8, 516.8, and 519.8 respectively, for stationary random vibration and mechanical shock categories. The tolerances for the third form of time trace, non-stationary data, are somewhat dependent on the nature of the non-stationarity. Techniques for non-stationarity assessment for which time trace amplitude is a function of both time and frequency are available (see paragraph 6.1, reference d). Some non-stationary time traces that have time invariant frequency characteristics can be represented by the Product Model (PM), and can be processed for tolerance purposes as stationary random vibration with a time-varying envelope. Consult Annexes A and B of Method 525.2 for details of TWR tolerance specification for non-stationary time traces. Finally, in addition to time segmenting the overall reference and control traces, it may be desirable to establish separate test tolerances over common bandwidths of the reference and control time traces, i.e., perform frequency segmenting. This could be accomplished through digital filter scheme. This Method provides no guidance for tolerance development under frequency segmentation.

3.1 Composite (Global) Error Discussion for Procedure I.

One obvious point of concern in addressing adequacy of a 6-DOF TWR test is in a global sense. This is analogous, in the conduct of traditional SDOF testing to the practice of providing a composite control plot summarizing multiple control channel averaging or weighting schemes. For example, experience has shown that in MEMA tests in which a specific mechanical degree-of-freedom consists of a very small percentage of the composite energy across all mechanical degrees-of-freedom, the associated error for that DOF will often be higher than the desired test tolerances discussed in paragraph 3 above. Three candidates, (many others are possible) for accessing global error are addressed in paragraph 6.1, reference k, and summarized below. The three techniques discussed below are consistent with the rudimentary division of data types discussed in Method 525.2, Annex A.

3.2 Global RMS Error.

One of the most common time domain error metrics employed in TWR testing is simply comparisons between the reference data and laboratory data as EU-rms versus time computed over short time slices for the duration of the test. For the MDOF TWR case, the rms versus time error is easily calculated for each control channel as illustrated by Step 2 below. Also of interest would be an energy weighted view of the rms versus time error between the reference and control signals. This concept is developed in the following steps:

- Step 1 The arrays $r_{J \times N}$ and $l_{J \times N}$ shown in Equation 3.2.1 represent, respectively, the N point sampled reference and laboratory test data for each of the J control channels. Test-specific parameters such as sample frequency and filter settings should be tracked by the test operator. It is assumed that the time histories represented by Equation 3.2.1 will not have a bias, or that any bias has been removed during pre-processing.

$$r(n) = \begin{pmatrix} r_1(n) \\ r_2(n) \\ \vdots \\ r_J(n) \end{pmatrix} \quad l(n) = \begin{pmatrix} l_1(n) \\ l_2(n) \\ \vdots \\ l_J(n) \end{pmatrix} \quad n = 1, 2 \dots N; \quad (3.2.1)$$

- Step 2 The two matrices RMS_r and RMS_l shown in Equation 3.2.2 contain the g-rms values for each reference and laboratory test channel computed over each time segment, s . The j index, $j = 1, \dots, J$

MIL-STD-810H
METHOD 527.2 ANNEX C

, represents the control channel number and the s index, $s = 1, \dots, S$, represents the time segment number. For example, if the sample frequency F_s is 1024 Hz, and the rms calculation is to be computed every 0.5 seconds ($M=512$ samples), $s=1$ would represent samples $n = 1 \dots M$, $s=2$ would represent the samples $n = M + 1 \dots 2M$, and so on.

$$RMS_{j \times S} _r = \begin{pmatrix} rms_r_{11} & \dots & rms_r_{1S} \\ \vdots & \ddots & \vdots \\ rms_r_{j1} & \dots & rms_r_{jS} \end{pmatrix} \quad RMS_{j \times S} _l = \begin{pmatrix} rms_l_{11} & \dots & rms_l_{1S} \\ \vdots & \ddots & \vdots \\ rms_l_{j1} & \dots & rms_l_{jS} \end{pmatrix} \quad (3.2.2)$$

$$\text{where, } rms_r_{js} = \sqrt{\frac{1}{M} \sum_{n=(M \cdot s)-M+1}^{M \cdot s} r_j^2(n)} \quad \text{and} \quad rms_l_{js} = \sqrt{\frac{1}{M} \sum_{n=(M \cdot s)-M+1}^{M \cdot s} l_j^2(n)}$$

Step 3 Observing that the columns of the two matrices shown in Equation 3.2.2 represent the reference and laboratory test channels, g-rms values for a given time segment s , it is possible to isolate the individual columns and develop a weighting strategy across all control channels for each time segment. Equation 3.2.3 illustrates a 2-norm computed for each column of the reference matrix RMS_r . Note that post multiplication by indexing vector U_s provides a method of isolating the s^{th} column of interest.

$$nc_rms_r = \left(\|(RMS_r)U_1\|_2, \|(RMS_r)U_2\|_2, \dots, \|(RMS_r)U_S\|_2 \right)$$

$$\text{where, } U_1 = \begin{pmatrix} 1 \\ 0 \\ \vdots \\ 0 \end{pmatrix}, \quad U_2 = \begin{pmatrix} 0 \\ 1 \\ \vdots \\ 0 \end{pmatrix}, \quad \dots, \quad U_S = \begin{pmatrix} 0 \\ 0 \\ \vdots \\ 1 \end{pmatrix} \quad (3.2.3)$$

Step 4 Equation 3.2.4 demonstrates computation of a weighting factor for each entry in the reference matrix RMS_r , based on a column normalization to the corresponding 2-norm computed in Equation 3.2.3. This weighting factor may be considered in addressing rms-error between the reference and laboratory data.

$$Wt_{j \times S} = \begin{pmatrix} \frac{(RMS_r_{11})^2}{(nc_rms_r_1)^2} & \frac{(RMS_r_{12})^2}{(nc_rms_r_2)^2} & \dots & \frac{(RMS_r_{1S})^2}{(nc_rms_r_S)^2} \\ \frac{(RMS_r_{21})^2}{(nc_rms_r_1)^2} & \frac{(RMS_r_{22})^2}{(nc_rms_r_2)^2} & \dots & \frac{(RMS_r_{2S})^2}{(nc_rms_r_S)^2} \\ \vdots & \vdots & \ddots & \vdots \\ \frac{(RMS_r_{j1})^2}{(nc_rms_r_1)^2} & \frac{(RMS_r_{j2})^2}{(nc_rms_r_2)^2} & \dots & \frac{(RMS_r_{jS})^2}{(nc_rms_r_S)^2} \end{pmatrix} \quad (3.2.4)$$

Step 5 The relative error between the reference signals and signals measured during laboratory testing can be computed on a log scale per Equation 3.2.5.

MIL-STD-810H
METHOD 527.2 ANNEX C

$$RMS_{j \times S} \bar{err} = 20 \log_{10} \begin{pmatrix} \left(\frac{RMS_{-l_{11}}}{RMS_{-r_{11}}} \right) & \left(\frac{RMS_{-l_{12}}}{RMS_{-r_{12}}} \right) & \cdots & \left(\frac{RMS_{-l_{1S}}}{RMS_{-r_{1S}}} \right) \\ \left(\frac{RMS_{-l_{21}}}{RMS_{-r_{21}}} \right) & \left(\frac{RMS_{-l_{22}}}{RMS_{-r_{22}}} \right) & \cdots & \left(\frac{RMS_{-l_{2S}}}{RMS_{-r_{2S}}} \right) \\ \vdots & \vdots & \ddots & \vdots \\ \left(\frac{RMS_{-l_{J1}}}{RMS_{-r_{J1}}} \right) & \left(\frac{RMS_{-l_{J2}}}{RMS_{-r_{J2}}} \right) & \cdots & \left(\frac{RMS_{-l_{JS}}}{RMS_{-r_{JS}}} \right) \end{pmatrix} \quad (3.2.5)$$

Step 6 The RMS_{-err} matrix can be normalized by the weighting parameter defined in Matrix Wt as illustrated in Equation 3.2.6.

$$RMS_{j \times S} \bar{Nerr} = \begin{pmatrix} (RMS_{-err_{11}})(Wt_{11}) & (RMS_{-err_{12}})(Wt_{12}) & \cdots & (RMS_{-err_{1S}})(Wt_{1S}) \\ (RMS_{-err_{21}})(Wt_{21}) & (RMS_{-err_{22}})(Wt_{22}) & \cdots & (RMS_{-err_{2S}})(Wt_{2S}) \\ \vdots & \vdots & \ddots & \vdots \\ (RMS_{-err_{J1}})(Wt_{J1}) & (RMS_{-err_{J2}})(Wt_{J2}) & \cdots & (RMS_{-err_{JS}})(Wt_{JS}) \end{pmatrix} \quad (3.2.6)$$

Step 7 A Global-rms error may now be established for each time segment as illustrated in Equation 3.2.7.

$$Glob_{1 \times S} \bar{rms}_{-err} = \left(\sum_{j=1}^J (RMS_{-Nerr})U_1, \cdots, \sum_{j=1}^J (RMS_{-Nerr})U_S \right) \quad (3.2.7)$$

The rms error produced in Step 7 above provides a global perspective to rms error between the reference and laboratory data in which each control location is included and weighted in terms of the energy within each time segment, s .

3.3 Global ASD Error.

One of the most common frequency domain error metrics employed in TWR testing is based upon comparisons of ASD 's computed over a given time segment. The level of non-stationarity of a reference signal and/or similarities in the data over a particular segment of time may be considered in selection of the time segment over which the ASD is computed. While it is certainly easy to argue the usefulness of an ASD estimate of non-stationary data, the technique is still useful in making a direct comparison between field based reference signals and laboratory-based data from a TWR test. A logical division of time segments is to select the segments to be as close to piecewise stationary as possible.

As previously stated, the topic of this document is centered on establishing global performance metrics for the MDOF TWR scenario. The steps that follow outline one technique for consideration in viewing ASD results computed over multiple control channels.

Step 1 The arrays $r_{j \times N}$ and $l_{j \times N}$ shown in Equation 3.3.1 represent respectively, the N point sampled reference and laboratory data for each of the J control channels. Test-specific parameters such as sample frequency, F_s , and filter settings, should be tracked by the test operator. It is assumed that the time histories represented by Equation 3.3.1 will not have a bias, or that any bias has been removed during pre-processing.

$$r(n) = \begin{pmatrix} r_1(n) \\ r_2(n) \\ \vdots \\ r_j(n) \end{pmatrix} \quad l(n) = \begin{pmatrix} l_1(n) \\ l_2(n) \\ \vdots \\ l_j(n) \end{pmatrix} \quad n = 1, 2, \dots, N; \quad (3.3.1)$$

Step 2 The two matrices ASD_{-r_s} and ASD_{-l_s} shown in Equation 3.3.2 represent ASD estimates computed over time segment, s . The j index, $j = 1, \dots, J$, represents the control channel number and

MIL-STD-810H
METHOD 527.2 ANNEX C

the f index, $f = 1, \dots, F$, where $F = \frac{BS}{2}$, represents each spectral line of the ASD estimate. For example, if $Fs = 1024$ and the block-size (BS) used in the estimate of the ASD is set to $BS = 512$, $F = 256$ and the frequency resolution would be $\Delta f = \frac{Fs}{BS} = 2\text{Hz}$. In computing the ASD estimates, the time segment, s , may be either the entire range $n = 1 \dots N$, or some subset thereof.

$$ASD_{\substack{r_s \\ \text{JxF}}}(f) = \begin{pmatrix} asd_{r_{11}} & \dots & asd_{r_{1F}} \\ \vdots & \ddots & \vdots \\ asd_{r_{J1}} & \dots & asd_{r_{JF}} \end{pmatrix} \quad ASD_{\substack{l_s \\ \text{JxF}}} = \begin{pmatrix} asd_{l_{11}} & \dots & asd_{l_{1F}} \\ \vdots & \ddots & \vdots \\ asd_{l_{J1}} & \dots & asd_{l_{JF}} \end{pmatrix} \quad (3.3.2)$$

Step 3 Observing that the columns of the two matrices shown in Equation 3.3.2 represent the reference and laboratory test channels $\frac{G^2}{\text{Hz}}$ values for a given spectral line as estimated over time segment, s , the individual columns can be isolated and a weighting strategy developed across all control channels for each spectral line. Equation 3.3.3 illustrates a 2-norm computed for each column of the reference matrix ASD_{r_s} . Post multiplication by indexing vector, U , provides a method of isolating an individual column of interest.

$$nc_{\substack{asd \\ \text{JxF}}}_{r_s} = \left(\|(ASD_{r_s})U_1\|_2, \|(ASD_{r_s})U_2\|_2, \dots, \|(ASD_{r_s})U_F\|_2 \right)$$

$$\text{where, } U_1 = \begin{pmatrix} 1 \\ 0 \\ \vdots \\ 0 \end{pmatrix}_{F \times 1}, U_2 = \begin{pmatrix} 0 \\ 1 \\ \vdots \\ 0 \end{pmatrix}_{F \times 1}, \dots, U_F = \begin{pmatrix} 0 \\ 0 \\ \vdots \\ 1 \end{pmatrix}_{F \times 1} \quad (3.3.3)$$

Step 4 Equation 3.3.4 demonstrates computation of a weighting factor for each entry in the reference matrix ASD_r based on a column normalization to the corresponding 2-norm computed in Equation 3.3.3.

This weighting factor may be considered in addressing $\frac{G^2}{\text{Hz}}$ error between the reference and laboratory data.

$$Wt_s = \begin{pmatrix} \frac{(ASD_{r_{11}})^2}{(nc_{asd}_{r_1})^2} & \frac{(ASD_{r_{12}})^2}{(nc_{asd}_{r_2})^2} & \dots & \frac{(ASD_{r_{1F}})^2}{(nc_{asd}_{r_F})^2} \\ \frac{(ASD_{r_{21}})^2}{(nc_{asd}_{r_1})^2} & \frac{(ASD_{r_{22}})^2}{(nc_{asd}_{r_2})^2} & \dots & \frac{(ASD_{r_{2F}})^2}{(nc_{asd}_{r_F})^2} \\ \vdots & \vdots & \ddots & \vdots \\ \frac{(ASD_{r_{J1}})^2}{(nc_{asd}_{r_1})^2} & \frac{(ASD_{r_{J2}})^2}{(nc_{asd}_{r_2})^2} & \dots & \frac{(ASD_{r_{JF}})^2}{(nc_{asd}_{r_F})^2} \end{pmatrix} \quad (3.3.4)$$

Step 5 The relative error between the reference signals and signals measured during laboratory testing can be computed on a log scale per Equation 3.3.5.

MIL-STD-810H
METHOD 527.2 ANNEX C

$$ASD_{JxF} \bar{err}_s = 10 \log_{10} \begin{pmatrix} \left(\frac{ASD_{l_{11}}}{ASD_{r_{11}}} \right) & \left(\frac{ASD_{l_{12}}}{ASD_{r_{12}}} \right) & \cdots & \left(\frac{ASD_{l_{1F}}}{ASD_{r_{1F}}} \right) \\ \left(\frac{ASD_{l_{21}}}{ASD_{r_{21}}} \right) & \left(\frac{ASD_{l_{22}}}{ASD_{r_{22}}} \right) & \cdots & \left(\frac{ASD_{l_{2F}}}{ASD_{r_{2F}}} \right) \\ \vdots & \vdots & \ddots & \vdots \\ \left(\frac{ASD_{l_{J1}}}{ASD_{r_{J1}}} \right) & \left(\frac{ASD_{l_{J2}}}{ASD_{r_{J2}}} \right) & \cdots & \left(\frac{ASD_{l_{JF}}}{ASD_{r_{JF}}} \right) \end{pmatrix} \quad (3.3.5)$$

Step 6 The ASD_{err} matrix can be normalized by the weighting parameter defined in Matrix Wt as illustrated in Equation 3.3.6.

$$ASD_{JxF} \bar{Nerr}_s = \begin{pmatrix} (ASD_{err_{11}})(Wt_{11}) & (ASD_{err_{12}})(Wt_{12}) & \cdots & (ASD_{err_{1F}})(Wt_{1F}) \\ (ASD_{err_{21}})(Wt_{21}) & (ASD_{err_{22}})(Wt_{22}) & \cdots & (ASD_{err_{2F}})(Wt_{2F}) \\ \vdots & \vdots & \ddots & \vdots \\ (ASD_{err_{J1}})(Wt_{J1}) & (ASD_{err_{J2}})(Wt_{J2}) & \cdots & (ASD_{err_{JF}})(Wt_{JF}) \end{pmatrix} \quad (3.3.6)$$

Step 7 A Global ASD error may now be established for each time segment, s , as illustrated in Equation 3.3.7.

$$Glob_{JxF} \bar{asd}_{err}_s = \left(\sum_{j=1}^J (ASD_{Nerr})U_1, \cdots, \sum_{j=1}^J (ASD_{Nerr})U_F \right) \quad (3.3.7)$$

The ASD error spectrum produced in Step 7 above provides a global perspective to ASD error between the reference and laboratory data in which each control location is included, and weighted in terms of the energy at each spectral line.

3.4 Global SRS Error.

As discussed in Method 525.2, significant transients that can be identified within a reference time trace may be analyzed post-test using traditional SRS or pseudo velocity SRS analysis. A global error technique for SRS analysis can be developed with a slight variation of the ASD approach defined in paragraph 3.3 above. Specifically, as a substitute for indexing on a frequency line basis, index frequency on a 1/12th octave basis using maxi-max acceleration within each 1/12th octave band.

MIL-STD-810H
METHOD 527.2 ANNEX D

METHOD 527.2, ANNEX D

PROCEDURE II MET (SPECTRAL DENSITY MATRIX (SDM) SPECIFIC)

1. PROCEDURE II MET (FREQUENCY DOMAIN REFERENCE CRITERIA).

1.1 Preprocessing.

Since placement and orientation of transducers are paramount in the conduct of MDOF MET, performing a thorough pretest review is essential to overall test validity and efficiency. Misalignment of one transducer will adversely affect the transfer function matrix as a whole. To address these types of issues, take detailed measurements and photographs of the actual setup (i.e., how and where the item was mounted) to aid in proper laboratory setup (since it should mimic the field setup as accurately as possible). In addition, once the test item and associated measurement and control instrumentation are configured in the laboratory, examine phase and coherence measurements between drive channels and control channels to make sure that input points and their resultant responses are logical (e.g., a vertical input should largely affect vertical responses at low frequencies). Ensure the spectral characteristics of the control accelerometers and associated signal conditioning equipment have the same spectral characteristics of the instrumentation used to make the original reference measurements, or properly pre-condition data as required, to ensure proper phase relationships between channels. Also, it is highly recommended that an FEM model of the MET configuration be developed. A prior knowledge of the modal characteristics of a laboratory-based MET system often proves to be of great value in addressing undesired modal response through implementation of additional feedback to be considered in the control scheme.

2. ANALYSIS CONSIDERATIONS FOR A PROCEDURE II MET.

2.1 MESA and MEMA Specification Parameters.

The classical metrics addressed in Method 514.8 for control of SESA vibration tests are insufficient for the analysis of a MET. In the conduct of either a MESA or MEMA Procedure II vibration test, both auto-spectral density (ASD) and cross-spectral density (CSD) terms are required test parameters. As one would expect, the configuration of a MET will influence the reference spectral requirements. For example, consider defining a random test for the two MET systems illustrated in Figures 527.2-2 and 527.2-3. Table 527.2D-I illustrates a spectral density matrix (SDM) construct, the 2-DOF MET shown in Figure 527.2-2 and similarly, Table 527.2D-II illustrates the format of spectral information required in specifying the 3-DOF MET of the system shown in Figure 527.2-3. Observe that the format of a Spectral Density Matrix (SDM) consists of auto-spectral density (power spectral density) terms on the diagonal and cross-spectral density terms on the off-diagonal. Also, note the Hermitian structure for the case in which the SDM is square.

Table 527.2D-I. Reference criteria for a 2-DOF linear motion random MET.

$ASD_{z1z1}(f)$	$CSD_{z1z2}^*(f)$
$CSD_{z1z2}(f)$	$ASD_{z2z2}(f)$

Table 527.2D-II. Reference criteria for a 3-DOF linear motion random MET.

$ASD_{xx}(f)$	$CSD_{xy}^*(f)$	$CSD_{xz}^*(f)$
$CSD_{xy}(f)$	$ASD_{yy}(f)$	$CSD_{yz}^*(f)$
$CSD_{xz}(f)$	$CSD_{yz}(f)$	$ASD_{zz}(f)$

Ideally, field measurements will be available to define both auto and cross spectral densities. One note regarding the development of vibration criteria for a Procedure II MET is that, unlike the SESA case, it is difficult to develop a

MIL-STD-810H
METHOD 527.2 ANNEX D

composite set of reference spectra for a MEMA test. The difficulty lies primarily in the inability to characterize the CSD terms across an ensemble of measurements. This issue is discussed in further detail in Annex E.

2.1.1 Cross Spectral Density Structure.

Most of the commercially available MET control systems provide a method of entering the CSD terms in the form of relative phase and coherence. For example, if one wished to conduct a vertical only test using the two-exciter configuration illustrated in Figure 527.2-2, the ideal reference would be a phase setting of 0 degrees with a coherence of 1.0. Similarly, if the motion desired was pure pitch, the ideal reference would be a phase setting of 180 degrees with a coherence of 1.0. Unfortunately, selecting a coherence setting of 1.0 results in a singular SDM. Furthermore, it is very rare to find perfectly coherent measurements in practice due to noise and system non-linearities. Experience has shown that when specifying highly coherent measurements in a MET, a coherence selection that is slightly less than 1.0, ($\gamma_{ij} = .95$ to $.98$), greatly reduces the numerical concerns associated with a singular SDM, and the desired frequency and temporal characteristics are still achieved to a high degree.

Direct knowledge of the CSD characteristics of the field environment is desired as the phasing characteristics between mechanical DOF's may have a significant effect on the response of the UUT. Modal characteristics of the UUT may highly influence response dynamics as a function of the relative phasing of the reference (drive) signals.

2.2 Control Hierarchy.

In earlier MET control algorithms as discussed in paragraph 6.1, reference h, in the hierarchy of control for a MET, correction of the ASD terms were generally given priority. CSD terms were then corrected to the degree possible without corrupting the ASD terms. In modern MET algorithms, the drive signals are updated such that the SDM matrix has minimal mean-squared error. The degree of accuracy in replicating the CSD terms in a MEMA test are often test-specific, and associated tolerances should be tailored as appropriate. For example, consider a 6-DOF MET designed to address functional performance of a component such as a gimble-based stabilization platform for which one may have interest in the rotational degrees of freedom to a frequency that is much less than the full test bandwidth. For such cases, maintaining accurate CSD characteristics between control points will be predefined by the test performance objectives and the CSD characteristics at frequencies higher than the bandwidth of the required functional test are not considered critical.

2.2.1 Measured Data Available.

When in-service measurement data have been obtained, it is assumed that the data are processed in accordance with good data analysis procedures (see paragraph 6.1, references d and e). In particular, an adequate number of statistical degrees-of-freedom has been obtained to provide information with acceptable statistical error. Generally, careful attention must be given to the field measurement configuration. In particular, the location of the measurement points and qualification of the points as to whether they are structural points on the materiel capable of describing overall vibration characteristics of the materiel, or are response points on the materiel local to specific component response definition of the materiel. Consideration must be given to not only statistical error in auto-spectral density estimates, but also in cross-spectral density estimates (including transfer, coherence function estimates). For cross-spectral density transfer function estimates, it is important to correctly diagnose the coherence or lack of coherence among measurements. Ideally, the field and laboratory phase and coherence would match, implying an accurate match of boundary conditions. However, in practice this is rarely the case. Inspection of the field measured CSD terms is recommended to select key frequency bands in which one desires optimal coherence and phase matching as discussed in reference 19 of Annex E.

Low coherence implies that the vibration energy between measurements is uncorrelated, so that multiple exciters may be employed without cross-spectral information. Low coherence may also be viewed as a relaxation of strict cross-spectral information and perhaps use of the cross-spectral information that occurs naturally in the laboratory test configuration.

2.2.2 Measured Data Not Available.

When measurement data are not available and only specification level auto-spectral density information is available, it almost always needs to be assumed that excitation environments are independent of one another (coherence values are near zero). In addition, the effects of in-service and laboratory boundary condition impedance cannot be assessed. Normal mode information from the materiel is important in allowing the general decoupling of vibration modes of response. Careful attention must be given to the specification of the "control" and "monitoring" measurement points.

MIL-STD-810H
METHOD 527.2 ANNEX D

A control measurement point would typically be on a structural member and describe the overall vibration characteristics of the item. A monitoring measurement point would describe local vibration characteristics that are relevant for a specific component. Paragraph 6.1, reference j, provides information on extremes of excitation.

2.2.3 Use of 1-DOF References.

Employing highly conservative vibration specifications originally designed for a 1-DOF laboratory test as uncorrelated reference ASD's for a MDOF test should be addressed with caution. Vibration specifications developed for 1-DOF scenarios are often purposely conservative, in part to account for the fact that no significant coupling between mechanical DOF's is expected in the laboratory. However, such coupling between mechanical DOF's is certainly possible in the field or in a MDOF laboratory setting. Therefore, employing highly conservative spectra as references in a MDOF test could yield uncharacteristically high response in the event the unit under test has closely coupled structural modes between mechanical DOF's. If the conservatism characteristics of the 1-DOF references are clearly defined, it may be possible to develop an alternative set of uncorrelated references with reduced conservatism to address MDOF scenarios.

3. TEST TOLERANCES FOR A PROCEDURE II MET.

In general, all test tolerances need to be established based on some comparison in the frequency domain of the auto-spectral and cross-spectral density specifications with the corresponding laboratory test measured auto-spectral and cross-spectral information. Substantial reliance with respect to tolerances will be made on the auto-spectral density information, with cross-spectral density information playing a secondary role because of its reliance on measurement channel coherence for error characterization. Basic comparison might be taken for nominal test tolerances performed by the vendor-supplied MET software. Test laboratory personnel need to consult the vendor-supplied MET system manuals for such tolerances, and have a very clear understanding of the proper interpretation of the test tolerances. Unfortunately, the question of reasonable tolerances in a MET is not simple. Generally, the test tolerances prescribed in Method 514.8 for stationary random vibration are applicable for auto-spectral density information derived from a MET. However, it is often necessary to relax test tolerances on cross-spectral density information. Transfer function estimates along with coherence, partial coherence and multiple coherence function estimates may be necessary to assess the test tolerance questions. An experienced analyst will be required in cases where multi-channel measurements must be assessed for test tolerance assessment.

Since the test is run in real time, it is only necessary to ensure the reference input is properly compensated before running the test. All MET strategies and vendor software provide for very low level testing for establishing preliminary transfer function information that may be updated for higher level testing. The updated transfer function accounts for certain vibration system amplitude nonlinearities that may occur as the general level of vibration is increased.

3.1 Composite (Global) Error Discussion for Procedure II.

The same issues discussed in Annex C, paragraph 3.1, apply to Procedure II MET. However, for a Procedure II test, the time histories synthesized by the control system will be wide sense stationary and Gaussian in nature. Therefore, the global error discussion reduces to a discussion of the ASD and CSD error. Recall from the discussion in paragraph 2.2, that ASD is given priority in the control scheme, and that the degree of CSD accuracy required will be determined largely on a test-by-test basis. Addressing global error will depend largely on the MET configuration and control transducer placement. Translational and rotational degrees of freedom may be viewed in a composite sense by averaging or weighting each transducer in a common axis, or possibly by considering the composite ASD error across all axes as suggested in Annex C, paragraph 3.3. Translational degrees of freedom are readily computed from direct accelerometer measurements, while rotational degrees of freedom may be viewed in terms of the ASD computed from either direct angular motion measurements or from estimates of rotations computed from linear accelerometers. When considering estimates of rotational degrees of freedom based on linear accelerometers, refer to the guidance and caution discussed in Annex C, paragraph 2.2.

MIL-STD-810H
METHOD 527.2 ANNEX D

(This page is intentionally blank.)

MIL-STD-810H
METHOD 527.2 ANNEX E**METHOD 527.2, ANNEX E****LABORATORY VIBRATION TEST SCHEDULE DEVELOPMENT
FOR MULTI-EXCITER APPLICATIONS****1. SCOPE.**

This Annex presents considerations and techniques for developing Laboratory Vibration Test Schedules (LVTS) that can be utilized to simulate field vibration environments on a vibration table. Laboratory vibration tests are used extensively in lieu of more time-consuming and less cost effective field exposure tests. This Annex specifically addresses random vibration testing controlled to frequency-domain vibration spectra and is intended to address multiple “exciter” (also referred to as “shaker” or “actuator”) scenarios with the emphasis on mechanical multiple degree-of-freedom (MDOF) scenarios. There is a significant increase in complexity between single-exciter/single-axis (SESA) and multiple-exciter/multiple-axis (MEMA) testing in terms of both mechanics and control. MEMA specific issues ranging from definitions and nomenclature consistency, to data analysis techniques, will be addressed.

2. FACILITIES AND INSTRUMENTATION.**2.1 Facilities.**

The development of a LVTS will require access to the test item of interest (or a dynamically equivalent surrogate), access to the carrier vehicle, appropriately placed transducers, signal conditioning and data acquisition hardware, and a controlled environment for collecting input data (e.g., a road course for wheeled and/or tracked vehicles, waterway for watercraft, airspace for aircraft, rotorcraft, and/or spacecraft).

2.2 Instrumentation.

- a. LVTSs are generally defined in terms of acceleration units. The transducer of choice for making acceleration measurements is an accelerometer. This Annex will address LVTS development in terms of acceleration.
- b. It is strongly recommended that the same model of accelerometer and signal conditioning is employed at all instrumented locations to preserve phase characteristics during both the field acquisition and laboratory test phase of any MDOF test. Refer to the guidelines in Military Standard (MIL-STD)-810H^{1*} and Institute of Environmental Sciences and Technology (IEST) Recommended Practice IEST-RP-DTE012.2² for recommended accuracy of the transducers and associated signal conditioning.

3. REQUIRED TEST CONDITIONS.

The primary function of Vibration Schedule Development (VSD) is to combine vibration measurements of numerous events that collectively represent an item’s lifetime vibration exposure (or some predefined subset thereof) into a manageable set of LVTS representing the equivalent exposure. The most dynamically accurate method to reproduce the full exposure would be to sequentially vibrate the system to all the individual, uncompressed events representing its full lifecycle. However, such an approach is generally not feasible from both schedule and economic perspectives and some compromises must be made to realize the benefits of testing in the laboratory. Time compression techniques based on fatigue equivalency are typically employed such that vibration testing can be performed in a timely and economic manner. North Atlantic Treaty Organization (NATO) Allied Environmental Conditions Test Publication (AECTP) 240, Leaflet 2410³ and Method 514.8 of Mil-Std-810H, provide general guidance for developing accurate representations, and issues that should be considered during the VSD process for the SESA scenario. This Annex expands upon the discussion in Leaflet 2410 to address the general multiple exciter test scenario. Discussions will be limited to random LVTS development. At the time of this publication, no commercially available multiple-input multiple-output (MIMO) solutions exist for swept narrowband random on random (NBROR) or sine-on-random (SOR) other than Procedure I - Time Waveform Replication based techniques.

3.1. Test Configurations.

The MIMO random vibration test problem can refer to several configurations. One configuration is multiple exciters driving a single test item in one axis. This configuration is often used for large test items too large for a single exciter. A second configuration is the excitation of a single test item with multiple exciters in more than one axis. Linear displacements along defined directions are referred to as translation degree-of-freedom (DOF) and angular displacements along those same directions are referred to as rotation DOFs. Up to six DOFs exist for a rigid body

*Superscript numbers correspond to those in Appendix E, References.

MIL-STD-810H
METHOD 527.2 ANNEX E

(i.e., X-, Y-, Z-translations and roll, pitch, yaw rotations). In some cases, additional DOFs can be excited due to deformations of the test article and/or testing an item with articulating components.

3.1.1 Basic Representation of a MIMO System.

All MIMO test systems are discussed using a common description in terms of matrix equations^{2,4,5}. A simplified version of the general MIMO random vibration test problem can be generalized in Figure 1. The complete mechanical system is characterized by the power amplifiers and a system of several exciters, on which is mounted a single test article. The response of the test article is monitored by a vector of response channels (represented as $\{c\}$). Each element in the vector is typically the acceleration time history from a single accelerometer. Other types of sensors can be used, with attention paid to the nature of the measurements relative to the test item and other sensors. The power amplifiers are driven by a vector of electrical drives (represented as $\{d\}$), generated by a control system. Each element in the vector is a time history driving a single shaker. The control system monitors the response of the test item $\{c\}$, and attempts to produce drive signals $\{d\}$, such that the statistics of the control signals meet some criteria as specified in the test specifications.

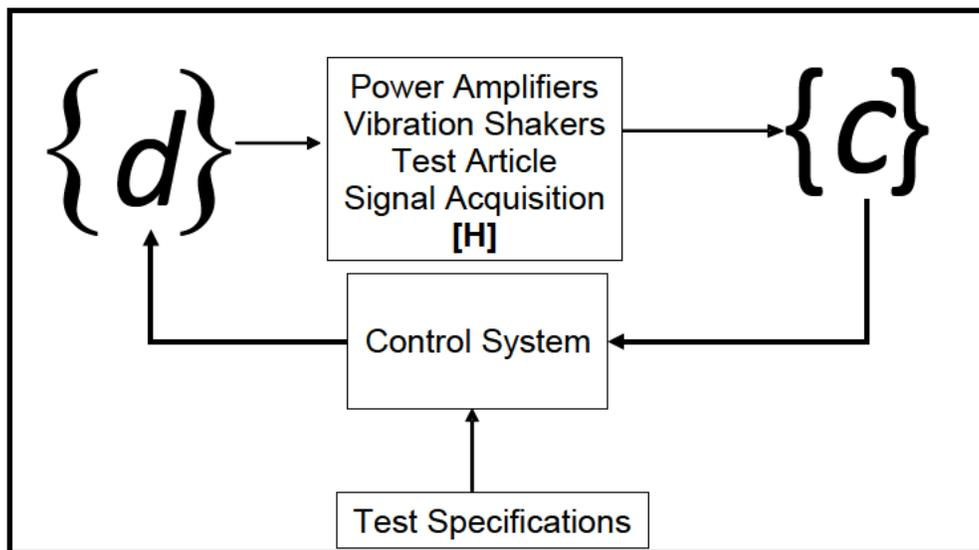


Figure 1. Basic representation of a MDOF system.

3.1.2 Generalized Representation of a MIMO System.

A more generalized MIMO system is shown in Figure 2. A system under test is driven by N_s shakers resulting in the response of N_a control accelerometers. The accelerometer data are typically structured in blocks. Each of the acceleration records will then be a vector of time samples. Some control systems then provide for a transformation matrix, T_a , to convert the block of N_a accelerometer time histories to N_c control variables. The Spectral Density Matrix (SDM) of the control variables is then estimated from the current block of data and previous data. The transformation matrix, T_a , is typically a constant independent of frequency. In theory the transformation matrix could be applied before or after the estimation of the control SDM. The estimated control SDM, C is then compared with the reference SDM, R , and a correction is computed for the drive SDM, D . The drive time histories $\{d\}$ are then computed from the drive SDM, D , using time domain randomization. A second transformation matrix, T_s , is employed to transform the N_d drive variables into N_s shaker drive signals. In theory, T_s could be implemented before or after the transformation into the time domain. One advantage of placing the transformation in the frequency domain section of the control algorithm is that the matrix could then be made a function of frequency. Having the transformation matrix, T_s , a constant assumes the shakers are matched and the desired transformation can be deduced.

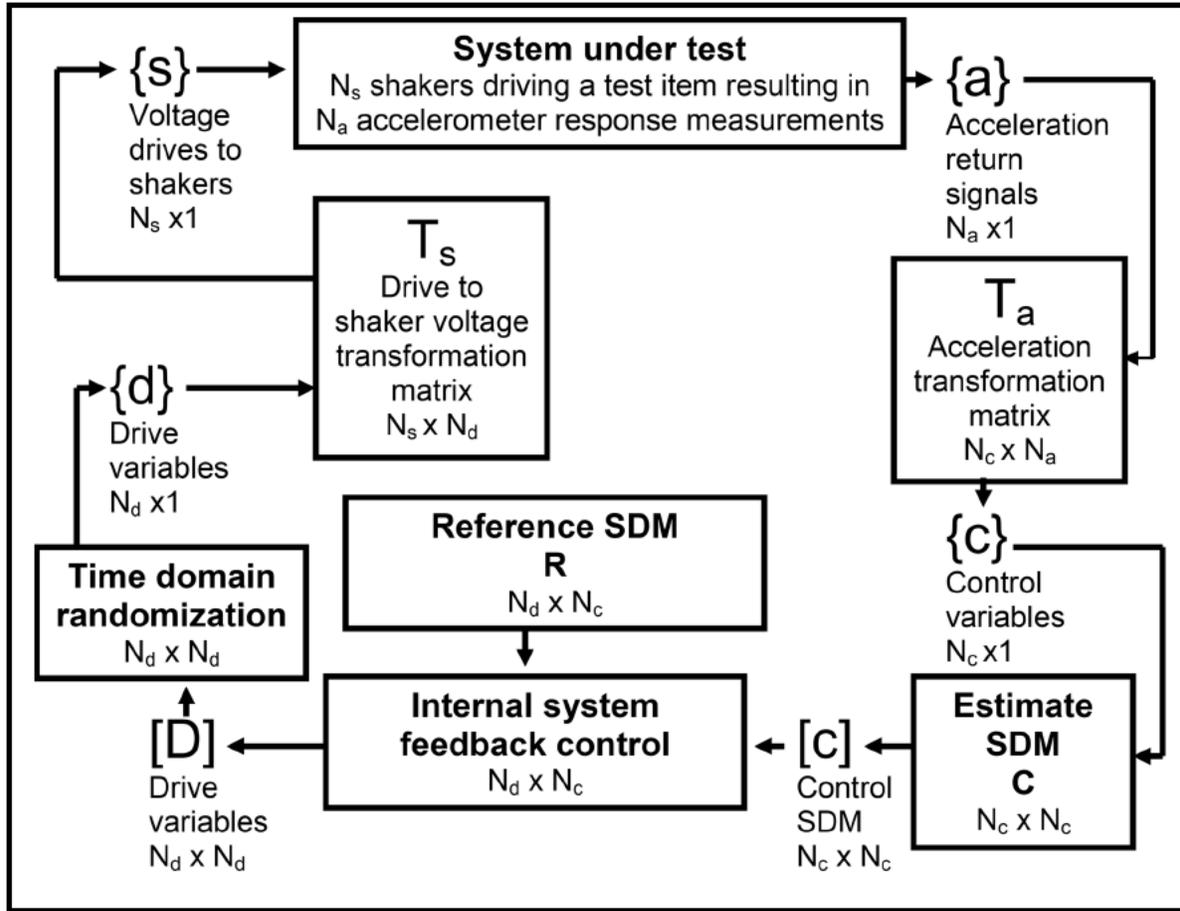
MIL-STD-810H
METHOD 527.2 ANNEX E

Figure 2. Generalized representation of a MDOF system.

3.2 Generalized MDOF Vibration Control Discussion.

- a. A general discussion of the MDOF control process is provided for insight as to how the MDOF LVTS will serve as the reference in the control process. The purpose of the control loop is to minimize the difference between the reference and the control signals by making corrections to the drive signals. The correction can be computed in several ways. One method is to compute the drive from:

$$D = \hat{Z}RZ'$$

where the system impedance matrix, Z , is updated as new information is gathered, or a modified reference spectrum, \hat{R} , is computed based on the error in the return spectrum. The initial drive vector is typically computed using the above equation and the reference SDM. A drive signal error can also be computed from:

$$D_e = Z(R - C)Z'$$

Sometimes an adaptive correction is used. Sometimes a combination of all methods is used.

- b. The transformation matrices are often called the input and output transformation matrices. One should be careful with this nomenclature because of the confusion between input and output. The input to the system under test (voltages to the power amplifiers or servo controllers) is the output of the control system. The output of the system under test (such as accelerometer measurements) is the input to the control system. Paragraphs 4.4.1 and 4.4.2 provide the nomenclature employed for input and output transformations, as they are applied within this document.

MIL-STD-810H
METHOD 527.2 ANNEX E

- c. Minor errors in the matching of shakers can be corrected by the control algorithm, but major mismatches could be problematic. The time domain drive signals (represented by $\{s\}$), are sent to the shakers completing the control loop.
- d. If \mathbf{T}_a is not available, then $N_a = N_c$ and $\{a\} = \{c\}$. If \mathbf{T}_s is not available, then $N_d = N_s$ and $\{d\} = \{s\}$. If $N_d = N_c$, the number of control variables and the number of drive variables are the same. This is referred to as square control. Square control is the most common control method. If $N_s > N_a$ the system is over-actuated and least squares approach using a pseudo inverse (pinv) is typically used to determine the drive signals. If $N_s < N_a$ the system is under-actuated and exact control of the control SDM is often not possible. In such cases, some kind of average control is usually implemented. Often when $N_s \neq N_a$ some combination of the transformation matrices are often used to force square control, $N_d = N_c$.
- e. The entire mechanical system can be characterized by a matrix of frequency response functions $[\mathbf{H}]$. For the typical case, these frequency response functions will have units of g/V (acceleration in gravitational units/volts of drive). For the typical case, the control signals are characterized by a SDM. The diagonal elements are the autospectral density (ASD or PSD) of the control signals. The off diagonal elements are the cross spectral densities (CSD) between pairs of control signals. The input to the system is characterized by the SDM of the voltage drive signals. The fundamental relationship between the drives and the control signals is given by:

$$\mathbf{C} = \mathbf{H}\mathbf{D}\mathbf{H}'$$

- f. The complex conjugate transpose is denoted by $[\]'$. All of the matrices in the equation are complex functions of frequency. The spectral density matrix is Hermitian⁶, i.e. $D_{ij} = D_{ji}^*$ where D_{ji}^* is the complex conjugate of D_{ji} , and D_{ji} is an element from a spectral density matrix. Note that this requirement demands that the diagonal elements are real. Note that C and D are square matrices; they have the same number of rows and columns. C and D are the same size only if H is square, i.e. the same number of inputs and outputs. To be physically realizable, the SDM must also be positive semi-definite. This requirement will be discussed in paragraph 4.5.2.
- g. The drive spectral density matrix is converted into the drive time histories using the method of time domain randomization⁴. The spectral density matrix is typically estimated using Welch's method⁷.

4. TEST PROCEDURES.

VSD requires a thorough knowledge of the dynamic environment to which the test hardware will be exposed when fielded. This knowledge must include characterization of the exposure levels and durations for all relevant conditions.

4.1 Development of Mission or Lifetime Scenario.

The duration of the vibration environments can be derived from the item's Life Cycle Environment Profile (LCEP). The life cycle will include many different types of induced mechanical environments which may occur while the materiel is being handled, transported, deployed and operated. Although all the induced mechanical environments are not critical in terms of generating potential damaging response amplitudes, they contribute in varying degrees to the materiel's fatigue damage. All expected exposure conditions should be tabulated, along with corresponding durations, to form the items lifetime "scenario". The scenario is a key parameter in the development of any vibration schedule.

4.2 Limitations.

The mechanical degrees of freedom (DOFs) for which a VSD effort is capable of addressing, is a function of the number and placement of the transducers employed in the field data acquisition phase. Similarly, the maximum number of mechanical DOFs possible to reproduce in the laboratory environment is a function of the number and placement of actuators and coupling hardware. This Annex will consider the general case for VSD development in which the reference SDM will be defined in terms of the six classical (3-translational and 3-rotational) rigid body mechanical DOFs. In the event less than six mechanical DOFs are being considered, the generalized theory is easily configured to address the motion of interest.

MIL-STD-810H
METHOD 527.2 ANNEX E

4.3 Field Data Acquisition.

When in-service measurement data have been obtained, it is assumed that the data is processed in accordance with good data analysis procedures, as in Multi-Shaker Test and Control IEST-RP-DTE022.1⁸ and Welch's method. In particular, an adequate number of statistical degrees of freedom (DOFs) have been obtained to provide information with acceptable statistical error. Consideration must be given to not only statistical error in auto-spectral density estimates, but also in cross-spectral density estimates (including transfer and coherence function estimates).

4.3.1 Instrumentation.

For the purpose of this Annex, all instrumentation related discussions will be limited to linear accelerometers and engineering units of g's, as was the case in the general control discussion provided in paragraph 3.1.1. Linear accelerometers have several advantages including familiarity to most users, low cost, wide bandwidth, small size and weight, and readily available low cost highly reliable signal conditioning options.

4.4 Use of Rigid Body Modes.

- a. In single axis testing, the control input is often defined with a single accelerometer. This is satisfactory if the shaker and test fixtures are rigid within the frequency band of interest. If the shaker and test fixtures are not rigid, the technique of using a single accelerometer for control can sometimes lead to serious difficulty. To overcome these problems, methods using the average of several accelerometers and/or force limiting have come into common practice. In MEMA testing, the problem can be more serious as non-rigid body response is more common. When considering the special case of multiple shakers exciting a test item with multiple rigid body degrees of freedom, the use of the input transformation to define the response in terms of rigid body modes has several advantages. It is somewhat analogous to a generalization of the common practice for single axis testing. If there are more control channels than rigid body degrees of freedom, and an input transformation matrix is defined to transform the control accelerometers into rigid body modes, one essentially defines the motion of each rigid body mode as a weighted average of the accelerometers active for the mode. In many cases, given the control authority of the shakers, this is about the best viable solution. It is analogous to averaging accelerometers for a single axis test, which is common practice. The elastic modes are not controlled, since often the control authority over these modes does not exist. The system is driven with an equivalent rigid body motion in each of the rigid body modes. It is necessary to make sure that for any mode the transformation of the control accelerometers {a} does not result in zero for any of the rigid body modes. If higher flexural modes are present they will not be controlled. In theory the flexural modes can be limited by adding control variables, but this requires knowledge of the modes in the test setup. This information can only be determined with materiel in the test configuration. For this reason, it is sometimes desirable to allow modification of the test requirements after this information is made available. Exactly how this will be accomplished in specification writing will have to be determined at a later date.
- b. An advantage of using rigid body modes in the specification is that the field measurements used to define the environment can be made with the transducers in locations different from the locations of the transducers used in the laboratory test. The field measurements are reduced to equivalent rigid body modes using an acceleration transformation matrix (refer to paragraph 4.4.1), and the modes are controlled on the test using another transformation matrix for the laboratory test configuration. The two transformation matrices do not have to be the same. Use of alternate control points, while maintaining a full rank transformation matrix, provides a way of making the laboratory test "equivalent" in the sense of the rigid body modes.
- c. A practical difficulty arises when more modes are attempted to be controlled. The general case of six (6) rigid body modes requires the specification of a 6 x 6 SDM (6 ASD's and 15 CSD's). Physical understanding of the SDM matrix associated with rigid-body motion by itself is difficult without the additional complications of elastic DOFs. Furthermore, it is difficult to assure that the specification results in a positive definite SDM, which is a physical requirement. (Additional discussion on positive definite matrices is the subject of paragraph 4.5.2.)

4.4.1 Acceleration (Input) Transformation.

The acceleration to control space transformation matrix, \mathbf{T}_a , commonly referred to as the "input transformation matrix" from the control system perspective, is defined in the article "Applying Coordinate Transformations to Multi-DOF Shaker Control"⁹ and generalized in the article "Benefits and Challenges of Over-Actuated Excitation Systems"¹⁰. The acceleration transformation matrix transforms a set of accelerometer measurements into a set of

MIL-STD-810H
METHOD 527.2 ANNEX E

control variables. Often these control variables are descriptions of rigid body modes. The acceleration transformation is usually performed in the time domain as:

$$\{\mathbf{c}\} = \mathbf{T}_a \{\mathbf{a}\}$$

4.4.1.1 Acceleration (Input) Transformation Derivation.

One goal of this Annex is to define a standard nomenclature. The following summary has been restructured to the nomenclature defined by this Annex. Referring to the input transformation derivation¹⁰, a generic acceleration measurement at the k^{th} position in orientation j is structured as Equation 4.1:

$$a_{k_j} = \begin{bmatrix} \underline{e}_j^T & -\underline{e}_j^T \left[\begin{smallmatrix} P \\ \underline{r}_i \end{smallmatrix} \right]^\times \end{bmatrix} \begin{bmatrix} \begin{smallmatrix} P \\ \underline{a}_o \end{smallmatrix} \\ \begin{smallmatrix} P \\ \underline{\alpha} \end{smallmatrix} \end{bmatrix} \quad (4.1)$$

where a_0 is the linear acceleration at some reference point designated the “origin”, α is the angular acceleration of the body (assuming it is rigid), $k \in (1, 2, \dots, N_a)$, $i \in (1, 2, \dots, n^*)$, $j \in (x, y, z)$, and $\underline{e}_x^T = [1 \ 0 \ 0]$, $\underline{e}_y^T = [0 \ 1 \ 0]$, and $\underline{e}_z^T = [0 \ 0 \ 1]$ are row selection vectors (as shown assuming accelerometer orientation is aligned per a traditional right hand Cartesian system). Parameter N_a represents the number of accelerometer measurements (as previously defined) and $n^* \leq N_a$ the number of measurement locations; e.g., utilization of multi-axis accelerometers results in $n^* < N_a$. Vector r_i is the position vector relating the position of measurement location i to a user defined origin. $\left[\begin{smallmatrix} P \\ \underline{r}_i \end{smallmatrix} \right]^\times$ is the skew symmetric operator equivalent of the cross product, making the matrix based computations in Equation 4.1 possible. The matrix equivalent of a vector (i.e., a coordinatized vector quantity) is denoted as $\begin{pmatrix} \end{pmatrix} \begin{pmatrix} \end{pmatrix} \begin{pmatrix} \end{pmatrix}$ where the right superscript and subscript identify the body and point of interest respectively, and the left superscript denotes the coordinate frame in which the vector quantity was coordinatized; e.g., $\begin{smallmatrix} P \\ \underline{r}_i \end{smallmatrix}$ in Equation 4.1 denotes the i^{th} point on body P (the platform) coordinatized in frame \mathcal{F}_P - the platform’s coordinate frame.

4.4.1.2 Equation 4.1.

Equation 4.1 represents one equation in six unknowns, the three components of the linear acceleration of the reference point and the three components of the rigid body angular acceleration. In order to determine these quantities, at least six measurements are needed. These requirements are not as stringent as that reported in the article “On the Use of Linear Accelerometers in Six-DOF Laboratory Motion Replication”¹¹ because of the assumptions above (i.e., small angular velocities and rigid body).

MIL-STD-810H
METHOD 527.2 ANNEX E

Let's consider the most general case of N_a measurements from n^* locations. In this case, Equation 4.1 becomes:

$$\begin{bmatrix} a_{1j} \\ a_{2j} \\ \vdots \\ a_{n_j} \end{bmatrix}_{(n \times 1)} = \begin{bmatrix} \underline{e}_j^T & -\underline{e}_j^T \begin{bmatrix} P & P \\ r_1^P & \end{bmatrix}^{\times} \\ \underline{e}_j^T & -\underline{e}_j^T \begin{bmatrix} P & P \\ r_i^P & \end{bmatrix}^{\times} \\ \vdots & \vdots \\ \underline{e}_j^T & -\underline{e}_j^T \begin{bmatrix} P & P \\ r_{n^*}^P & \end{bmatrix}^{\times} \end{bmatrix}_{(n \times 6)} \begin{bmatrix} \underline{a}_o^P \\ \underline{\alpha}^P \end{bmatrix}_{(6 \times 1)}, \quad i \in (1, 2, \dots, n^*), j \in (x, y, z)$$

which using the nomenclature defined in this Annex is of the form:

$$\{\mathbf{a}\}_{\text{Meas}} = [\bar{\mathbf{T}}_a] \{\mathbf{c}\}_{\text{Motion}} \quad (4.2)$$

$(n \times 1) \quad (n \times 6) \quad (6 \times 1)$

where $\{\mathbf{c}\}_{\text{Motion}}$ is a 6 x 1 matrix of unknown linear and angular accelerations and $\{\mathbf{a}\}_{\text{Meas}}$ is an $n \times 1$ matrix of acceleration measurements. Observe that $[\bar{\mathbf{T}}_a]$ is entirely defined by knowledge of (i) placement, (ii) orientation, and (iii) utilized signals of the accelerometers.

Observe that if $\bar{\mathbf{T}}_a$ is of full column rank, then $[\bar{\mathbf{T}}_a^T \bar{\mathbf{T}}_a]^{-1}$ exists enabling $\{\mathbf{c}\}_{\text{Motion}}$ to be solved as follows:

$$\begin{aligned} \{\mathbf{a}\}_{\text{Meas}} &= \bar{\mathbf{T}}_a \{\mathbf{c}\}_{\text{Motion}} \\ \bar{\mathbf{T}}_a^T \{\mathbf{a}\}_{\text{Meas}} &= \bar{\mathbf{T}}_a^T \bar{\mathbf{T}}_a \{\mathbf{c}\}_{\text{Motion}} \\ [\bar{\mathbf{T}}_a^T \bar{\mathbf{T}}_a]^{-1} \bar{\mathbf{T}}_a^T \{\mathbf{a}\}_{\text{Meas}} &= [\bar{\mathbf{T}}_a^T \bar{\mathbf{T}}_a]^{-1} \bar{\mathbf{T}}_a^T \bar{\mathbf{T}}_a \{\mathbf{c}\}_{\text{Motion}} \\ [\bar{\mathbf{T}}_a^T \bar{\mathbf{T}}_a]^{-1} \bar{\mathbf{T}}_a^T \{\mathbf{a}\}_{\text{Meas}} &= \{\mathbf{c}\}_{\text{Motion}} \end{aligned}$$

Defining $\mathbf{T}_a \equiv [\bar{\mathbf{T}}_a^T \bar{\mathbf{T}}_a]^{-1} \bar{\mathbf{T}}_a^T$, Equation 4.2 can be rewritten as:

$$\{\mathbf{c}\}_{\text{Motion}} = [\mathbf{T}_a] \{\mathbf{a}\}_{\text{Meas}} \quad (4.3)$$

Where $[\mathbf{T}_a]$ is a 6 x n matrix referred to in the literature as the “Acceleration Transform Matrix” or “Input Transform Matrix”. Observe that the critical requirement that $[\bar{\mathbf{T}}_a^T \bar{\mathbf{T}}_a]^{-1}$ exists in order to derive the input transformation matrix $[\mathbf{T}_a]$, is solely a function of placement and orientation of measurement transducers.

4.4.2 Drive (Output) Transformation.

- a. Although details of the Drive Transformation are not required to develop a MDOF VSD reference, a short summary of the concept is provided for general knowledge. Referring to the schematic in Figure 2, transformation matrix \mathbf{T}_s transforms the N_d drive variables into N_s shaker drive signals. Reference 10 provides a formal derivation of the transformation matrix, \mathbf{T}_s . Note that while the “acceleration transformation” was computed based on knowledge of position and polarity of the control accelerometers, the transformation matrix, \mathbf{T}_s is dependent upon the position and line of action (LOA) of the individual actuators. In this Annex and within reference 10 \mathbf{T}_s is referred to as the “drive transformation” or “output transformation”. The following cases summarize the computation of \mathbf{T}_s and the effect on the control process.

MIL-STD-810H
METHOD 527.2 ANNEX E

- (1) Case 1: Configurations in which the number of motion degrees-of-freedom or control signals, N_c and the number of output control variables, N_d are the same is referred to as “square” control. If the number of output control variables, N_d and the number of shakers, N_s is the same, the transformation matrix, T_s will simply be the Identity matrix.
 - (2) Case 2: Configurations in which the number of shakers N_s exceeds the number of output control variables N_d , the excitation system is said to be over-determined or over-actuated. In such cases, some of the drives will be linear combinations of other drives. Furthermore, if T_s is a constant which is employed in the time domain, the individual actuators must be matched (e.g. matched frequency response functions (FRFs)).
 - (3) Case 3: Configurations in which the number of shakers, N_s is less than the number of control signals, N_c , the excitation system is said to be under-determined or under-actuated. In such cases, exact control of the SDM is not possible.
- b. In theory, T_s could be implemented before or after the transformation into the time domain. One advantage of placing the transformation in the frequency domain section of the control algorithm is that the matrix could then be made a function of frequency. Having the transformation matrix, T_s , a constant assumes the shakers are matched and the desired transformation can be deduced.

4.4.2.1 Drive (Output) Transformation Derivation.

- a. As previously stated, one goal of this Annex is to recommend a standard nomenclature. The following summary from reference number 10 has been restructured to the nomenclature recommended by this Annex. Figure 3 illustrates the generalized multi-axis vibration system.

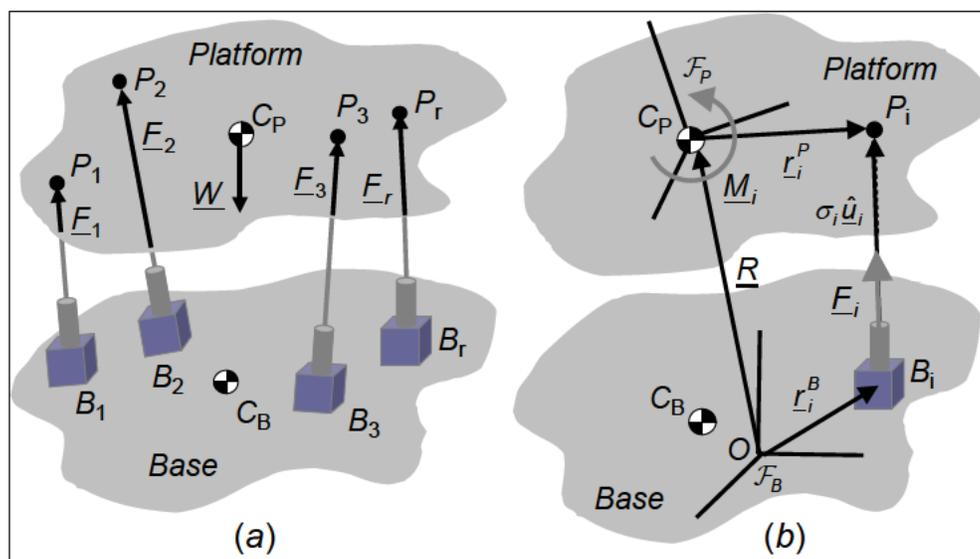


Figure 3. Generalized multi-axis vibration system.

- b. Refer to reference number 10 for a detailed derivation of Equation 4.4. The following summary illustrates how the output transform, T_s is associated with the P-Matrix, (Plucker Matrix) discussed in the reference.

MIL-STD-810H
METHOD 527.2 ANNEX E

$$\begin{bmatrix} {}^B \hat{\underline{u}}_1 & {}^B \hat{\underline{u}}_2 & \cdots & {}^B \hat{\underline{u}}_{N_s} \\ {}^P \underline{m}_1 & {}^P \underline{m}_2 & \cdots & {}^P \underline{m}_{N_s} \end{bmatrix} \begin{bmatrix} f_1 \\ f_2 \\ \vdots \\ f_{N_s} \end{bmatrix} = \begin{bmatrix} m \left({}^B \underline{a}_C^P - {}^B \underline{g} \right) - {}^B \underline{F}_E \\ {}^P \underline{I}_C^P \dot{\underline{\omega}}^P + \left[\underline{\omega}^P \right]^\times {}^P \underline{I}_C^P \left({}^P \underline{\omega}^P \right) - {}^P \underline{M}_E \end{bmatrix} \quad (4.4)$$

\mathbf{P} \mathbf{F} \mathbf{C}
 $6 \times N_s$ $N_s \times 1$ 6×1

- c. In Equation 4.4, $[\mathbf{P}]$ represents the Plucker Matrix which is derived from known geometric parameters associated with the individual actuators, $[\mathbf{F}]$ represents the drive and $[\mathbf{C}]$ represents the desired motion. The variables ${}^B \hat{\underline{u}}_i$ represent the LOA vectors for each of the actuators and ${}^P \underline{m}_i$ is the moment arm associated with force f_i . Observe that the maximum dimension for the $[\mathbf{C}]$ matrix will be six, if all six traditional motion DOFs are being considered (i.e. $N_d = 6$). As stated in paragraph 4.4.2, Case 1 scenarios will simply have an identity matrix as the output transformation matrix and Case 3 scenarios (under-actuated) will not have a unique solution. Case 2 scenarios (over-actuated) may be addressed in terms of output transformations. The objective is to determine $[\mathbf{F}]$ in Equation 4.4, yielding the N_s drive signals as follows:

(1) Define $\mathbf{F} \equiv \mathbf{P}^T \mathbf{D}$ and substitute into $\mathbf{P} \mathbf{F} = \mathbf{C}$ yielding $\mathbf{P} \mathbf{P}^T \mathbf{D} = \mathbf{C}$

$N_s \times 1$ $N_s \times 6$ 6×1 $6 \times N_s$ $N_s \times 1$ 6×1 $6 \times N_s$ $N_s \times 6$ 6×1 6×1

(2) $\mathbf{P} \mathbf{P}^T$ will be of full rank (i.e. invertible) if $[\mathbf{P}]$ is of full rank.

$6 \times N_s$ $N_s \times 6$

(a) If $[\mathbf{P}]$ is of full rank: $\mathbf{D} = \left[\mathbf{P} \mathbf{P}^T \right]^{-1} \mathbf{C}$

6×1 $6 \times N_s$ $N_s \times 6$ 6×1

- (b) If $[\mathbf{P}]$ is not full rank, actuator placement is not sufficient to obtain the mechanical DOF's desired.

(3) Substituting results from (2) yields $\mathbf{F} \equiv \mathbf{P}^T \mathbf{D} = \mathbf{P}^T \left[\mathbf{P} \mathbf{P}^T \right]^{-1} \mathbf{C}$

$N_s \times 1$ $N_s \times 6$ 6×1 $N_s \times 6$ $6 \times N_s$ $N_s \times 6$ 6×1

(4) $\mathbf{T}_s \equiv \mathbf{P}^T \left[\mathbf{P} \mathbf{P}^T \right]^{-1}$

$N_s \times 6$ $N_s \times 6$ $6 \times N_s$ $N_s \times 6$

- d. The discussions within this paragraph and previous derivation assumed $N_d = 6$. In the event $N_d < 6$, N_d would represent the actual number of mechanical DOFs. In terms of the nomenclature of Figure 2, and assuming matched actuators are employed, voltage drives to the shakers for the over-actuated scenario would be defined as Equation 4.5:

$$\{\mathbf{s}\} = \mathbf{T}_s \{\mathbf{d}\} \quad (4.5)$$

4.5 Data Analysis.

- a. Ensure transducer placements have been addressed, to guarantee the desired motion DOFs may be resolved (refer to paragraph 4.4.1.2), and that common data validity checks are performed. Then, it is recommended that appropriate combinations of the linear acceleration measurements be transformed into the desired traditional motion DOFs through implementation of the acceleration transformation matrix. The transformed

MIL-STD-810H
METHOD 527.2 ANNEX E

time histories will be referenced to a single point on the structure referred to as the “origin” as discussed in paragraph 4.4.1.

- b. A SDM for each test configuration identified in the mission scenario should be computed. In addressing the VSD techniques for reducing an ensemble of data, in this case an ensemble of SDM's, the analyst will be required to deal with the ASD terms (the diagonal terms of the SDM) and CSD terms (the off-diagonal terms of the SDM).

4.5.1 Phase and Coherence Based Representations of CSD Terms.

Although the off-diagonal terms of the SDM are computed in terms of a CSD, it is common among control system vendors to allow cross terms to be defined in terms of Phase and Coherence. This is a convenient option in that it is often easier to physically interpret SDM CSD terms in terms of Phase and Coherence. There is a direct relationship between the two techniques of defining the cross terms of the SDM that is dependent upon the definition of ordinary

coherence between two signals, $\gamma_{ij}^2 = \frac{|G_{ij}|^2}{G_{ii}G_{jj}}$. Normalizing the CSD terms of the SDM by $\sqrt{G_{ii}G_{jj}}$ yields a normalized spectral density matrix (SDM_n) in which the ASD terms are not affected and the magnitude of the normalized CSD terms are defined as $\frac{G_{ij}}{\sqrt{G_{ii}G_{jj}}}$, which is equivalent to the square root of the ordinary coherence

function, while not affecting the original phase relationship of the CSD terms. Similarly, the normalized spectral density matrix, SDM_n, may be transformed back to the original CSD form of the SDM.

4.5.2 Positive Definite SDM Considerations.

- a. Any specified spectral density matrix must be positive semi-definite to be physically realizable. In practice it must be positive definite. The determinate of the matrix must be ≥ 0 . All the eigenvalues of the SDM must be ≥ 0 . This must be true at all frequencies. It must be possible to perform a Cholesky decomposition of the specified SDM. Another property of positive semi definite matrices is from Matrix Computations¹²:

$$|\Phi_{ij}|^2 \leq \Phi_{ii}\Phi_{jj} \quad \text{or} \quad 0 \leq \gamma^2 = \frac{|\Phi_{ij}|^2}{\Phi_{ii}\Phi_{jj}} \leq 1$$

In the terms of random vibrations the ordinary coherence, γ^2 between signals must be less than or equal to one. In practical terms, if the coherence between any pair of signals is one, the SDM will be positive semi-definite and the control system will have problems. Note that in general, if \mathbf{D} is Hermitian and positive semi-definite \mathbf{C} will also be Hermitian and positive semi-definite.

- b. If all the eigenvalues are non-negative, the matrix is positive semi-definite. If any of the eigenvalues are zero, it implies that one or more of the rows of the spectral density matrix are a linear combination of other rows. In practice, one would typically expect to deal only with positive definite matrices. Observe that even a small amount of noise or nonlinearity will result in a positive definite matrix. If a matrix is positive definite, the matrix can always be factored using Cholesky decomposition,

$$\Phi = \mathbf{L}\mathbf{L}'$$

where \mathbf{L} is a lower triangular matrix. Which without loss of generality can be rewritten as,

$$\Phi = \mathbf{L}\mathbf{I}\mathbf{L}'$$

where \mathbf{I} is the identity matrix. In this application, \mathbf{I} is not really the identity matrix. \mathbf{I} is a spectral density matrix. At every frequency, \mathbf{I} is a diagonal matrix of ones. The components in \mathbf{I} are independent since all the off diagonal elements are zero. It is now clear why the cross spectral density matrix must be positive definite. If any of the elements in \mathbf{I} are zero, it implies that there are less than N (the number of rows or columns in Φ) independent sources in Φ . Some of the rows and columns are linear combinations of other rows and columns. The identity matrix is positive definite, therefore Φ must be positive definite. Using the interpretation of Random Data Analysis and Measurement Procedures¹³, the diagonal elements of \mathbf{I} can be

MIL-STD-810H
METHOD 527.2 ANNEX E

interpreted as the auto-spectral densities of independent random noise sources. The maximum number of independent noise sources is N . If some of the elements in \mathbf{I} are zero, the problem can still be solved by making the corresponding rows and columns of \mathbf{L} zero. This is the positive semi-definite case. This case corresponds to the case where there exists less than N independent sources. Some of the N sources are linear combinations of other sources. This case will be very difficult for the control system. In general one may make some of the sources small but not zero. Part of this document will discuss the generation of a desired control SDM to make the control problem achievable and hopefully relatively easy for the control system to implement.

- c. In general the control problem is an inverse problem. The desired control SDM (the output of the system under test) is known, and the drive (input to the system under test) SDM must be computed. There is a potential point of confusion here. The control system manufacturers treat the drive SDM as the output of the control system, which is the input to the shaker system. Similarly, the control system input is the output of the shaker system. Paragraphs 4.4.1 and 4.4.2 provide nomenclature employed for input and output transformations as they are applied within this document.
- d. Inverse problems can be very difficult as multiplication by a matrix inverse is required. If the matrix is ill-conditioned, the result will be similar to dividing by zero for the scalar case.

For the case in which the number of inputs and outputs are the same; \mathbf{H} is a square matrix of FRF's. The solution is to invert \mathbf{H} . The solution for the drive matrix is then given by:

$$\mathbf{Z} = \mathbf{H}^{-1}$$

$$\mathbf{D} = \mathbf{Z}\mathbf{R}\mathbf{Z}'$$

This of course assumes \mathbf{H} is well conditioned and the inverse exists. Part of this document will discuss issues to help the process of achieving a well conditioned \mathbf{H} matrix.

The \mathbf{H} matrix is typically estimated from:

$$\hat{\mathbf{H}} = \hat{\mathbf{S}}_{\text{CD}} \hat{\mathbf{D}}^{-1}$$

The inverse of $\hat{\mathbf{D}}$ must exist. This implies that $\hat{\mathbf{D}}$ must be positive definite. The initial estimate of \mathbf{H} is determined by exciting the system with a set of independent white inputs in a pretest environment. If \mathbf{H} is to be corrected during the test, $\hat{\mathbf{D}}$ must be positive definite during the test or special provisions must be used to avoid the inversion of $\hat{\mathbf{D}}$ at frequencies where $\hat{\mathbf{D}}$ is not positive definite. This is one of the reasons the reference \mathbf{R} rarely has any of the coherences equal to unity.

4.5.3 Data Compression.

- a. Use of time compression techniques such as Miner-Palmgren may be employed to modify the ASD terms. References numbers 1 and 3 provide discussions on time compression. In the simplest terms, the Miner-Palmgren Hypothesis (Miner's rule) is a set of mathematical equations used to scale vibration spectra levels and their associated test times. It provides a convenient means to analyze fatigue damage resulting from cyclical stressing. The mathematical expression and variable descriptions for this technique are illustrated in Equation 4.6:

$$\frac{t_2}{t_1} = \left[\frac{S_1}{S_2} \right]^M \quad (4.6)$$

where:

t_1 = equivalent test time

t_2 = in-service time for specified condition

MIL-STD-810H
METHOD 527.2 ANNEX E

S_1 = severity (root mean square ((rms)) at test condition

S_2 = severity (rms) at in-service condition

(The ratio S_1/S_2 is commonly known as the exaggeration factor.)

M = a value based on (but not equal to) the slope of the S-N curve for the appropriate material where S represents the stress amplitude and N represents the mean number of constant amplitude load applications expected to cause failure. For the MDOF VSD work at hand, the default of $M = 7$ was selected per reference number 1.

- b. It is recommended that the final vibration specification ASD terms are no greater than 3 decibel (dB) higher than maximum values measured in the field. Miner-Palmgren will be employed to the ASD portion of the SDM in the same manner as one would employ for a traditional 1-DOF scenario. Details such as maintain common test durations between mechanical DOFs are addressed in Paragraph 6.

4.5.4 Limiting Strategies.

Traditional notching techniques may also be employed if impedance mismatches lead to unrealistically high test item response. Notching techniques may be employed across all actuators with equal weighting or by weighting notching at each actuator as a function of coherence between the actuators and the location of interest. In addition to traditional notching based on acceleration spectra, it is also possible to consider limiting based on other parameters (e.g. von Mises Stress or Force limiting). As with any notching scheme, it is critical that any resulting deviations to the test or test tolerances must be approved by the appropriate test authority and must be clearly documented in the test plan and final report.

4.5.5 Minimum Drive Considerations.

A number of challenges have been identified in addressing the objective of establishing a reference SDM for multiple exciter test (MET) scenarios. One major area of concern is related to the fact that it is highly likely that there will be mechanical impedance differences between the field and laboratory conditions. Given these impedance mismatch issues, it is undesirable to force the test item into what could potentially be an unnatural state as fixtured in the laboratory. Optimally, achieving the specified autospectra without excessively taxing the excitation system is desired. Smallwood made a general approach to establishing minimum drive criteria in the article "MIMO Linear Systems Extreme Inputs/Outputs"¹⁴. Unfortunately, the technique does not always guarantee the resulting SDM to be positive semi-definite.

4.5.5.1 Independent Drives.

- a. Although an active area of research, general techniques to address minimum drive criteria have not been formally established at the time of this publication. A proposed approach for trending drive voltages towards minimums while maintaining a positive- definite SDM, is discussed in the article "A Proposed Method to Generate a Spectral Density Matrix for a MIMO Vibration Test"¹⁵, and is summarized below:
- (1) Taking a clue from the modal test community, assume the drive signals to the excitation system will be uncorrelated. Typically for a vibration test, the drives are the voltage inputs to the shakers. For a simulation, the inputs into a model are often forces. It is always possible to excite the system with uncorrelated inputs. This is standard practice in the modal community, and is standard practice when performing the system identification for MIMO test systems. This leads to the logical question: Is it possible to generate a set of uncorrelated inputs that will produce a desired set of response autospectra (the diagonal of the output SDM)?
 - (2) The general equation relating the control point accelerations to the drive voltages is given in Random Vibrations, Theory and Practice¹⁶:

$$\mathbf{S}_Y = \mathbf{H}\mathbf{S}_X\mathbf{H}'$$

where \mathbf{H}' is the conjugate transpose of \mathbf{H} , and \mathbf{S}_X and \mathbf{S}_Y are SDM's. \mathbf{H} is a matrix of frequency response functions relating the output to the input of the excitation system. In our case, ideally, \mathbf{S}_X will be a diagonal matrix. Let $\bar{\mathbf{X}}$ be a column vector of the diagonal of \mathbf{S}_X or, $\bar{\mathbf{X}} = \text{diag}(\mathbf{S}_X)$, and

MIL-STD-810H
METHOD 527.2 ANNEX E

$\bar{\mathbf{Y}} = \text{diag}(\mathbf{S}_{\mathbf{Y}})$. The relationship between the autospectra, as shown in Appendix D proof 1, is given by:

$$\bar{\mathbf{Y}} = \bar{\mathbf{H}}\bar{\mathbf{X}}$$

where:

$$\bar{\mathbf{H}} = \mathbf{H} * \text{conj}(\mathbf{H})$$

where: * indicates an element by element multiplication. $\bar{H}_{ij} = |H_{ij}|^2$.

The solution is given by:

$$\bar{\mathbf{X}} = \bar{\mathbf{H}}^{-1}\bar{\mathbf{Y}}$$

- b. In some cases the result will include negative elements in $\bar{\mathbf{X}}$. This is not physically possible. It indicates that the desired ASD's cannot be achieved with independent drives. In this case the negative values are set to zero, and the output SDM is recomputed from $\mathbf{S}_{\mathbf{Y}} = \mathbf{H}\mathbf{S}_{\mathbf{X}}\mathbf{H}'$ using the modified input spectral density matrix (the negative values set to zero). The resulting control point acceleration autospectra, will not be at the desired levels. To correct this problem, the control point acceleration autospectra are rescaled to the desired levels, keeping the phase and ordinary coherence the same. This is accomplished by pre and post multiplying the SDM by a diagonal matrix whose elements are the square root of the ratio of the desired ASD to the computed ASD:

$$\mathbf{S}_{\mathbf{Y}_{\text{new}}} = \mathbf{S}_s \mathbf{S}_{\mathbf{Y}_{\text{old}}} \mathbf{S}_s$$

where \mathbf{S}_s is a diagonal matrix and:

$$S_{s,ii} = \sqrt{\frac{Y_{ii,\text{new}}}{Y_{ii,\text{old}}}}$$

Note: Setting $S_{Y_{ii,\text{new}}}=1$, provides an efficient way to compute the normalized SDM where the diagonals are one and the magnitude of the off diagonals squared are the ordinary coherence and the phase of the off diagonal elements is the phase of the cross spectra.

The drive SDM can then be computed as:

$$\mathbf{S}_{\mathbf{X}_{\text{new}}} = \mathbf{Z}\mathbf{S}_{\mathbf{Y}_{\text{new}}}\mathbf{Z}'$$

where $\mathbf{Z} = \text{pinv}(\mathbf{H})$, the Moore-Penrose pseudo inverse. If \mathbf{H} is square and full rank, the solution typically ends here. If \mathbf{H} is not square or not full ranked:

$$\mathbf{S}_{\mathbf{Y}_{\text{new}}} = \mathbf{H}\mathbf{S}_{\mathbf{X}_{\text{new}}}\mathbf{H}'$$

The $\text{diag}(\mathbf{S}_{\mathbf{Y}_{\text{new}}})$ may not yield the desired ASD's. In this case, an iterative approach will often improve the result.

4.6 Independent References.

- a. It is sometimes desirable to define the reference spectrum in terms of a diagonal matrix of autospectra. Several reasons drive us in this direction. One common case is that only knowledge of the autospectra from the field environments is available. Several factors can result in this situation. First the field data may have been acquired without phase information. Second, the resulting cross spectra can have a very complicated structure which is impractical to implement in a specification. Enveloping amplitudes is possible, but enveloping the phase is much more difficult. Third, the specification may be a composite of several environments, making the definition of cross spectra very difficult. Fourth, the vehicle on which the field

MIL-STD-810H
METHOD 527.2 ANNEX E

data were taken may not be identical to the test vehicle. Fifth, the boundary conditions in the field may be different from the boundary conditions in the laboratory.

- b. Small changes in the modal frequencies caused by any of the above factors can change the phase at any frequency near a mode by a large amount. All these factors make the specification of the cross spectra difficult. An option is to ignore the cross spectra and set them all to zero. This has the theoretical advantage of providing an excitation that in some sense covers the control variable response space.
- c. The drive signals can readily be computed yielding uncorrelated motion (in this case the SDM of the uncorrelated reference spectra \mathbf{Y} is diagonal) from:

$$\mathbf{S}_{\mathbf{x}0} = \mathbf{Z}\mathbf{S}_{\mathbf{y}0}\mathbf{Z}'$$

This approach is currently available in commercial control systems. You simply specify the reference SDM as a diagonal matrix with the cross spectra (or equivalently the coherences) zero or near zero. This is typically a conservative approach.

- d. In contrast to the independent drive discussion in paragraph 4.5.5.1, the danger with the independent reference concept is that this specification of control variables may be overly conservative near frequencies dominated by a single mode. An important clue that the result may be overly conservative is the trace of the drive voltages. This trace should be monitored and if overly large in some band of frequencies, limits can be negotiated and implemented.

4.7 Recommended Practices Summary.

The following list provides recommendations and general guidance to be considered when addressing the multi-axis VSD.

- a. If possible, specify the test in terms of the rigid body motion.
- b. Over specification of the control accelerometers is desirable. Use more control accelerometers than degrees of freedom in the test.
- c. If possible, the entire SDM should be specified. A method to automate the generation of envelopes may be desired. This will permit the generation of the envelopes to be less developer specific.
- d. If the entire SDM is specified, it is suggested that the coherence be set to near zero if the desired coherence is below 0.2. It should be recognized that the estimation of coherence is a biased result (the result will always be positive). It is recognized that the estimated coherence will never be zero; however, the control software can attempt to make the coherence as low as possible. The tolerance on the coherence must recognize the bias. If the coherence is small the phase is not important. For convenience, establishing a zero phase is a reasonable specification when the coherence is low.
- e. If step c becomes too complicated, it is recommended that the test be run with near zero coherence.
- f. If step e results in unrealistic responses, try using the independent drive option.
- g. Consider a compromise position between independent reference criteria of step e and independent drive criteria as recommended in step f.
- h. If the drive requirements are excessive at some frequencies, allow the test to be modified to reduce the drive requirements as discussed in paragraphs 4.5.4 and 4.5.5.
- i. It is understood that MIMO testing is more complicated than single-input single output (SISO) testing. The specifications must reflect the desires of a knowledgeable environmental test engineer. Good communication between the project team, the environmental test engineer and the test lab must be maintained to achieve the desired test results.

MIL-STD-810H
METHOD 527.2 ANNEX E

5. DATA REQUIRED.

As discussed in NATO AECTP Leaflet 2410³, field data must be acquired based upon the anticipated mission scenario of the unit under test (UUT). As detailed in paragraph 4.4.1.1 and reference number 1, transducer placement and orientation are critical and must be thoroughly documented.

5.1 Reference SDM Development.

As stated in paragraph 4.5, a SDM in terms of the desired rigid body modes to be tested should be computed for each test configuration identified in the mission scenario.

5.1.1 SDM Ensemble CSD Characteristics.

Based on the characteristics of the CSD terms of the ensemble of SDMs, the VSD process will yield a vibration specification consistent with one of the three cases that follow:

- a. Case 1. Coherence Terms Approaching Zero (Independent Motion DOFs) – This is the easiest situation to deal with in that each motion DOF ASD may be addressed individually via the same techniques employed in 1-DOF VSD as discussed in reference number 3. When programming the vibration control system, it is recommended that coherence be set to a low non-zero level (i.e. $\gamma^2 = 0.1$) over the test bandwidth of interest. For such a small coherence, the phase parameter is essentially a random variable and establishing a phase specification is not required.

A special situation that may lead an analyst to develop a MDOF vibration specification with independent motion DOFs, would be a composite specification that encompasses multiple vehicles (i.e. a composite wheeled vehicle specifications comparable to those in MIL-STD-810H, Method 514.8). As each vehicle will tend to have its own CSD characteristics, it is not possible to define CSD terms such that a single coherence and phase relationship addresses each vehicle. Enveloping techniques that work well in addressing magnitude based ASD terms are simply not applicable in addressing phase relationships between mechanical DOFs.

- b. Case 2. Non-Zero Coherence across a Portion of the Test Bandwidth – When developing a MDOF vibration specification based on a single platform, one would expect the CSD terms measured across the range of scenarios addressed in the mission scenario to be similar in nature. The dynamic characteristics of the structure and often the proximity of the measurement transducers will greatly influence the CSD characteristics. There are often situations in which coherence between motion DOFs are high and phase is well defined, but only over a portion of the test spectrum. This is a common observation on many wheeled vehicles where coherence is high at lower frequencies (i.e. frequencies below 50 Hertz (Hz) and near zero at higher frequencies. In such scenarios, one would only establish coherence and phase specifications for the portion of the spectrum with high coherence. The remainder of the spectrum would be treated as in Case 1. Also, in establishing CSD reference criteria, the analyst must ensure the resulting criteria is physically realizable (refer to paragraph 4.5.3 for additional detail).
- c. Case 3. Non-Zero Coherence across the Full Test Bandwidth – This scenario is comparable to Case 2 with coherence being defined across the entire test bandwidth. It is anticipated that this would be the least likely scenario in a MDOF VSD effort. However, it is also the configuration that will be the most difficult to deal with from both a VSD development aspect and from an implementation perspective. In addition to the issue of ensuring the resulting SDM reference is physically realizable, the classic problem of mechanical impedance mismatch between field and laboratory are often major concerns in implementing a fully defined SDM reference criterion for a laboratory test. Specifically, if the mechanical impedance between field and laboratory are not very well matched (and they usually are not), there may be portions of the spectrum in which coherence may be significantly different than specified and simply not controllable. While this situation is also possible in Case 2, it is almost certain to be an issue in a scenario such as Case 3, in which the entire test bandwidth has a CSD reference criteria. This topic of uncontrollable coherence associated with mechanical impedance mismatches is a control issue for all three Cases and is discussed further in the minimum drive consideration of paragraph 4.5.6.
- d. Regardless of which of the three cases the SDM is characterized by, it is highly likely that there will be mechanical impedance differences between the field and laboratory conditions. In some cases these impedance differences may result in excessive drive signals. Although the various control system vendors

MIL-STD-810H
METHOD 527.2 ANNEX E

address this situation in varying degrees, it may still be necessary to address this issue through test operator intervention via techniques such as those identified in paragraphs 4.5.4 and 4.5.5.

5.2 Test Tolerance Recommendations.

Setting tolerances for a MIMO test is challenging given the large amount of information encompassed by the reference autospectra and cross spectra involved. Additionally, the overall energy is not necessarily distributed evenly about each mechanical DOF and dominant DOFs often tend to dominate the control. The objective here is to establish a reasonable starting point in establishing test tolerances. Experience with specific test configurations may be employed to refine the basic guidance defined below. As usual, any test specific test tolerances should be clearly documented within the test plan.

- a. Autospectra⁽¹⁾: $\pm 3 \text{ dB}$ for $f \leq 500 \text{ Hz}$ and $\pm 6 \text{ dB}$ for $f > 500 \text{ Hz}$.

⁽¹⁾The portion of the spectrum that actually reaches the maximum tolerance limits is anticipated in narrow bandwidths. The tolerance on the overall Grms level of each controlled DOF shall be within $\pm 15\%$ of the corresponding reference.

- b. Cross spectra: Define tolerances in terms of Phase and Coherence. Note that there will be a statistical variation of coherence and phase estimates as a function of the statistical DOFs used to estimate the control SDM and also as a function of the coherence between inputs. Take caution in that the expected statistical variation imposes a lower limit on how tight the respective tolerance can be. The coherence and phase guidance given below should be used in the absence of tolerances determined from field environments and necessary margin needed to account for laboratory and in-field service mechanical impedance mismatches. Note that there may be scenarios in which coherence and phase tolerances need not be defined for the entire test bandwidth.¹⁹

(1) Coherence: For ordinary coherence in the range $0.5 \leq \gamma^2 < 1.0$, set the tolerance to be ± 0.1 (avoid establishing a coherence reference or tolerance of 1.0).

(2) Phase: If $\gamma^2 < 0.5$, any phase is acceptable. If $0.5 \leq \gamma^2 < 1.0$ and the frequency f is within the band $f_h \pm 3\Delta f$ where f_h is a frequency where the reference rate of phase change is more than $10^\circ / \text{Hz}$ and Δf is the line spacing of the reference spectra, the default tolerance on phase will be $\pm 40^\circ$. Otherwise, if outside of a frequency band referenced with such high rates phase change, the default tolerance on phase will be $\pm 10^\circ$.

- c. Limiting: See paragraph 4.5.4.

5.3 Laboratory Data.

In the case the reference SDM is directly employed as the reference in a MET test (i.e. input/output (I/O) Transformation Control as discussed in reference number 9), and rigid body presumptions are sound, the control accelerometers are not required to be placed in the exact same location in the laboratory as they were used in the original acquisition phase. The critical parameter is that all control locations employed in the laboratory test are referenced to the same "origin" as selected in the original VSD development. However, it is often desirable, based on making position specific comparisons between field and laboratory data, to match the laboratory control locations to the original measurement points.

6. MDOF VSD METHODS.

6.1 Options Considered.

Having reviewed the data acquisition and analysis requirements, this section is dedicated to defining the steps for two candidate MDOF VSD methodologies¹⁷. Method I is processed in the SDM domain and Method II conducts averaging steps in the Cholesky Domain. An example follows in paragraph 6.3.

6.1.1 Method I.

The following is a 10 step outline of Method I (SDM Domain) MDOF VSD:

- Step 1 Prepare to convert field measurements into motion DOFs.

MIL-STD-810H
METHOD 527.2 ANNEX E

Identify position vectors $r_1 - r_n$ and row selection vectors θ_j as defined in paragraph 4.4.1.1, corresponding to the field measurements.

Identify the mission scenario.

Identify the frequency bandwidth of interest.

Identify the sampling frequency of the field measurements.

Step 2 Transform the field measurements into motion DOF's per equation (4.3) for each "Run" identified in the mission scenario.

Step 3 Compute the SDM for each run identified in Step 2. The dimension of the resulting SDM's will be $[6 \times 6 \times d]$, where d is the number of spectral lines being considered to address the frequency bandwidth of interest.

Since the SDM is computed from measured field data, it should be positive definite; however, a check should be performed to verify that each individual SDM is positive definite. This serves as an excellent data quality check.

Refer to the guidance in Step 7 if minor corrections are required to force an individual SDM to be positive definite.

Step 4 Convert the CSD terms (the off-diagonal terms of the SDM) into a normalized form in which the magnitude squared of the cross terms correlates to the ordinary coherence while leaving the phase unchanged.

This is accomplished by normalizing (dividing) the CSD terms by $\sqrt{G_{xx}G_{yy}}$.

While it is not absolutely necessary to conduct this step, it is often easier to understand the physical meaning of the CSD terms when viewed in terms of phase and coherence.

Step 5 Either organize all of the SDM's for the Runs of interest into a logical structure or merge them into one file of known matrix structure such as $[SDM_Run1, SDM_Run2, \dots, SDM_RunN]$ to optimize the conduct of basic statistics.

Step 6 Compute a weighted average SDM of the N SDM's of Step 5.

It is critical that the weighted average be performed on the true complex CSD terms (**not** the normalized SDM).

The weighting factor on the average will be directly correlated to the mission scenario times identified in Step 1. If the individual Runs are positive definite, the resulting average should also be positive definite. However, numerical issues may yield non-positive definite results. To minimize numerical issues, average only the lower triangular portion of the SDM and fill in the upper triangular portion of the SDM by taking advantage of the Hermitian structure of the matrix [16].

Any type of enveloping operation should be avoided as it is highly likely to yield a non-positive definite result.

Step 7 As SDM data are manipulated through activities such as averaging, it is advisable to verify the results remain positive definite. As discussed above, occasional numerical issues may be of concern in some instances. If required, force the SDM computed in Step 6 to be positive definite.

This is done by systematically reducing the magnitude of the cross spectral density terms until the Cholesky decomposition is possible at each depth (spectral line) of the SDM. (If required, this process may be somewhat conservative in its reduction of the coherence between DOFs in that the systematic reduction of cross term magnitudes is applied to each cross term equally).

Step 8 Scale the diagonal terms of the autospectra (the diagonal terms of the SDM) resulting from Step 7 to the maximum rms level of each of the N SDM's in Step 5 on an individual DOF basis using Miner-Palmgren.

MIL-STD-810H
METHOD 527.2 ANNEX E

Observe that a new total test time will be computed for each DOF and that it is highly probably that the resulting test times for each DOF will not be the same.

Since the magnitude of the autospectra are being increased while not modifying the cross-spectral density terms, the resulting scaled SDM should still be positive definite. However, as discussed in Step 7, it is highly recommended that anytime a SDM is manipulated, it should be verified that the resulting SDM remains positive definite.

- Step 9 Review the test time associated with each DOF resulting from Step 8 and select a reasonable test time to which the entire SDM may be referenced to. In this step, avoid scaling the dominant DOF by more than the maximum envelope of measured values for that DOF.

Just as in the case of a 1-DOF VSD development, one should consider the general guidance to keep the final test amplitudes resulting from time compression to be no more than 3 dB above the maximum measured field data. Once a test time is selected, reapply Miner-Palmgren as required per DOF. Again make sure the resulting SDM is positive definite and modify as required per Step 7.

- Step 10 Scale the results from Step 9 up by up to 3 dB, while not exceeding 3dB above the envelope of measured values per DOF, to account for uncontrolled variables such as fleet variations and scenario conditions not considered in the mission scenario. There are often practical limitations in maintaining all DOF's within 3 dB of the envelope of measured values from their respective DOF. In such cases, attempt to associate the maximum compression with the lowest level DOF or a DOF known to be mechanically robust. The resulting SDM and the test time association per Step 9 define the final specification.

This is accomplished by pre and post multiplying the SDM by the square root of the ratio of the desired scaling factor as:

$$\mathbf{S}_{Y_{\text{new}}} = \mathbf{S}_s \mathbf{S}_{Y_{\text{old}}} \mathbf{S}_s \quad (\text{e.g. to scale the SDM ASD terms by 3 dB while keeping the phase and ordinary coherence the same, the diagonal terms of } \mathbf{S}_s \text{ would be defined as } S_{s,ii} = \sqrt{2}).$$

[In the event the user has documented evidence that the mission scenario is of sufficient fidelity to minimize uncontrolled variables, the default scale factor of 3 dB in this step may be reduced].

6.1.2 Method II.

The following is a 10 step outline of Method II (Cholesky Domain) MDOF VSD:

Step 1-4 Correlate directly to Method I Outline.

- Step 5 Perform a Cholesky decomposition on the individual SDM associated with each Run in the mission scenario.

Since each individual Run was based on a physical event, the individual SDM's should be positive definite, thereby making the Cholesky decomposition possible. (Recall all Runs would have been tested to verify each was positive definite or corrected as required per Step 3).

Either organize all of the lower triangular matrices resulting from the Cholesky decomposition for the Runs of interest into a logical structure or merge them into one file of known matrix structure such as [CHOL_Run1,CHOL_Run2...CHOL_RunN] to optimize the conduct basic statistics.

- Step 6 Compute a weighted average Lower Triangular Matrix of the N Cholesky decompositions of Step 5.

The weighting factor on the average will be directly correlated to the mission scenario identified in Step 1. Note that the resulting average will still consist of positive eigenvalues implying that when converted back into the SDM format that the result will be positive definite.

Once converted back into the SDM domain, the resulting CSD terms will generally be highly comparable to the average CSD values computed in Step 6 of Method I. However, the rms levels

MIL-STD-810H
METHOD 527.2 ANNEX E

of the ASD terms will not be the same. In addition, the spectral shape of the ASD terms will generally have been slightly modified.

- Step 7 Rescale the ASD terms of the SDM resulting from Step 6 to match the rms levels of those in Method I Step 6.

Convert the CSD terms (the off-diagonal terms of the SDM) into a normalized form in which the magnitude squared of the cross terms correlates to the ordinary coherence while leaving the phase unchanged. (Again, while it is not absolutely necessary to conduct this step, it is often easier to understand the physical meaning of the CSD terms when viewed in terms of phase and coherence).

Observe that Method II involves the averaging of matrix square roots. The resulting SDM phase and coherence are expected to be very similar to those of the averaged field data produced in Method I. The ASD terms spectral shapes are expected to be slightly different (i.e. < 3 dB per spectral line for SDM's of similar statistical variance). The actual differences depend to a great deal on the statistical variation of the component square roots. If the statistical variation is significant, one may consider developing multiple references by grouping runs with similar spectral shapes or by reverting to Method I.

- Step 8-10 Correlate directly to Method I Outline.

6.2 Example.

- a. To illustrate the process discussed above, a simple example was derived (Method I is addressed first). Using an available wheeled vehicle, the input to an onboard missile storage rack was instrumented as shown in Figure 4. The transducer at the center of Figure 4 was placed at the user defined origin, position [0,0,0], in terms of a Cartesian coordinate system. In a traditional right hand orientation, the forward direction of the vehicle was defined as the positive x-axis, towards the vehicle driver's side was considered positive y-axis, and through the vehicle roof was considered the positive z-axis. All transducers are referenced in terms of their relative placement to the origin as discussed previously in the acceleration transformation section of this Annex.



Figure 4. Transducer placement (input to missile rack).

- b. Method I Example.
 - (1) Having established a clear coordinate system definition, the key parameters discussed in Step 1 are identified. In distance units of inches, the positions of the four corner accelerometer locations used in this example are defined as:

MIL-STD-810H
METHOD 527.2 ANNEX E

$r1=[-17,-6,0]'$, $r2=[-17,6,0]'$, $r3=[17,-6,0]'$, $r4=[17,6,0]'$, which in skew symmetric form are:

$$\begin{bmatrix} {}^P r_1^P \\ {}^P r_2^P \\ {}^P r_3^P \\ {}^P r_4^P \end{bmatrix}^x = \begin{bmatrix} 0 & 0 & -6 \\ 0 & 0 & 17 \\ 6 & -17 & 0 \end{bmatrix}, \begin{bmatrix} {}^P r_2^P \\ {}^P r_3^P \\ {}^P r_4^P \end{bmatrix}^x = \begin{bmatrix} 0 & 0 & 6 \\ 0 & 0 & 17 \\ -6 & -17 & 0 \end{bmatrix}, \begin{bmatrix} {}^P r_3^P \\ {}^P r_4^P \end{bmatrix}^x = \begin{bmatrix} 0 & 0 & -6 \\ 0 & 0 & -17 \\ 6 & 17 & 0 \end{bmatrix}, \begin{bmatrix} {}^P r_4^P \end{bmatrix}^x = \begin{bmatrix} 0 & 0 & 6 \\ 0 & 0 & -17 \\ -6 & 17 & 0 \end{bmatrix}$$

For convenience, the instrumentation team placed the tri-axial transducers such that the channel used to measure the y-axis motion was actually 180 degrees out of phase with respect to the referenced coordinate system. This issue is addressed by simply defining row selection vectors as $e_x^T = [1,0,0]$, $e_y^T = [0,-1,0]$, $e_z^T = [0,0,1]$. Matrix \bar{T}_a and matrix T_a may now be computed as per the discussion in paragraph 4.4.1.1 as:

$$\bar{T}_a = \begin{bmatrix} 1 & 0 & 0 & 0 & 0 & 6 \\ 0 & -1 & 0 & 0 & 0 & 17 \\ 0 & 0 & 1 & -6 & 17 & 0 \\ 1 & 0 & 0 & 0 & 0 & -6 \\ 0 & -1 & 0 & 0 & 0 & 17 \\ 0 & 0 & 1 & 6 & 17 & 0 \\ 1 & 0 & 0 & 0 & 0 & 6 \\ 0 & -1 & 0 & 0 & 0 & -17 \\ 0 & 0 & 1 & -6 & -17 & 0 \\ 1 & 0 & 0 & 0 & 0 & -6 \\ 0 & -1 & 0 & 0 & 0 & -17 \\ 0 & 0 & 1 & 6 & -17 & 0 \end{bmatrix}$$

$$T_a = \begin{bmatrix} 0.2500 & 0 & 0 & 0.2500 & 0 & 0 & 0.2500 & 0 & 0 & 0.2500 & 0 & 0 \\ 0 & -0.2500 & 0 & 0 & -0.2500 & 0 & 0 & -0.2500 & 0 & 0 & -0.2500 & 0 \\ 0 & 0 & 0.2500 & 0 & 0 & 0.2500 & 0 & 0 & 0.2500 & 0 & 0 & 0.2500 \\ 0 & 0 & -0.0417 & 0 & 0 & 0.0417 & 0 & 0 & -0.0417 & 0 & 0 & 0.0417 \\ 0 & 0 & 0.0147 & 0 & 0 & 0.0147 & 0 & 0 & -0.0147 & 0 & 0 & -0.0147 \\ 0.0046 & 0.0131 & 0 & -0.0046 & 0.0131 & 0 & 0.0046 & -0.0131 & 0 & -0.0046 & -0.0131 & 0 \end{bmatrix}$$

The field data were sampled at 4096 Hz and the bandwidth of interest is 500 Hz. For the example at hand, a mission scenario was established using a Beta distribution as discussed in reference number 3, and is illustrated in Table 1. Allowing for the time associated with speeds below 5 miles per hour (mph), the total mileage represented is approximately 300.

- (2) The field data were then converted into motion DOFs, $\{\mathbf{c}\}_{\text{Motion}}$, using Equation 4.3 per Step 2.
- (3) The time histories, $\{\mathbf{c}\}_{\text{Motion}}$ were then transformed into the frequency domain in the form of a SDM per run as described in Step 3. Each SDM was tested per the Cholesky decomposition property and verified to be positive definite.
- (4) Each SDM was then normalized as suggested in Step 4 to allow the analyst to review the degree of coherence between DOFs.

MIL-STD-810H
METHOD 527.2 ANNEX E

Table 1. Mission scenario.

Road Classification	Speed (mph)	Time (hrs)	Distance (miles)
Embedded Rock	5	.690	3.45
	10	1.545	15.45
	15	.737	11.05
Cross Country	10	5.18	51.80
	20	6.332	126.64
	30	2.002	60.06
Radial Washboard	5	.811	4.055
	7	1.841	12.88
	10	1.183	11.83

- (5) Per Step 5, the SDMs were configured into a convenient structure to allow statistical analysis. The data were configured as $SDM_all=[SDM_Run1,SDM_Run2\dots SDM_Run8]$. Observe only 8 of the 9 runs identified in the scenario are being considered. In reviewing the field data, the 5 mph radial washboard data were significantly lower than the rest of the Runs, determined to have no effect on fatigue, and were not considered in computing the basic statistics of the ensemble.
- (6) Next, per Step 6, a weighted average in terms of the time per road condition as defined in Table 1 was computed. This average should be computed in terms of complex CSD terms, not the normalized SDM. The resulting weighted average SDM was then tested at each spectral line to establish whether or not the positive definite criterion was met. Figure 5 illustrates the weighted average SDM. Taking advantage of the Hermitian property of a SDM, Figure 5 is laid out such that the lower triangular section represents the phase between DOFs, the upper triangular portion represents the square root of the ordinary coherence, and the diagonal terms are the ASDs of the 6 rigid body DOFs. Although too small to review in detail on a single page as shown, the coherence plots are all scaled between 0.1 and 1.0. This is to illustrate there is some level of coherence, particularly below 100 Hz in the example at hand, between DOFs. Using the VSD process proposed, the analyst will try to keep as much coherence in the final specification as possible while still ensuring the final result is positive definite.
- (7) In order to address the possibility of having to deal with non-positive definite results, a utility was written which gradually and equally reduces the magnitudes of the cross spectral density terms until the positive definite criterion is met per Step 7. This technique actually reduces the cross term magnitudes of some CSDs more than what is required. Addressing this potential shortcoming is one of the motivations for the development of Method II.
- (8) At this point, per Step 8, the rms level was computed for each ASD (diagonal SDM Entry) over the bandwidth of interest (3-500 Hz in this example). Each ASD was then scaled to the level of the maximum rms level via Equation 4.6.

MIL-STD-810H
METHOD 527.2 ANNEX E

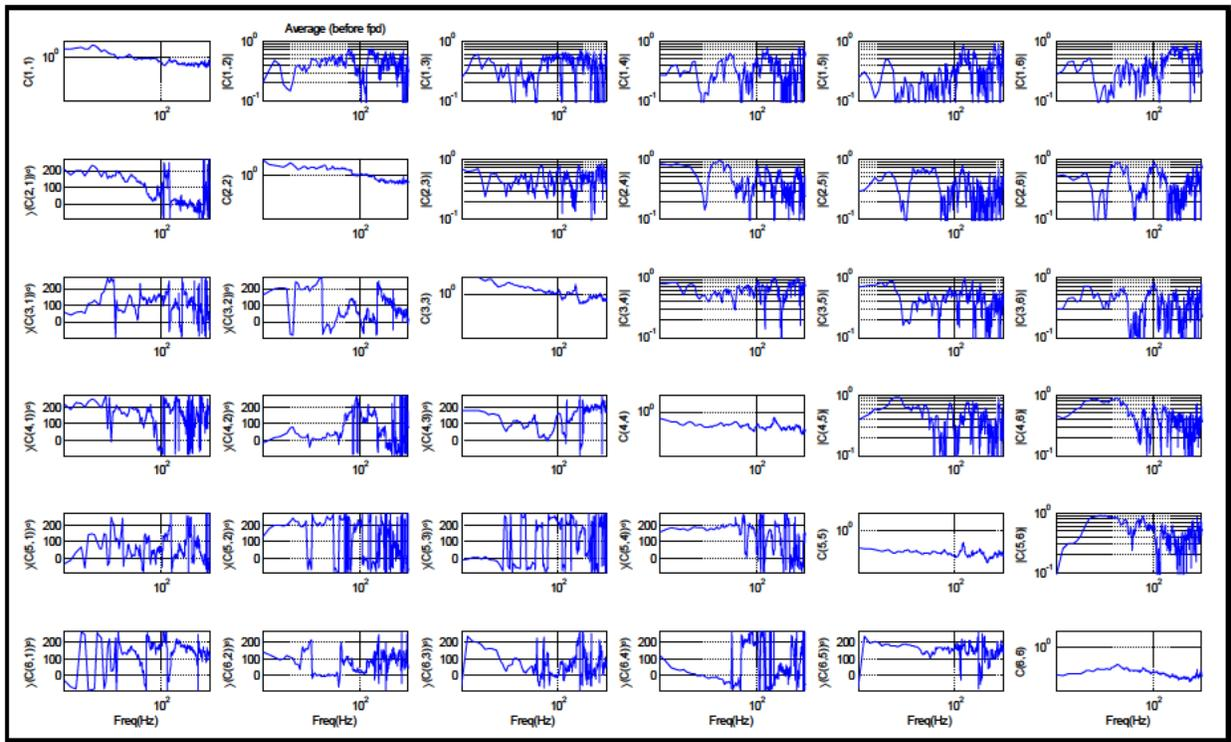


Figure 5. Normalized weighted average SDM.

- (9) Per Step 9, the new test times associated with each ASD were also documented. As expected, the new times associated with each DOF were no longer the same. Since the VSD effort is designed to yield a simultaneous 6-DOF reference, it will be necessary to choose a common test time and rescale all ASD entries to the selected test duration. For the example at hand, a test duration of 15 minutes was selected. As is always the case with selection of compressed test durations, one should adhere to the guidance of not exaggerating the ASD power levels by more than 2:1. Of course when dealing with 6 ASD terms, this is not always possible. In such cases, the analyst should avoid increasing the dominant DOFs or DOFs with known structural shortcomings by more than 3 dB above maximum measured ASD levels.
- (10) The terms comprising the SDM were based on average ASD and CSD estimates, which is in contrast to the guidance provided in reference number 3, in which the ASD levels carried through the calculations of a 1-DOF VSD were actually based on an ASD computed as the sum of a Mean ASD and standard deviation computed on a per spectral line basis. Working directly with the mean ASD levels is intended to avoid excessive conservatism in the VSD process. Conservatism intended to address uncontrolled variables such as fleet variations and conditions not considered in the mission scenario are addressed by a single scalar (+3 dB in this example) in Step 10. Clearly the analyst has the ability to modify the final conservatism level based on knowledge of the specific VSD effort.

The final reference SDM produced by Method I is shown in Figure 6. Observe that the phase and coherence terms are essentially unchanged from that of the average SDM of Figure 5.

MIL-STD-810H
METHOD 527.2 ANNEX E

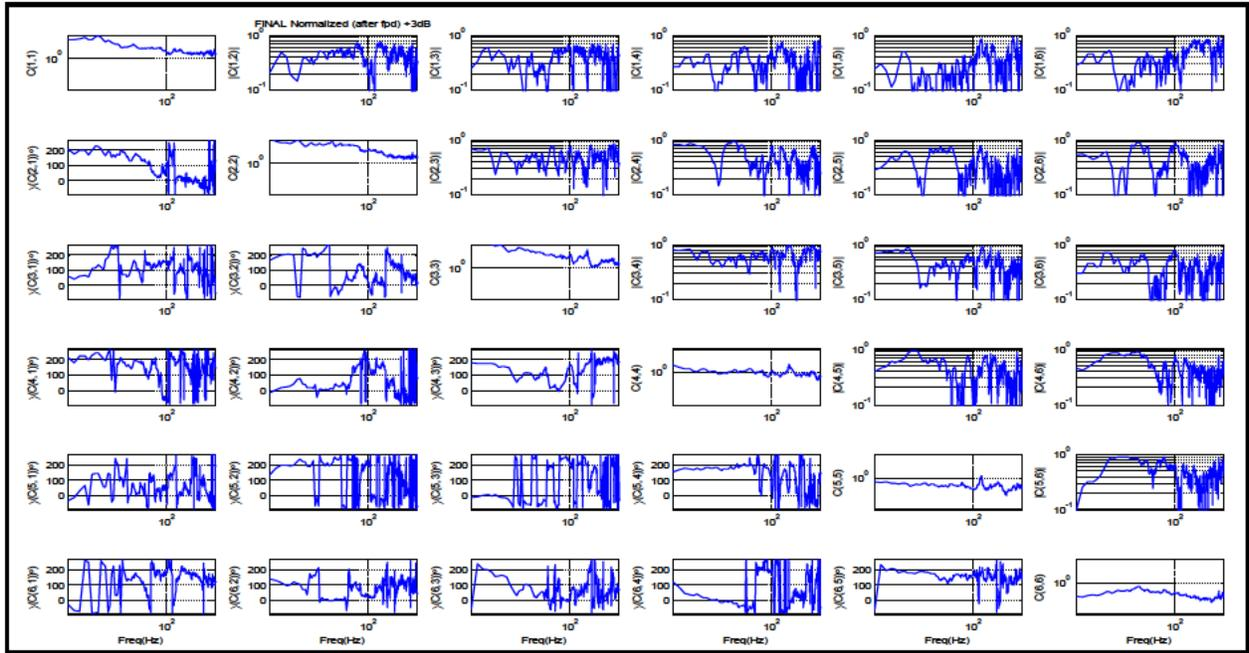


Figure 6. Method I normalized reference SDM.

- c. Method II Example. The first four steps of Method II correlate directly to that of Method I. The major deviation in Method II is that all averaging will be computed in the Cholesky domain. In Step 5, Cholesky decompositions are carried out on the individual SDM's associated with each Run in the mission scenario. Since each individual Run was based on a measured physical event, the individual SDMs were positive definite as expected, thereby making the Cholesky decomposition possible. In the event that a given Run had failed the Cholesky decomposition and all measurement locations and relative polarities were verified; investigate the spectral lines at which the decomposition fails. If the decomposition is failing at only a few spectral lines, it may be possible to salvage the measurement employing the CSD magnitude reduction techniques proposed in Method I. The Cholesky domain data were then organized into a convenient structure for statistical analysis. As in Method I, Matlab was used to compute the weighted averages and the Cholesky domain data were organized as: $CHOL_all=[CHOL_Run1, CHOL_Run2, \dots, CHOL_RunN]$. In Step 6, a weighted average in terms of the time per road condition as defined in Table 1 was computed over the lower triangular matrix of the eight Cholesky decompositions of Step 5. The weighted average was then converted back into the SDM domain. As expected, the coherence characteristics of the resulting SDM were comparable with that of Figure 5 and the rms levels of the ASD terms required rescaling per Step 7. Steps 8-10 were carried out directly as stated in the Method I outline.
- d. The reference SDM resulting from Method II (Figure 7) yielded similar phase and coherence characteristics to that of the reference SDM resulting from Method I (Figure 6). Note that the Method I example took advantage of averaging only the lower triangular CSD terms, avoiding potential numerical issues, thereby not requiring the SDM to be forced positive definite in a manner that would result in lowering the coherence in a more conservative manner than required.
- e. ASD Comparisons. Next, the minor spectral shape deviations between the ASD resulting from the two VSD methods discussed will be illustrated. Figures 8 and 9 show the ASD references for the Z axis (vertical) and rotation about Z axis (Rz) respectively, as produced from both VSD methods. The ASD references are superimposed with the raw (unexaggerated) reference data from which the specifications were created. Observe that the ASD shapes envelope the field data without excessive conservatism.

MIL-STD-810H
METHOD 527.2 ANNEX E

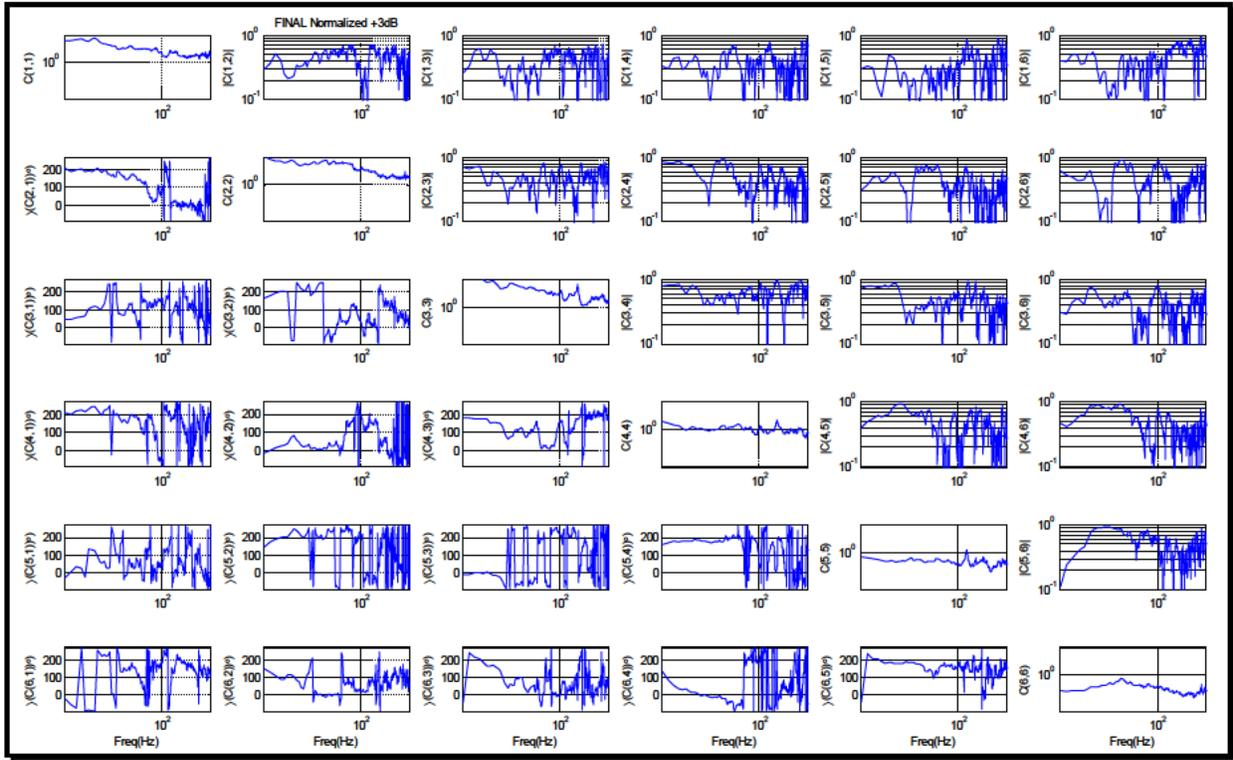


Figure 7. Method II reference SDM.

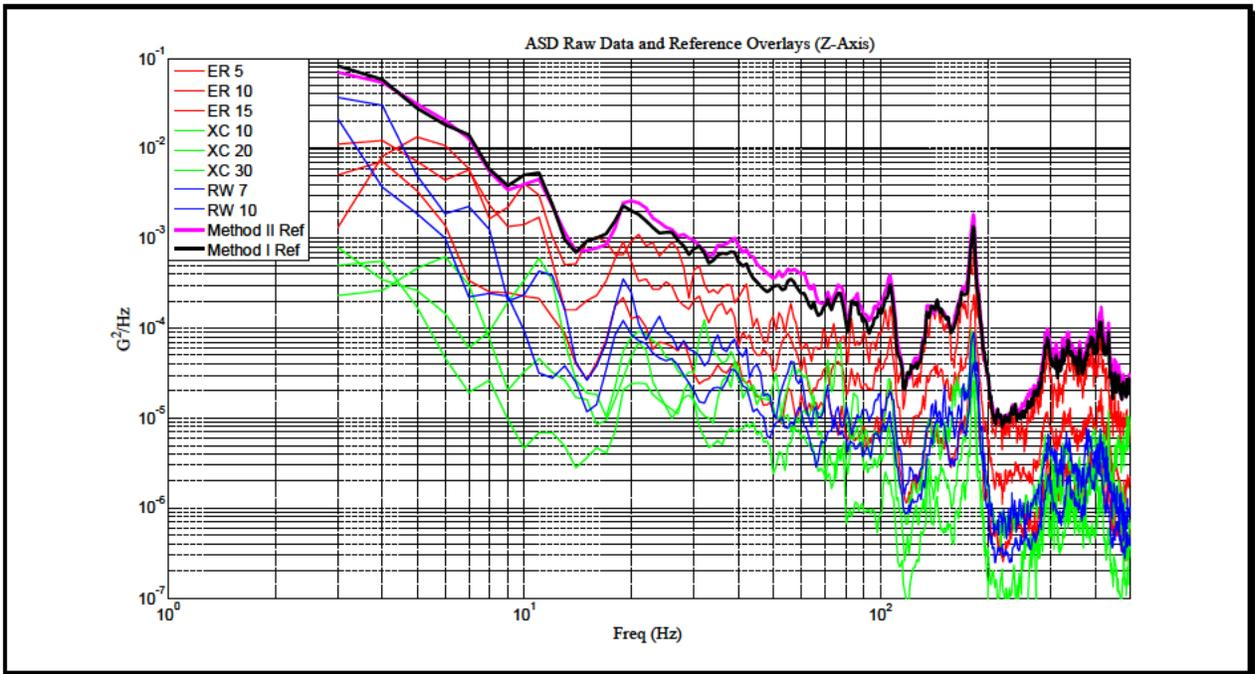


Figure 8. ASD references for the Z axis.

MIL-STD-810H
METHOD 527.2 ANNEX E

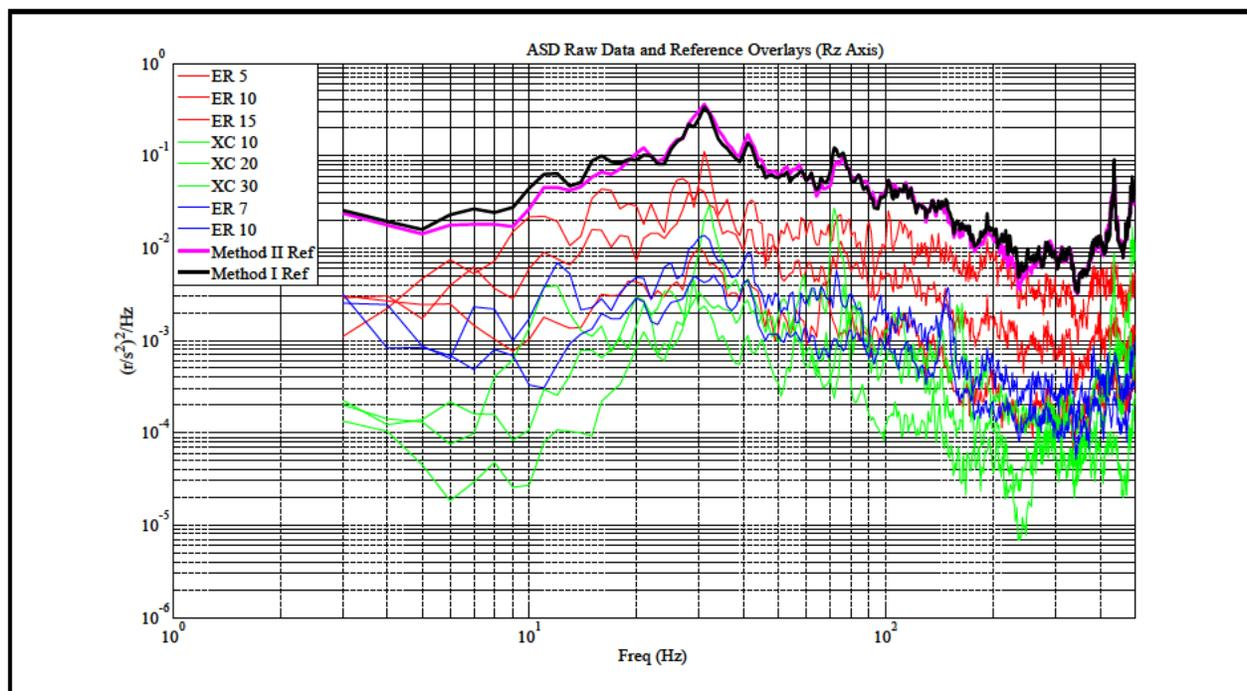


Figure 9. ASD references for rotation about Z axis (Rz).

- f. As stated previously, the test duration for the reference SDM yielded by both Methods in this example was established to be 15 minutes. Clearly, as illustrated in Figures 8 and 9 the associated ASD references are highly correlated.

6.3 Concluding Remarks.

- a. Two techniques were defined for establishing an input specification for a MDOF system. It was shown that simple enveloping techniques are not appropriate when considering CSD terms due to the sensitivity of such operations associated with maintaining a physically realizable reference. The resulting SDM references yielded through the process outlined are fully populated SDM's. Importing the fully populated SDM into the MDOF control system in an efficient manner is essential due to the volume of information involved.
- b. While synthesizing a drive signal with CSD characteristics of the field data is desired, it is recognized that the mechanical impedance of the laboratory configuration is highly unlikely to match that of the field data. Therefore, it will be difficult to maintain CSD characteristics across the spectral bandwidth of interest and thus, the control hierarchy will generally place emphasis on the ASD terms. Also, it is not uncommon in MDOF tests for a specific mechanical degree-of-freedom to consist of a very small percentage of the composite energy across all mechanical degrees-of-freedom. In such cases, the associated error for the low DOF will often be higher than the desired test tolerances and considering global test tolerances may need to be considered.
- c. Care was taken in the examples provided to limit the amount of conservatism in the VSD process. One quickly realizes that the amount of conservatism is cumulative across degrees of freedom and if not managed carefully will yield test levels significantly higher than the measured environment. Unlike, the common technique of essentially adding 3 dB to all measurements prior to conducting averaging or enveloping techniques in the 1-DOF arena per reference number 3, all weighted averages in the 6-DOF examples shown were based on raw averaged data. Conservatism to account for variables such as fleet variability and mission scenario omissions were added in the final step. Magnitude amplification associated with time compression techniques was limited to no more than maximum measured levels. Also, on the subject of tolerances, one may find it reasonable to define phase and coherence tolerances over only a portion of the test bandwidth. In the example provided, the coherence dropped off considerably at frequencies above 50 Hz. Since the phase

MIL-STD-810H
METHOD 527.2 ANNEX E

term is essentially a random variable for low coherence, setting tolerances for frequencies greater than 50 Hz would not be recommended for the example shown.

MIL-STD-810H
METHOD 527.2 ANNEX E, APPENDIX A

METHOD 527.2, ANNEX E, APPENDIX A

GLOSSARY

Refer to paragraph 1.2.2 of this Method. Additional terms specific to this Appendix follow:

- a. **Laboratory Vibration Test Schedule (LVTS)** – All information required to perform a vibration test on a vibration exciter. Information typically includes: a broadband spectra (or profile), sine or narrowband information (if used), test run time, control accelerometer locations, control methods and tolerances, and any test specific information required.
- b. **Scenario** – A tabulation of expected exposure events and the corresponding durations.

MIL-STD-810H
METHOD 527.2 ANNEX E, APPENDIX A

(This page is intentionally blank.)

MIL-STD-810H
METHOD 527.2 ANNEX E, APPENDIX B**METHOD 527.2, ANNEX E, APPENDIX B**
ABBREVIATIONS

AECTP	Allied Environmental Conditions Test Publication
ASD	auto spectral density (also referred to as the power spectral density (PSD))
CG	center of gravity
CSD	cross spectral density
dB	decibel
DFT	discrete Fourier transform
DOF	degree of freedom
DTC	US Army Developmental Test Command
FRF	frequency response function
g/V	gravitational units/volts of drive
Hz	hertz
I/O	input/output
IEEE	Institute of Electrical and Electronics Engineers
IES	Institute of Environmental Sciences
IEST	Institute of Environmental Sciences and Technology
LCEP	Life Cycle Environment Profile
LOA	line of action
LVTS	Laboratory Vibration Test Schedule
MA	multi-axis
MDOF	multiple degree-of-freedom
MEMA	multiple-exciter multiple-axis
MESA	multiple-exciter single-axis
MET	multiple exciter test
MIL-STD	Military Standard
MIMO	multiple-input multiple-output
MISO	multiple-input single-output

MIL-STD-810H
METHOD 527.2 ANNEX E, APPENDIX B

NATO	North Atlantic Treaty Organization
NBROR	narrowband random on random
pinv	Moore Penrose pseudo inverse
PSD	power spectral density
rms	root mean square
RTC	US Army Redstone Test Center
SA	single-axis
SDM	spectral density matrix
SDOF	single degree-of-freedom
SESA	single-exciter/single-axis
SIMO	single-input multiple-output
SISO	single-input single-output
SOR	sine-on-random
TWR	Time Waveform Replication
UUT	unit under test
VSD	Vibration Schedule Development

MIL-STD-810H
METHOD 527.2 ANNEX E, APPENDIX C

METHOD 527.2, ANNEX E, APPENDIX C

NOMENCLATURE

Term	Definition
{ }	A vector where each element is a discrete time history or function of frequency, the discrete Fourier transform (DFT) of a time history. In general lower case letters will be used for functions of time and upper case letters will be used for functions of frequency. Sometimes lower case letters are used to designate an element in a matrix.
[]	Will denote a matrix. Usually a third dimension will denote time samples or samples as a function of frequency.
[] ^T	The transpose of a matrix.
[]'	The transpose of a real matrix or often used as a compact notation to represent the complex conjugate transpose of a matrix.
[] [*]	The complex conjugate transpose of a matrix (also see []' above).
[] [†]	The Moore Penrose pseudo inverse of a matrix.
^	Over a variable will denote an estimated value.
{a}	The vector of return acceleration signals.
A	The spectral density matrix of the return signals, typically in units of G^2/Hz .
{c}	A vector of the control signals from a MIMO system. Each element in the vector is a function of time. It can be thought of as a 2 dimensional matrix. First dimension is the input number. The second dimension is the time index.
{C}	The DFT of {c}.
C	The spectral density matrix of the control signals. The diagonal elements are the real auto-spectral densities of the control signals. The off diagonal elements are complex functions of frequency giving the cross spectral density between pairs of control signals.
{d}	A vector of drive signals into a MIMO system. Each element in the vector is a function of time. It can be thought of as a 2 dimensional matrix. First dimension is the input number. The second dimension is the time index.
[D]	The drive signals in the frequency domain. {d} is formed from [D] using a method called time domain randomization. Initially $\mathbf{D} = \mathbf{ZRZ}'$.

MIL-STD-810H
METHOD 527.2 ANNEX E, APPENDIX C

Term	Definition
E []	The expected value.
g	The acceleration of gravity.
[H]	A matrix of frequency response functions (FRF's) relating the control system response to the drive signals. Typically the elements will have units of g/V. Each element is a frequency response function. A third dimension typically is the amplitude as a function of a set of frequencies relating to the DFT of the input and response signals.
N_s	The number of drive signals, the number of shakers.
N_c	The number of control signals.
N_a	The number of acceleration return signals.
N_d	The number of output control variables.
R	The reference control spectral density matrix; the desired spectral density matrix.
{s}	The vector of shaker drive voltages.
S	The spectral density matrix of the drives in shaker space.
S_{CD}	The spectral density matrix between the control signal and the drives to the shakers.
T_a	The acceleration to control space transformation matrix.
T_s	The drive in the control space to voltages {s} to the shakers transformation matrix.
Z= H[†]	The system impedance matrix, typically units of volts/g.

MIL-STD-810H
METHOD 527.2 ANNEX E, APPENDIX D

METHOD 527.2, ANNEX E, APPENDIX D

MATRIX ALGEBRA REVIEW

A matrix is an array of numbers arranged in rows and columns. The size of the matrix is typically stated as $[n,m]$ or $n \times m$, where n is the number of rows and m is the number of columns. In this document 3 dimensional matrices are also used where the third dimension is typically samples in either the time or frequency domain. This Appendix will discuss only two dimensional matrices. It is assumed that if the matrix has 3 dimensions, that the operations can be performed on each 2 dimensional matrix along the third dimension. For example if the matrix is a matrix of frequency response functions, matrix operations will be performed at each frequency line. The definitions provided in this appendix are based on information provided primarily in reference numbers 12 and 13.

- a. SDM: A spectral density matrix is a 3 dimensional matrix. At each frequency line (the 3rd index) the matrix is a square complex matrix. Each diagonal element is the autospectrum of the corresponding element. Loosely an element in the SDM is defined as:

$$G_{ji}(k) = 2 \lim_{T \rightarrow \infty} \frac{1}{T} E[X_j(k,T)X_i^*(k,T)]$$

where: $G_{ji}(k)$ is the cross spectral density between the j 'th and i 'th random processes.

$X_j(k,T)$ and $X_i(k,T)$ are the discrete Fourier transforms of the time histories, and k is the frequency index. If $i = j$, the spectrum is called the autospectrum or the power spectrum. In reality, the true spectral density is generally not known and an estimate is employed. Some authors define the elements as:

$$G_{ij}(k) = 2 \lim_{T \rightarrow \infty} \frac{1}{T} E[X_x^*(k,T)X_j(k,T)]$$

The SDM matrix is Hermitian positive definite.

- b. Hermitian Matrix: A matrix, A , is Hermitian if the diagonal elements are real positive numbers and the corresponding off diagonal elements are complex conjugate pairs:

$$a_{ii} = \text{positive real number}$$

$$a_{ji} = a_{ij}^* = \text{conj}(a_{ij})$$

where: a_{ji} is the element form j 'th row, i 'th column of A .

Note: All valid spectral density matrices (SDM) are Hermitian.

- c. Positive Definite Matrix and Positive Semi-Definite Matrix: If a square Hermitian matrix, A , has all positive eigenvalues, the matrix is positive definite. If the matrix has zero eigenvalues the matrix is positive semi-definite. A Cholesky decomposition is possible for all positive definite matrices.

$$\mathbf{A} = \mathbf{L}\mathbf{L}'$$

where: \mathbf{L} is a lower triangular matrix with real positive values on the diagonal. \mathbf{L}' is the complex conjugate transpose of \mathbf{L} . If the matrix, \mathbf{A} , is positive semi-definite, special care must be taken in computing \mathbf{L} . If a zero element is found on the diagonal of \mathbf{L} , the entire column must be set to zero. Computing the Cholesky decomposition is actually the easiest way to check for positive definite. If the algorithm fails the matrix, \mathbf{A} is not positive definite.

- d. Transformation of a Positive Definite Matrix:

$$\text{Let } \mathbf{B} = \mathbf{H}\mathbf{A}\mathbf{H}'$$

If the matrix A is positive definite, B is positive definite.

Note: All valid SDMs are positive semi-definite or positive definite. Because some noise is always present in measured data, a measured SDM will always be positive definite.

MIL-STD-810H
METHOD 527.2 ANNEX E, APPENDIX D

- e. Ordinary Coherence, γ^2 : The ordinary coherence between two signals is defined as:

$$\gamma_{12}^2 = \frac{|G_{12}|^2}{G_{11}G_{22}}$$

G_{12} is the cross spectral density between the signals and G_{11} and G_{22} are the two autospectra.

The ordinary coherence is bounded by $0 \leq \gamma_{12}^2 \leq 1$.

Coherence is a measure of the linear relationship between the signals. If the coherence is unity, a perfect linear relationship exists between the signals. If the coherence is zero, the signals are said to be independent, and there is no linear relationship between the signals.

If one or more of the ordinary coherences in a SDM are in unity at any frequency, the matrix is positive semi-definite at that frequency.

- f. Singular Value Decomposition: Singular value decomposition has several applications in MIMO testing. Singular value decomposition is defined as:

$$\mathbf{M} = \mathbf{U}\mathbf{S}\mathbf{V}'$$

\mathbf{M} is any matrix. \mathbf{U} and \mathbf{V}' are orthonormal. This implies that:

$$\mathbf{U}\mathbf{U}' = \mathbf{I} \text{ and } \mathbf{V}\mathbf{V}' = \mathbf{I}$$

\mathbf{S} is a diagonal matrix of non-negative real numbers. A common convention is to order the diagonal elements of \mathbf{S} in a non-increasing fashion.

- g. Pseudo inverse: The Moore Penrose pseudo inverse is used often in MIMO control. Some of the properties are discussed below. The Moore Penrose pseudo inverse can be derived as follows:

$$\mathbf{M} = \mathbf{U}\mathbf{S}\mathbf{V}'$$

$$\mathbf{U}'\mathbf{M} = \mathbf{U}'\mathbf{U}\mathbf{S}\mathbf{V}' = \mathbf{S}\mathbf{V}'$$

$$\mathbf{S}^{-1}\mathbf{U}'\mathbf{M} = \mathbf{S}^{-1}\mathbf{S}\mathbf{V}' = \mathbf{V}'$$

$$\mathbf{V}\mathbf{S}^{-1}\mathbf{U}'\mathbf{M} = \mathbf{V}\mathbf{V}' = \mathbf{I}$$

$$\mathbf{M}^\dagger = \mathbf{V}\mathbf{S}^{-1}\mathbf{U}' \text{ is known as the pseudo inverse of } \mathbf{M}.$$

The inverse of the reduced \mathbf{S} is easy since the matrix is diagonal. To compute \mathbf{S}^{-1} the elements greater than a tolerance are inverted and kept, the elements less than a tolerance are replaced by zero.

$$\mathbf{M}\mathbf{M}^\dagger = \mathbf{M} \text{ and } \mathbf{M}^\dagger\mathbf{M} = \mathbf{M}^\dagger$$

$$\mathbf{M}\mathbf{M}^\dagger \text{ and } \mathbf{M}^\dagger\mathbf{M} \text{ are Hermitian}$$

If the number of columns in \mathbf{M} exceed the number of rows and the rows are independent $\mathbf{M}\mathbf{M}^\dagger = \mathbf{I}$. If the number of rows in \mathbf{M} exceeds the number of columns and the columns are independent $\mathbf{M}^\dagger\mathbf{M} = \mathbf{I}$. For a more complete discussion see the help file for pinv in MATLAB.

- h. Matrix Rank: The rank of a matrix, \mathbf{M} , equals the number of non-zero singular values in \mathbf{M} . In numerical linear algebra, the singular values can be used to determine the effective rank of a matrix. Define a measure of singular values as the ratio of the singular values and the largest singular value. Let r be the number values greater than a threshold. Where the measure is less than the threshold, set the singular values to zero. The number of non-zero singular values in the resulting matrix is the effective rank of the matrix. The effective rank of the matrix is r . For a square matrix, if r is less than the number of rows and columns in the matrix, the matrix is said to be ill conditioned.

- i. Matrix Approximation: Let $\tilde{\mathbf{M}} = \mathbf{u}\mathbf{s}\mathbf{v}'$

MIL-STD-810H
METHOD 527.2 ANNEX E, APPENDIX D

where: \mathbf{s} = a diagonal matrix of the singular values greater than a threshold defined as the ratio of the singular values divided by the largest singular value. Let n = the number of kept singular values. \mathbf{s} has n rows and columns. \mathbf{u} is the first n columns of \mathbf{U} . \mathbf{v}^* is the first n rows of \mathbf{V}^* .

$$\tilde{\mathbf{M}} \text{ minimizes } \|\mathbf{S} - \mathbf{u}\mathbf{s}\mathbf{v}^*\|_F$$

Hence, $\tilde{\mathbf{M}}$ is a very useful approximation of \mathbf{M} .

- j. Frobenius Norm: The Frobenius Norm of matrix \mathbf{M} is defined as:

$$\|\mathbf{M}\|_f = \sqrt{\sum_{i=1}^m \sum_{j=1}^n |m_{ij}|^2} = \sqrt{\text{trace}(\mathbf{A}'\mathbf{A})} = \sqrt{\sum_{i=1}^{\min(m,n)} \sigma_i^2}$$

where: σ_i are the singular values of \mathbf{M} .

- k. Trace: The trace of a positive definite matrix is defined as the sum of the diagonal elements. An important property of the trace often of use is:

$$\text{trace}(\mathbf{AB}) = \text{trace}(\mathbf{BA})$$

- l. Rescaling the Autospectra: When generating a SDM it might sometimes be useful to rescale the autospectra and be assured that the result remains positive definite. This can be accomplished by pre and post multiplying by a diagonal matrix of scaling factors. The triple product will rescale the autospectra while keeping the coherence and phase between pairs of channels unchanged.

$$\mathbf{G}_{\text{new}} = \mathbf{S}\mathbf{G}_{\text{old}}\mathbf{S}'$$

where: \mathbf{G}_{new} is the new positive definite SDM, \mathbf{G}_{old} is the original positive definite SDM, and \mathbf{S} is a diagonal matrix of scaling factors. Each autospectra will be scaled by the corresponding element in \mathbf{S}^2 .

This is a convenient way to generate the normalized SDM (the diagonal elements are the autospectra and the magnitude squared of the off diagonal terms are the ordinary coherence and the phase is the phase of the cross spectra). The normalized form is computed by rescaling the SDM to unity autospectra by pre and post multiplying the SDM by a diagonal matrix whose terms are the inverse square root of the autospectra. The resulting unity autospectra are then replaced by the original autospectra.

The inverse is computed by replacing the diagonal autospectra by ones and then rescaling by pre and post multiplying by a diagonal matrix whose terms are the square root of the original autospectra.

- m. Kinematic Transformation (Frequency Domain): The time domain based kinematic transformation derived in paragraph 4.4.1 of this Annex yielded:

$$\begin{Bmatrix} \mathbf{a} \end{Bmatrix}_{\text{Meas}} = \begin{bmatrix} \bar{\mathbf{T}}_a \end{bmatrix} \begin{Bmatrix} \mathbf{c} \end{Bmatrix}_{\text{Motion}} \quad \text{and} \quad \begin{Bmatrix} \mathbf{c} \end{Bmatrix}_{\text{Motion}} = \begin{bmatrix} \mathbf{T}_a \end{bmatrix} \begin{Bmatrix} \mathbf{a} \end{Bmatrix}_{\text{Meas}}$$

$(n \times 1)$ $(n \times 6)$ (6×1) (6×1) $(6 \times n)$ $(n \times 1)$

Given the same rigid body constraint, the same input transformation matrix $\begin{bmatrix} \mathbf{T}_a \end{bmatrix}$ may be employed to transform a spectral density matrix between motion and measurement space as follows (Paragraph 6.1, reference q):

$$\begin{bmatrix} \text{SDM}_{\text{meas}} \end{bmatrix} = \begin{bmatrix} \bar{\mathbf{T}}_a \end{bmatrix} \begin{bmatrix} \text{SDM}_{\text{motion}} \end{bmatrix} \begin{bmatrix} \bar{\mathbf{T}}_a \end{bmatrix}' \quad \text{and} \quad \begin{bmatrix} \text{SDM}_{\text{motion}} \end{bmatrix} = \begin{bmatrix} \mathbf{T}_a \end{bmatrix} \begin{bmatrix} \text{SDM}_{\text{meas}} \end{bmatrix} \begin{bmatrix} \mathbf{T}_a \end{bmatrix}'$$

$(n \times n \times n)$ $(n \times 6)$ $(6 \times 6 \times 6)$ $(6 \times n)$ $(6 \times 6 \times 6)$ $(6 \times n)$ $(n \times n \times n)$ $(n \times 6)$

MIL-STD-810H
METHOD 527.2 ANNEX E, APPENDIX D

n. Proof 1:

An element in S_Y is given by, where n = number of inputs, and m = number of outputs

$$Y_{ij} = \sum_{r=1}^n \sum_{k=1}^n X_{rk} H_{ir} H_{jr}^* \quad i = 1:m \quad j = 1:m$$

A diagonal element is given by:

$$Y_{ii} = \sum_{r=1}^n \sum_{k=1}^n X_{rk} H_{ir} H_{ir}^* = \sum_{r=1}^n \sum_{k=1}^n X_{rk} |H_{ir}|^2 \quad i = 1:m$$

If S_x is diagonal, $X_{rk} = 0$, if $r \neq k$, then:

$$Y_{ii} = \sum_{r=1}^n X_{rr} |H_{ir}|^2 \quad i = 1:m$$

This can be written as a set of linear equations:

$$\bar{Y} = \bar{H}\bar{X}$$

Which can be solved for \bar{X} as: $\bar{X} = \bar{H}^{-1}\bar{Y}$

MIL-STD-810H
METHOD 527.2 ANNEX E, APPENDIX E**METHOD 527.2, ANNEX E, APPENDIX E****REFERENCES**

1. MIL-STD-810G, Department of Defense Test Method Standard: Environmental Engineering Considerations and Laboratory Tests, 31 October 2008.
2. Handbook for Dynamic Data Acquisition and Analysis, IEST-RP-DTE012.2, Institute of Environmental Sciences and Technology, Arlington Place One, 2340 S. Arlington Heights Road, Suite 100, Arlington Heights, IL 60005-4516.
3. AECTP 240, Edition 4, Leaflet 2410, Development of Laboratory Vibration Test Schedules, 1 June 2009.
4. Smallwood, D.O., "Multiple Shaker Random Control with Cross Coupling", Proceedings of the Institute of Environmental Sciences (IES), April 18-20 1978, pages 341-347.
5. Underwood, M., "Multi-Exciter Testing Applications: Theory and Practice"; Proceedings of the Environmental Sciences and Technology, ESTECH2002, May 1, 2002, Anaheim, CA.
6. US Army Developmental Test Command (DTC) / US Army Redstone Test Center (RTC) Methodology Study of MIMO Vibration Specification Guidance, March 2010.
7. Welch, P.D., "The Use of Fast Fourier Transform for the Estimation of Power Spectra: A Method Base on Time Averaging Over Short, Modified Periodograms", Institute of Electrical and Electronics Engineers (IEEE) Transactions on Audio and Electroacoustics, Volume AU-15, Number 2 / June 1967.
8. Draft Multi-Shaker Test and Control: Design, Test, and Evaluation Division Recommended Practice 022.1, IEST-RP-DTE022.1, April 2008.
9. Underwood, M. and Keller, T. "Applying Coordinate Transformations to Multi-DOF Shaker Control." Sound and Vibration Magazine, January 2006.
10. Fitz-Coy, N, Hale, M. and Nagabhushan, V., "Benefits and Challenges of Over-Actuated Excitation Systems", Shock and Vibration Journal, Volume 17, Number 3 / 2010.
11. Hale, M and Fitz-Coy, N., "On the Use of Linear Accelerometers in Six-DOF Laboratory Motion Replication: A Unified Time-Domain Analysis", 76th Shock and Vibration Symposium, 2005.
12. Golub and van Loan, Matrix Computations, John Hopkins Press, 3rd Edition, 1989.
13. Bendat, J. and Piersol, A. G., Random Data Analysis and Measurement Procedures, John Wiley and Sons, Inc, New York, 3rd Edition, 2000.
14. Smallwood, D.O., "Multiple-Input Multiple-Output (MIMO) Linear Systems Extreme Inputs/Outputs", Shock and Vibration Journal, Vol. 14, Number 2 / 2007, pages 107-132.
15. Smallwood, D.O., "A Proposed Method To Generate a Spectral Density Matrix for a Multiple Input, Multiple Output (MIMO) Vibration Test", 80th Shock and Vibration Symposium, 2010.
16. Wirsching, Paez, and Ortiz, Random Vibrations, Theory and Practice, Wiley 1995.
17. Hale, M., "A 6-DOF Vibration Specification Development Methodology", Journal of the IEST, V. 54, No. 2, 2011.
18. Hale, M., "Spectral Density Matrix Transformations", Journal of the IEST, V. 60, No. 1, pp 17-26, 2017.
19. Martin, L and Schneider, S, "On the Nature of Spectral Density Matrices used to Characterize Vibration Environments", Proceedings of the 87th Shock and Vibration Symposium, Oct 2016, pp 349-363.

MIL-STD-810H
METHOD 527.2 ANNEX E, APPENDIX E

(This page is intentionally blank.)

MIL-STD-810H
METHOD 528.1**METHOD 528.1****MECHANICAL VIBRATIONS OF SHIPBOARD EQUIPMENT
(TYPE 1 – ENVIRONMENTAL AND TYPE II – INTERNALLY EXCITED)****CONTENTS**

<u>Paragraph</u>	<u>Page</u>
1. SCOPE	1
1.1 PURPOSE	1
1.2 APPLICABILITY	1
1.3 CLASSIFICATION	1
1.4 LIMITATIONS.....	1
2. APPLICABLE DOCUMENTS AND DEFINITIONS	1
2.1 GENERAL	1
2.2 DEFINITIONS	1
3. INFORMATION REQUIRED.....	3
3.1 PRETEST.....	3
3.2 DURING TEST.....	4
3.3 POST-TEST	4
4. GENERAL REQUIREMENTS - TEST PROCESS.....	5
4.1 TEST FACILITY.....	5
4.2 CONTROLS	5
4.2.1 CONTROL STRATEGY	5
4.2.1.1 ACCELERATION INPUT CONTROL STRATEGY	5
4.2.1.2 FORCE CONTROL STRATEGY	5
4.2.1.3 ACCELERATION LIMIT STRATEGY	6
4.2.1.4 ACCELERATION RESPONSE CONTROL STRATEGY	6
4.2.1.5 WAVEFORM CONTROL STRATEGY	6
4.2.2 TOLERANCES.....	6
4.2.2.1 ACCELERATION SPECTRAL DENSITY.....	6
4.2.2.2 PEAK SINUSOIDAL ACCELERATION	7
4.2.2.3 FREQUENCY MEASUREMENT.....	7
4.2.2.4 CROSS AXIS SENSITIVITY.....	7
4.3 TEST INTERRUPTION	7
4.3.1 INTERRUPTION DUE TO LABORATORY EQUIPMENT MALFUNCTION	7
4.3.2 INTERRUPTION DUE TO TEST ITEM OPERATION FAILURE.....	7
4.3.3 INTERRUPTION DUE TO A SCHEDULED EVENT.....	8
4.3.4 INTERRUPTION DUE TO EXCEEDING TEST TOLERANCES	8
5. DETAILED REQUIREMENTS	8
5.1 PROCEDURE I (TYPE I) - ENVIRONMENTAL VIBRATION.....	8
5.1.1 BASIS OF ACCEPTABILITY	8
5.1.2 TEST PROCEDURES.....	9
5.1.2.1 TESTING MACHINE.....	9
5.1.2.2 ADDITIONAL TEST INSTRUMENTATION	9
5.1.2.3 METHODS OF ATTACHMENT.....	9
5.1.2.4 VIBRATION TESTS	10

MIL-STD-810H
METHOD 528.1

CONTENTS - Continued

<u>Paragraph</u>	<u>Page</u>
5.1.2.5 TEST DOCUMENTATION	13
5.1.3 EXEMPTION	13
5.1.4 EXTENSION OF PREVIOUS TESTING	13
5.1.4.1 EXTENSION DOCUMENTATION	14
5.1.5 ALIGNMENT CRITERIA	14
5.2 PROCEDURE II (TYPE II – INTERNALLY EXCITED VIBRATION)	14
5.2.1 BASIS OF ACCEPTABILITY	14
5.2.2 BALANCE PROCEDURE FOR RIGID ROTORS	15
5.2.2.1 BALANCING METHODS FOR RIGID ROTORS	15
5.2.2.2 BALANCE LIMITS FOR RIGID ROTORS	15
5.2.3 BALANCE PROCEDURE FOR FLEXIBLE ROTORS	16
5.2.3.1 BALANCE LIMITS FOR FLEXIBLE ROTORS	16
5.2.3.2 VIBRATION TEST PROCEDURE	16
5.3 ANALYSIS OF RESULTS	17
5.3.1 PHYSICS OF FAILURE	17
5.3.2 QUALIFICATION TESTS	17
5.3.3 OTHER TESTS	18
6. REFERENCE/RELATED DOCUMENTS	18
6.1 REFERENCED DOCUMENTS	18
6.2 RELATED DOCUMENTS	18

FIGURES

FIGURE 528.1-1. TYPE I ENVIRONMENTAL VIBRATION LIMITS (BLACK BARS REPRESENT A GRAPHICAL PRESENTATION OF TABLE 528.1-I EXPRESSED IN DISPLACEMENT, VELOCITY, AND ACCELERATION)	12
FIGURE 528.1-2. VIBRATION ACCEPTANCE CRITERIA FOR TYPE II VIBRATION	16
FIGURE 528.1-3. MINIMUM STATIC DEFLECTION OF MOUNTING FOR TYPE II VIBRATION TEST	17

TABLES

TABLE 528.1-I. VIBRATORY DISPLACEMENT OF ENVIRONMENTAL VIBRATION	11
TABLE 528.1-II. DURATION OF ENDURANCE TEST IN A GIVEN ORTHOGONAL DIRECTION AT EACH TEST FREQUENCY	12
TABLE 528.1-III. VIBRATORY DISPLACEMENT OF ENVIRONMENTAL VIBRATION FOR MAST MOUNTED EQUIPMENT	13
TABLE 528.1-IV. TYPES OF BALANCING	14

METHOD 528.1 ANNEX A

IDENTIFYING RESPONSE PROMINENCES TO BE INCLUDED IN ENDURANCE TESTING

1. SCOPE	A-1
2. PROCEDURE	A-1
2.1 DETERMINING AND DISPLAYING TRANSMISSIBILITY	A-1
2.1.1 TRANSMISSIBILITY MAGNITUDES	A-1
2.1.2 TRANSMISSIBILITY AND FREQUENCY	A-1
2.2 IDENTIFYING RESPONSE PROMINENCES	A-1
2.3 SELECTING ENDURANCE TEST FREQUENCIES	A-2
2.3.1 NON-RESPONSE PROMINENCE FREQUENCIES WHERE FUNCTIONAL OR STRUCTURAL INTEGRITY IS AFFECTED	A-2

MIL-STD-810H
METHOD 528.1

CONTENTS - Continued

<u>Paragraph</u>		<u>Page</u>
2.3.2	FREQUENCIES WHERE RESPONSE PROMINENCES HAVE BEEN IDENTIFIED.....	A-2
2.4	GUIDANCE FOR SPECIFIERS	A-3

**METHOD 528.1 ANNEX B
NOTES AND ENGINEERING GUIDANCE**

1.	INTENDED USE	B-1
2.	ACQUISITION REQUIREMENTS.....	B-1
3.	ASSOCIATED DATA ITEMS DESCRIPTIONS (DIDs).....	B-2
4.	TAILORING GUIDANCE FOR CONTRACTUAL APPLICATION.....	B-2
5.	SUPERSEDING DATA	B-2
6.	GUIDANCE DOCUMENTS	B-3

ANNEX B TABLE

TABLE 528.1B-I. RELATED DOCUMENTS	B-3
---	-----

MIL-STD-810H
METHOD 528.1

(This page is intentionally blank.)

MIL-STD-810H
METHOD 528.1

METHOD 528.1

MECHANICAL VIBRATIONS OF SHIPBOARD EQUIPMENT (TYPE I – ENVIRONMENTAL AND TYPE II – INTERNALLY EXCITED)

NOTE: This Method incorporates the requirements of MIL-STD-167-1A and additional lessons learned. This method shall be considered a requirement for US Navy vessels, and guidance for other applications.

1. SCOPE.

1.1 Purpose.

This Method specifies procedures and establishes requirements for environmental and internally excited vibration testing of Naval shipboard equipment installed on ships (see Annex B, paragraphs 1e and f).

1.2 Applicability.

The test procedures specified herein are applicable to shipboard equipment subjected to mechanical vibrations on Navy ships with conventional shafted propeller propulsion, and can be tailored according to Paragraph 5.1 for non-conventional propulsor types such as waterjet or podded propulsors. For internal excitation caused by unbalanced rotating components of Naval shipboard equipment, use the balance procedure according to paragraph 5.2.2. For those mechanical vibrations associated with reciprocating machinery and lateral and longitudinal vibrations of propulsion systems and shafting, see MIL-STD-167-2A.

1.3 Classification.

The following types of vibration are covered in this Method:

- a. Type I – Environmental Vibration.
- b. Type II – Internally Excited Vibration.

1.4 Limitations.

See paragraph 1.2 for limitations.

2. APPLICABLE DOCUMENTS AND DEFINITIONS.

2.1 General.

The documents listed in paragraph 6.1 are specified in paragraphs 3, 4, or 5 of this Method. This paragraph does not include documents cited in other paragraphs of this Method, or recommended for additional information, or as examples. While every effort has been made to ensure the completeness of this list, document users are cautioned that they must meet all specified requirements of documents cited in paragraphs 3, 4, or 5 of this Method, whether or not they are listed.

2.2 Definitions.

- a. **Acceptance authority.** As used in this Standard, the term “acceptance authority” means the government activity (or its designated representative) having approval authority to determine vendor compliance with the requirements of this Method.
- b. **Amplitude, single.** See amplitude, vibratory displacement.
- c. **Amplitude, vibratory displacement.** Vibratory displacement amplitude is the maximum displacement of simple linear harmonic motion from the position of rest. This is also referred to as single amplitude or peak amplitude and is the maximum positive value during a given interval. It is expressed in inches, mils (0.001 inch), or mm (0.001 meter).
- d. **Balancing.** Balancing is a procedure by which the radial mass distribution of a rotor is adjusted so that the mass centerline approaches the geometric centerline of the rotor, and, if necessary, adjusted in order to ensure

MIL-STD-810H
METHOD 528.1

that the vibration of the journals or forces on the bearings, at a frequency corresponding to operational speed, are within specified limits.

- e. **Balancing, multi-plane.** Multi-plane balancing refers to any balancing procedure that requires unbalance correction in more than two axially separated correction planes.
- f. **Balancing, single-plane (static).** Single-plane (static) balancing is a procedure by which the mass distribution of a rigid rotor is adjusted in order to ensure the residual static unbalance is within specified limits, and that requires correction in only one plane. (Note: Single-plane balancing can be done on a pair of knife edges without rotation of the rotor, but is now more usually done on centrifugal balancing machines.)
- g. **Balancing, two-plane (dynamic).** Two-plane (dynamic) balancing is a procedure by which the mass distribution of a rigid rotor is adjusted in order to ensure that the residual unbalance in two specified planes is within specified limits.
- h. **Critical speed.** Critical speed is the speed of a rotating system that corresponds to a natural frequency of the system.
- i. **Environmental vibration.** Environmental vibration is vibratory force that is imposed on equipment installed aboard ships under all external conditions. The hydrodynamic force from the propeller blades interacting with the hull is usually the principal exciting force.
- j. **Equipment.** Equipment is any rotating or non-rotating machine that is intended to be installed aboard ship.
- k. **Grade, balance quality.** Balance quality grade, G, refers to the amount of permissible unbalance of a rotor. The balance quality grade is the product of the maximum permissible eccentricity (distance between the shaft axis and the rotor center of gravity (in mm)) and the rotational velocity (radians/sec). The units for balance quality grade, G, are mm/sec. By this definition, a particular grade rotor will be allowed a mass eccentricity ($e=G/\omega$), that is inversely proportional to the operating speed.
- l. **Internally excited vibration.** Internally excited vibration is vibration of machinery generated by mass unbalance of a rotor.
- m. **Isolation mount.** An isolation mount is a device used to attenuate the force transmitted from the equipment to its foundation in a frequency range.
- n. **Mass unbalance.** Mass unbalance occurs when the mass centerline does not coincide with the geometric centerline of a rotor.
- o. **Maximum design rpm.** Maximum design rpm is the highest shaft rpm for which the ship is designed.
- p. **Method of correction.** A method of correction is a procedure, whereby the mass distribution of a rotor is adjusted to reduce unbalance or vibration due to unbalance, to an acceptable value. Corrections are usually made by adding materiel to, or removing it from, the rotor.
- q. **Mode.** Natural Mode is the manner or pattern of vibration at a natural frequency, and is described by its natural frequency and relative amplitude curve.
- r. **Plane, correction.** A correction plane is a plane transverse to the shaft axis of a rotor in which correction for unbalance is made.
- s. **Plane, measuring.** A measuring plane is a plane transverse to the shaft axis in which the amount and angle of unbalance is determined.
- t. **Residual unbalance.** Residual unbalance is unbalance of any kind that remains after balancing.
- u. **Resonance.** Resonance is the structural response that occurs when a linear lightly damped system is driven with a sinusoidal input at its natural frequency in which the response prominence is greater than one.
- v. **Response prominence.** Response prominence is a general term denoting a resonance or other distinct maximum, regardless of magnitude, in a transmissibility function, including local maxima that may exist at the frequency endpoints of the transmissibility function. Typically, a response prominence is identified by the frequency of its maximum response that is the response prominence frequency. A response prominence of a system in forced oscillation exists when any change, for both plus and minus increments however small,

MIL-STD-810H
METHOD 528.1

in the frequency of excitation results in a decrease of the system response at the observing sensor registering the maximum. A response prominence may occur in an internal part of the equipment, with little or no outward manifestation at the vibration measurement point, and in some cases, the response may be detected by observing some other type of output function of the equipment, such as voltage, current, or any other measurable physical parameter. Instruction on how to identify response prominences is provided in Annex A.

- w. **Rotor, flexible.** A flexible rotor is one that does not meet the criteria for a rigid rotor and operates above its first resonance. The unbalance of a flexible rotor changes with speed. Any value of unbalance assigned to a flexible rotor must be at a particular speed. The balancing of flexible rotors requires correction in more than two planes. A rotor that operates above n resonances requires $n+2$ balance planes of correction. A rotor that operates between the second and third resonances, for example, requires 2+2 balance planes of correction.
- x. **Rotor, rigid.** A rotor is considered to be rigid when its unbalance can be corrected in any two arbitrarily selected planes and it operates below its first resonance. After correction, its residual unbalance does not exceed the allowed tolerance, relative to the shaft axis, at any speed up to the maximum service speed and when running under conditions that approximate closely to those of the final supporting system.
- y. **Simple harmonic motion.** A simple harmonic motion is a motion such that the displacement is a sinusoidal function of time.
- z. **Test fixture resonance.** A test fixture resonance is any enhancement of the response of the test fixture to a periodic driving force when the driving frequency is equal to a natural frequency of the test fixture.
- aa. **Transmissibility.** Transmissibility is the non-dimensional ratio of the response amplitude in steady-state forced vibration to the excitation amplitude. The ratio may be one of forces, displacements, velocities, or accelerations. Transmissibility is displayed in a linear-linear plot of transmissibility as a function of frequency, or in tabular form. Instructions for determining and displaying transmissibility are given in paragraph 2.1 of Annex A.
- bb. **Vibration resistance.** It is measured by mechanical impedance – how hard it is to make mechanical systems vibrate. It is a ratio of the exciting force to the velocity response. Low impedance implies low force and/or high velocity—a system that is easy to excite.

3. INFORMATION REQUIRED.

The following information is required to conduct and document vibration tests adequately. Tailor the lists to the specific circumstances, adding or deleting items as necessary. Although generally not required in the past, perform fixture and equipment modal surveys when practical. These data are useful in evaluating test results, and in evaluating the suitability of equipment against changing requirements or for new applications. These data can be particularly valuable in future programs where the major emphasis will be to use existing equipment in new applications. (When modal survey is ruled out for programmatic reasons, a simple resonance search can sometimes provide useful information.)

3.1 Pretest.

The following information is required to conduct vibration tests adequately.

- a. General. See Part One, paragraphs 5.7 and 5.9, and Part One, Annex A, Task 405 of this Standard.
- b. Specific to this Method.
 - (1) Test fixture requirements.
 - (2) Test fixture modal survey requirements / procedure.
 - (3) Test item/fixture modal survey requirements / procedure.
 - (4) Vibration exciter control strategy.
 - (5) Test tolerances.

MIL-STD-810H
METHOD 528.1

- (6) Requirements for combined environments.
 - (7) Test schedule(s) and duration of exposure(s).
 - (8) Axes of exposure.
 - (9) Measurement instrumentation configuration.
 - (10) Test shutdown procedures for test equipment or test item problems, failures, etc. (See paragraph 4.3.)
 - (11) Test interruption recovery procedure. (See paragraph 4.3.)
 - (12) Test completion criteria.
 - (13) Assure that test requirements (force, acceleration, velocity, displacement) can be met. Seek approval for variation if required. Document any variation.
 - (14) Allowable adjustments to test item & fixture (if any); **these must be documented in the test plan and the test report.**
 - (15) Check bolts and washers before, during (when changing direction of vibration), and after test. Ensure all bolts are proper grip length and that the washers are not rotating.
 - (16) Identify potential areas of high stress concentration. Consider composite and cast materials.
- c. Tailoring. Necessary variations in the basic test parameters/testing equipment to accommodate LCEP requirements and/or facility limitations. Tailoring is a function of the ship's propulsion system and the environment. All tailoring of this test Method must be approved in accordance to the procurement specification before testing.

NOTE: Modal surveys of both test fixtures and test items can be extremely valuable. Large test items on large complex fixtures are almost certain to have fixture resonances within the test range. These resonances result in large overtests or undertests at specific frequencies and locations within a test item. Where fixture and test item resonances couple, the result can be misleading. Similar problems often occur with small test items, even when the shaker/fixture system is well designed. In cases where the fixture/item resonance coupling cannot be eliminated, consider special vibration control techniques such as acceleration or force limit control.

3.2 During Test.

- a. General. See Part One, paragraph 5.10, and Part One, Annex A, Tasks 405 and 406 of this Standard.
- b. Specific to this Method.
 - (1) Document any adjustments to the test item and fixture identified by the test plan, including planned stopping points. (See also paragraph 4.3.3.)
 - (2) Document the vibration exciter control strategy used, e.g., single point response, multipoint response, force limit, waveform, etc.
 - (3) Refer to the test-specific plan to address any additional data that may be required during the test phase.
 - (4) Check bolts and washers during testing (including when changing direction of vibration). Ensure all washers are not rotating.

3.3 Post-Test.

The following post-test information shall be included in the test report:

- a. General. See Part One, paragraph 5.13, and Part One, Annex A, Task 406 of this Standard.
- b. Specific to this Method.

MIL-STD-810H
METHOD 528.1

- (1) Summary and chronology of test events, test interruptions, and test failures.
- (2) Discussion and interpretation of test events.
- (3) Functional verification data.
- (4) Test item modal analysis data.
- (5) All vibration measurement data.
- (6) Documentation of any test requirement variation (paragraph 3.1 b (14)).
- (7) Any changes from the original test plan.

4. GENERAL REQUIREMENTS – TEST PROCESS.

- a. **Notification of tests.** When specified (see Annex B, paragraph 2b), notification of Type I or Type II testing shall be made in accordance with DI-MISC-81624 (see Annex B, paragraph 3).
- b. **Identification of component compliance.** When specified (see Annex B, paragraph 2c), the information verifying that the component complies with Type I and Type II testing shall be identified on the component drawing, the Test Report (DI-ENVR-81647) (see Annex B, paragraph 3), or an identification plate attached to the component.
- c. **Disposition of tested equipment.** The requirements for tested equipment, fixturing, associated test records, and other documentation shall be as specified (see Annex B, paragraph 2d).

4.1 Test Facility.

Use a test facility, including all auxiliary equipment, capable of providing the specified vibration environments and the control strategies and tolerances discussed in paragraph 4.2. In addition, use measurement transducers, data recording and data reduction equipment capable of measuring, recording, analyzing, and displaying data sufficient to document the test and to acquire any additional data required. Unless otherwise specified, perform the specified vibration tests, and take measurements at standard ambient conditions as specified in Part One, paragraph 5.1.

4.2 Controls.

The accuracy in providing and measuring vibration environments is highly dependent on fixtures and mountings for the test item, the measurement system, and the exciter control strategy. Ensure all instrumentation considerations are in accordance with the best practices available (see paragraph 6.1, reference j). Careful design of the test set up, fixtures, transducer mountings, and wiring, along with good quality control will be necessary to meet the tolerances of paragraph 4.2.2 below.

4.2.1 Control Strategy.

Select a control strategy that will provide the required vibration at the required location(s) in or on the test item. Base this selection on the characteristics of the vibration to be generated and platform/ equipment interaction (see paragraph 1.3b above and Method 514.8, Annex A, paragraph 2.4). Generally, a single strategy is appropriate. There are cases where multiple strategies are used simultaneously.

4.2.1.1 Acceleration Input Control Strategy.

Input control is the traditional approach to vibration testing. Control accelerometers are mounted on the fixture at the test item mounting points. Exciter motion is controlled with feedback from the control accelerometer(s) to provide defined vibration levels at the fixture/test item interface. Where appropriate, the control signal can be the average (weighted average or maxima) of the signals from more than one test item/fixture accelerometer. This represents the platform input to the equipment, and assumes that the equipment does not influence platform vibration.

4.2.1.2 Force Control Strategy.

Dynamic force gages are mounted between the exciter/fixture and the test item. Exciter motion is controlled with feedback from the force gages to replicate field measured interface forces. This strategy is used where the field (platform/ equipment) dynamic interaction is significantly different from the laboratory (exciter/test item) dynamic interaction. This form of control inputs the correct field-measured forces at the interface of the laboratory vibration

MIL-STD-810H
METHOD 528.1

exciter and test item. This strategy is used to prevent overtest or undertest of equipment mounts at the lowest structural resonances that may otherwise occur with other forms of control.

4.2.1.3 Acceleration Limit Strategy.

Input vibration criteria are defined as in paragraph 4.2.1.1. In addition, vibration response limits at specific points on the equipment are defined (typically based on field measurements). Monitoring accelerometers are located at these points. The test item is excited as in paragraph 4.2.1.1 using test item mounting point accelerometer signals to control the exciters. The input criteria are experimentally modified as needed to limit responses at the monitoring accelerometers to the predefined limits. Changes to the specified input criteria are limited in frequency bandwidth and in level to the minimum needed to achieve the required limits.

4.2.1.4 Acceleration Response Control Strategy.

Vibration criteria are specified for specific points on, or within the test item. Control accelerometers are mounted at the vibration exciter/fixture interface. Monitoring accelerometers are mounted at the specified points within the item. An arbitrary low level vibration, controlled with feedback from the control accelerometers, is input to the test item. The input vibration is experimentally adjusted until the specified levels are achieved at the monitoring accelerometers. This strategy is commonly used with assembled aircraft stores where store response to the dynamic environment is measured or estimated. It is also applicable for other equipment when field measured response data are available.

4.2.1.5 Waveform Control Strategy.

This strategy is discussed in Method 525.2.

4.2.2 Tolerances.

Use the following tolerances unless otherwise specified. In cases where these tolerances cannot be met, achievable tolerances should be established and agreed to by the cognizant engineering authority and the customer prior to initiation of test. Protect measurement transducer(s) to prevent contact with surfaces other than the mounting surface(s).

4.2.2.1 Acceleration Spectral Density.

Carefully examine field measured response probability density information for non-Gaussian behavior. In particular, determine the relationship between the measured field response data and the laboratory replicated data relative to three sigma peak limiting that may be introduced in the laboratory test. The random vibration testing is restricted to combatants with skewed propellers. The alternating thrust of these propellers cannot exceed ± 1.5 percent of full power mean thrust.

- a. Vibration environment. The following discussion relates the measured vibration level to the specification level and, like the control system, does not consider any measurement uncertainty. The test tolerance should be kept to the minimum level possible considering the test item, fixturing, and spectral shape. Test tolerances of less than $+2$ dB are usually readily attainable with small, compact test items (such as small and medium sized rectangular electronic packages), well-designed fixtures, and modern control equipment. When test items are large or heavy, when fixture resonances cannot be eliminated, or when steep slopes (> 20 dB/octave) occur in the spectrum, these tolerances may have to be increased. When increases are required, exercise care to ensure the selected tolerances are the minimum attainable, and that attainable tolerances are compatible with test objectives. In any case, tolerances should not exceed ± 3 dB. These tolerances should be limited to a maximum of 5 percent of the test frequency range. Otherwise, change the tests, fixtures, or facilities so test objectives can be met. The rms level of the vibration test should not deviate more than ± 10 percent from the required level.
- b. Vibration measurement. Use a vibration measurement system that can provide acceleration spectral density measurements within ± 0.5 dB of the vibration level at the transducer mounting surface (or transducer target mounting surface) over the required frequency range. Do not use a measurement bandwidth that exceeds 2.5 Hz at 25 Hz or below, or 5 Hz at frequencies above 25 Hz. Use a frequency resolution appropriate for the application (i.e., generally in wheeled vehicles, a resolution of 1 Hz is sufficient).
- c. Swept narrow-band random on random vibration tests may require lesser degrees of freedom due to sweep time constraints.

MIL-STD-810H
METHOD 528.1

- d. Root mean square (RMS) “g”. RMS levels are useful in monitoring vibration tests since RMS can be monitored continuously, whereas measured spectra are available on a delayed, periodic basis. Also, RMS values are sometimes useful in detecting errors in test spectra definition.

4.2.2.2 Peak Sinusoidal Acceleration.

- a. Vibration environment. Validate the accelerometer(s) sensitivity before and after testing. Ensure the peak sinusoidal acceleration at a control transducer does not deviate from that specified by more than ± 10 percent over the specified frequency range.
- b. Vibration measurement. Ensure the vibration measurement system provides peak sinusoidal acceleration measurements within ± 5 percent of the vibration level at the transducer mounting surface (or transducer target mounting surface) over the required frequency range.

4.2.2.3 Frequency Measurement.

Ensure the vibration measurement system provides frequency measurements within ± 1.25 percent at the transducer mounting surface (or transducer target mounting surface) over the required frequency range.

4.2.2.4 Cross Axis Sensitivity.

Ensure vibration acceleration in two axes mutually orthogonal and orthogonal to the drive axis is less than or equal to 0.45 times the acceleration (0.2 times the spectral density) in the drive axis over the required frequency range. In a random vibration test, the cross axis acceleration spectral density often has high but narrow peaks. Consider these in tailoring cross-axis tolerances.

4.3 Test Interruption.

Test interruptions can result from multiple situations. The following paragraphs discuss common causes for test interruptions and recommended paths forward for each. Recommend test recording equipment remain active during any test interruption if the excitation equipment is in a powered state.

4.3.1 Interruption Due to Laboratory Equipment Malfunction.

- a. General. See Part One, paragraph 5.11 of this Standard.
- b. Specific to this Method. When interruptions are due to failure of the laboratory equipment, analyze the failure to determine root cause. It is also strongly advised that both control and response data be evaluated to ensure that no undesired transients were imparted to the test item during the test equipment failure. If the test item was not subjected to an over-test condition as a result of the equipment failure, repair the test equipment or move to alternate test equipment and resume testing from the point of interruption. If the test item was subjected to an over-test condition as a result of the equipment failure, the test engineer or program engineer responsible for the test article should be notified immediately. A risk assessment based on factors such as level and duration of the over-test event, spectral content of the event, cost and availability of test resources, and analysis of test specific issues should be conducted to establish the path forward. See Method 514.8, Annex A, paragraph 2.1 for descriptions of common test types, and a general discussion of test objectives.

4.3.2 Interruption Due to Test Item Operation Failure.

Failure of the test item(s) to function as required during operational checks presents a situation with several possible options. Failure of subsystems often has varying degrees of importance in evaluation of the test item. Selection of option a through c below will be test specific.

- a. The preferable option is to replace the test item with a “new” one and restart the entire test.
- b. An alternative is to replace / repair the failed or non-functioning component or assembly with one that functions as intended, and restart the entire test. A risk analysis should be conducted prior to proceeding since this option places an over-test condition on the entire test item except for the replaced component. If the non-functioning component or subsystem is a line replaceable unit (LRU) whose life-cycle is less than that of the system test being conducted, proceed as would be done in the field by substituting the LRU, and continue from the point of interruption.
- c. For many system level tests involving either very expensive or unique test items, it may not be possible to acquire additional hardware for re-test based on a single subsystem failure. For such cases, a risk assessment

MIL-STD-810H
METHOD 528.1

should be performed by the organization responsible for the system under test to determine if replacement of the failed subsystem and resumption of the test is an acceptable option. If such approval is provided, the failed component should be re-tested at the subcomponent level.

NOTE: When evaluating failure interruptions, consider prior testing on the same test item and consequences of such.

4.3.3 Interruption Due to a Scheduled Event.

There are often situations in which scheduled test interruptions will take place. For example, in a tactical transportation scenario, the payload may be re-secured to the transport vehicle periodically (i.e., tie-down straps may be re-secured at the beginning of each day). Endurance testing often represents a lifetime of exposure; therefore it is not realistic to expect the payload to go through the entire test sequence without re-securing the tie-downs as is done in a tactical deployment. Many other such interruptions, to include scheduled maintenance events, are often required over the life-cycle of equipment. Given the cumulative nature of fatigue imparted by dynamic testing, it is acceptable to have test interruptions that are correlated to realistic life-cycle events. All scheduled interruptions should be documented in the test plan and test report.

4.3.4 Interruption Due to Exceeding Test Tolerances.

Exceeding the test tolerances defined in paragraph 4.2.2, or a noticeable change in dynamic response may result in a manual operator initiated test interruption or an automatic interruption when the tolerances are integrated into the control strategy. In such cases, the test item, fixturing, and instrumentation should be checked to isolate the cause.

- a. If the interruption resulted from a fixturing or instrumentation issue, correct the problem and resume the test.
- b. If the interruption resulted from a structural or mechanical degradation of the test item, the problem will generally result in a test failure and requirement to re-test unless the problem is allowed to be corrected during testing. If the test item does not operate satisfactorily, see paragraph 5 for analysis of results and follow the guidance in paragraph 4.3.3 for test item failure.

5. DETAILED REQUIREMENTS.

5.1 Procedure I (Type I) – Environmental Vibration.

When Type I vibration requirements are specified (see Annex B, paragraph 2e), the test item shall be subjected to a simulated environmental vibration as may be encountered aboard Naval ships. This Method provides an amplitude sufficiently large within the selected frequency range to obtain a reasonably high degree of confidence that equipment will not malfunction during service operation.

- a. For Type I vibration testing, this Method shall be used for equipment subjected to the vibration environment found on Navy ships with conventionally shafted propeller propulsion.
- b. For Type I vibration testing this Method can be tailored for non-conventional Navy shafted propeller systems such as waterjet, podded, or other propulsor types, including those that have been designed to minimize blade-rate forces. The revised test Method shall be recommended by the purchaser and approved by the Government.
- c. For equipment installed on ships with propulsion systems with frequency ranges not covered by Table 528.1-I, this Method shall not apply.

5.1.1 Basis of Acceptability.

For equipment that can be vibration tested, acceptability shall be contingent on the ability of the equipment to withstand tests specified, and the ability to perform its principal functions during and after vibration tests. Minor damage or distortion will be permitted during the test, providing such damage or distortion does not in any way impair the ability of the equipment to perform its principal functions (see Annex B, paragraphs 2f(1) and 2f(6)). Because of the numerous types of equipment covered by this Method, a definite demarcation between major and minor failures cannot be specified. Therefore, during testing acceptability a determination shall be made as to whether or not a failure

MIL-STD-810H
METHOD 528.1

is minor or major to determine whether testing should continue (see Annex B, paragraph 2f(2)). In general, a major failure is one that would cause mal-operation or malfunction of the item of equipment for a long period. Non-repetitive failures of such parts as connectors, knobs/buttons, certain fasteners, and wiring, that can be easily replaced or repaired, are generally considered minor failures. As such, the repair could be made and the test continued with no penalty to the remainder of the test item. The critical use of the equipment shall be considered when determining the category of failure; e.g., a failure of a part in a lighting circuit may be considered minor. The same failure in a control circuit may be major.

5.1.2 Test Procedures.

The tests specified herein are intended to expose equipment to:

- a. Vibration magnitudes in prescribed frequency and amplitude ranges to reveal any critical response prominences (see paragraph 2.2v) or potential deficiencies.
- b. A 2-hour minimum endurance test at the response prominence frequency or frequencies most seriously affecting its functional or structural integrity.

5.1.2.1 Testing Machine.

Vibration tests shall be made by means of any testing machine capable of meeting the conditions specified in paragraph 5.1.2.4, and the additional requirements contained herein. Means shall be provided for controlling the direction of vibration of the testing machine, and for adjusting and measuring its frequencies and the amplitude of vibration to keep them within prescribed limits. It is acceptable to use different machines for the vertical and horizontal directions. The testing machine, including table, actuator, and attachment fixtures, shall be rigid within the frequency range to be tested. This includes test fixture resonances that may result from interaction between the table and mounted test items. Testing machine rigidity shall be demonstrated by analysis, or by measuring transmissibility in accordance with paragraph 5.1.2.2d.

5.1.2.2 Additional Test Instrumentation.

Vibration measurement transducers such as accelerometers shall be installed on the test item to aid in the determination of response prominences during the exploratory and variable frequency vibration tests of paragraphs 5.1.2.4.2 and 5.1.2.4.3. The number, orientation, and placement of vibration transducers will depend upon the equipment under test, and should be sufficient to provide a suitable survey for identifying response prominences of the tested equipment and testing machine. When required, approval of transducer locations shall be obtained from the procuring activity (see Annex B, paragraph 2f(3)). Guidance below shall be used in the selection of measurement locations:

- a. Measurements shall be made at locations corresponding to components or areas on the equipment of particular concern for operation of the equipment, whose failure would impair the ability of the equipment to perform its principal function. Such locations shall be determined prior to test.
- b. Select a sufficient number of measurement locations such that the response of the test item is measured at locations near the base, top, and center of the test item to measure response prominences associated with global motion of the equipment. Attach these transducers to rigid areas of the test item representing major structural components such as the housing, shell, or body of the equipment.
- c. The transducers shall be oriented to measure vibration in the direction of the vibration excitation provided for any given test. If necessary, transducers may be re-oriented between tests.
- d. If the testing machine rigidity has not been demonstrated by analysis, a sufficient number of transducers shall be located on the testing machine to demonstrate that the testing machine is rigid over the frequency range of the test. At a minimum, locate these transducers at the point of force application to the table, and at the test item attachment interface(s) to the testing machine.

5.1.2.3 Methods of Attachment.**5.1.2.3.1 Shipboard Equipment.**

For all tests, the test item shall be secured to the testing machine at the same points or areas of attachment that will be used for securing it shipboard. In case alternate attachment points or areas are specified, tests shall be performed using each attachment configuration. Equipment that is hard mounted (i.e., not isolation mounted) aboard ship shall be hard mounted to the testing machine. For equipment designed to be secured to a deck and a head brace support, a vertical

MIL-STD-810H
METHOD 528.1

bracket shall be used to simulate a bulkhead. The bracket shall be sufficiently rigid to ensure that its motion will be essentially the same as the motion of the platform on the testing machine. For isolation mounted shipboard equipment, see paragraph 5.1.2.3.4.

5.1.2.3.2 Shipboard Portable and Test Equipment.

Portable and test equipment that is designed for permanent or semi-permanent attachment to a ship structure shall be attached to the vibration testing machines in the same manner it is attached to the ship. Equipment that is not designed for permanent or semi-permanent attachment shall be secured to the testing machine by suitable means.

5.1.2.3.3 Orientation for Vibration Test.

Test items shall be installed on vibration testing machines in such a manner that the direction of vibration will be, in turn, along each of the three rectilinear orientation axes of the equipment as installed on shipboard – vertical, athwartship, and fore and aft. On a horizontal vibration-testing machine, the test item may be turned 90 degrees in the horizontal plane in order to vibrate it in each of the two horizontal orientations. At no time shall the test item be installed in any other way than its normal shipboard orientation.

5.1.2.3.4 Isolation Mountings.

For Type I testing of equipment to be installed shipboard on isolation mounts, testing shall be performed on isolation mounts or hard mounted to the testing machine, or as specified (see Annex B, paragraph 2f(4)). Type I testing of a particular test item on isolation mounts is valid only for the isolation mount type and configuration used during testing. Ensure the transmissibility across the mounts does not exceed 1.5 within the blade frequency range of 80 percent to 115 percent of design RPM. If equipment is tested for Type I vibrations hard mounted to the test fixture throughout the duration of the test, the test is valid for either hard mounted or isolation mounted shipboard installations, provided the isolation mounts are Navy standard mounts contained in MIL-M-17191, MIL-M-17508, MIL-M-19379, MIL-M-19863, MIL-M-21649, MIL-M-24476 (see paragraph 6.1, references a-f), or distributed isolation equipment (DIM).

5.1.2.3.5 Internal Isolation or Shock Mountings.

Equipment that incorporates other isolation mountings integrally within the equipment box (such as electronic cabinets) shall be tested with the internal mountings in the normal shipboard configuration or as specified (see Annex B, paragraph 2f(5)).

5.1.2.4 Vibration Tests.

Each of the tests specified shall be conducted separately in each of the three principal directions of vibration. All tests in one direction shall be completed before proceeding to tests in another direction. The test item shall be secured to the vibration table as specified in paragraph 5.1.2.3. If major damage occurs (see paragraphs 4.3 and 5.1.1), the test shall be discontinued, and the entire test shall be repeated following repairs or correction of deficiencies.

5.1.2.4.1 Equipment Operation.

Except as noted below, the test item shall be energized or operated to perform its normal functions (see Annex B, paragraph 2f(6)). Equipment that is difficult to operate on the testing machine shall be energized and subjected to operating conditions during the test. The test item shall then be operated after the test to demonstrate that there is no damage from the test (see Annex B, paragraph 2f(1)).

5.1.2.4.2 Exploratory Vibration Test.

To determine the presence of response prominences (see paragraph 2.2v) in the test item, it shall be secured to the vibration table and vibrated at frequencies from 4 Hz to 33 Hz, at a table vibratory single amplitude of 0.010 ± 0.002 inch (see paragraphs 5.1.2.4.4 and 5.1.2.4.5 for exceptions). The change in frequency shall be made in discrete frequency intervals of 1 Hz, and maintained at each frequency for about 15 seconds. Alternatively, a continuous frequency sweep with a rate of change of frequency not to exceed 0.067 Hz/second can be used. The frequencies at which functional or structural requirements are affected or violated and frequencies and locations at which response prominences occur shall be recorded, and these frequencies (rounded to the nearest integer frequency if discrete frequency intervals were not used) shall be considered as candidates for endurance testing (see Annex A).

MIL-STD-810H
METHOD 528.1**5.1.2.4.3 Variable Frequency Test.**

The test item shall be vibrated from 4 Hz to 33 Hz in discrete frequency intervals of 1 Hz, and at the amplitudes shown in Table 528.1-I (see paragraphs 5.1.2.4.4 and 5.1.2.4.5 for exceptions). At each integral frequency, the vibration shall be maintained for 5 minutes. The frequencies, at which functional or structural requirements are affected or violated, and frequencies and locations at which response prominences occur, shall be recorded. Note that because of increased amplitudes compared to those in paragraph 5.1.2.4.2, response prominences and effects on or violations of functional or structural requirements may show up in this test that were not uncovered in the exploratory vibration test. Therefore, the frequencies at which these response prominences and effects on or violations of functional or structural requirements occur shall also be considered as candidates for endurance testing (see Annex A).

Table 528.1-I. Vibratory displacement of environmental vibration.

Frequency range (Hz)	Table single amplitude (inch)
4 to 15	0.030 ±0.006
16 to 25	0.020 ±0.004
26 to 33	0.010 ±0.002

5.1.2.4.4 Exception.

Equipment intended for installation solely on a particular ship class need only be vibrated in the exploratory and variable frequency tests from 4 Hz to (1.15 x design rpm x number of propeller blades/60) rounded up to the nearest integer frequency or the maximum test frequency as specified by the purchaser and approved by the Government.

5.1.2.4.5 Alternative Test Amplitudes.

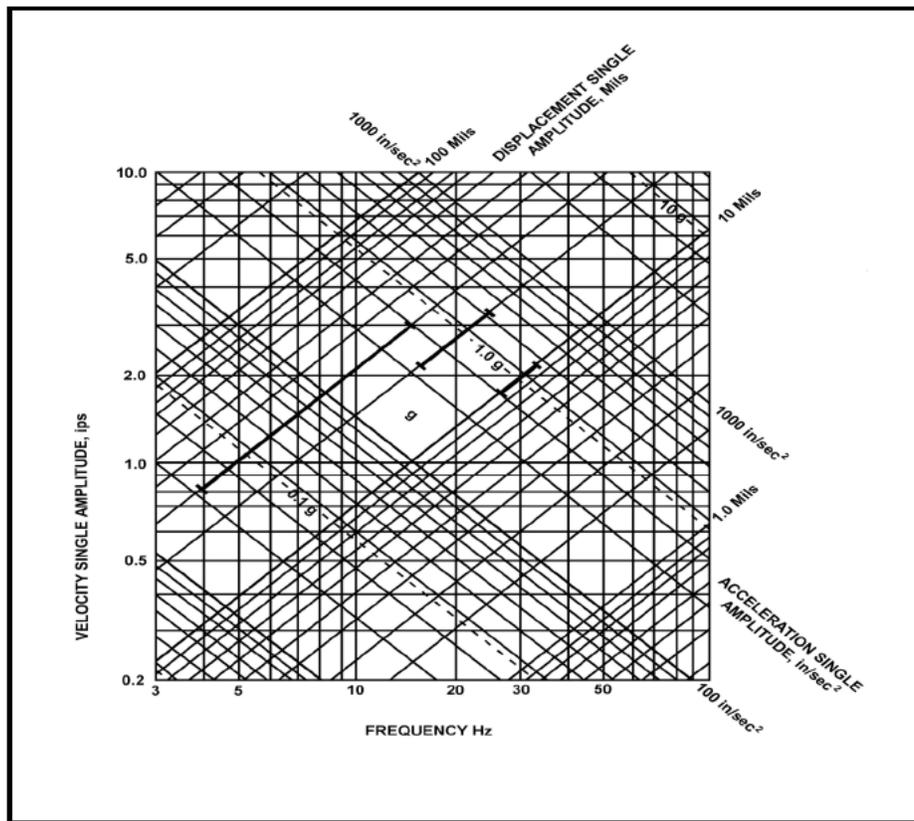
For equipment installed on ships with advanced isolation systems, low vibration propellers, or other reduced environment vibration conditions, the alternative test amplitudes can be reduced. A reduction in test amplitude shall be recommended by the purchaser and approved by the Government.

5.1.2.4.6 Endurance Test.

Endurance test frequencies are selected from the candidate list of endurance test frequencies developed during exploratory and variable frequency testing (see paragraphs 5.1.2.4.2 and 5.1.2.4.3). When specified (see Annex B, paragraph 2f(9)), selection of these frequencies is subject to approval. The test item shall be vibrated for a total period of at least 2 hours at the frequency determined to most seriously affect the functional or structural integrity of the equipment. Guidance for selecting response prominences from exploratory or variable frequency testing, for determining whether a response prominence is significant, and if the more serious response prominences can be identified, is given in Annex A. In cases where there are multiple response prominence frequencies selected, the duration of vibration testing at each frequency shall be in accordance with Table 528.1-II. If neither response prominences nor effects on equipment structural/functional performance are observed, this test shall be performed at 33 Hz or at the upper frequency as specified in paragraph 5.1.2.4.4. Ensure the amplitudes of vibration are in accordance with Table 528.1-I, unless otherwise specified (see paragraph 5.1.2.4.5). See Figure 528.1-1 for a graphical representation of the amplitudes in Table 528.1-I.

MIL-STD-810H
METHOD 528.1**Table 528.1-II. Duration of endurance test in a given orthogonal direction at each test frequency.**

Number of endurance test frequencies	Test time duration at each endurance test frequency	Total time
1	2 hours	2 hours
2	1 hour	2 hours
3	40 minutes	2 hours
4	40 minutes	2 hours, 40 minutes
n>2	40 minutes	40 x n minutes

**Figure 528.1-1. Type I environmental vibration limits (black bars represent a graphical presentation of Table 528.1-I expressed in displacement, velocity, and acceleration)****5.1.2.4.7 Endurance Test for Mast Mounted Equipment.**

Equipment intended for installation on masts, such as radar antennae and associated equipment, shall be designed for a static load of 2.5g (1.5g over gravity) in vertical and transverse (athwartship and longitudinal) directions to compensate for the influence of rough weather. In addition, the test item shall be vibrated for a total period of at least 2 hours at the response prominences chosen by the test engineer. When specified (see Annex B, paragraph 2f(9)), selection of these frequencies is subject to approval. If no response prominences were observed, this test shall be performed at 33 Hz, unless excepted by paragraph 5.1.2.4.4, in which case use the maximum frequency specified in paragraph 5.1.2.4.4 shall be used. The amplitudes of vibration shall be in accordance with Table 528.1-III.

MIL-STD-810H
METHOD 528.1**Table 528.1-III. Vibratory displacement of environmental vibration for mast mounted equipment.**

Frequency Range (Hz)	Table Single Amplitude (inch)
4 to 10	0.100 ± 0.010
11 to 15	0.030 ± 0.006
16 to 25	0.020 ± 0.004
26 to 33	0.010 ± 0.002

5.1.2.5 Test Documentation.**5.1.2.5.1 Test Plan.**

When specified (see Annex B, paragraph 2b), an equipment test plan shall be prepared for Type I tests in accordance with DI-ENVR-81647 (see Annex B, paragraph 3). The test plan shall specify, describe, or define all requirements, and shall be approved by the acceptance authority prior to the test as specified (see Annex B, paragraph 2f(10)).

5.1.2.5.2 Test Report.

A test report (see Annex B, paragraph 2b) for Type I tests shall be prepared in accordance with DI-ENVR-81647 (see Annex B, paragraph 3), and shall be approved by the acceptance authority as specified (see Annex B, paragraph 2f(10)).

5.1.3 Exemption.

If equipment size, weight, or center-of-gravity precludes testing on existing vibration facilities, the test item may be qualified by analysis or individually testing integral parts of the equipment, as approved by the acceptance authority. To facilitate this analysis process, the equipment could be shock tested to determine the natural frequencies. If the measured frequencies do not clear the blade rate by 25 percent, the equipment should be stiffened, and thereby, its vibration resistance increased.

5.1.4 Extension of Previous Testing.

Equipment that is identical or similar to previously tested equipment may qualify for an extension of the previously approved test. The equipment for which the testing is to be extended must meet all of the following criteria:

- a. The tested equipment and the proposed extension equipment are made of the same or similar equipment, and manufactured using the same or similar processes.
- b. The mass of the proposed extension equipment is no more than 10 percent greater than the mass of the tested equipment.
- c. The location of the center of gravity of the proposed extension equipment is within 10 percent of the location of the center of gravity of the tested equipment.

5.1.4.1 Extension Documentation.

A request for extension of previously approved testing must be approved by the acceptance authority and must contain the following:

- a. Detailed drawings of both the tested equipment and proposed extension equipment.
- b. A copy of the test report for the tested equipment.
- c. A detailed comparison of the differences in equipment and design showing that the proposed extension equipment has equal or greater vibration resistance than the tested equipment. This comparison should include at a minimum the information requested in paragraphs 5.1.4a, b, and c.

MIL-STD-810H
METHOD 528.1

5.1.5 Alignment Criteria.

- a. Equipment foundations should be such that they are devoid of natural frequencies within 25 percent of blade rate. If this guideline is not met, alignment issues will arise. That is, a tracker will not be able to home in on a target.
- b. Equipment foundation response should not exceed $1/7^{\text{th}}$ of the vibration displacement of environmental vibration. For combatants with an alternating thrust between ± 1 and ± 1.5 percent, Standardization Activity SH (NAVSEA 05P12) can allow a response of up to $2/7^{\text{th}}$. If this guideline is not met, alignment issues can arise.
- c. In order to reduce tracker alignment issues, a 57 mm gun, for example, should be designed with a total foundation impedance of 400 lb sec/in.
- d. Superstructure deck response should not exceed $1/7^{\text{th}}$ of vibratory displacement of environmental vibration for the mast mounted equipment. If this guidance is not met, the tracker can lose control with the satellite.

5.2 Procedure II (Type II) – Internally Excited Vibration.

Unless otherwise specified (see Annex B, paragraph 2e), Type II balance and vibration requirements shall apply to the procurement of rotating machinery. This does not apply to suitability from a noise standpoint, nor does it apply to reciprocating machinery. Special vibration and balance requirements may be specified (see Annex B, paragraph 2g(1)). The limitations set forth herein may also be used as criteria on overhaul tolerances, but should not constitute a criterion for the need for overhaul.

5.2.1 Basis of Acceptability.

All rotating machinery shall be balanced to minimize vibration, bearing wear, and noise. Types of balancing shall be as specified in Table 528.1-IV. Machinery with rigid rotors shall meet the limits of allowable residual unbalance given in paragraph 5.2.2.2. For machinery with rotors that are unable to meet the balance requirements of rigid rotors, shall be balanced in accordance with the requirements of paragraph 5.2.3.1.

NOTE: The pitch of each propeller blade should be the same. If this is not the case, the added mass on the propeller blades will be different, and the propeller will be unbalanced.

Table 528.1-IV. Types of balancing.

Rotor Characteristics	Speed (rpm)	Type of Balancing	Balancing Methods and Limits
Rigid, $L/D \leq 0.5$	0 – 1000	Single-plane	5.2.2
	>1000	Two-plane	5.2.2
Rigid, $L/D > 0.5$	0 – 150	Single-plane	5.2.2
	>150	Two-plane	5.2.2
Flexible	All	Multi-plane (more than two planes)	5.2.3

^L L – Length of rotor, exclusive of shaft.

D – Diameter of rotor, exclusive of shaft.

MIL-STD-810H
METHOD 528.1**5.2.2 Balance Procedure for Rigid Rotors.****5.2.2.1 Balancing Methods for Rigid Rotors.**

Except for machinery operating below 150 rpm, all balancing shall be accomplished by means of balancing equipment requiring rotation of the work piece. This may be either shop or assembly balancing type equipment. The minimum detectable unbalance of the balancing machine used shall be below the residual unbalance specified in paragraph 2.2.2. Unless otherwise specified, see Annex B paragraph 2g(2)), for machinery rated at lower than 150 rpm, the rotor including shaft may be balanced by symmetrically supporting the rotor on two knife edges, and applying correction to attain a static balance.

5.2.2.2 Balance Limits for Rigid Rotors.

When balanced as specified in paragraph 5.2.2.1, the maximum allowable residual unbalance is given by the following formula:

$$\text{Given: } U = We \quad \text{and} \quad G = \omega e = 2\pi fe$$

Where: U is the maximum allowable residual unbalance

G is the total balance quality grade (mm/sec) as specified (see Annex B, paragraph 2g(3))

W is weight of the rotor (lbs)

N is the maximum rotor rpm

e is the eccentricity limit (mm)

It can be shown that:

$$U = \frac{60GW}{2\pi N} (\text{lbs} \cdot \text{mm})$$

or

$$U \cong \frac{6GW}{N} (\text{oz} \cdot \text{in})$$

For rigid rotors that operate below 1000 rpm, the total balance quality grade shall not exceed $G=2.5$ mm/s. For rigid rotors that operate at 1000 rpm and above, the total balance quality grade shall not exceed $G=1.0$ mm/s. For rigid rotors that require low noise, a balance quality grade of $G=1.0$ mm/s can be specified for all speeds (see Annex B, paragraph 2g(3)). For guidance on balance quality grades of rigid rotors, see ANSI S2.19.

In allocating an allowable unbalance (U) between two planes of correction, the allocation ratio must not be more than 2 to 1. The amount allocated to each plane must be proportional to the distance from the other plane to the center of gravity (cg) of the rotor divided by the total distance between planes. If the distance between the correction planes is 25.4cm (10 inches), and the cg is 10cm (4 inches) from plane 1, plane 1 would be allowed 60 percent of U , and plane 2 would be allowed 40 percent. If the cg was 5cm (2 inches) from plane 1, plane 1 would be allowed 67 percent of U (not 80 percent), and plane 2 would be allowed 33 percent (not 20 percent), because the allocation ratio cannot be more than 2 to 1.

When specified (see Annex B paragraph 2g(4)), the residual unbalance for equipment with rigid rotors shall not result in vibration displacements larger than specified in Figure 528.1-2, when tested as in paragraph 5.2.3.2.

MIL-STD-810H
METHOD 528.1

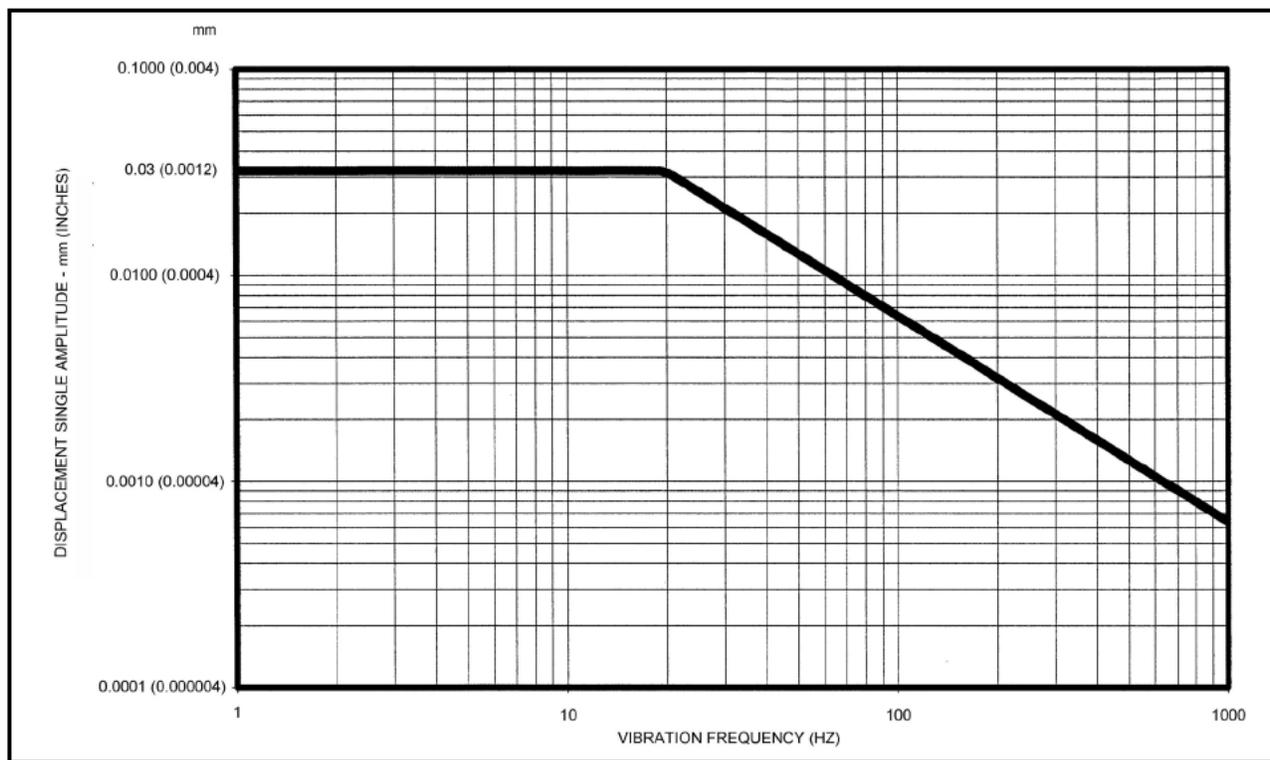


Figure 528.1-2. Vibration acceptance criteria for Type II vibration.

5.2.3 Balance Procedure for Flexible Rotors.

5.2.3.1 Balance Limits for Flexible Rotors.

The residual unbalance for flexible rotors shall not result in vibration displacements larger than specified in Figure 528.1-2 when tested as specified in paragraph 5.2.3.2.

5.2.3.2 Vibration Test Procedure.

When mounted as in paragraph 5.2.3.2.1 and measured in accordance with paragraph 5.2.3.2.2, the vibration displacement amplitude at the rotational frequency shall not exceed the values shown on Figure 528.1-2.

5.2.3.2.1 Mounting.

The test item shall be completely assembled and mounted elastically at a natural frequency corresponding to less than one-quarter of the frequency associated with the minimal operational speed of the equipment. To accomplish this, the minimum static deflection of the mounting should be determined by Figure 528.1-3, but in no case shall the deflection exceed one-half the original height of the elastic element. On machinery that cannot be mounted as described, the test item shall be mounted on the shipboard mounting for which it is intended, as specified (see Annex B, paragraph 2g(5)).

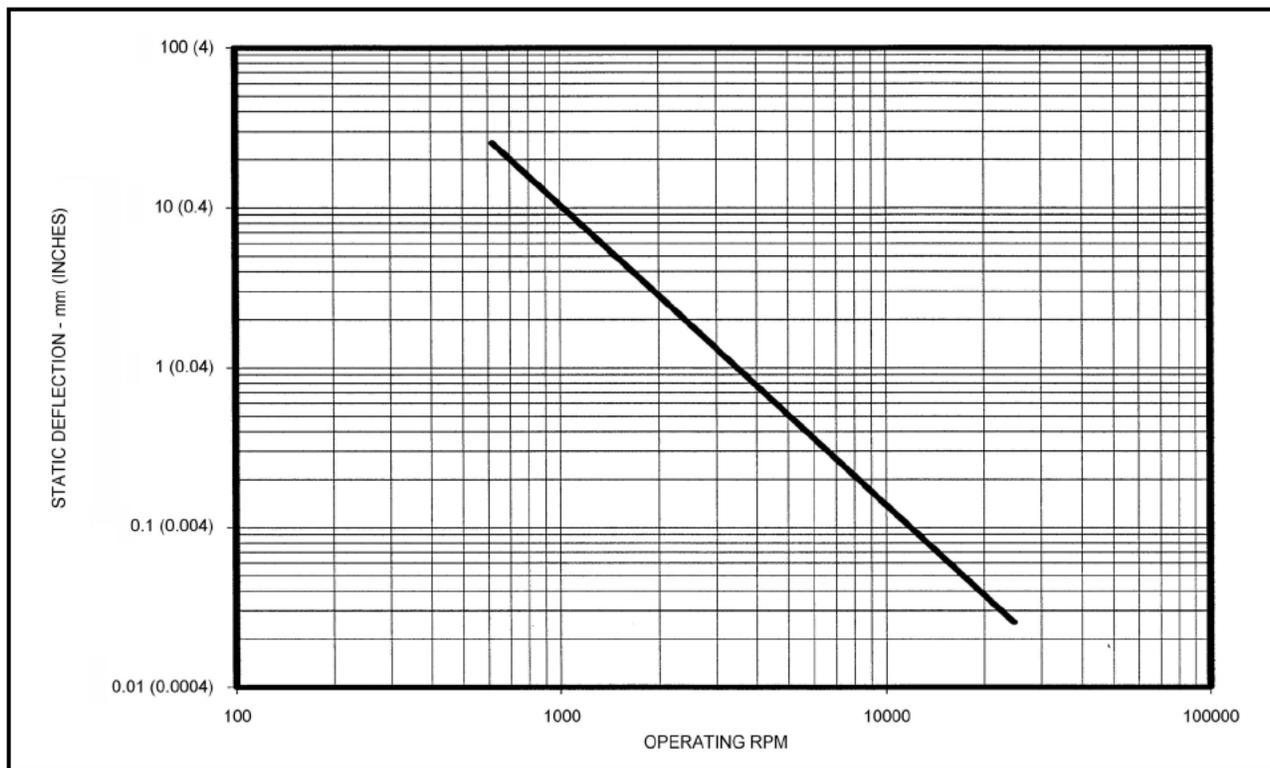
MIL-STD-810H
METHOD 528.1

Figure 528.1-3. Minimum static deflection of mounting for Type II vibration test.

5.2.3.2.2 Measurements.

Amplitudes of vibration shall be measured on the bearing housing in the direction of maximum amplitude. On constant speed units, measurements shall be made at the operating speed. In the case of variable speed units, measurements shall be made at maximum speed, and at all critical speeds (see paragraph 2.2h) within the operating range. Measurements at many speeds may be required to establish the existence of critical speeds of variable speed units. The maximum frequency step size used when establishing critical speeds shall be 0.25 Hz.

5.2.3.2.3 Instruments.

Amplitude and frequency measurements shall be performed with instrumentation that has calibration traceable to the National Institute of Standards and Technology (NIST), and that has dynamic and frequency ranges consistent with the amplitude and frequency range specified in Figure 528.1-2.

5.3 Analysis of Results.

In addition to the guidance provided in Part One, paragraph 5.14, the following is provided to assist in the evaluation of the test results.

5.3.1 Physics of Failure.

Analyses of vibration related failures must relate the failure mechanism to the dynamics of the failed item and to the dynamic environment. It is insufficient to determine that something broke due to high cycle fatigue or wear. It is necessary to relate the failure to the dynamic response of the equipment to the dynamic environment. Thus, include in failure analyses a determination of resonant mode shapes, frequencies, damping values and dynamic strain distributions, in addition to the usual equipment properties, crack initiation locations, etc. (See Method 514.8, Annex A, paragraph 2.5, as well as paragraph 6.1, references k and l).

5.3.2 Qualification Tests.

When a test is intended to show formal compliance with contract requirements, recommend the following definitions:

MIL-STD-810H
METHOD 528.1

- a. **Failure definition.** “Equipment is deemed to have failed if it suffers permanent deformation or fracture; if any fixed part or assembly loosens; if any moving or movable part of an assembly becomes free or sluggish in operation; if any movable part or control shifts in setting, position or adjustment, and if test item performance does not meet specification requirements while exposed to functional levels and following endurance tests.” Crack initiation in a critical structure constitutes failure of the test. Ensure this statement is accompanied by references to appropriate specifications, drawings, and inspection methods.
- b. **Test completion.** “A vibration qualification test is complete when all elements of the test item have successfully passed a complete test. When a failure occurs, stop the test, analyze the failure and repair the test item. Continue the test until all fixes have been exposed to a complete test. Each individual element is considered qualified when it has successfully passed a complete test. Elements that fail during extended tests are not considered failures, and can be repaired to allow test completion.” After testing, check all points of pre-identified stress concentration with a penetrating dye. This dye test will identify areas of crack initiation.

5.3.3 Other Tests.

For tests other than qualification tests, prepare success and/or failure criteria and test completion criteria that reflect the purpose of the tests.

6. REFERENCE/RELATED DOCUMENTS.

6.1 Referenced Documents.

- a. MIL-M-17191 Mounts, Resilient: Portsmouth Bonded Spool Type (1970)
- b. MIL-M-17508 Mounts, Resilient: Types 6E100, 6E150, 7E450, 6E900, 6E2000, 5E3500, 6E100BB, 6E150BB, 7E450BB, and 6E900BB
- c. MIL-M-24476 Mounts, Resilient: Pipe Support, Types 7M50, 6M150, 6M450, 6M900, and 5M3500
- d. MIL-M-19379 Mounts, Resilient, Mare Island Types 11M15, 11M25, and 10M50 (1961)
- e. MIL-M-19863 Mount, Resilient: Type 5B5, 000H
- f. MIL-M-21649 Mount, Resilient, Type 5M10, 000-H
- g. MIL-STD-167-1A Mechanical Vibrations of Shipboard Equipment (Type I – Environmental and Type II – Internally Excited)
- h. MIL-STD-167-2A Mechanical Vibrations of Shipboard Equipment (Reciprocating Machinery and Propulsion System and Shafting) Types III, IV, and V (Controlled Distribution)
- i. MIL-STD-740-2 Structureborne Vibratory Acceleration Measurements Acceptance Criteria of Shipboard Equipment
- j. Handbook for Dynamic Data Acquisition and Analysis, IEST-RD-DTE012.2; Institute of Environmental Sciences and Technology, Arlington Place One, 2340 S. Arlington Heights Road, Suite 100, Arlington Heights, IL 60005-4516; Institute of Environmental Sciences and Technology Website.
- k. NATO STANAG 4570, Evaluating the Ability of Equipment to Meet Extended Life Requirements; 2004; Information Handling Services Website.
- l. NATO Allied Environmental Engineering and Test Publication (AECTP) 600, “A Ten Step Method for Evaluating the Ability of Equipment to Meet Extended Life Requirements”; December 2004; Leaflet 604; NATO Website.

(Copies of these documents are available online at <https://assist.dla.mil>.)

6.2 Related Documents.

See Annex B, Table 528.1B-I.

Egbert, Herbert W. “The History and Rationale of MIL-STD-810 (Edition 2)”, December 2009; Institute of Environmental Sciences and Technology, Arlington Place One, 2340 S. Arlington Heights Road, Suite 100, Arlington Heights, IL 60005-4516.

MIL-STD-810H
METHOD 528.1

(Copies of Department of Defense Specifications, Standards, and Handbooks, and International Standardization Agreements are available online at <https://assist.dla.mil>.)

Requests for other defense-related technical publications may be directed to the Defense Technical Information Center (DTIC), ATTN: DTIC-BR, Suite 0944, 8725 John J. Kingman Road, Fort Belvoir VA 22060-6218, 1-800-225-3842 (Assistance--selection 3, option 2), <http://www.dtic.mil/dtic/>; and the National Technical Information Service (NTIS), Springfield VA 22161, 1-800-553-NTIS (6847), <http://www.ntis.gov/>.

MIL-STD-810H
METHOD 528.1

(This page is intentionally blank.)

MIL-STD-810H
METHOD 528.1 ANNEX A**METHOD 528.1, ANNEX A****IDENTIFYING RESPONSE PROMINENCES TO BE INCLUDED IN ENDURANCE TESTING****1. SCOPE.**

This Annex details the procedures for identifying response prominences to be included in endurance testing. This Annex is not a mandatory part of this Method. The following information is intended for guidance only.

2. PROCEDURE.**2.1 Determining and Displaying Transmissibility.**

Present transmissibility information using the output responses and prescribed inputs. Use the transmissibility magnitudes for both exploratory and variable frequency tests for response prominence determinations.

2.1.1 Transmissibility Magnitudes.

Develop transmissibility magnitudes by dividing the measured output amplitudes by the input amplitudes using consistent units (e.g., acceleration in gs or inches/sec²).

2.1.2 Transmissibility and Frequency.

Present transmissibility information in linear-linear format. Plots or tabulations are acceptable. Present both the transmissibility and frequency information in linear units (i.e., do not use logarithms or dB of either frequency or transmissibility to compute or display the data used for response prominence determinations).

2.2 Identifying Response Prominences.

Regardless of whether or not the transmissibility exceeds 1.0, find all local maxima in the transmissibility magnitude-frequency data and include the frequency endpoints in the list of maxima.

- a. For each of these maxima, determine if there is reason to believe that the maximum is attributable to an instrumentation error, a fixture resonance or from a numerical error related to computation of the transmissibility (round-off errors may appear as maxima). Any maxima that are attributable to an instrumentation error, fixture resonance, or numerical errors must be discarded as a potential response prominence. Fixture resonances are not permitted, and refixturing must be employed to eliminate such resonances.
- b. Examine the end points for indications that a resonance may exist outside the test frequency range.
- c. An initial decrease in transmissibility with increasing frequency above the frequency of the lower end point suggests a potential response prominence outside the lower bound of the test frequency range. If this condition is observed and is not attributed to shaker problems at low frequencies, include the lower endpoint in the candidate list of endurance test frequencies noting whether or not it affects functional or structural integrity. If this condition is not observed, the lower bound test frequency may be discarded as a potential response prominence. At these low frequencies, noticeable displacement magnitude amplifications may occur if a true response prominence exists below the lower frequency bound of testing and this fact may be used to help determine the nearby presence of a true response prominence.
- d. Similarly, an increase in transmissibility with increasing frequency near the upper bound test frequency suggests a potential response prominence outside the upper bound of the test frequency range. If this condition is observed, include the upper endpoint in the candidate list of endurance test frequencies noting whether or not it affects functional or structural integrity. If it is not observed, this frequency cannot be excluded from the list of endurance test frequencies unless other response prominence frequencies are found.
- e. Observe whether or not equipment function (if permitted by the ordering data) or structural integrity is affected at any of the frequencies used in exploratory or variable frequency testing. Include those frequencies at which equipment functional or structural integrity is affected in the candidate list of endurance test frequencies. Also include frequencies at which maxima occur in the candidate list of endurance test frequencies if the impact on functional/structural performance cannot be established.

MIL-STD-810H
METHOD 528.1 ANNEX A

- f. Examine the remaining maxima for classic signs of resonance (i.e., a moderate to rapid increase in transmissibility to the peak followed by a moderate to rapid decrease in the transmissibility with increasing frequency after the peak suggests that a response prominence may exist in this region) and include any maxima that exhibit these characteristics in the candidate list of endurance test frequencies.

2.3 Selecting Endurance Test Frequencies.

2.3.1 Non-responsive Prominence Frequencies Where Functional or Structural Integrity Is Affected.

Include in the list of endurance test frequencies, any frequency at which a structural, functional, mechanical, or electrical anomaly has occurred (if permitted by the acceptance criteria (see paragraph 5.1.1 at the beginning of this Method, as well as Annex B, paragraph 2f(1)). Examples of these manifestations could be unexpected switch closures, unexpected changes in pressure or flow, variations in voltage, current, etc. The frequencies where any minor impairment of function occurs that does not warrant interruption of testing to develop a fix must also be included in the list of endurance test frequencies.

2.3.2 Frequencies Where Response Prominences Have Been Identified.

Components may contain many parts and subassemblies that can resonate. Some components may have nonlinear characteristics such as clearances between parts or equipment mounted on isolation mounts. Therefore, the amplitude of excitation may be important relative to identifying response prominences for these components. Input amplitude dependent response prominences may potentially be the same overall resonance rather than different ones. In light of this potential, unusual test results, such as uncovering response prominences during variable frequency testing that were not uncovered during exploratory testing, need to be thoroughly investigated to not only try and determine the cause of the response prominence but to ascertain whether the response prominence is unique or part of another response prominence. Criteria for selecting response prominences for endurance testing are as follows:

- a. A transmissibility greater than 1.5 at any measurement location is sufficient to classify a maximum as a response prominence, and include the corresponding frequency in the list of endurance test frequencies. However, the converse is not necessarily true, i.e., a response prominence whose transmissibility is less than 1.5 cannot be excluded solely on the magnitude of the transmissibility. Possible explanations as to why transmissibility maxima of magnitudes less than 1.5 may still represent real response prominences are:
 - (1) The transducer may not be at the point of maximum response. If probing or some other means cannot be employed to locate the point of maximum response (e.g., due to inaccessibility), then all maxima displaying the classic characteristics of a resonance that cannot be attributed to instrumentation or numerical error must be identified as response prominences, and their frequencies included in the list of endurance test frequencies.
 - (2) The transducer may be at or near a response node point (location of minimal or low response in a vibration mode) at that frequency. The location of node points (as well as the locations of maximum response) can change location as changes in the drive frequency excite different modes of vibration.
 - (3) The mass of the part and the amplitude of vibration of the mass that is in maximum response are not large enough to generate the forces necessary to cause structural responses of large enough magnitude at the location of the transducer.
 - (4) The driving frequency is not exactly at the resonant frequency, thus the peak response is not obtained.
- b. Without further investigation, the existence of a response prominence for the remaining maxima cannot be confirmed, nor the possibility of the existence of a response prominence excluded. If practical, an attempt should be made to obtain further information to resolve this issue by probing for the maximum response location with movable transducers, listening, visually locating or feeling for the maximum response points.
- c. If it can be shown that response prominences uncovered do not compromise equipment structural/functional integrity, these response prominences do not have to be included in the endurance test. Justification should be provided in the test report as to why these response prominences have been excluded from endurance testing.

MIL-STD-810H
METHOD 528.1 ANNEX A

2.4 Guidance for Specifiers.

Carefully determine all functions of the equipment that must be preserved under normal shipboard vibration. Determine the functional requirements that must be met during the vibration tests including the appropriate test acceptance criteria and include them in the procurement documents. A careful and thorough evaluation of the functional requirements will significantly reduce the potential for problems, define the basis for instrumentation selection and placement, and help in the interpretation of test results.

If possible, determine how and where to instrument the test item based on the functional requirements and expected responses, or consider requiring the vendor to make this determination. If an area of concern cannot be directly instrumented, consider instrumenting to find alternate manifestations of this area of concern (e.g., voltage fluctuations, pressure variations, noise, and contact closures). While analyses of the test and test equipment (if performed) can provide insights into possible test responses of some equipment, often neither extensive nor complicated analyses are needed, and common sense alone can often be used to establish reasonable locations of instrumentation if the functional requirements are well known. If the test vendor will determine the instrumentation scheme, depending on the equipment, consider requesting the instrumentation scheme for information or approval.

Depending on the equipment, consider requiring prior approval of frequencies used for endurance testing.

MIL-STD-810H
METHOD 528.1 ANNEX A

(This page is intentionally blank.)

MIL-STD-810H
METHOD 528.1 ANNEX B**METHOD 528.1, ANNEX B****NOTES AND ENGINEERING GUIDANCE**

(This Annex contains information of a general or explanatory nature that may be helpful, but is not mandatory.)

1. INTENDED USE.

- a. This Method is used to qualify shipboard equipment for the environmental vibrations and internally excited vibrations encountered during operation of the equipment aboard ship.
- b. In some special machinery, equipment, or installations (such as antennae, large machinery items, and certain unique designs), it may be necessary to deviate from this Method.
- c. Type I vibration testing is intended to qualify new equipment for exposure to shipboard vibrations during the lifetime of the ship (approximately 30 years).
- d. The primary purpose of Type I vibration testing is to prove the physical and functional integrity of equipment when subject to a prescribed steady-state vibration environment. The results of the application of this Method do not provide a definitive determination of the test item's natural frequencies and mode shapes.
- e. This Method does not cover vibrations associated with reciprocating machinery, or those associated with propulsion and shafting. For these types, see MIL-STD-167-2A.
- f. The primary purpose of the application of this Method to Type II vibrations is from the standpoint of mechanical suitability, and not from a structure-borne noise standpoint. See MIL-STD-740-2 for noise suitability of equipment.

2. ACQUISITION REQUIREMENTS.

Acquisition documents should specify the following:

- a. Title, number, and date of the method.
- b. Reporting requirements, including requirements for Notification of Test, Equipment Test Plan, and/or Test Report (see paragraphs 4.1, 5.1.2.5.1, and 5.1.2.5.2 in the front part of this Method).
- c. Identification of component compliance on component drawing, in Test Report, or on label plate (see paragraph 4.2).
- d. Disposition of tested equipment and related equipment (see paragraph 4.3 in the front part of this Method).
- e. Type(s) of vibration required (see paragraphs 5.1 and 5.2 in the front part of this Method).
- f. Type I:
 - (1) How the equipment will be operated after the test to demonstrate the machinery or equipment has no damage from the test, including acceptable operational degradations (see paragraphs 5.1.1 and 5.1.2.4.1 in the front part of this Method).
 - (2) Whether the test engineer needs concurrence of the procuring agency for determination of major vs. minor failures before continuing testing (see paragraph 5.1.1 in the front part of this Method).
 - (3) Whether measurement transducer locations need to be approved by the procuring agency for Type I testing (see paragraph 5.1.2.2) in the front part of this Method).
 - (4) Methods of mounting equipment for test (see paragraph 5.1.2.3.4 in the front part of this Method).
 - (5) Whether internal mounts should be installed for all, a specific part, or none of the test (see paragraph 5.1.2.3.5 in the front part of this Method).
 - (6) How the test item will be energized or operated during Type I vibration tests (e.g., pressure, flow rate, voltage current, and cycling of principal functions during testing), including acceptable operational degradations (see paragraphs 5.1.1 and 5.1.2.4.1 in the front part of this Method).
 - (7) When required, the maximum test frequencies (see paragraph 5.1.2.4.4 in the front part of this Method)

MIL-STD-810H
METHOD 528.1 ANNEX B

- (8) Alternative test amplitudes (see paragraph 5.1.2.4.5 in the front part of this Method).
- (9) Whether approval is required for selection of frequencies used for endurance testing (see paragraphs 5.1.2.4.6 and 5.1.2.4.7 in the front part of this Method).
- (10) The acceptance authority for the test report and any other approval items (see paragraphs 5.1.2.5.1 and 5.1.2.5.2 in the front part of this Method).

g. Type II:

- (1) Special vibration and balance requirements (see paragraph 5.2 in the front part of this Method).
- (2) Whether dynamic balance is required for machinery rated at lower than 150 rpm (see paragraph 5.2.2.1 in the front part of this Method).
- (3) Balance quality grade (see paragraph 5.2.2.2 in the front part of this Method).
- (4) Whether vibration acceptance criteria of Figure 528.1B-2 are specified for equipment with rigid rotors (see paragraph 5.2.2.2 in the front part of this Method).
- (5) When required, methods of mounting test items for test (see paragraph 5.2.3.2.1 in the front part of this Method).

3. ASSOCIATED DATA ITEM DESCRIPTIONS (DIDs).

This Method has been assigned an Acquisition Management Systems Control (AMSC) number authorizing it as the source document for the following DIDs. When it is necessary to obtain the data, the applicable DIDs must be listed on the Contract Data Requirements List (DD Form 1423).

<u>DID Number</u>	<u>DID Title</u>
DI-ENVR-81647	Mechanical Vibrations of Shipboard Equipment Measurement Test Plan and Report
DI-MISC-81624	Notification of Test/Trials

4. TAILORING GUIDANCE FOR CONTRACTUAL APPLICATION.

Note: Equipment installed aboard Naval ships is subjected to varying frequencies and amplitudes of environmental vibration for extended periods of time, during which they are required to perform their normal function. Principal causes of steady state shipboard vibration are propeller blade excitation and unbalanced forces of the propeller and shafting. Vibrations are also experienced by shipboard mounted equipment caused by mounting system resonances, changes in ship speed and heading, and changes in sea state. Vibration magnitudes measured on a ship during vibration trials should not be compared with the magnitudes shown in Table 528.1-I because ship vibration trials are conducted in quiet water to achieve repeatable results during which changes in speed and heading are not made. See ANSI S2.25 for additional tailoring guidance.

- a. The frequency range for Type I vibrations is determined based on blade rate frequencies associated with a specific ship design. If equipment is to be tested for use on multiple ship classes, the equipment may be tested over the frequency range encompassing various ship classes as required.
- b. For Type I testing, if equipment is to be tested for use on multiple ship classes, the choice of equipment mounting may affect the number of tests required to qualify the equipment for use on the intended ships.

5. SUPERSEDING DATA.

This Method covers Types I and II vibration requirements formerly covered in MIL-STD-167-1 & 1A (SHIPS). Types III, IV, and V requirements are covered in MIL-STD-167-2A (SH).

MIL-STD-810H
METHOD 528.1 ANNEX B

6. GUIDANCE DOCUMENTS.

Table 528.1B-I lists documents that provide design guidance and definitions in the field of vibration.

Table 528.1B-I. Related documents.

AMERICAN NATIONAL STANDARDS INSTITUTE (ANSI)	
S1.1	- Acoustical Terminology
S2.4	- 1990, American Standard Methods for the Specifying of Characteristics of Auxiliary Analog Equipment for Shock and Vibration
S2.5	- 1990, American Standard Methods for Specifying the Performance of Vibration Machines
S2.7	- 1990, American Standard Terminology for Balancing Rotating Machinery
S2.19	- Mechanical Vibration – Balance Quality Requirements of Rigid Rotors, Part 1: Determination of Permissible Residual Unbalance, Including Marine Applications
S2.25	- Guide for the Measurement, Reporting, and Evaluation, of Hull and Superstructure Vibration in Ships
INTERNATIONAL STANDARDS ORGANIZATION (ISO)	
1940/1	- 1986, Mechanical Vibration – Balance Quality Requirements of Rigid Rotors – Part 1: Determination of Permissible Residual Unbalance
DEPARTMENT OF DEFENSE	
<u>SPECIFICATIONS</u>	
MIL-M-17185	- Mounts, Resilient; General Specifications and Tests for (Shipboard Application)
<u>STANDARDS</u>	
MIL-STD-740-2	- Structureborne Noise Measurements and Acceptance Criteria of Shipboard Equipment
<u>NAVAL SEA SYSTEMS COMMAND (NAVSEA) PUBLICATIONS</u>	
NAVSHIPS 94323	- Maintainability Design Criteria Handbook for Design of Shipboard Electronic Equipment
NAVSHIPS 0967-316-8010	- BUSHIPS Reliability Design Handbook (Electronics)
NAVSHIPS 0967-309-3010	- Design of Shock and Vibration Resistant Electronic Equipment for Shipboard Use
NAVSEA 0900-LP-090-3010	- Guideline to Military Standard MIL-STD-167-1 (SHIPS) Mechanical Vibrations of Shipboard Equipment, December 1993
SVM-18	- Shock and Vibration Design Manual, Naval Sea Systems Command, April 2001

MIL-STD-810H
METHOD 528.1 ANNEX B

(This page is intentionally blank.)

MIL-STD-810H
PART THREE

PART THREE – WORLD CLIMATIC REGIONS – GUIDANCE

<u>Paragraph</u>	<u>Page</u>
SECTION I – INTRODUCTION.....	PART THREE-1
1. SCOPE.....	PART THREE-1
1.1 Purpose	PART THREE-1
1.2 Part Three Organization.....	PART THREE-1
1.3 Application	PART THREE-1
1.4 General Guidance	PART THREE-2
1.5 Limitations (AR 70-38)	PART THREE-2
SECTION II – DISTRIBUTION OF CLIMATIC DESIGN TYPES.....	PART THREE-3
2. DISTRIBUTION OF CLIMATIC DESIGN TYPES.....	PART THREE-3
2.1 Hot climatic design type (A1 and B3)	PART THREE-3
2.2 Basic climatic design type	PART THREE-3
2.3 Cold and severe cold design types	PART THREE-4
2.4 Absolute maximum and minimum temperatures	PART THREE-4
SECTION III – NATURAL AND INDUCED ENVIRONMENT – VARIOUS ELEMENTS...PART THREE-8	
3. NATURAL AND INDUCED ENVIRONMENT AND ASSOCIATED ELEMENTS	PART THREE-8
3.1 Frequency of occurrence.....	PART THREE-8
3.2 Worldwide surface environment (summary of daily cycles)	PART THREE-8
3.2.1 Acceptable materiel operation	PART THREE-8
3.2.2 Climatic testing.....	PART THREE-9
3.2.3 Laboratory climatic tests.....	PART THREE-9
3.2.4 Accelerated and aggravated tests	PART THREE-9
4. ENVIRONMENT ELEMENTS – Climatic Design Types – Natural and Induced.PART THREE-10	
4.1 Hot climatic design types.....	PART THREE-10
4.1.1 High temperature	PART THREE-11
4.1.1.1 Hot-dry cycle (A1).....	PART THREE-11
4.1.1.2 High temperature with low relative humidity	PART THREE-12
4.1.2 High temperature with high humidity	PART THREE-14
4.1.3 High absolute humidity.....	PART THREE-15
4.1.3.1 Hot-humid cycle (B3)	PART THREE-15
4.2 Basic climatic design type	PART THREE-16
4.2.1 High relative humidity with high temperature	PART THREE-16
4.2.2 High humidity daily cycles	PART THREE-17
4.2.3 Temperature, humidity, solar radiation (constant high humidity cycle (B1)).....	PART THREE-18
4.2.4 Temperature, humidity, solar radiation (variable high humidity cycle (B2))	PART THREE-18
4.2.5 Basic hot daily cycle (A2)... ..	PART THREE-19
4.2.6 Basic cold daily cycle (C1).....	PART THREE-20
4.3 Cold and severe cold design types	PART THREE-21
4.3.1 Low temperature	PART THREE-21
4.3.2 Cold climate design type (C2)	PART THREE-23
4.3.3 Severe cold climatic design type (C3)	PART THREE-24
4.3.4 High relative humidity with low temperature	PART THREE-24
4.3.5 Low relative humidity with low temperature.....	PART THREE-24
4.3.6 Low absolute humidity	PART THREE-24

MIL-STD-810H
PART THREE

CONTENTS - Continued

<u>Paragraph</u>		<u>Page</u>
5.	ADDITIONAL ENVIRONMENTAL ELEMENTS.....	PART THREE-25
5.1	Wind.....	PART THREE-25
5.1.1	Wind element.....	PART THREE-25
5.1.2	Wind speed.....	PART THREE-25
5.2	Rain.....	PART THREE-27
5.2.1	Intensities.....	PART THREE-27
5.2.2	Rainfall rate.....	PART THREE-28
5.3	Snow.....	PART THREE-29
5.4	Ice.....	PART THREE-32
5.4.1	Ice phenomena.....	PART THREE-32
5.4.2	Ice accretion.....	PART THREE-33
5.5	Atmospheric pressure.....	PART THREE-33
5.6	Ozone concentration.....	PART THREE-33
5.7	Sand and dust.....	PART THREE-33
5.8	Dust as a natural obscurant.....	PART THREE-34
5.9	Freeze-thaw cycles.....	PART THREE-36
5.9.1	Basic cold-wet cycle.....	PART THREE-36
5.10	Microbial growth (fungus/mould).....	PART THREE-37
5.11	Hail.....	PART THREE-38
5.12	Combined environmental effects.....	PART THREE-38
5.13	High elevations and upper air conditions.....	PART THREE-39
6.	REFERENCED/RELATED DOCUMENTS.....	PART THREE-39
6.1	Reference documents.....	PART THREE-39
6.2	Related documents.....	PART THREE-39

FIGURES

Figure 1.	Areas of occurrence of climatic design types.....	PART THREE-5
Figure 2.	Distribution of absolute minimum temperatures.....	PART THREE-6
Figure 3.	Distribution of absolute maximum temperatures.....	PART THREE-7

TABLES

Table I.	Summary of climatic conditions and daily cycles of temperature, solar radiation, and RH.....	PART THREE-10
Table II.	Hot climatic design type A1: Hot-dry daily cycle (Natural and Induced).....	PART THREE-13
Table III.	Daily cycle of temperature & other elements associated with worldwide long-term extremes of high temperature.....	PART THREE-14
Table IV.	Abadan frequencies of occurrence of high temperatures with high humidity.....	PART THREE-15
Table V.	Hot climate design type B3: Hot-humid daily cycle.....	PART THREE-16
Table VI.	Basic climatic design type B1: Constant high humidity daily cycle.....	PART THREE-18
Table VII.	Basic climatic design type B2: Variable high humidity daily cycle.....	PART THREE-19
Table VIII.	Basic climatic design type A2: Basic hot daily cycle.....	PART THREE-20
Table IX.	Basic climatic design type C1: Cold daily cycle.....	PART THREE-21

MIL-STD-810H
PART THREE

CONTENTS - Continued

<u>Paragraph</u>	<u>Page</u>
Table X. Monthly cycle of temperature associated with the worldwide long term low temperature extremes.....	PART THREE-22
Table XI. Cold climate design type C2: Daily cycle	PART THREE-23
Table XII. Wind speed multiplication factors at selected heights.....	PART THREE-25
Table XIII. Associated gusts (m/s).....	PART THREE-26
Table XIV. Associated gusts, m/s (mph).....	PART THREE-27
Table XV. Rainfall intensities – Drop diameter range	PART THREE-27
Table XVI. Raindrop concentrations per cubic meter	PART THREE-29
Table XVII. Long term extreme rainfall rates (cm/h).....	PART THREE-29
Table XVIII. Horizontal mass fluxes for blowing snow	PART THREE-30
Table XIX. Typical distribution of blowing snow particle sizes	PART THREE-30
Table XX. Highest recorded snow mass fluxes.....	PART THREE-32
Table XXI. Number of days per year with dust storms (visibility <1 km).....	PART THREE-35
Table XXII. Cold-wet daily cycle of temperature, humidity, and solar radiation.....	PART THREE-37
Table XXIII. European test fungus species.....	PART THREE-38
Table XXIV. Low air pressure and temperature at elevation	PART THREE-39

PART THREE ANNEX A. WEATHER AND CLIMATIC EXTREMES – A BRIEF SUMMARY

1.	INTRODUCTION	PART THREE-A-1
2.	MIL-HDBK-310	PART THREE-A-1

ANNEX A FIGURES

Figure A-1. Temperature extremes.....	PART THREE-A-3
Figure A-2. Precipitation extremes.....	PART THREE-A-6
Figure A-3. Miscellaneous extremes	PART THREE-A-8

ANNEX A TABLES

Table A-I. Weather Conditions & Climatic Extremes – Brief Summary	PART THREE-A-1
Table A-II. Precipitation extremes.....	PART THREE-A-4
Table A-III. Miscellaneous extremes	PART THREE-A-7

PART THREE ANNEX B. TERMINOLOGY

1.	TERMS	PART THREE-B-1
1.1	Climatic design types.....	PART THREE-B-1
1.2	Daily weather cycles	PART THREE-B-1
1.3	Operational, and storage and transit conditions	PART THREE-B-1

PART THREE ANNEX C. COMPARISON OF AR 70-38 WITH MIL-HDBK-310

1.	RELATIONSHIP BETWEEN AR 70-38 AND MIL-HDBK-310	PART THREE-C-1
1.1	Background	PART THREE-C-1
1.2	Risk policy	PART THREE-C-2
1.3	Additional guidance	PART THREE-C-2

MIL-STD-810H
PART THREE

(This page is intentionally blank.)

MIL-STD-810H
PART THREE

This Part has been extracted in whole or in part from Army Regulation (AR) 70-38, "Research, Development, Test and Evaluation of Materiel for Extreme Climatic Conditions," from the Environmental Standards for Materiel Design Group of the AirLand Battlefield Environment Executive (ALBE) Committee (1987), "Environmental Factors and Standards for Atmospheric Obscurants, Climate, and Terrain," Washington, D.C., and MIL-HDBK-310, "Global Climatic Data for Developing Military Products," and modified to fit the format of this document. Although originally prepared for Army and DoD applications, the included data (unless otherwise noted), coincide with NATO STANAG 4370, AECTP 230.

PART THREE – WORLD CLIMATIC REGIONS – GUIDANCE
SECTION I - INTRODUCTION

1. SCOPE.

1.1 Purpose.

This document provides planning guidance for realistic consideration (starting points) of climatic conditions in the research, development, test, and evaluation (RDTE) of materiel and materials used throughout their life cycles in various climatic regions throughout the world. It is intended that this and related documents will help achieve the objective of developing materiel that will perform adequately under the environmental conditions likely to be found throughout its life cycle in the areas of intended use.

1.2 Part Three Organization.

Part Three has been structured such that it follows the logical sequence of events leading to an environmental test program.

- a. Section I - Introduction.
- b. Section II – Distribution of the Climatic Design Types.
- c. Section III – Natural and Induced Environment - Various Elements.
- d. Section IV - Referenced and Related Documents.
- e. Annex A - Weather and climatic extremes.
- f. Annex B - Discussion of Terminology Used in this Part.
- g. Annex C - Comparison of AR 70-38 with MIL-HDBK-310.

1.3 Application.

1.3.1 The climatic data included in this Part apply to essentially all areas of potential use for materiel in all parts of the world except the Antarctic continent (excluded by treaty). These data represent free air (ambient) conditions, and are not to be confused with the response of materiel, either to these conditions, or to those of a platform on or within which the materiel may be located. The selection of climatic environments for testing should be that which gives satisfactory results most economically, considering the extent of deployment in each area of potential use, the current technology level, and the time required for development. For example, if certain materiel is to be used only in areas where cold conditions prevail, materiel should be designed solely for the conditions of those areas. The guidance for following realistic natural environments is provided as a basis for developing design requirements and determining appropriate test conditions:

- a. Climate (temperature, humidity, solar radiation, rain, snow, wind, blowing sand, dust and snow, icing phenomena, ozone, freeze-thaw occurrences, fog, cloud ceiling heights, and visibility).
- b. Weather-related atmospheric obscurants (rain, snow, fog, cloud cover).
- c. Induced climatic conditions (storage and transit).

1.3.2 The general climatic design values in paragraphs 3 and 4 and their sub-paragraphs represent a conservative design approach; i.e., there is little risk that the climatic design values will be exceeded in the areas to which they apply. Because there is some risk, the design values should be modified for some materiel items. In certain cases, failure of an item may be so critical that more severe climatic criteria should be applied to ensure against environment-related failure. In other cases, the consequences of failure may be slight, so the cost of designing to the given values may be unwarranted. Special study may be required in these cases to determine the most appropriate design values. The type of failure is also an important consideration. Two categories of failure that may cause different design decisions are identified as follows:

MIL-STD-810H
PART THREE

- a. **Reversible failure.** For the duration of climatic extremes, the materiel may continue to function, but its performance or safety is reduced, or it may cease to function. When the extreme climatic conditions cease, the materiel will return to normal operation.
- b. **Irreversible failure.** The materiel suffers a failure during climatic stress that is so damaging that it will not return to normal operation when the extreme climatic conditions cease.

1.4 General Guidance.

1.4.1 Thoroughly explore the anticipated life cycles, including periods of transportation, storage, and use. For specific systems, detail these periods in a Life Cycle Environmental Profile (LCEP) that will guide materiel development and testing activities.

1.4.2 Because climatic requirements can have a substantial impact on acquisition and support costs, consider designing, developing, and testing materiel to operate under conditions less severe (e.g., 1 percent high temperature values) than the absolute extremes that may occur within the areas of intended use. This implies there is some risk of failure to operate at times. (See paragraph 6.2 for discussion of risk levels.) The four climatic design types outlined in paragraph 2 all contain some element of risk.

1.4.3 Fully and creatively exploit testing in climatic chambers before testing in the natural environment (unless such testing is impractical, e.g., physical limitations, mobility requirements, soldier/system requirements, etc.), to determine basic problems that can occur before natural environment tests are conducted. Test results from climatic chambers, however, cannot be interpreted as a total substitute for tests conducted in natural environments because, among other things, they do not reproduce all of the interacting factors or synergies associated with the natural environment, concurrently. Both chamber tests and field (natural) tests serve useful purposes. Normally, chamber tests should not be substituted for natural environment tests; chamber tests attempt to replicate the effects of the environment and not the environment itself.

1.4.4 Select sites for field testing, if possible, to induce representative deterioration rates and performance challenges from all environmental effects that the materiel will be expected to encounter throughout its life cycle. Plan the natural environment exposure to coincide with the respective climatic extremes. When time and funding constraints permit, select sites with the highest materiel deterioration rates or most severe conditions.

1.4.5 Consider the interaction of materiel with the environment in all phases of RDTE because the induced conditions may be quite different from those of the natural environment. Design sheltered materiel to operate under the conditions within the shelter during operation in the stipulated areas. This includes storage conditions within the shelter without environmental control, and operational conditions with environmental control. Design sheltered materiel to withstand environmental effects that occur during unsheltered storage and transit.

1.4.6 Design potentially dangerous items (e.g., ammunition and explosives) to meet safety requirements for all climatic design values despite their chance of being used or the requirement to operate in those climates. An item developed for the basic climatic design type may fail in the more severe climatic conditions of the hot, cold, or severe cold types and, in some cases, produce catastrophic or extremely hazardous results.

1.5 Limitations. (AR 70-38)

The climatic information in paragraph 2 and its subparagraphs should not be used if:

- a. In the RDTE of materiel to be used at a specific place or in a known limited area. This materiel should be designed to withstand climatic conditions at the specific place. In these situations, the climatic requirements should be outlined by the combat user in a special study prepared by designated environmental specialists.
- b. In the RDTE of materiel that has inherent limitations, such as food items or medical supplies that must always be kept in controlled environments. Also excluded are most individual clothing items that, by themselves, are not capable of protecting the soldier from a wide range of climatic conditions. The total range of climatic conditions cited in paragraph 2, however, can and should be used as the guide for developing the required number of clothing ensembles to protect personnel against all conditions they may encounter.

MIL-STD-810H
PART THREE

SECTION II – DISTRIBUTION OF CLIMATIC DESIGN TYPES

2. DISTRIBUTION OF CLIMATIC DESIGN TYPES.

There are four climatic design types: Hot (A1 and B3), Basic (A2, B1, B2, and C1), Cold (C2), and Severe Cold (C3). Figure 1 shows land areas where the four climatic design types apply. Discussion of the delimitation of the climatic conditions (paragraph 2.2) is included to permit proper interpretation and use of the map. The primary basis for delimiting the climatic conditions is temperature; secondary consideration is given to humidity conditions.

2.1 Hot climatic design type (A1 and B3).

The areas where hot conditions apply include most of the low latitude deserts of the world. During summer in these areas, temperatures above 43°C (110°F) occur frequently, but except for a few specific localities, temperatures will seldom be above 49°C (120°F). In winter, temperatures are not likely to be extremely low so that the low temperatures of the basic climatic design type apply. If materiel is designed only for the hot type, a special recommendation for low temperature design values should be sought. Limited portions of this area are sometimes subject to very high absolute humidity, although the highest temperatures and highest dewpoints do not occur at the same time.

The world's highest air temperatures occur in the areas identified with the hot climatic design type in Figure 1. This area is hotter than the basic design type with a 1-percent temperature of 49°C (120°F) in the hottest parts. These are primarily low latitude deserts that, in addition to very high air temperatures, concurrently experience very low relative humidity (except in the hot humid areas) and intense solar radiation. Two daily cycles, described in paragraphs 4.1.1.1 and 4.1.3.1 make up the hot design type. They are:

- a. A1 Hot-dry (paragraph. (Paragraph 4.1.1.1)
- b. B3 Hot-humid. (Paragraph 4.1.3.1)

2.2 Basic climatic design type.

The area this type applies to includes the most densely populated and heavily industrialized parts of the world as well as the humid tropics. The entire range of basic design conditions does not necessarily apply to any one place. Each single design condition (high temperature, low temperature, and high humidity) applies to a widespread area. When taken together, the design values should provide for satisfactory materiel throughout the area involved. Tropical areas are included in the basic climatic design type because the temperature of the humid tropics is quite moderate, and the humidity is also experienced in the midlatitudes. The unique feature of the tropics that makes it important to materiel is the persistence of high humidity over long periods of time. This condition not only promotes corrosion but is an excellent environment for insect and microbiological damage.

The Basic is by far the largest of the four climatic design types. However, this large area has one constant characteristic: it has no extremely hot or cold conditions. Nevertheless, non-temperature dependent design problems within the Basic Design Type can vary with the magnitude and persistence of humidity conditions. The basic area has 1-percent cold and hot temperatures of -31.7°C (-25°F) and 43.3°C (110°F) during the worst month in the coldest and hottest parts of the regional type, respectively. The Humid Tropics are largely confined to areas between the Tropics of Capricorn and Cancer, whereas other areas of the Basic Design Type (Basic Hot & Basic Cold) range from the Tropics to the polar regions. These other areas include most of the densely populated, industrialized, and agriculturally productive land of the world.

The humid tropics and the midlatitudes (basic design type) are characterized by temperatures more moderate than the extremes of the other design types. Areas where the basic type applies are more widespread than the hot and cold design types combined. They also include most of the densely populated, highly industrialized sectors of the world. Because microbial deterioration is a function of temperature and humidity and is an inseparable condition of hot humid tropics and the mid-latitudes, consider microbial deterioration in the design of all standard general-purpose materiel. Four daily cycles, described as shown below are recognized for the basic design types. They are:

- a. (B1) Constant high humidity (paragraph 4.2.3).
- b. (B2) Variable high humidity (paragraph 4.2.4).
- c. (A2) Basic hot (paragraph 4.2.5)
- d. (C1) Basic cold (paragraph 4.2.6)

MIL-STD-810H
PART THREE

2.3 Cold and severe cold design types.

The areas designated as cold, and severe cold, primarily northern North America, Greenland, northern Asia, and the Tibetan Highlands of China, were delimited because of the occurrence of low temperatures. In the area of the cold design type, temperature during the coldest month in a normal year may be colder than the basic cold extreme of -32°C (-25°F). In the severe cold areas, temperature during the coldest month in a normal year may be colder than the cold extreme of -46°C (-50°F), but colder than -51°C (-60°F) no more than 20 percent of the hours in the coldest month in the coldest part of the area (such as northern Siberia where absolute minimum temperatures as low as -68°C (-90°F) have been recorded). Because the extreme low temperatures are not controlled by a daily solar cycle, they persist for a long enough period of time for materiel to reach equilibrium at a temperature near the minimum.

The cold climatic design type areas in Figure 1 that are confined to the Northern Hemisphere have temperatures much lower than the basic cold areas, but not as low as the severe cold areas. It has a 1 percent temperature of -45.6°C (-50°F) in the coldest parts. The cold cycle is described in paragraphs 4.2.6 - 4.3.2.

The severe cold climatic design type areas in Figure 1 have the lowest temperatures on the surface of the earth, except for Antarctica (that is not considered in this document). It has a 20-percent temperature of -51°C (-60°F) in the coldest parts. These low temperatures are found in the northern continental interiors and the Arctic. The severe cold condition is described in paragraph 4.3.3.

2.4 Absolute maximum and minimum temperatures.

Figures 2 and 3 are included to show the absolute maximum and minimum temperatures that have been observed. The maps are generalized because of data limitations, and the uneven occurrence of extremes.

MIL-STD-810H
PART THREE

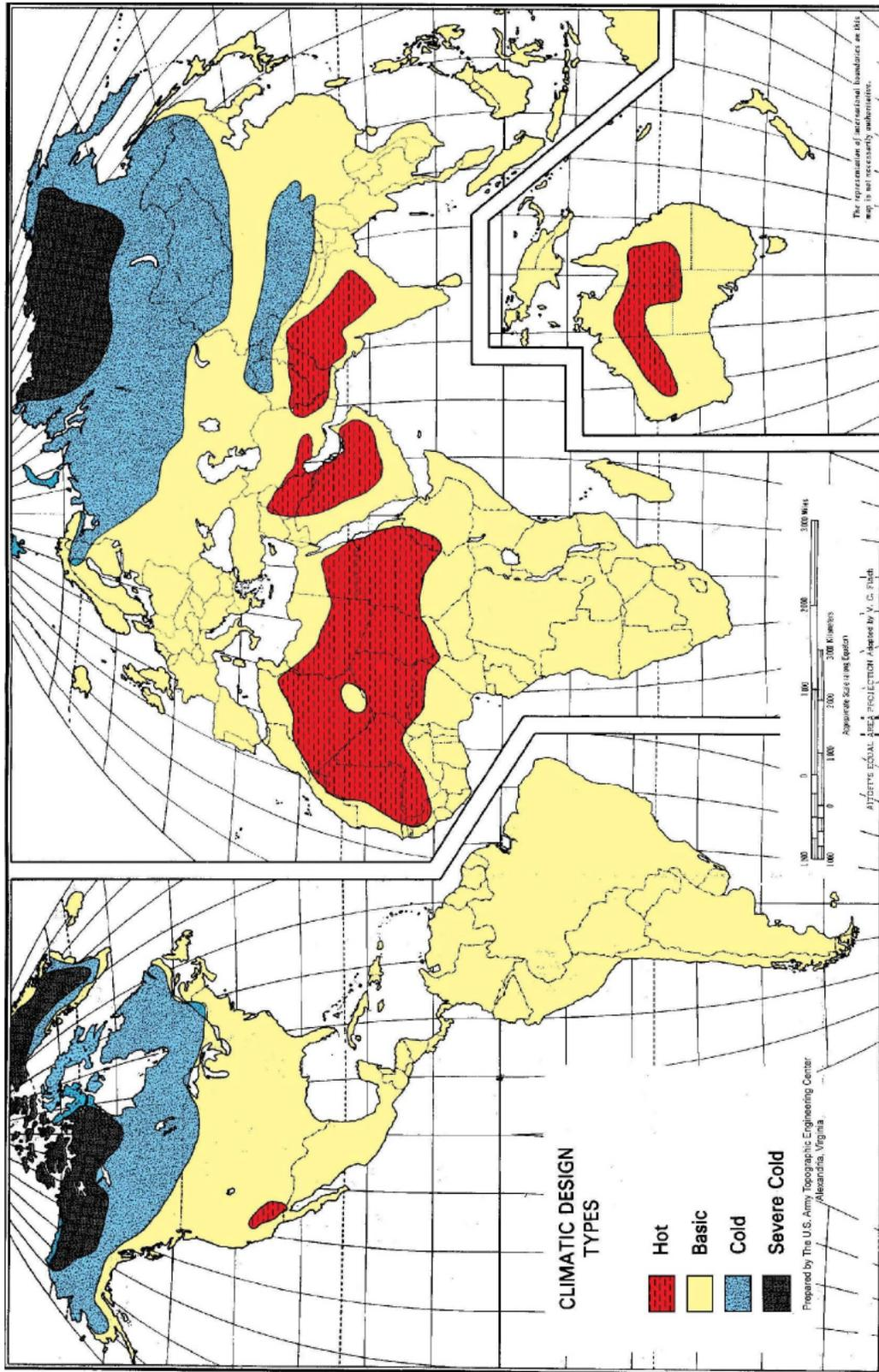


Figure 1. Areas of occurrence of climatic design types.

MIL-STD-810H
PART THREE

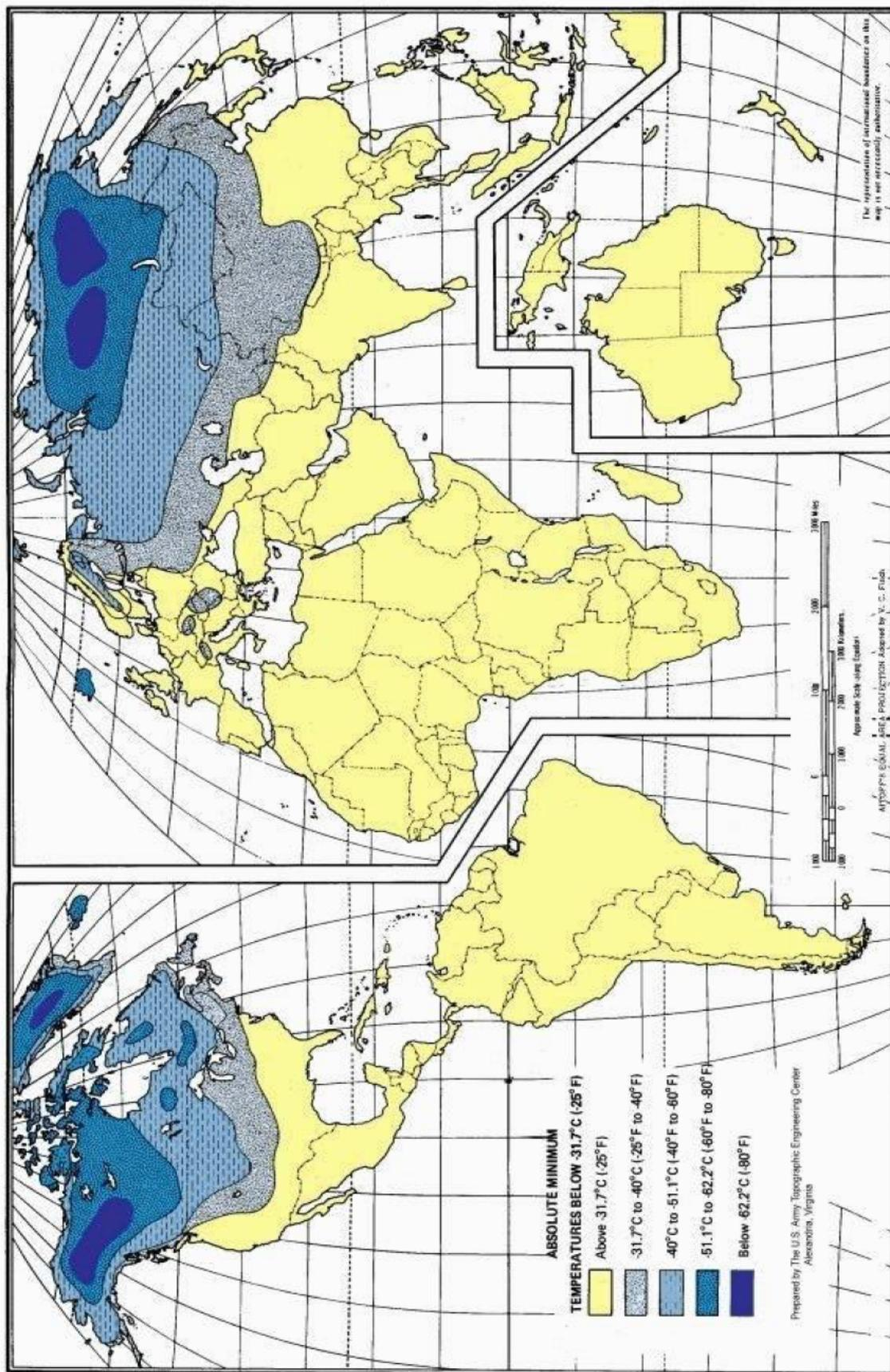


Figure 2. Distribution of absolute minimum temperatures.

MIL-STD-810H
PART THREE

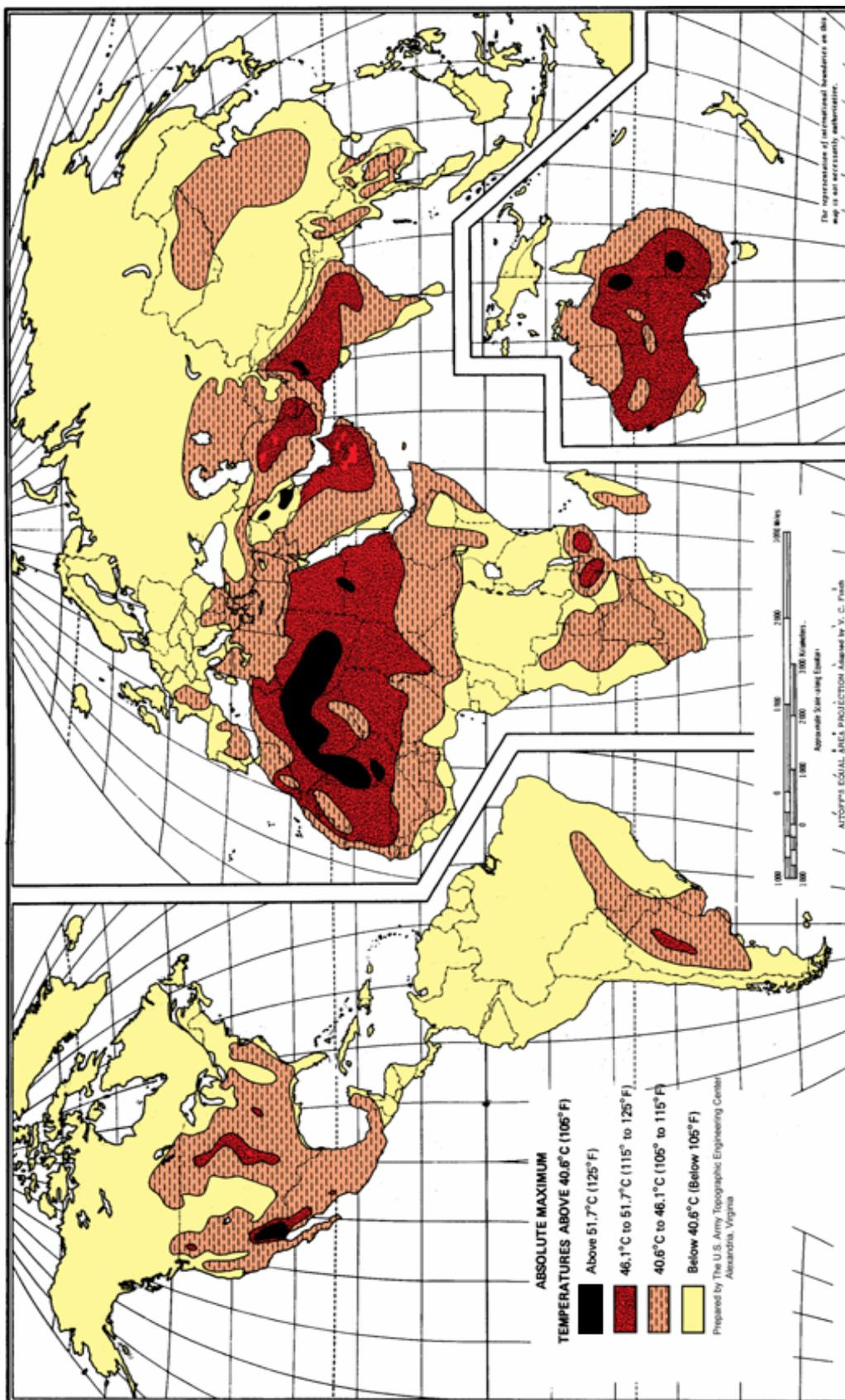


Figure 3. Distribution of absolute maximum temperatures.

MIL-STD-810H
PART THREE

SECTION III – NATURAL AND INDUCED ENVIRONMENT - VARIOUS ELEMENTS

3. NATURAL AND INDUCED ENVIRONMENT AND ASSOCIATED ELEMENTS.

NOTE: Annex A contains a list of naturally-occurring “Weather and Climatic Extremes.”

Although climatic conditions during a field test are not likely to be as extreme as the values specified in paragraph 4 and its subparagraphs, there are distinct advantages to conducting tests in real world environments where the combined effects of several climatic factors can cause difficulties not revealed by chamber testing. On the other hand, if natural field environment tests are conducted under conditions that are less extreme than those called for by the system LCEP and requirements documents, additional laboratory tests may be required - particularly when natural field test results are marginal. Data describing climatic conditions prevailing during natural field tests should be recorded at the test site, and documented in the final report to provide a basis for future evaluation.

3.1 Frequency of occurrence.

Examples are:

- a. For both worldwide and regional applications, the frequency of occurrence of climatic elements (e.g., temperature) is based on hourly data wherever possible. From hourly data it is possible to determine the total number of hours a specific value of a climatic element is equaled or exceeded. For example, if a temperature occurs, or is exceeded for an average of 7 hours in a 31-day month (744 hours), it has occurred roughly 1 percent of the hours in that month; if it is exceeded an average of 74 hours in the month, it has a frequency-of-occurrence of 10 percent, etc. The value that is equaled or exceeded 1 percent of the time is referred to as the “1-percent value.”
- b. Long-term climatic extremes are values that are expected to occur at least once, for a short duration (≤ 3 hours), during approximately 10, 30, and 60 years of exposure. Therefore, they are rarer climatic events than the 1-percent values.
- c. Values occurring for specified frequencies-of-occurrence during the worst month may also occur in other months, but with lower frequency-of-occurrence.

3.2 Worldwide surface environment. (Summary of daily cycles) (Paragraph 6.1, reference a, paragraph 5.1.)

Figure 1 provides a general guide as to the location of the four climatic design types described in Table 1. However anomalies may exist within the areas shown, so the LCEP should always be referenced. Table I is a summary table of the daily extremes (highest and lowest values in a 24-hour cycle) of temperature, solar radiation, and relative humidity for the eight daily cycles cited in this document. Details of each cycle, and other atmospheric elements (hydrometeors, wind, blowing sand, blowing dust, ozone, and atmospheric pressure) are given in paragraphs 4 and 5 and their subparagraphs. In most cases, extremes of these other elements do not occur at the same time as the extremes of temperature or humidity. However, with certain severe cold and cold phenomena, two or more elements may occur at the same time, e.g., ice, fog, and low temperatures.

3.2.1 Acceptable materiel operation.

In general, design materiel to operate during all but a small percentage of the time. Once an acceptable frequency-of-occurrence of a climatic element has been determined, the corresponding climatic value can be ascertained from the available climatic data. Recommend a 1 percent frequency be initially considered for all climatic elements except severe cold temperature, for which a 20 percent frequency is recommended, and rainfall for which a 0.5 percent frequency is recommended.

Consider more extreme climatic values (storage/transit environment and highest/lowest recorded) for materiel whose failure to operate is life-threatening, or for materiel that could be rendered useless or dangerous after a one-time exposure. For such materiel, long-term climatic extremes, or the record extreme, would be more appropriate for design of materiel that is not protected from the environment. Note that highest/lowest recorded extremes depend upon the period of record (POR) and should not be construed as “all time” extremes. The use of these more extreme values, instead of those occurring for a percent of the time during the most severe month each year, should be determined by the agency or department responsible for development. An option for such materiel would be protection from the exposure to these extremes.

Each climatic design type is characterized by one or more daily weather cycles that show the ranges of daily temperatures, humidities, and solar radiation in which materiel must operate if it is intended for use in the areas indicated on the climatic location map (Figure 1). Associated weather elements of paragraph 5 also have worldwide distribution but, unlike the weather elements constituting the climatic design types, they do not have well-defined

MIL-STD-810H
PART THREE

daily cycles. Since these weather elements are associated with irregularly occurring storms and fronts rather than the daily sun cycle, they are described by instantaneous or short term extremes, and by relative frequency of occurrence.

3.2.2 Climatic testing.

Materiel under development should be tested in climatic chambers, and undergo natural (i.e., field) environmental tests. Included in this Part is general information on climatic and weather-elements (environmental conditions) that are known to affect the operation, storage, and transit of military materiel.

3.2.3 Laboratory climatic tests.

The use of laboratory climatic tests is encouraged, especially under combined (e.g., temperature and humidity) and sequential conditions. In most cases, it is not possible to duplicate exact combined conditions of the applicable climatic design values in these tests. The materiel, however, will be tested to meet the guidelines of the requirements document. Unless otherwise justified, **developers conducting laboratory climatic tests should use the daily cycles normally found in nature as their models, rather than chamber testing only at the extreme condition.** This daily cycling gives more realistic moisture condensation and temperature response patterns. Test planners and environmental engineering specialists will consult with each other on how the climatic design values apply to testing.

3.2.4 Accelerated and aggravated climatic tests.

Accelerated climatic tests are not addressed in this standard, however, some climatic methods do address the aggravated environment. Aggravated tests involve subjecting materiel to more extreme conditions than are found in nature. The results of accelerated and aggravated tests are evaluated in terms of what they imply for future service performance. Specifically, they give rapid feedback on problems requiring corrective action, as well as statistical data on the margin of safety provided by the design. Comparing results of these tests with the results of field climatic tests of service performance will give a better correlation of results. It also increases confidence in the use of such techniques in subsequent similar situations. In chamber tests, developers are cautioned that subjecting materiel to more extreme conditions than are found in nature may introduce problems that will not occur when testing is conducted in the natural environment. On the other hand, the successful conclusion of chamber tests does not guarantee that materiel will operate satisfactorily in the natural environment, because nature involves complex, synergistic effects that cannot presently be induced in chambers. Such factors must be considered by the developer when evaluating results obtained in chambers. Test planners and environmental engineering specialists will consult with each other to determine the extreme combinations of conditions that occur in nature.

MIL-STD-810H
PART THREE**4. ENVIRONMENT ELEMENTS - Climatic Design Types - Natural and Induced.**

Table I provides a comprehensive summary of the commonly accepted natural environment climatic design types, as well as published induced (storage and transit) conditions. Note that when considering the "Storage and Transit" values, the values shown are cyclic, and use of the "Daily High" values may be an overttest based on the LCEP.

TABLE I. Summary of climatic conditions and daily cycles of temperature, solar radiation, and RH.

Climatic Design Type	Daily Cycle ¹	Operational Conditions				Storage and Transit Conditions		
		Ambient Air Temperature ² °C (°F)		Solar Radiation W/m ² (Bph ³)	Ambient Relative Humidity (Percent RH ⁴)	Induced Air Temperature °C (°F)		Induced Relative Humidity (Percent RH)
		Daily Low	Daily High			Daily Low	Daily High	
Hot	Hot Dry (A1)	32 (90)	49 (120)	0 to 1120 (0 to 355)	8 to 3	33 (91)	71 (160)	7 to 1
	Hot Humid (B3)	31 (88)	41 (105)	0 to 1080 (0 to 343)	88 to 59	33 (91)	71 (160)	80 to 14
Basic	Constant High Humidity (B1)	Nearly Constant 24 (75)		Negligible	95 to 100	Nearly Constant 27 (80)		95 to 100
	Variable High Humidity (B2)	26 (78)	35 (95)	0 to 970 (0 to 307)	100 to 74	30 (86)	63 (145)	75 to 19
	Basic Hot (A2)	30 (86)	43 (110)	0 to 1120 (0 to 355)	44 to 14	30 (86)	63 (145)	44 to 5
	Intermediate ⁶ (A3)	28 (82)	39 (102)	0 to 1020 (0 to 323)	78 to 43	28 (82)	58 (136)	See note ⁵
	Basic Cold (C1)	-32 (-25)	-21 (-5)	Negligible	Tending toward saturation	-33 (-28)	-25 (-13)	Tending toward saturation
Cold	Cold (C2)	-46 (-50)	-37 (-35)	Negligible	Tending toward saturation	-46 (-50)	-37 (-35)	Tending toward saturation
Severe Cold	Severe Cold (C3)	-51 (-60)		Negligible	Tending toward saturation	-51 (-60)		Tending toward saturation

¹ Designations in parentheses refer to corresponding climatic categories in MIL-HDBK-310 and AR-70-38 (except the A-3 category) and NATO STANAG 4370, AECTP 200, AECTP 230, (see Part One, paragraphs 2.2.1, 2.2.2, and 2.3).

² °C values (rounded to the nearest whole degree) derived from data obtained/established on °F scale.

³ Bph represents British Thermal Units per square foot per hour.

⁴ Sequence of RH presentation corresponds to sequence of air temperatures shown (e.g., for HOT-DRY daily cycle, 8 percent RH occurs at 32°C (90°F); 3 percent RH occurs at 49°C (120°F).

⁵ Relative humidity for the A3 storage condition vary to widely between different situations to be represented by a single set of conditions.

⁶ Values are only found in NATO STANAG 4370, AECTP 230.

NOTE: The numbers shown for the values of the climatic elements represent only the upper and lower limits of the cycles that typify days during which the extremes occur, e.g., for the Hot-Dry cycle, 49°C (120°F) is the maximum daytime temperature, and 32°C (90°F) is the minimum nighttime (or early morning) temperature.

4.1 Hot climatic design type.

Two daily cycles represent conditions that occur within the hot climatic design type areas. Of these the hot-dry is much more extensive than the hot-humid.

MIL-STD-810H
PART THREE

4.1.1 High temperature. (Paragraph 6.1, reference a, paragraph 5.1.1.)

Temperatures presented were observed in standard meteorological instrument shelters. They represent temperatures of free air in the shade about 1.5m above the ground. These temperatures will normally be encountered only during strong sunshine and fairly light winds. Ground surface temperatures will attain temperatures 15 to 30°C (59 to 86°F) higher than that of free air, depending on radiation, conduction, wind, and turbulence. Air layers very close to the surface will be only slightly cooler than the ground, but the decrease with height above the surface is exponential, so temperatures at 1m will be only slightly warmer than those observed in the instrument shelter.

The temperature of materiel exposed to high temperatures will vary greatly with the physical properties of the materiel affecting heat transfer and capacity, and with the type of exposure. The heat load from a realistic diurnal air temperature and solar radiation cycle make up only a part of the heat transferred to the materiel. The materiel temperature will also be dependent on solar radiation reflected to it from the ground, long wave radiation from the heated ground, long wave radiation to the cold sky, scattered solar radiation from the sky and nearby clouds, the vertical temperature distribution in the free air surrounding the materiel, and total ventilation from wind and turbulence.

- a. Highest Recorded. The world's highest recorded surface temperature, 56.7 °C (134 °F), was measured on 10 July 1913 at Greenland Ranch (Death Valley), California, USA.
- b. Frequency of Occurrence. Because of insufficient hourly data to determine the distribution of high temperature versus frequency of occurrence on a global basis, a statistical technique was used to estimate percentile temperatures for thousands of locations worldwide. The high temperature analyses were used to determine the areas of the world with the highest 1-, 5-, and 10-percent temperatures during the worst month.

The hottest area of the world lies in the interior of northern Africa eastward to India. The hottest part of this area is the Sahara desert that qualifies as the worst part of the world for high temperature. The 1-, 5-, and 10-percent temperatures are 49°C (120°), 46°C (115°F), and 45°C (113°F), respectively.

Hot extremes are part of a well pronounced diurnal cycle. The daily maximum lasts only a couple of hours. However, it is accompanied by intense solar radiation that causes materiel to attain temperatures considerably higher than free air values. Therefore, a realistic diurnal cycle should be considered with the hot extreme. The cycle should also include wind speed that serves as a limiting factor to heat intensification. The moisture content should also be considered because the extremely low relative humidities that can be present during the hottest situations, may present special design problems.

If designing for the 1-percent temperature any place in the world during the warmest month of the year, use the diurnal cycle in which the air temperature attains a maximum of at least 49°C (120°F) at a height of about 1.5m above the ground. Table II describes the A1 climatic category to include the associated solar radiation, relative humidity, and wind speed. Diurnal cycles associated with the 5- and 10-percent temperatures can be approximated by subtracting 3°C and 4C (5°F and 9°F) and, respectively, from each of the hourly temperatures in Table II. Values for the other elements in the cycle would not vary significantly from those associated with the 1-percent value because lower temperatures could be caused by other meteorological conditions.

- c. Long-term extremes. Long term high temperature extremes that would be expected to occur at least once during 10, 30, and 60 years in the hottest part of the world are 53°C (128°F), 54°C (130°F), and 55°C (131°F), respectively (see Table III). These values were derived from statistical analysis of 57 years of temperature data from Death Valley, California, and are considered representative of conditions in the Sahara desert. Table III includes diurnal cycles, associated solar radiation, relative humidity, and wind speeds.

Temperatures presented were observed in standard meteorological instrument shelters. They represent temperatures of free air at about 1.5m (4.9 ft) above the ground surface. Temperatures within a few cm of the surface could be 4 to 5°C (8°F and 9°F) colder. Typically this is not referred to as a climatic design type. However, the LCEP may delineate the need for these values.

4.1.1.1 Hot-dry cycle (A1).

- a. Location. Hot-dry conditions are found seasonally in the deserts of northern Africa, the Middle East, Pakistan, and India, southwestern United States, north central Australia, and northern Mexico (Figure 1).

MIL-STD-810H
PART THREEb. Temperature, humidity, solar radiation.

- (1) Operational conditions. On the extreme hot-dry days, temperature, humidity, and solar radiation may follow a pattern similar to that shown in Table II. Nominal accompanying wind speeds at the time of high temperatures are 4 mps (13 fps). The maximum ground surface temperature is 63°C (145°F). At ground elevations above 915m (3,000 feet), maximum air temperatures will be lower by approximately 9.1°C per 1,000m (5°F per 1,000 ft.), and solar radiation may be higher by approximately 43 W/m² per 1,000m (4 BTU/ft²/hr (British thermal units per square foot per hour)) per 1,000 feet, to 4572m (15,000 feet).
- (2) Storage and transit conditions. The daily cycle for storage and transit in Table II shows 5 continuous hours with air temperatures above 66°C (150°F), and an extreme air temperature of 71°C (160°F) for not more than 1 hour. Testing for these conditions should be done, if practical, according to the daily cycle because prolonged exposure to the high temperature extremes may impose an unrealistic heat load on materiel. If not practical, testing will be done at a temperature representative of the peak temperature that the materiel would attain during a daily cycle.

4.1.1.2 High Temperature with low relative humidity.

The lowest relative humidities approach zero percent in hot deserts distant from bodies of water.

- a. Lowest Recorded. The lowest recorded relative humidity of 2 percent at 43.3°C (110°F) was recorded in Death Valley, California.
- b. Frequency of Occurrence. Since the percentile values of low relative humidity vary very little, the RH cycle (A1) shown in Table II is recommended.
- c. Long-term Extremes. The recommended low relative-humidity cycle associated with the long-term high temperature extremes can be found in Table III.

MIL-STD-810H
PART THREE

Table II. Hot climatic design type A1: Hot-dry daily cycle (Natural and Induced).

Local Time	OPERATIONAL CONDITIONS (Natural Environment)							STORAGE AND TRANSIT CONDITIONS	
	Ambient Air Temp.	Solar Radiation		Relative Humidity	Dewpoint Temp.	Wind (at 3m)		Induced Air Temp.	Relative Humidity
		(LST)	°C (°F)	Bph	W/m ²	Percent	°C (°F)	m/s	ft/sec
0100	35 (95)	0	0	6	-7 (19)	3	9	35 (95)	6
0200	34 (94)	0	0	7	-6 (21)	3	9	34 (94)	7
0300	34 (93)	0	0	7	-7 (20)	3	9	34 (93)	7
0400	33 (92)	0	0	8	-6 (22)	3	9	33 (92)	7
0500	33 (91)	0	0	8	-6 (22)	3	9	33 (92)	7
0600	32 (90)	18	55	8	-6 (22)	3	9	33 (91)	7
0700	33 (91)	85	270	8	-6 (22)	3	9	36 (97)	5
0800	35 (95)	160	505	6	-7 (19)	3	9	40 (104)	4
0900	38 (101)	231	730	6	-5 (23)	3	9	44 (111)	4
1000	41 (106)	291	915	5	-4 (24)	4	14	51 (124)	3
1100	43 (110)	330	1040	4	-6 (21)	4	14	56 (133)	2
1200	44 (112)	355	1120	4	-5 (23)	4	14	63 (145)	2
1300	47 (116)	355	1120	3	-8 (18)	4	14	69 (156)	1
1400	48 (118)	330	1040	3	-9 (16)	4	14	70 (158)	1
1500	48 (119)	291	915	3	-8 (18)	4	14	71 (160)	1
1600	49 (120)	231	730	3	-7 (19)	4	14	70 (158)	1
1700	48 (119)	160	505	3	-8 (18)	4	14	67 (153)	1
1800	48 (118)	85	270	3	-9 (16)	4	14	63 (145)	2
1900	46 (114)	18	55	3	-7 (19)	4	14	55 (131)	2
2000	42 (108)	0	0	4	-7 (20)	4	14	48 (118)	3
2100	41 (105)	0	0	5	-6 (22)	4	14	41 (105)	5
2200	39 (102)	0	0	6	-4 (24)	4	14	39 (103)	6
2300	38 (100)	0	0	6	-6 (22)	4	14	37 (99)	6
2400	37 (98)	0	0	6	-7 (20)	3	9	35 (95)	6

MIL-STD-810H
PART THREE**Table III. Daily cycle of temperature & other elements associated with worldwide long-term extremes of high temperature.** (See paragraph 4.1.1c.)

Local Time	Temperature °C (°F)			RH (Percent)	Wind (at 3m (10 ft))		Solar Radiation	
	Period (yrs)				m/s	(ft/s)	(W/m ²)	(Bph)
(LST)	10	30	60					
0100	36(97)	36(97)	36(97)	6	3	9	0	0
0200	36(96)	36(96)	36(96)	7	3	9	0	0
0300	36(96)	36(96)	36(96)	7	3	9	0	0
0400	34(94)	34(94)	34(94)	8	3	9	0	0
0500	33(92)	33(92)	33(92)	8	3	9	0	0
0600	33(91)	33(91)	33(91)	8	3	9	55	18
0700	33(92)	33(92)	33(92)	8	3	9	270	85
0800	36(97)	36(97)	36(97)	6	3	9	505	160
0900	41(105)	41(106)	41(106)	6	3	9	730	231
1000	43(110)	44(112)	44(112)	5	4	14	915	291
1100	46(115)	47(117)	47(117)	4	4	14	1040	330
1200	48(119)	49(120)	49(121)	4	4	14	1120	355
1300	51(123)	52(125)	52(126)	3	4	14	1120	355
1400	52(126)	53(128)	54(129)	3	4	14	1040	330
1500	53(127)	54(129)	54(130)	3	4	14	915	291
1600	53(128)	54(130)	55(131)	3	4	14	730	231
1700	53(127)	54(129)	54(130)	3	4	14	505	160
1800	52(125)	53(127)	53(128)	3	4	14	270	85
1900	49(121)	50(122)	51(123)	3	4	14	55	18
2000	45(113)	46(114)	46(115)	4	4	14	0	0
2100	43(110)	44(114)	44(111)	5	4	14	0	0
2200	41(106)	42(107)	42(108)	6	4	14	0	0
2300	39(103)	40(104)	40(104)	6	4	14	0	0
2400	38(101)	39(102)	39(102)	6	3	9	0	0

4.1.2 High temperature with high humidity.

Since very high absolute humidities can occur with even higher temperatures than those in paragraph 4.1.3, this paragraph provides guidance on the joint occurrence of high humidities with temperatures above 41°C (106°F). These extremes occur in the coastal deserts surrounding the Persian Gulf, Gulf of Aden, and the Red Sea. Abadan, Iran was determined as representative of the world's most extreme high temperature, high-humidity environment.

- a. **Highest Recorded.** The highest recorded temperature of 48.3°C (119°F) with a concurrent dew point of 29.4°C (85°F) was recorded at Abadan, Iran on 24 July 1953.
- b. **Frequency of Occurrence.** Seven years of data for Abadan, Iran were analyzed to determine the following joint frequencies of occurrence shown in Table IV:

MIL-STD-810H
PART THREE**Table IV. Abadan frequencies of occurrence of high temperatures with high humidity.**

Temperature °C (°F)	Dew Point °C (°F)		
	1 percent	5 percent	10 percent
46.1 (115)	27.2 (81)	21.7 (71)	*
43.3 (110)	27.8 (82)	24.4 (76)	20 (68)

*The indicated temperature does not occur often.

- c. **Long-term Extremes.** The 7 years of data available for Abadan were insufficient for extreme value analysis to determine the long-term extremes in the same format presented for most other elements. Therefore, the 0.1-percent joint values of temperature and dew point were calculated to satisfy more stringent design requirements. Temperatures and respective dew points having a joint frequency of occurrence of 0.1 percent are: 48.9°C (120°F) with a dew point of 25.6°C (78°F), 46.1°C (115°F) with a dew point of 31.1°C (88°F), and 43.3°C (110°F) with a dew point of 31.1°C (88°F).

4.1.3 High absolute humidity.

Absolute humidity is the mass of water vapor in a specified volume of air. The dew point, the temperature at which condensation would occur if the air was cooled at constant pressure, is the observed meteorological element used to calculate the absolute humidity. Since the amount of water vapor the air can hold increases with temperature, areas with the highest absolute humidities are hot locations (usually at the edge of a desert) adjacent to very warm bodies of water. (See paragraph 6.1, reference a, paragraph 5.1.3 for further explanation.)

- a. **Highest Recorded.** The highest accepted dew point observation is 35°C (95°F) and occurred at Dhahran, Saudi Arabia on 8 July 2003. The previous high was 34°C (93°F), (100 percent RH and 93.2 °F) recorded in July (exact date unknown) at Sharjah, Arabia, on the shore of the Persian Gulf.
- b. **Frequency of Occurrence.** The highest dew points in the world were recorded along the narrow deserts of the Red Sea, Gulf of Aden, and the Persian Gulf eastward to the northern Arabian Sea. In this area, Abadan, Iran, was found to have the highest dew point occurring 1 percent of the time in the worst month, 31°C (88°F).

Although Abadan has the highest 1-percent extreme, extremes for higher percents are found in regions where the dew points are somewhat lower but more nearly constant. The 5-, 10-, and 20-percent dew point extremes are 30°C (86°F), 29°C (84°F), and 28°C (83°F) respectively. These values were determined using data from Belize City, Belize (see MIL-HDBK-310, Table V).

Using the Abadan data, a synthetic cycle associated with the 1-percent dew point extreme was constructed and is given in Table IV. It shows the 1-percent dew point of 31°C (88°F) persisting for 7 hrs, a maximum temperature of 41°C (105°F) and a dew point of 29°C (84°F) or higher for the full cycle.

- c. **Long-term Extremes.** The long term extreme occurrence of dew point is about 2°C (3.6 °F) more than the 1-percent value. This may not be as detrimental to materiel as a somewhat lower dew point occurring for an extended period of time. The long term extreme will be a repetition of a daily cycle typical of a location experiencing high absolute humidities for extended periods of time.

4.1.3.1 Hot-humid cycle (B3).

- a. **Location.** These severe dewpoint conditions occur only along a very narrow coastal strip (probably less than 8 km (5 miles)) bordering bodies of water with high surface temperatures, specifically the Persian Gulf and the Red Sea. The hot-humid cycle will be used as a design condition only for systems intended for use or likely to be used in these limited areas. Areas reporting these highest worldwide dewpoints may also experience hot-dry conditions at other times.
- b. **Temperature, humidity, solar radiation.**
- (1) **Operational conditions.** On days with extremely high dewpoints (high absolute humidity), a cycle such as that in Table V may occur, along with wind speeds between 2.4 and 5.2 mps (8 and 17 fps), and a maximum ground surface temperature of 54°C (130°F).
 - (2) **Storage and transit conditions.** Induced storage temperatures are presumed to be the same as those for the hot-dry cycle, although relative humidities in the enclosed space are considerably higher.

MIL-STD-810H
PART THREE

Table V. Hot climatic design type B3: Hot-humid daily cycle.

Local Time	OPERATIONAL CONDITIONS (Natural Environment)							STORAGE AND TRANSIT CONDITIONS		
	Ambient Air Temperature		Solar Radiation		Relative Humidity	Dewpoint Temperature		Induced Air Temperature		Relative Humidity
	°C	°F	W/m ²	Bph	Percent	°C	°F	°C	°F	Percent
0100	31	88	0	0	88	29	84	35	95	67
0200	31	88	0	0	88	29	84	34	94	72
0300	31	88	0	0	88	29	84	34	94	75
0400	31	88	0	0	88	29	84	34	93	77
0500	31	88	0	0	88	29	84	33	92	79
0600	32	90	45	15	85	29	85	33	91	80
0700	34	93	315	100	80	30	86	36	97	70
0800	36	96	560	177	76	31	87	40	104	54
0900	37	98	790	251	73	31	88	44	111	42
1000	38	100	950	302	69	31	88	51	124	31
1100	39	102	1035	328	65	31	88	57	135	24
1200	40	104	1080	343	62	31	88	62	144	17
1300	41	105	1000	317	59	31	88	66	151	16
1400	41	105	885	280	59	31	88	69	156	15
1500	41	105	710	225	59	31	88	71	160	14
1600	41	105	465	147	59	31	88	69	156	16
1700	39	102	210	66	65	31	88	66	151	18
1800	37	99	15	4	69	31	87	63	145	21
1900	36	97	0	0	73	31	87	58	136	29
2000	34	94	0	0	79	30	86	50	122	41
2100	33	91	0	0	85	30	86	41	105	53
2200	32	90	0	0	85	29	85	39	103	58
2300	32	89	0	0	88	29	85	37	99	62
2400	31	88	0	0	88	29	84	35	95	63

4.2 Basic climatic design type.

Four daily cycles represent conditions that may be found in areas where the basic climatic design type prevails. Two of these cycles represent high humidity conditions and two represent the extreme temperatures of the basic set of design values.

4.2.1 High relative humidity with high temperature.

Relative humidity (RH) indicates the degree of saturation of the air. It is the ratio of the actual vapor pressure of the air to the saturation vapor pressure.

The maximum RH of 100 percent is encountered in nature at temperatures up to about 30 to 32°C (86 to 90°F) directly over water surfaces adjacent to coastal deserts. Over much of the world's tropical areas, 100 percent RH with temperatures up to 26°C (79°F) occurs quite frequently. One hundred percent RH is closely approached in tropical jungles.

- a. Highest Recorded. High recorded surface relative humidities of 100 percent with fairly high temperatures are common in the moist tropics. An observed RH of 100 percent with a temperature of 30°C (86°F) at Dobochoora, Papua, New Guinea has undoubtedly occurred at other locations in the moist tropics.
- b. Frequency of Occurrence. Large open areas of the tropics have high relative humidities with high temperature. Giving the 1-percent high RH is meaningless for design, since the 5-percent value is as high

MIL-STD-810H
PART THREE

as 100 percent in many areas. The conditions shown in Table VII (B2 – Variable High Humidity) may be found in open moist tropical areas during any month of the year. Examples of stations with such extremes are Calcutta (India), Seno (Laos), Kampot (Cambodia), Hanoi (North Vietnam), Nanking (China), Kwajalein Atoll, Paramaribo (Surinam), and Georgetown (Guyana).

- c. Long-term Extremes. As a minimum, materiel should be designed for long-term exposure to nearly constant high RH and high temperature of Table VI (B1 – Constant High Humidity). Such a daily cycle prevails in jungles under the canopy of tropical rainforests. The primary feature of this condition is the long duration of RH at and above 95 percent. These conditions may occur on several days during any month of the year, but are more prevalent during rainy seasons. Solar radiation is negligible for this cycle.

4.2.2 High humidity daily cycles.

- a. Location. Basic high humidity conditions are found most often in tropical areas, although they occur briefly or seasonally in the mid-latitudes. One of the two high humidity cycles (B1 - constant high humidity) represents conditions in the heavily forested areas in the tropics under heavy cloud cover, where nearly constant conditions may prevail during rainy and wet seasons. Exposed materiel is likely to be constantly wet or damp for many days at a time. The other daily cycle (B2 - variable high humidity) represents conditions found in the open in tropical areas, with clear skies or intermittent cloudiness. In the first cycle, exposed materiel is likely to be constantly wet or damp for many days at a time. In the second cycle, exposed items are subject to alternate wetting and drying. Both conditions promote severe deterioration in materiel. The one that is most important, as shown below, depends on the nature of the materiel involved.

<u>Type Material</u>	<u>Type of Site with the Highest Deterioration Rates</u>
Elastomers	Open
Polymers	Open
Textiles	Forest
Metals	Coastal swamp (mangrove) and forest

- (1) The climate station selected for these categories was Majuro, Marshall Islands (7°05' N, 171°23'E). The station is located Weather Services Building at the Majuro Airport. This site is a first-order U.S. weather reporting station. Majuro was selected over 12 available candidate stations from around the world initially because it possessed the required temperature and precipitation characteristics (to create high relative humidity) for the B1 category, and it met the criteria for data availability and quality.
- (2) On the average, Majuro receives over 130" (3,300 mm) of rainfall annually. Over 250 days experience rainfall $\geq 0.254\text{mm}$ (0.01") and over 310 days experience rainfall \geq trace. Ten years of continuous data were used for the analysis (Period of Record (POR): 1973-1982).
- (3) Groupings of consecutive days of rainfall were then extracted. The longest continuous streak of consecutive days \geq trace was 51. A cumulative frequency curve was then created. The recommended duration value of 45 days represents the 99th percentile value (actual value = 98.64percent).

MIL-STD-810H
PART THREE

4.2.3 Temperature, humidity, solar radiation (constant high humidity cycle (B1)).

- a. Operational conditions. Relative humidity above 95 percent in association with a nearly constant temperature at 24°C (75°F) persists for periods of several days (Table VI).
- b. Storage and transit conditions. Relative humidity above 95 percent in association with nearly constant 27°C (80°F) temperature occurs for periods of a day or more.

Table VI. Basic climatic design type B1: Constant high humidity daily cycle.

Local Time	OPERATIONAL CONDITIONS (Natural Environment)						STORAGE AND TRANSIT CONDITIONS			
	Ambient Air Temperature		Solar Radiation		Relative Humidity	Dewpoint Temperature		Induced Air Temperature		Relative Humidity
	°C	°F	Bph	W/m ²	Percent	°C	°F	°C	°F	Percent
0100	Nearly constant at 24°C (75°F) throughout the 24 hours.	Negligible			100	24	75	Nearly constant at 27°C (80°F) Throughout the 24 hours.		Same as operational conditions.
0200					100	24	75			
0300					100	24	75			
0400					100	24	75			
0500					100	24	75			
0600					100	24	75			
0700					98	23	74			
0800					97	23	74			
0900					95	23	74			
1000					95	23	74			
1100					95	23	74			
1200					95	23	74			
1300					95	23	74			
1400					95	23	74			
1500					95	23	74			
1600					95	23	74			
1700					95	23	74			
1800					95	23	74			
1900					97	23	74			
2000					98	23	74			
2100					100	24	75			
2200					100	24	75			
2300					100	24	75			
2400					100	24	75			

4.2.4 Temperature, humidity, solar radiation (variable high humidity cycle (B2)).

- a. Operational conditions. The daily cycle outlined in Table VII has a maximum ambient air temperature of 35°C (95°F) for 2 hours. The maximum solar radiation load of 907 W/m² (307 Bph) for not more than 2 hours, is accompanied by wind speeds of less than 2 mps (7 fps) and a maximum ground surface temperature of 54°C (130°F).
- b. Storage and transit conditions. See storage and transit conditions associated with the hot-humid daily cycle of the hot climatic design type.

MIL-STD-810H
PART THREE

Table VII. Basic climatic design type B2: Variable high humidity daily cycle.

Local Time	OPERATIONAL CONDITIONS (Natural Environment)							STORAGE AND TRANSIT CONDITIONS		
	Ambient Air Temperature		Solar Radiation		Relative Humidity	Dewpoint Temperature		Induced Air Temperature		Relative Humidity
	°C	°F	W/m ²	Bph	Percent	°C	°F	°C	°F	Percent
0100	27	80	0	0	100	27	80	33	91	69
0200	26	79	0	0	100	26	79	32	90	70
0300	26	79	0	0	100	26	79	32	90	71
0400	26	79	0	0	100	26	79	31	88	72
0500	26	78	0	0	100	26	78	30	86	74
0600	26	78	45	15	100	26	78	31	88	75
0700	27	81	230	73	94	26	79	34	93	64
0800	29	84	435	138	88	27	80	38	101	54
0900	31	87	630	200	82	27	81	42	107	43
1000	32	89	795	252	79	28	82	45	113	36
1100	33	92	900	286	77	28	83	51	124	29
1200	34	94	970	307	75	29	84	57	134	22
1300	34	94	970	307	74	29	84	61	142	21
1400	35	95	900	286	74	29	85	63	145	20
1500	35	95	795	252	74	30	86	63	145	19
1600	34	93	630	200	76	29	85	62	144	20
1700	33	92	435	138	79	29	84	60	140	21
1800	32	90	230	73	82	29	84	57	134	22
1900	31	88	45	15	86	28	83	50	122	32
2000	29	85	0	0	91	28	83	44	111	43
2100	28	83	0	0	95	28	82	38	101	54
2200	28	82	0	0	96	27	81	35	95	59
2300	27	81	0	0	100	27	81	34	93	63
2400	27	80	0	0	100	27	80	33	91	68

4.2.5 Basic hot daily cycle (A2).

a. Location. Basic hot conditions exist in many parts of the world extending outward from the areas of hot-dry conditions in the United States, Mexico, northern Africa, southwestern Asia, India, Pakistan, and southern Spain in the northern hemisphere, and smaller sections of South America, southern Africa, and Australia in the southern hemisphere.

b. Temperature, humidity, solar radiation.

(1) Operational conditions. Design criteria are: eight continuous hours with an ambient air temperature above 41°C (105°F) with an extreme temperature of 43°C (110°F) for not more than 3 hours; a maximum ground surface temperature of 60°C (140°F); solar radiation (horizontal surface) at a rate of 1120 W/m² (355 Bph) for not more than 2 hours (not concurrent with the extreme temperature); a wind speed between 3 and 5 mps (10 and 16 fps) during the period with temperature above 41°C (105°F); and a relative humidity of approximately 14 percent concurrent with the high temperatures (Table VIII).

For elevations of 914 to 3048m (3,000 to 10,000 feet), the ground surface temperature and wind remain the same. Ambient air temperatures, however, decrease 9.1°C per 1,000 m (5°F per 1,000 feet) and solar radiation increases at a rate of 43 W/m² per 1,000m (4 Bph per 1,000 feet).

MIL-STD-810H
PART THREE

- (2) Storage and transit conditions. Design criteria are: Four continuous hours with an induced air temperature above 60°C (140°F) with relative humidity less than 8 percent; use an air temperature extreme of 63°C (145°F) for not more than 2 hours without benefit of solar radiation and with negligible wind (Table VIII).

Table VIII. Basic climatic design type A2: Basic hot daily cycle.

Local Time	OPERATIONAL CONDITIONS (Natural Environment)							STORAGE AND TRANSIT CONDITIONS		
	Ambient Air Temperature		Solar Radiation		Relative Humidity	Dewpoint Temperature		Induced Air Temperature		Relative Humidity
	°C	°F	W/m ²	Bph	Percent	°C	°F	°C	°F	Percent
0100	33	91	0	0	36	15	61	33	91	36
0200	32	90	0	0	38	16	60	32	90	38
0300	32	90	0	0	41	17	63	32	90	41
0400	31	88	0	0	44	17	62	31	88	44
0500	30	86	0	0	44	17	62	30	86	44
0600	30	86	55	18	44	17	62	31	88	43
0700	31	88	270	85	41	16	61	34	93	37
0800	34	93	505	160	34	16	61	38	101	30
0900	37	99	730	231	29	17	62	42	107	23
1000	39	102	915	291	24	14	58	45	113	17
1100	41	106	1040	330	21	14	58	51	124	14
1200	42	107	1120	355	18	13	55	57	134	8
1300	43	109	1120	355	16	11	52	61	142	6
1400	43	110	1040	330	15	11	52	63	145	6
1500	43	110	915	291	14	10	50	63	145	5
1600	43	110	730	231	14	10	50	62	144	6
1700	43	109	505	160	14	9	49	60	140	6
1800	42	107	270	85	15	9	49	57	134	6
1900	40	104	55	18	17	10	50	50	122	10
2000	38	100	0	0	20	11	51	44	111	14
2100	36	97	0	0	22	11	51	38	101	19
2200	35	95	0	0	25	12	54	35	95	25
2300	34	93	0	0	28	12	54	34	93	28
2400	33	91	0	0	33	14	58	33	91	33

4.2.6 Basic cold daily cycle (C1).

- a. Location. Extensive basic cold conditions are found only in the Northern Hemisphere south of the coldest areas and on high latitude coasts (e.g., the southern coast of Alaska) where maritime effects prevent occurrence of very low temperatures, as well as southern Canada, the coast of southern Greenland, northern Europe, the former Soviet Union, and central Asia. Small areas of basic cold weather conditions may be found at high elevations in lower latitudes.
- b. Temperature, humidity, solar radiation.

(1) Operational conditions.

Design conditions are: five continuous hours with an ambient air temperature of -31°C (-25°F); a minimum ground surface temperature of -37°C (-35°F); wind speed less than 5 mps (16 fps); negligible solar radiation (horizontal surface); and humidity tending toward saturation (Table IX). Saturation is the result of the extremely low temperatures. The absolute humidity and vapor pressure are very low when these

MIL-STD-810H
PART THREE

temperatures prevail. Although not typical, wind speeds greater than 16 fps may be associated with temperatures of -31°C (-25°F).

(2) Storage and transit conditions. Design criteria are five continuous hours with an induced air temperature of -33°C (-28°F) with no wind or solar radiation, and humidity tending toward saturation Table IX).

Table IX. Basic climatic design type C1; Cold daily cycle.

Local Time	OPERATIONAL CONDITIONS (Natural Environment)					STORAGE AND TRANSIT CONDITIONS		
	Ambient Air Temperature		Solar Radiation		Relative Humidity	Induced Air Temperature		Relative Humidity
	°C	°F	W/m ²	Bph	Percent	°C	°F	Percent
0100	-31	-24	Negligible During Low Temperature Periods		Tending Towards Saturation	-33	-27	Tending Toward Saturation
0200	-32	-25				-33	-28	
0300	-32	-25				-33	-28	
0400	-32	-25				-33	-28	
0500	-32	-25				-33	-28	
0600	-32	-25				-33	-28	
0700	-30	-22				-33	-27	
0800	-28	-18				-33	-27	
0900	-26	-15				-32	-26	
1000	-24	-12				-31	-24	
1100	-22	-8				-30	-22	
1200	-21	-5				-28	-19	
1300	-21	-5				-27	-17	
1400	-21	-6				-26	-15	
1500	-21	-6				-25	-13	
1600	-22	-8				-26	-15	
1700	-24	-11				-28	-18	
1800	-25	-13				-29	-20	
1900	-26	-15				-30	-22	
2000	-27	-17				-31	-24	
2100	-28	-19				-32	-26	
2200	-29	-21				-33	-27	
2300	-30	-22				-33	-27	
2400	-31	-24				-33	-27	

4.3 Cold and severe cold design types.

Two daily cycles represent the “Cold” (C2) and “Severe Cold” (C3) climatic design types. The “Cold” design type is more extensive than the “Severe Cold” (see Figure 1), but ensure the LCEP reflects the proper design type before applying either one.

4.3.1 Low temperature.

Low temperature extremes result from the optimum combination of several meteorological elements. Long absence of solar radiation, clear skies, a snow cover, and calm air are the most essential requirements, with the ultimate fall in temperature dependent on the duration of these conditions. Since these conditions can exist for extended periods at high-latitude continental areas, there can be much longer durations of cold than high temperatures, that have a diurnal dependence.

MIL-STD-810H
PART THREE

Temperatures presented were observed in standard meteorological instrument shelters. They represent temperatures of free air at about 1.5m (4.9 ft) above the snow surface. Temperatures within a few cm of the surface could be 4 to 5°C (7 to 9°F) colder.

a. Lowest Recorded.

Excluding Antarctica, the generally accepted world's lowest recorded temperature is -68°C (-90°F). It was recorded at Verkhoyansk, USSR (elevation 105m (345 ft)), on 5 and 7 February 1892, and at Oymyakon, USSR (elevation 660m (2165 ft)) on 6 February 1933.

b. Frequency of Occurrence.

Because of insufficient hourly data to determine the distribution of low temperature versus frequency of occurrence on a global basis, a statistical technique was used to estimate percentile temperatures for thousands of locations worldwide. The low temperature analyses were used to determine the areas of the world with the coldest temperatures occurring 1-, 5-, 10-, and 20-percent of the time during the worst month. The 20-percent value was added for this element because the low temperatures associated with lower frequencies are limited in geographical extent.

The coldest areas of the world (excluding Antarctica) are the central part of the Greenland ice cap (approximately 2500-3000m elevation (1.55-1.86 miles)), and Siberia between 62° to 68°N, and 125° to 145°E (less than 800m (0.5 mi) elevation). The 1-, 5-, 10-, and 20-percent temperatures in these areas are -61°C (-78°F), -57°C (-70°F), -54°C (-65°F), and -51°C (-60°F), respectively. A diurnal cycle is not provided because the effect of solar radiation during these extreme conditions is minimal. Duration of very cold temperatures is an important consideration. Studies indicate that during a 24 hour period the maximum temperatures would exceed the percentile temperatures by only about 3°C (5°F)

c. Long-term Extremes.

Low temperatures that could be expected to occur at least once during 10, 30, and 60 years in the coldest area of the world are -65°C (-78°F), -67°C (-89°F), and -69°C (-92°F), respectively. These values were derived from statistical analysis of 16 years of temperature data from Oymyakon, USSR. The 60-year value is lower than the recorded extreme because it represents a longer period than the period of actual observations. Table X provides temperature regimes for 32 days with these temperature minima. Typically this is not referred to as a climatic design type. However, the LCEP may delineate the need for these values.

Table X. Monthly cycle of temperature associated with the worldwide long term low temperature extremes. (See paragraph 4.3.1c.)

Time		Hours Before and After						Days Before and After				
Period (yrs)	Temp	0	0.5	1.5	3	6	12	1	2	4	8	16
10	°C	-66	-66	-66	-65	-65	-64	-63	-59	-55	-49	-42
	°F	-87	-87	-87	-85	-85	-83	-81	-74	-67	-56	-44
30	°C	-67	-67	-67	-67	-67	-66	-64	-62	-57	-51	-45
	°F	-89	-89	-89	-89	-89	-87	-83	-80	-71	-60	-49
60	°C	-69	-69	-68	-68	-67	-67	-65	-63	-58	-53	-47
	°F	-92	-92	-90	-90	-89	-89	-85	-81	-72	-63	-53

MIL-STD-810H
PART THREE

4.3.2 Cold climatic design type (C2).

a. Location.

Cold conditions are found in the Northern Hemisphere in most of Canada, large sections of Alaska, Greenland, northern Scandinavia, northern Asia, and Mongolia. They can also exist in parts of the Tibetan Plateau of Central Asia. Very small areas of the cold type may be found at higher elevations in both the Northern and Southern Hemispheres (e.g., Alps, Himalayas, and the Andes). (See paragraph 2.2.3.)

b. Temperature, humidity, solar radiation.

(1) Operational conditions.

Design conditions are: six continuous hours with an ambient air temperature of -46°C (-50°F); a minimum snow surface temperature of -46°C (-51°F), wind speed less than 5 m/s (11 mph); negligible solar radiation (horizontal surface); and relative humidity tending towards saturation (Table XI).

(2) Storage and transit conditions. Same as operational conditions (Table XII).

Table XI. Cold climatic design type C2: Daily cycle.

Local Time	OPERATIONAL CONDITIONS (Natural Environment)					STORAGE AND TRANSIT CONDITIONS		
	Ambient Air Temperature		Solar Radiation		Relative Humidity	Induced Air Temperature		Relative Humidity
	$^{\circ}\text{C}$	$^{\circ}\text{F}$	Bph	W/m^2	Percent	$^{\circ}\text{C}$	$^{\circ}\text{F}$	Percent
0100	-46	-51	Negligible		Tending Towards Saturation	-46	-51	Tending Towards Saturation
0200	-46	-51				-46	-51	
0300	-46	-51				-46	-51	
0400	-46	-51				-46	-51	
0500	-46	-51				-46	-51	
0600	-46	-51				-46	-51	
0700	-45	-49				-45	-49	
0800	-44	-47				-44	-47	
0900	-43	-45				-43	-45	
1000	-41	-42				-41	-42	
1100	-39	-38				-39	-38	
1200	-37	-35				-37	-35	
1300	-37	-35				-37	-35	
1400	-37	-35				-37	-35	
1500	-37	-35				-37	-35	
1600	-38	-36				-38	-36	
1700	-39	-38				-39	-38	
1800	-39	-38				-39	-38	
1900	-41	-42				-41	-42	
2000	-42	-44				-42	-44	
2100	-43	-45				-43	-45	
2200	-44	-47				-44	-47	
2300	-44	-47				-44	-47	
2400	-45	-49				-45	-49	

MIL-STD-810H
PART THREE

4.3.3 Severe cold climatic design type (C3).

a. Location.

Except for Antarctica that is excluded from consideration because of an international treaty, the severe cold regional type records the world's lowest temperatures. These conditions are found in the Northern Hemisphere in the interior of Alaska extending into the Yukon in Canada. They also exist in the interior of the northern islands of the Canadian Archipelago, on the Greenland icecap, and in Siberia.

b. Temperature, humidity, solar radiation.

- (1) Operational conditions. The design condition is a minimum temperature of -51°C (-60°F). (For testing purposes, this is a cold soak temperature.) Solar radiation (horizontal surface) is negligible and relative humidity tends toward saturation (because of low temperature, not high absolute humidity or vapor pressure). Wind speeds are less than 5 m/s (11 mph). In rare cases where materiel is designed to operate solely in areas where the cold climatic design type applies, the reverse season, or expected maximum, temperature is 35°C (95°F).
- (2) Storage and transit conditions. Same as (1) above.
- (3) Daily Cycle. No cycle in tabular format is given because temperature, humidity, and solar radiation remain nearly constant throughout the 24-hour period.

4.3.4 High relative humidity with low temperature.

High relative humidity in the dry arctic winter is the rule rather than the exception since the loss of heat by radiation during the long nights causes the temperature to drop to the frost point of the air.

- a. Highest Recorded. The highest recorded RH value of 100 percent can be associated with the low temperature extreme given in paragraph 4.3.1a.
- b. Frequency of Occurrence. A value of 100 percent can be associated with the low temperature frequency of occurrence given in paragraph 4.3.1b.
- c. Long-term Extreme. A value of 100 percent can be associated with the low temperature long term extreme given in paragraph 4.3.1c.

4.3.5 Low relative humidity with low temperature. Not available.

4.3.6 Low absolute humidity.

Since the amount of water vapor that can be contained in air is directly proportional to air temperature, lowest absolute humidities will be found with lowest air temperatures. For the low absolute humidity extremes, dew points (referred to as frost points when below freezing) were determined using low temperature extremes with an assumed relative humidity of 90 percent.

- a. Lowest Recorded. The absolute humidity associated with the low temperature extreme of -68°C (-90°F) (see paragraph 4.3.1a) and 90-percent relative humidity is assumed. This corresponds to a frost point of -68.4°C (-91°F).
- b. Frequency of Occurrence. The absolute humidities associated with the low temperature extreme values (see paragraph 4.3.1b) and 90-percent relative humidity are assumed. For the 1-percent low temperature of -61°C (-78°F), this corresponds to a frost point of -62°C (-79°F).
- c. Long-term Extremes. The absolute humidities associated with the low temperature extremes (see paragraph 4.3.1c) and 90-percent relative humidity are assumed. For at least one occurrence in 10, 30, and 60 years this corresponds to frost points of -66.1°C (-87°F), -67.8°C (-90°F), and -69.5°C (-93°F) respectively.

MIL-STD-810H
PART THREE

5. ADDITIONAL ENVIRONMENTAL ELEMENTS.

Several additional climatic or other environmental elements are known to have effects on some kinds of military materiel. The elements are discussed in the following paragraphs and, where possible, operational extremes are given.

5.1 Wind.

5.1.1 Wind element.

Wind is probably the most complex of all climatic elements affecting materiel. Wind effects are difficult to analyze because wind is a vector quantity subject to rapid temporal and spatial changes in speed and direction. In addition to parameters of average speed and direction, a complete description of wind includes the random motions of widely different scales, and periods called "atmospheric turbulence" or "eddies." The wind forces on a structure result from differential pressures, positive and negative, caused by an obstruction to the free flow of the wind. Thus, these forces are functions of the velocity and turbulence of the wind and of the orientation, area, and shape of the elements of the structure.

- a. For operations, the following extremes, as given in MIL-HDBK-310, are: a steady wind speed of 22 m/s (49.2 mph) and a gust of 29 ms (65 mph).
- b. The above operational wind speeds are for a height of 3m (10 feet). Multiplication factors for obtaining speeds at the height of materiel are shown in Table XII.

Table XII. Wind speed multiplication factors at selected heights.

Height		Operational	
Meters	Feet	Steady winds	Gusts
1.5	0.5	0.917	0.946
3	10	1.000	1.000
6	20	1.090	1.057
9	30	1.147	1.092
12	40	1.189	1.117
15	50	1.222	1.137
23	75	1.286	1.175
30	100	1.334	1.202
61	200	1.454	1.271
91	300	1.510	1.313
122	400	1.586	1.343
152	500	1.631	1.368
305	1000	1.778	1.445

5.1.2 Wind speed.

Observations of wind speed are one of the least standardized of all meteorological elements. The exposure and height above the ground of wind-measuring materiel is far from uniform. Because wind speeds near the ground can vary significantly with height and exposure, specifying this variability is an important problem. Another problem is that the interval over which wind speeds are averaged, varies from country to country. The current standard averaging period in the United States, 1 min, is considered representative of the values herein referred to as the "average or steady wind." Gusts associated with steady wind speeds must also be considered.

The gust factor is the ratio of the gust speed to the steady wind speed. Although many factors influence this ratio, one can develop approximations for the gust factor as a function of steady wind speed. Gust speeds reported in weather observations are normally considered to be about 3-sec averages, but for designing various sized materiel, other short-duration gusts are often applicable. A previous study indicates that a gust must have a duration such that its size is about eight times the downwind dimension of a structure in order to produce a force on the structure commensurate with the gust speed. For example, a structure with a 3m (10 ft) downwind dimension must have a 24m (79 ft) long gust to establish full dynamic pressure on the structure. Smaller structures will be sensitive to shorter-duration gusts.

The most probable gust extremes associated with the 1-min steady extremes presented in the following sections are scaled to arbitrarily chosen downwind materiel dimensions of 0.6, 1.5, 3, 8, 15, and 30m (2, 4.9, 10, 26, 49, and 98 ft). Because the placement of most materiel will not take into consideration the direction of the extreme wind speeds, consider the shortest horizontal dimension of the materiel as the downwind dimension.

MIL-STD-810H
PART THREE

- a. **Highest Recorded.** The highest recognized worldwide maximum wind speed measured at a surface station is a 5-minute speed of 177 knots (204 mph), and a 1-second gust of 196 knots (226 mph) measured at Mt. Washington Observatory, New Hampshire, on 12 April 1934. The Observatory is 1915m (6280 ft) above MSL, and the anemometer was mounted at 12m (39 ft). However, this is an anomalous location, and such values should not be considered for this standard.

Tornado winds also are excluded from consideration because they are considered to be too localized. No wind measuring device has ever survived the full fury of a tornadic wind. Authorities have suggested that the winds could exceed 350 knots (403 mph).

A 152 knot (175 mph) gust at a height of 9.2m (30 ft) (corresponding to 139 knots (160 mph) at 3m (10 ft)) was recorded during a typhoon that passed over Iwo Jima AB, Volcano Islands in the Pacific Ocean in 1948. The maximum sustained wind is a 5-min speed of 131 knots (151 mph) measured at a height of 16.5m (54 ft) (corresponding to 119 knots (137 mph) when corrected to a 1-minute speed at 3m) at San Juan, Puerto Rico. These two extremes should not be considered as the highest winds that have occurred over a general area or region. Certainly, higher speeds have occurred, but have not been recorded due to their devastating damage.

The highest wind speeds affecting sizable areas occur within the typhoons that pass over the islands of the western North Pacific Ocean. Of these, Typhoon Nancy, during the period 11-12 September 1961, was the most intense typhoon ever observed by the Joint Typhoon Warning Center (Inception date for the JTWC was 1945). They reported maximum surface winds to be 185 knots (213 mph), estimated from air reconnaissance observations. For this standard, it is assumed that the highest sustained wind-speeds affecting a sizable area of military concern was the 185 knots (213 mph) (sustained for a duration of several minutes). The most probable 2-second gust to accompany this sustained wind is estimated to be 204 knots (235 mph).

- b. **Frequency of Occurrence.** The location having the highest 1-percent wind is Northern Scotland. Typical of the area is Stornoway where in the windiest month (December), the 1-, 5- and 10-percent high wind speeds are 43, 36 and 33 knots (49.5, 41.4, and 38 mph), respectively (1-min speeds at a 3m (10 ft) height). The most probable gusts that can be expected to accompany these 1-, 5- and 10-percent wind speeds, based on the shortest horizontal dimension of the materiel, are given in the following table:

Table XIII. Associated gusts (m/s (mph)).

Percent Extreme	1-min Steady m/s (mph)	Shortest Horizontal Dimension of Materiel (m (ft))					
		<0.6 (2)	1.5 (4.9)	3 (9.8)	8 (26)	15 (49)	30 (98.4)
1	22 (49.5)	32 (71.6)	59 (132)	56 (125.3)	53 (118.6)	50 (112)	48 (107.4)
5	19 (41.4)	27 (60.4)	49 (109.6)	47 (105)	44 (98.4)	42 (94)	40 (89.5)
10	17 (38)	25 (56)	45 (100.7)	43 (96.2)	40 (89.5)	38 (85)	36 (80.5)

Note: Most meteorological reports give wind speed in knots; 1 knot = 1.15 mph; 1 knot = 0.51 m/s.

The wind speeds in Table XIII are for a height of 3m (10 ft). Speeds can be estimated for other heights by using power law relationship

$$v_z = v_{3m} \left(\frac{z}{3m} \right)^P$$

where v_z is the velocity at the desired height, v_{3m} is the velocity at 3m, z is the desired height in meters, and P is an exponent that varies primarily with terrain and stability. MIL-STD-210B used P values of 0.125 for winds less than 50 kts (58 mph) and 0.08 for gusts and winds of at least 50 kts (58 mph). However, this resulted in circumstances where the steady speeds exceeded the gusts. Therefore, a compromise of $P = 0.10$

MIL-STD-810H
PART THREE

is recommended for converting these wind speeds and gusts to other heights up to 100m (328 ft). Reference to more detailed information is provided in Annex A.

c. Long-term Extremes.

The area having the highest winds in the world (excluding mountain peaks and tornado tracks) is in the typhoon belt of the western North Pacific Ocean. (This area ordinarily has relatively low wind speeds). Locations typical of the center of this belt are the Volcano Islands (for example, Iwo Jima) and Ryukyu Islands (for example, Okinawa). Of these locations, Naha, Okinawa (26°12'N, 127°39'E, station elevation 7m (23 ft) MSL) was found to have the highest annual extremes. Based on 19 years of data, long term extremes were computed. The mean of the highest annual 2-sec gusts is 84 knots (97 mph) with a standard deviation of 26.4 knots (30 mph). Applying these statistics in the theory of extremes, the 2-sec gusts that can be expected to occur at least once during 10, 30, and 60 yrs are 134, 154, and 167 kts (154, 177, and 192 mph) respectively. The most probable 1- min steady winds associated within these 2-sec gusts are 119, 140, and 156 kts (137, 161, and 180 mph) respectively. Gusts for various shortest horizontal dimensions of materiel are presented in the following table:

Table XIV. Associated gusts (m/s (mph)).

Period (yrs)	1-min Steady Speed m/s (mph)	Shortest Horizontal Distance of Materiel (m (ft))					
		<0.6 (2)	1.5 (4.9)	3 (9.8)	8 (26)	15 (49)	30 (98.4)
10	61 (136.5)	77 (172)	74 (166.5)	73 (163.3)	71 (158.8)	69 (154.3)	68 (152)
30	72 (161)	87 (194.6)	85 (190)	83 (185.7)	81 (181.2)	80 (179)	78 (174.5)
60	80 (179)	95 (212.5)	93 (208)	91 (203.6)	89 (199)	88 (196.9)	86 (192.4)

Note: Most meteorological reports give wind speed in knots; 1.15 mph = 1 knot; 1 m/s = 1.94 knot.

These wind speeds are for a height of 3m (10 ft). Speeds (and gusts) can be estimated for other heights up to 100m (328 ft) by using the power law relationship in paragraph 5.1.2b, with a value of 0.08 for P. This lower value for P is recommended because these extremely high wind speeds occur in open areas where winds decrease less rapidly with height.

5.2 Rain.

5.2.1 Intensities.

The world's highest rainfall intensities are in areas that experience the constant high humidity conditions of the basic climates, particularly Southeast Asia. The operational value is an instantaneous (1-minute) rate of 0.80 mm/min (0.03 inches per minute). Based on data from Southeast Asia, this is the value exceeded only 0.5 percent of the hours in the rainiest month. For certain classes of materiel (e.g., missiles, aircraft) that might be subject to erosion from the more extreme rainfall intensities, a design value of 1.80 mm/min (0.07 inches per minute), derived from the same area should be considered. This is the intensity that is exceeded only 0.1 percent of the hours in the most extreme month. Much higher rainfall intensities can occur, but they are normally of short duration and, usually are restricted to small areas. The highest rainfall intensity ever officially recorded is 31 mm/min (1.23 inches per minute) was in Unionville, MD.

- a. A nominal drop size spectrum for the 0.5 percent extreme is shown in Table XV.

Table XV. Rainfall intensities – Drop diameter range.

Number per m ³	0.5 – 1.4	1.5 – 2.4	2.5 – 3.4	3.5 – 4.4	4.5 – 5.4	5.5 – 6.4
	2626	342	45	6	1	<1

- b. The above rainfall intensities may be accompanied by intermittent winds up to 18 mps (60 fps). Higher wind speeds occur in hurricanes and typhoons (up to 45 mps or 148 fps), along with intense rain that falls almost horizontally penetrating cracks around doors, hatches, and other vertical openings.
- c. Rainfall is an important battlefield obscurant because it degrades the performance of the human eye and

MIL-STD-810H
PART THREE

some electro-optical sensors by attenuating electromagnetic radiation in the atmosphere. These effects are most closely related to rainfall intensities. However, rainfall intensities have a high positive correlation with mean annual precipitation, except in some mountainous areas on the windward sides of the continents. Areas with over 2032 mm (80 in) have high rainfall intensities throughout the year. Areas with less than 254 mm (10 in) have high rainfall intensities only a very small percentage of the time. Areas that have between 254 and 2032 mm (10 to 80 in) either have seasonally high intensities or less intense rainfall distributed throughout the year.

5.2.2 Rainfall rate.

The highest rates of rainfall occur when there is strong convection (rising currents of air) and available moisture. Thunderstorms and tropical cyclones (including hurricanes and typhoons), are systems that most commonly have these ingredients. Thunderstorms, that are relatively small and localized, produce the heaviest rainfalls over periods of a few hours or less.

Tropical cyclones are responsible for most of the extreme amounts for a few hours to a few days. Orographic precipitation, that is the result of moist air forced to ascend over topographic features, can also be quite heavy and can continue for long periods. Windward slopes of mountain ranges in the moist tropics generally have the highest monthly and annual amounts; they are also prone to very extreme amounts when affected by tropical storms.

- a. Highest Recorded. The world's greatest recorded 1-min rainfall is 31.2mm (1.23 in) at Unionville, Maryland, on 4 July 1956. This extreme occurred during an afternoon of intense thunderstorms. The total precipitation during the storm was 91.4mm (3.6 in). The drop size distribution associated with this rate is given in paragraph 5.2.2b below. (This 1-min rate is about twice as great as the next several candidates, leading one to doubt its validity).

The greatest rainfall from readily available records for about 1 hr is 305mm (12 in) that occurred within a 42 min period (7.25 mm/min) at Holt, MO, during a local intensification of a narrow squall line ahead of a surface cold front. The drop-size distribution associated with this rate is given in paragraph 5.2.2b below.

- (1) The world's greatest 12-hr rainfall is 135cm (53 in) on 28-29 February 1964 (average of 1.87 mm/min) at Belouve, La Reunion Island.
- (2) The world's greatest 24-hr rainfall is 188 cm (74 in) on 15-16 March 1952 (average of 1.31 mm/min) at Cilaos, La Reunion Island.
- (3) The world's greatest five-day rainfall is 430 cm (169 in) on 23-27 January 1980 at Commerson, La Reunion Island.

La Reunion Island is located in the Indian Ocean at approximately 21°S, 55°30'E. It is about 48 km by 64 km (30 by 40 miles) in extent and very mountainous, with steep slopes and narrow valleys. Sea surface temperature is highest during the tropical cyclone season, reaching 27°C (81°F) in March. The record-producing rainfalls at Cilaos and Commerson occurred during tropical cyclones as did, presumably, that at Belouve.

- b. Frequency of Occurrence. Operation of exposed materiel is affected by the instantaneous rate of rainfall. Heaviest rainfalls have the highest expectancy in tropical areas, especially over windward coasts and slopes. Unfortunately, little data are available on 1-min rates that are used to represent instantaneous rates. Total amounts, measured every 3 hrs or more, make up most of the climatological records. In order to determine 1-min rates on a large scale, a technique for obtaining intensities from readily available precipitation data was developed.

A statistical model in the form of regression equations for estimating 1-min precipitation intensities from available climatology, was developed using 1-min data obtained during special observation programs. Atlases of 1-min rates, based on the model, were used to determine areas in the world with the highest rates occurring 0.5, 0.1, and 0.01 percent of the time. Rainfall rates are presented for lower frequencies than other climatic elements because high rates are quite extensive in the tropics, and high rates can be a problem in many months of the year.

The highest rainfall rates occurring 0.5, 0.1, and 0.01 percent of the time were estimated to be 0.6, 1.4, and 2.8mm/min, respectively. These were based on data from two locations in northeast Brazil, Barro Do Corda and Teresina, and from Cherrapunji, India. These rates do not greatly exceed those occurring in many parts of the moist tropics, especially in Southeast Asia. The liquid water content for these rates is 1.6, 3.5, and 6.7 g/m³, respectively.

MIL-STD-810H
PART THREE

Drop-size distributions for these rates, and also the world record 1-min and 42-min rates in paragraph 5.2.2a were estimated from a gamma-function fit to drop-size distributions observed during heavy rain in tropical cyclones.

Table XVI. Raindrop concentrations per cubic meter.

Rate (mm/min)	Drop Diameter Range (mm)					
	0.5 to 1.4	1.5 to 2.4	2.5 to 3.4	3.5 to 4.4	4.5 to 5.4	5.5 to 6.4
0.6	1154	260	26	2	< 1	< 1
1.4	1608	520	77	8	< 1	< 1
2.8	2057	863	170	25	3	< 1
7.2	2779	1595	440	91	16	3
31.2	4121	3547	1514	487	135	34

- c. **Long-term Extremes.** Periods of intense rainfall for 1, 12, and 24 hours that would be expected to occur at least once in 10, 30, and 60 years, were derived from a statistical analysis of data from more than 200 locations around the world. This was used to develop regression equations to estimate rainfall extremes from climatic data that are widely available for most observation sites, since published data for 1, 12, and 24 hrs are limited. The highest rainfalls were found to occur in Southeast Asia, Burma, west to India and south to Indonesia.

The rain amounts for 1, 12, and 24 hrs given in Table XVII often occur with the passage of a tropical cyclone. Nominal temperature and wind speed associated with these storms are 24°C (75°F) and 64 kts (74 mph) for the 1-hr intensity, 50 kts (58 mph) for the 12-hr intensity, and 40 kts (46 mph) for the 24-hr intensity (for anemometer heights of 3m).

Table XVII. Long term extreme rainfall rates (cm/h).

Duration (hrs)	Rainfall Rate (cm/hr)		
	Period (yrs)		
	10	30	60
1	10	12	13
12	2.3	2.8	3.0
24	1.5	1.8	1.8

5.3 Snow.

Three aspects of snow are discussed in relation to materiel design. Falling snow also affects the performance of electro-optical systems because of the attenuation and degradation of electromagnetic radiation in the atmosphere.

- a. **Snowfall rate.** No operational extreme is given for rate of snowfall accumulation because conditions are more severe when snow is windblown (see paragraph 5.3b below). The greatest snowfall accumulation during a 24-hour period ever recorded in the United States, the snowier sections of which receive as much snow as any part of the world, was 1930 mm (76 inches), a rate of about 76 mm/hr (3 inches per hour). Crystal sizes of snow particles range from 0.05 to 20 mm diameter with a median range of 0.1 to 1.0 mm. Larger sizes are associated with temperatures near freezing and light winds.
- b. **Blowing snow.** Operational extremes for blowing snow are given in terms of horizontal mass flux of snow particles; that is, the mass of snow moving horizontally across a unit area per unit time. Mass flux decreases significantly with increasing height; highest fluxes are found below 0.05m (2 inches). Therefore, extremes of blowing snow are given for height intervals up to 10m (33 feet). Design values should be based on the height of the materiel. The horizontal mass fluxes for operational extremes, with a wind speed of 13 mps (44 fps) at a height above ground or snow surface of 3m (10 feet), are shown in Table XVIII.

MIL-STD-810H
PART THREE**Table XVIII. Horizontal mass fluxes for blowing snow.**

Height		Mass Flux	
feet	meters	lbs./ft./sec	kg/m ² /sec
33.0	10.0	0.45 x 10 ⁻³	2.2 x 10 ⁻³
25.0	7.5	0.68 x 10 ⁻³	3.3 x 10 ⁻³
16.0	5.0	0.82 x 10 ⁻³	4.0 x 10 ⁻³
8.2	2.5	1.4 x 10 ⁻³	6.9 x 10 ⁻³
3.3	1.0	3.3 x 10 ⁻³	16.0 x 10 ⁻³
2.5	0.75	4.5 x 10 ⁻³	22.0 x 10 ⁻³
1.6	0.5	6.6 x 10 ⁻³	32.0 x 10 ⁻³
0.82	0.25	14.0 x 10 ⁻³	66.0 x 10 ⁻³
0.33	0.1	41.0 x 10 ⁻³	200.0 x 10 ⁻³
0.16	0.05	109.0 x 10 ⁻³	530.0 x 10 ⁻³

When blown by strong winds, snow crystals are broken and abraded into roughly equal size grains with rounded or subangular corners. More particles occur in the size range of 0.02mm to 0.4mm, where the size is the effective diameter as $\sqrt{\text{length} \times \text{breadth}}$ in the plane of measurement. Smaller sizes tend to occur at lower temperatures.

Within the basic cold regions, the typical temperature range during periods of blowing snow is -10°C to -20°C (14°F to -4°F). Within the cold and severe cold regions, snowfall is common at temperatures between -23°C and -29°C (-10°F and -20°F). Blowing snow may occur at temperatures as low as -40°C (-40°F). Particle size decreases rapidly with height from the surface to 0.05m (1.6 ft), and gradually above this level. A typical distribution of blowing snow particle sizes applicable to extremes is given in the following table.

Table XIX. Typical distribution of blowing snow particle sizes.

	Effective Diameter (micrometers)												
	23 to 34	35 to 46	47 to 58	59 to 70	71 to 82	83 to 94	95 to 106	107 to 118	119 to 130	131 to 142	143 to 154	155 to 166	167 to 178
Percent	0.6	1.3	5.0	15	22	21	16	9.7	4.7	2.5	1.0	0.7	0.5

c. **Snowload.** A third important effect of snow is the structural load imposed by accumulated snow upon buildings, shelters, vehicles, or other relatively large military items. Snowload extremes are not applicable to operations; however, designers of the above materiel may wish to consider the following extremes that are for snowloads on the ground. Snowloads on military materiel would usually be less than on the nearby ground.

- (1) Portable materiel usually involves small items, such as tentage, that may be moved daily. This materiel generally will shed snow, but in instances where it does not, distortion will be noticeable and daily cleaning mandatory. The design criterion for this materiel is based on 24-hour snowfalls. The snowload value is 48.9 kg/m² (10 lbs/ft²), that is equivalent to a depth of 508 mm (20 inches) of snow with a specific gravity of 0.1.
- (2) Temporary materiel usually involves large items on which snow can collect, rigid shelters, portable hangars, etc., that can be cleared of snow between storms. This materiel will not sag much due to the snow loading, but may collapse when its limits are exceeded. The design criterion for this materiel is based on snowfalls associated with storms lasting longer than one day. The snowload value is 97.7 kg/m² (20 lbs/ft²), is equivalent to a snow depth of 1016 mm (40 inches) with a specific gravity of 0.1.
- (3) Semi-permanently installed materiel is usually demountable and not very mobile. Snow is not removed between snowfalls. The design criterion for this materiel is based on seasonal accumulation of snow. The snowload value is 235 kg/m² (48 lbs/ft²), that is equivalent to a snow depth of 2438 mm (96 inches) with a specific gravity of 0.1.

MIL-STD-810H
PART THREE

- (a) Highest Recorded. The values given in this section are for snow loads on the ground, not on shelters or materiel. Although snow loads on materiel are generally less than ground snow loads, the latter may be used as a guide in determining the maximum snow loads that are possible. Values, provided as kg/m^2 , can be converted to lbs/ft^2 by multiplying by 0.205.
- Portable Materiel. In mountainous areas 194 kg/m^2 ; in non-mountainous areas 137 kg/m^2 . These are based on the extreme 24-hour snowfalls that occurred at Silver Lake, Colorado (193 cm) in April 1921, and Barnes Corner, New York (137 cm) in January 1976, respectively.
 - Temporary Materiel. In mountainous areas, 484 kg/m^2 ; in non-mountainous areas 191 kg/m^2 . These are based on the extreme single-storm snowfalls exceeding 24 hours. They occurred at Mt Shasta, California (480 cm) in February 1959, and Watertown, New York (175 cm) in January 1922, respectively.
- (b) Semi-permanently Installed Materiel. In mountainous areas, 1155 kg/m^2 ; for non-mountainous areas, the record extreme is not available, but an extreme that is likely to occur one year in 30 is a snow load of 590 kg/m^2 . The estimate for mountainous areas was based on the greatest recorded depth, 1146cm (37.5 ft), that occurred at Tamarack, California in March 1911. The non-mountain value was based on a study of Canadian snowfall statistics.
- (c) Frequency of Occurrence. Not applicable because materiel should be designed to withstand, without collapse or severe damage, snow loads that are expected over long periods.
- (d) Long-term Extremes. Snow loads recommended for use in design would be expected to occur one year in ten at the worst non-mountainous areas in the world. They are based on data obtained for stations located in the United States and Canada. The values presented are based on ground snow loads from non-mountainous areas converted to loads on horizontal and exposed surfaces of the materiel over which the wind flow is unimpeded and unobstructed. Inclined surfaces need to support only as much snow as can accumulate on the slope involved.
- (e) Portable Materiel. 49 kg/m^2 . Based on a 24-hour snowfall to a depth of 51 cm (20 in) with a specific gravity of 0.1.
- (f) Temporary Materiel. 98 kg/m^2 . Based on a single-storm snow depth of 102 cm (40 in) with a specific gravity of 0.1.
- (g) Semi-permanently Installed Materiel. 246 kg/m^2 . Based on an estimated ground snowload of 393 kg/m^2 (80 lb/ft^2) one year in 10 (10 percent probability each year), and a conversion factor of 0.625 for determining materiel loads from ground loads.

MIL-STD-810H
PART THREE

- d. Highest Recorded. Highest recorded horizontal mass fluxes (saturation conditions) at heights ranging from 0.05 to 10m, accompanied by a wind speed of 45 knots (52 mph) at the 3m level are:

Table XX. Highest recorded snow mass fluxes.

Height		Mass Flux	
(m)	(ft)	(g/m ² sec)	(lb/ft ² sec)
10	33	310	63x10 ⁻³
7.5	25	320	66
5.0	16	330	68
2.5	8.2	380	78
0.75	2.5	630	129
0.50	1.6	800	164
0.25	0.82	1600	328
0.10	0.33	3000	614
0.05	0.16	6200	1270

- e. Frequency of Occurrence. The horizontal mass fluxes, one percent value, at heights ranging from 0.05 to 10 m, driven by wind speeds of 25 knots (29 mph) at the 3m (10 ft) level (the 1-percent wind speed in central Canada during January) are:

Data for 5- and 10-percent values are not available. Recommend the above values be applied to any materiel that is susceptible to the effects of blowing snow. The typical particle-size distribution and associated temperature are provided in paragraph 5.3b.

- f. Long-Term Extremes. Not applicable for this climatic element.

5.4 Ice.

5.4.1 Icing phenomena.

Icing phenomena include glaze (freezing rain), hoarfrost, and rime that cause problems of ice accretion on aircraft and other materiel, and ice fog that interferes with visibility. Although reliable and systematic data on ice accumulation are scarce, fairly large areas of the United States and Europe can expect to endure seven or more ice storms per year. The effects of the storms may last from a few hours to several days. In the same areas, probably one storm per year on the average is severe enough to cause some damage. In perhaps one year out of two or three, ice accumulation will probably be a half-inch or more. Therefore, if all-weather operation of materiel is desired within the areas where icing may occur, the operational design value should be for one-half inch of glaze with specific gravity of 0.9. This includes the colder sections within the basic design type, and all of the cold and severe cold areas. If materiel failure during the time of icing can be tolerated, the question of withstanding more severe storms without permanent damage becomes important. For withstanding, the values are as follows:

- 76 mm (3 inches) glaze, specific gravity 0.9.
- 152 mm (6 inches) glaze and rime mixed, specific gravity 0.5.
- 152 mm (6 inches) rime, specific gravity 0.6.
- 152 mm (6 inches) rime near the surface increasing linearly to 508mm (20 inches) at 122m (400 feet), specific gravity 0.2.

- a. Deposits of hoarfrost, the only type of ice accretion that occurs when air temperatures are well below 0°C (32°F), may be several inches thick but will have a specific gravity of less than 0.2.
- b. Ice fog consists of suspended ice crystals averaging 5 to 20 micrometers in diameter. In areas where sufficient water vapor is present, ice fog occurs mainly at temperatures below -37°C (-35°F). Ice fog may be very dense, limiting visibility to a few feet. This condition is often locally induced by the operation of motor vehicles, power plants, weapon systems. It is usually high in concentration of contaminants from

MIL-STD-810H
PART THREE

the burning of hydrocarbon fuels and explosive fuels. It affects the performance of electro-optical systems because of its attenuation and degradation of electromagnetic radiation in the atmosphere.

5.4.2 Ice accretion.

Ice accretion can be a major destructive force to structures, such as towers, located in middle and high latitudes just about anywhere in the world. Concurrent or subsequent strong winds may be the critical force in damaging materiel loaded with ice. There are three basic kinds of ice formed by accretion in the atmosphere: glaze, hard rime, and soft rime.

Glaze occurs when rain (sometimes drizzle) freezes on objects; it is clear and nearly as dense as pure ice. Hard rime is less transparent than glaze because of air trapped in the ice. The density with respect to water (specific gravity) varies from 0.6 to 0.9. It is usually the result of freezing drizzle, but may occur from exposure to supercooled cloud droplets during high winds with the temperature near freezing. Soft rime ice occurs when supercooled clouds or fog droplets freeze upon impact with surfaces colder than 0°C (32°F). It is opaque with a specific gravity of 0.2 to 0.5. It occurs most commonly on hills or mountaintops exposed to clouds at freezing temperatures.

Unfortunately, quantitative records of glaze and rime are not available because icing has not been routinely observed at operational weather stations. In order to determine reasonable values of ice and wind loading, it was necessary to study case histories of major ice storms, when structures have failed due to the strain of combined ice and wind loading.

- a. Highest Recorded. Not available.
- b. Frequency of Occurrence. Except for locations such as mountaintops exposed to supercooled clouds, the frequency of occurrence is normally quite low. Materiel exposed to the environment should be designed to survive the extreme accumulation of ice and concurrent wind expected to occur once over a period of years.
- c. Long-Term Extremes. These values are estimated to occur once in ten years at icing-prone locations such as eastern Labrador, Canada. More severe conditions will be found on cloud-immersed mountain peaks during periods of continuous passage of supercooled water clouds (specific information will be required for materiel designed especially for such installations). Strong winds are frequently associated with icing, occurring during its formation or after it has formed but before melting. Forces of such winds must be added to forces due to ice accretion as part of the stress in design for ice accretion.

Values of ice provided in paragraph 5.4.1 above are thicknesses extending horizontally into the wind. They apply to structures extending up to heights of 125m (410 ft). Associated wind loading can be considered as gusts of 100 knots (115 mph) at about 10m (33 ft), increasing to 123 knots (142 mph) at 125m (410 ft/min). Use independent design considerations for the value of each of the three types of icing below:

5.5 Atmospheric pressure. Atmospheric pressure usually is not considered in the design and testing of military materiel. Ambient pressure, however, may be important for a few types of materiel, for example, items that require oxygen for combustion and sealed units, that might explode or collapse under abnormally low or high pressure.

- a. High pressure. The operational extreme high pressure is 108 kPa (31.89 inches).
- b. Low pressure. The operational extreme low pressure is estimated to be 50.8 kPa (15.00 inches) at 4,572m (15,000 feet), the highest elevation at which Army materiel is likely to be used. At sea level, the operational extreme is 87.7 kPa (25.90 inches).

5.6 Ozone concentration.

See MIL-HDBK-310, paragraph 5.1.20.

5.7 Sand and dust.

“Sand” and “dust” are terms used to designate small particles of matter, usually of mineral origin. A distinction is often made between sand and dust on the basis of size, but there are no generally accepted specific size limits for the two kinds of particles. For most military applications, it is important to distinguish between the smaller particles (dust) and the larger particles (sand) because of their primary effects on materiel. Airborne dust is primarily damaging because of its penetration and subsequent possible damage; airborne sand is primarily damaging because of its erosion and abrasion effects on materiel. Particles vary in diameter from 0.1 to 1,000 micrometers (3.94×10^{-6} inches to 3.94×10^{-2} inches), but most airborne particles are less than 74 micrometers (2.91×10^{-3} inches). Dust can penetrate small openings, causing undue wear to moving parts, and interfere with electrical contacts. Hardness also varies widely (from 1 to 9 on the Mohs scale) depending largely on mineral composition. Blowing sand, that may be too large to penetrate the smaller openings, can erode and abrade the outside of materiel. Sand and dust present in the air affect

MIL-STD-810H
PART THREE

the performance of electro-optical systems because of their attenuation and degradation of electromagnetic radiation in the atmosphere. Greatest particle concentrations are found near helicopters hovering over dry, loose surfaces. Secondary concentrations are found near ground vehicles operating on unpaved surfaces. Lesser concentrations are associated with natural dust storms, although the areal extent of such storms may be substantial.

- a. Highest Recorded. Too few reliable and systematic measurements have been made to establish an extreme value. However, concentrations as high as 6.00 g/m² (particles smaller than 70 micrometers) have been made inside the engine compartment of a tank moving over a very dusty surface.
- b. Frequency of Occurrence. Since this is not an observed climatic element, and is most often mechanically created, frequencies of occurrence are not applicable. Three concentration levels are provided; selection of the appropriate one depends on intended use of the materiel under consideration. Items likely to be used in close proximity to aircraft operating over unpaved surfaces should be designed for particle concentrations of about 2.19 g/m³ in multidirectional strong winds (downwash from helicopters rotors). Such particles range in size up to 500 μm in diameter. Items never used in close proximity to operating aircraft, but which may be found near operating surface vehicles, should be designed for particle concentrations of 1.06 g/m³ with wind speeds up to 18 mps at a height of 3m. Particle sizes will range from less than 74 μm in diameter to 1000μm, with the bulk of the particles ranging in size between 74 and 350μm. These two categories are likely to include most military items. However, items that are assured of being subjected to ONLY natural conditions should be designed for particle concentrations of 0.177 g/m³ with wind speeds of 18 m/s at a height of 3m (10 ft). Under these conditions, the bulk of the particle sizes are likely to be less than 150 μm, except that some larger particles (up to 1000 μm) may be in motion within several feet above the ground. In all categories, temperatures are typically above 21°C (70°F) and relative humidities are less than 30 percent. For testing purposes, particle sizes up to 150 μm should be used if the primary concern is with the penetration of fine particles. If the abrasion effect of blowing sand is the primary concern, particle sizes up to 1000 μm should be used, but the bulk of the particles should be between 150 and 500 μm. Many items, such as rifles, vehicles, and helicopters, may be exposed to fine particles that can penetrate the space between moving parts.

5.8 Dust as a natural obscurant.

Airborne dust scatters visible, near-IR, and thermal radiation. The scattering shows little spectral sensitivity in the visible and near-IR bands because of the relatively broad particle size distribution. Transmittance losses in the thermal bands are slightly lower than in the visible region and may show some spectral dependence. .

Airborne dust and sand may be either part of a constant background aerosol or a dust cloud that may persist in duration from less than an hour to several days. Dust storms (visibility < 1km due to dust) are common phenomena over many parts of the world, and in some areas they occur with great frequency (see Table XXI). The dust fall from these storms has been estimated to extend over as much as 575,000 to 800,000 km². Major regions where dust originates are the Sahara, the southern coast of the Mediterranean Sea, the northeast Sudan, the Arabian Peninsula, the lower Volga and North Caucasus in the former USSR, the pampas of Argentina, Afghanistan, and the western Great Plains of the US.

Worldwide dust storm frequency is at a maximum in areas where the annual rainfall is between 100 and 200 mm (3.9 and 7.9 in); in such locations the mean annual frequency is about nine days per year.

MIL-STD-810H
PART THREE

Table XXI. Number of days per year with dust storms (visibility < 1 km).

Location	Days Per Year
Abadan, Iran	13
New Delhi, India	8
Ganganagar, India	17
Paoting, China	19
Kantse, China	35
Hami, China	33
Tarim Basin, China	100 to 174
Baghdad, Iraq	21
Basra, Iraq	15
Shaibah, Iraq	38
Diwaniyah, Iraq	36
Aqaba, Jordan	11
Nguru, Nigeria	26
Mexico City, Mexico	68
Kazakhstan, (former) USSR	60
Repetek, (former) USSR	60
Beersheva, Israel	27
Kuwait Airport, Kuwait	27
Abu Kamal, Syria	10
Mersa Matruh, Egypt	10
Riyadh, Saudi Arabia	13
Dharan, Saudi Arabia	11
Khartoum, Sudan	24

Size distributions of dust usually fall into three categories. The first category, between 1 and 10 μm in radius, appears to be characteristic of soil-derived aerosols under all conditions. This distribution is generally present and is not related to the size distribution of soil over which measurements are taken. The second category, occurring between 10 and 100 μm , appears to be characteristic of the parent soil size distribution only under conditions of moderate-to-heavy dust loading in the atmosphere. The third category, centered between 0.02 and 0.5 μm , generally does not appear related to the other (soil) modes in composition or origin; rather, it appears to be characteristic of a background aerosol and may be identified with the accumulation mode for secondary aerosols observed in urban measurements.

MIL-STD-810H
PART THREE**5.9 Freeze-thaw cycles.**

A freeze-thaw cycle occurs at a specific site on any day the temperature crosses the freezing mark. It is possible for more than one freeze-thaw cycle to occur at any site during a 24-hour period, however, because of normal control of the daily temperature cycle by the solar cycle, this is not a common occurrence. Therefore, freeze-thaw cycles are described by the number of days in which they occur.

- a. Freeze-thaw is an important consideration in the design of many types of military materiel. Consider it in the design of all materiel to be used in the areas where freeze-thaw cycles occur. The effects on materiel are caused by alternating expansion and contraction of different materials and, especially, the change of state that water experiences during the freezing and thawing processes. The freezing and thawing of water in exposed components of materiel can create great internal stress and damage. Freeze-thaw is of greatest potential concern as a factor affecting materiel in areas where abundant moisture is present (so that condensation and precipitation are common) immediately before or during the occurrence of the freeze-thaw cycle. The maximum number of freeze-thaw days in non-mountainous areas occurs in the mid-latitudes. The mid-latitudes also have a great variance in average number of freeze-thaw days. In general, sites that have the most months with mean monthly temperatures at or near 0°C (32°F) will have the greatest annual number of freeze-thaw days in non-mountainous areas. However, materiel should be designed to withstand at least 20 cycles during the most severe month, with concurrent dewpoints of -2°C to 2 C (28°F to 36°F), a trace or more precipitation on the day of the cycle, and humidities tending toward saturation.
- b. In tropical mountains at high elevations, freeze-thaw cycles 337 days annually, and 31 days per month have been recorded. Elsewhere, a maximum of 31 days in one month also have been recorded.
- c. Due to the nature of this climatic condition, frequency of occurrence expressed as a percent does not apply. An occurrence of 20 cycles during the worst month is recommended. This would occur in low-level, mid-latitude areas such as Germany.
- d. Operational values are not appropriate for this element. However, materiel should be designed to withstand at least 20 cycles during the most severe month, with concurrent dewpoints of -2°C to 2 C (28°F to 36°F), a trace or more precipitation on the day of the cycle, and humidities tending toward saturation.

5.9.1 Basic cold-wet cycle.

Note: Although details for the cold-wet cycle are not included, the following general information provides guidance. This cycle was developed by the Corps of Engineers, but was never adopted by the US Army.

Basic cold-wet conditions occur throughout the colder, humid sections of the basic (regional) design type adjoining the areas of basic cold conditions. Cold-wet conditions, as defined here, may occur in any part of the basic type that regularly experiences freezing and thawing on a given day; however the conditions are found most frequently in Western Europe, the central United States, and northeastern Asia (China and Japan). In the Southern Hemisphere, cold-wet conditions occur only at moderately high elevations except in South America where they are found in Argentina and Chile south of 40° latitude.

MIL-STD-810H
PART THREE

Table XXII. Cold-wet daily cycle of temperature, humidity, and solar radiation.

Local Time	OPERATIONAL CONDITIONS (Natural Environment)						STORAGE AND TRANSIT CONDITIONS			
	Ambient Air Temperature		Solar Radiation		Relative Humidity	Dewpoint Temperature		Induced Air Temperature		Relative Humidity
	°C	°F	W/m ²	Bph	Percent	°C	°F	°C	°F	Percent
0100	-3	26	Negligible During Low Temperature Periods		Tending Towards Saturation	-3	26	-4	25	Tending Toward Saturation
0200	-3	26				-3	26	-4	24	
0300	-4	25				-4	25	-5	23	
0400	-4	25				-4	25	-5	23	
0500	-4	25				-4	25	-5	23	
0600	-4	25				-4	25	-5	23	
0700	-3	26				-3	26	-4	24	
0800	-2	28				-2	28	-3	26	
0900	-1	30				-1	30	-1	29	
1000	0	32				0	32	0	32	
1100	1	33				1	33	1	34	
1200	1	34				1	33	2	36	
1300	2	35				1	34	3	37	
1400	2	35				1	34	3	37	
1500	2	35				1	34	3	37	
1600	1	34				1	33	2	36	
1700	1	33				1	33	1	34	
1800	0	32				0	32	1	33	
1900	-1	30				-1	30	0	32	
2000	-2	29				-2	29	-1	30	
2100	-2	28				-2	28	-2	29	
2200	-3	27				-3	27	-2	28	
2300	-3	27				-3	27	-3	27	
2400	-3	26				-3	26	-3	26	

5.10 Microbial growth (fungus / mould).

Method 508.6 includes a list of fungus species typically used for US applications.

Although not specifically an “environmental element,” and as previously stated (paragraph 2.2.2), microbial deterioration is a function of temperature and humidity and is an inseparable condition of hot humid tropics and the mid-latitudes. Consider microbial deterioration in the design of all standard general-purpose materiel. NATO documentation provides an additional list as shown in Table XXIII below.

MIL-STD-810H
PART THREE**Table XXIII. European test fungus species.**

Fungus	Fungus Sources Identification No.		Materials affected
	USDA ^{1/}	ATCC ^{2/}	
Aspergillus niger	QM 458	ATCC 6275	Textiles, vinyl, conformal coatings, insulation, adhesives, etc. Resistant to tanning salts and copper
Aspergillus terreus	QM 82j	ATCC 10690	Haversack, paperboard, paper, plastics
Paecilomyces variotii	QM 6764	IAM 5001 ^{3/} ATCC 18502	Plastics, leather, textiles
Penicillium funiculosum		ATCC 36839 IAM 7013 ^{4/}	Textiles, plastics, cotton fabric, polymers, automotive components such as gaskets, distributors, cables, hoses, PVC, airborne equipment such as breakers, solenoids, switches, remote transmission accessories
Penicillium ochro-chloron	QM 477	ATCC 9112	Plastics, textiles
Scopulariopsis brevicaulis		ATCC 36840	Rubber
Trichoderma virens (ATCC 9645) (Gliocladium virens IAM 5061)	QM 365	ATCC 9645 IAM 5061 ^{4/}	Plastics, textiles, packing materials

5.11 Hail.

Hail occurs too infrequently to warrant specification of an operational extreme. When hail-caused materiel failure would endanger life or limb, designers should consider the possibility of encountering hailstones up to 51 mm (2 inches) in diameter. The largest hailstone ever recorded measured 47.6 cm (18.75 inches) in diameter (see Annex A, Table A-II).

5.12 Combined environmental effects.

The climatic design types in this Section are based primarily on temperature extremes, and secondly on humidity extremes. The climatic elements discussed in paragraph 3.5, however, may interact concurrently with temperature and humidity and with each other to produce effects on materiel either different or more severe than the sum of the effects caused by the separate elements acting independently. These are known as combined or synergistic environmental effects. The fact that these synergistic effects exist is one of the prime arguments for conducting field tests, because it is extremely difficult or impossible to reproduce the interacting environmental factors concurrently in a test chamber.

^{1/} US. Department of Agriculture, Northern Regional Research Center, ARS Culture Collection, 1815 North University Street, Peoria, IL 61604.

^{2/} American Type Culture Collection (ATCC), 10801 University Blvd, Manassas, VA 20110-2209.

^{4/} Institute of Applied Microbiology (IAM), University of Tokyo, Tokyo, Japan
(All suppliers may distribute the fungus in a lyophilized state or on agar slants.)

MIL-STD-810H
PART THREE

5.13 High elevations and upper air conditions.

- a. For materiel subject to transport through high mountain passes, the temperatures and pressures for elevations as high as 4,572 meters (15,000 feet) apply.
- b. For materiel subject to shipment by air (elevations as high as 15,240 meters or 50,000 feet), the low air pressure and temperature shown below could result from failure of cabin pressure and temperature regulation.

Table XXIV. Low air pressure and temperature at elevation.

Height or Elevation		Pressure	Temperature	
Meters	Feet	Kilopascals (kPa)	°C	°F
3048	10,000	66	-41	-42
4572	15,000	52	-47	-53
6096	20,000	41	-56	-68
9144	30,000	25.5	-66	-87
12192	40,000	16	-72	-98
15240	50,000	10	-76	-105

6. REFERENCED / RELATED DOCUMENTS.

6.1 Referenced documents.

- a. MIL-HDBK-310, Global Climatic Data for Developing Military Products, 23 June 1997.
- b. Environmental Standards for Materiel Design Group of the AirLand Battlefield Environment Executive (ALBE) Committee (1987), "Environmental Factors and Standards for Atmospheric Obscurants, Climate, and Terrain," Washington, D.C.
- c. AR 70-38, Research, Development, Test and Evaluation of Materiel for Extreme Climatic Conditions, 1 August 1979; [Army Forms and Publications Website](#).
- d. AMCP 706-115, Engineering Design Handbook, Environmental Series, Part 1, Basic Environmental Concepts, July 1974, DTIC Accession Number AD0784999.
- e. AMCP 706-116, Engineering Design Handbook, Environmental Series, Part 2, Natural Environmental Factors, April 1975, DTIC Accession Number ADA012648.
- f. AMCP 706-117, Engineering Design Handbook, Environmental Series, Part 3, Induced Environmental Factors, January 1976, DTIC Accession Number ADA023512.
- g. AMCP 706-118, Engineering Design Handbook, Environmental Series, Part 4, Life Cycle Environments, March 1975, DTIC Accession Number ADA015179.
- h. AMCP 706-119, Engineering Design Handbook, Environmental Series, Part 4, Life Cycle Environments, July 1975, DTIC Accession Number ADA015180.
- i. Krause, P.F. and K.L. Flood. 1997. Weather and Climate Extremes (Technical Report TEC-0099). Alexandria, VA: U.S. Army Topographic Engineering Center; [Topographic Engineering Center Website](#).
- j. MIL-STD-210B, Climatic Information to Determine Design and Test Requirements for Military Systems and Equipment (S/S By MIL-HDBK-310)

6.2 Related documents.

- a. NATO STANAG 4370, AECTP 230.
- b. NASA-HDBK-1001, Terrestrial Environment (Climatic) Criteria Guidelines for Use in Aerospace Vehicle Development, 11 August 2000.
- c. Egbert, Herbert W. "The History and Rationale of MIL-STD-810 (Edition 2)," December 2009; Institute of Environmental Sciences and Technology, Arlington Place One, 2340 S. Arlington Heights Road, Suite 100, Arlington Heights, IL 60005-4516.

(Copies of Department of Defense Specifications, Standards, and Handbooks, and International Standardization Agreements are available online at <https://assist.dla.mil>.)

MIL-STD-810H
PART THREE

Requests for other defense-related publications may be directed to The Defense Technical Information Center (DTIC), ATTN: DTIC-BR, Suite 0944, 8725 John J. Kingman Road, Fort Belvoir VA 22060-6218, 1-800-225-3842 (Assistance--selection 3, option 2), <http://stinet.dtic mil/info/s-stinet.html>; and the National Technical Information Service (NTIS), Springfield VA 22161, 1-800-553-NTIS (6847), <http://www ntis.gov/>.

MIL-STD-810H
PART THREE ANNEX A

PART THREE ANNEX A

WEATHER AND CLIMATIC EXTREMES – A Brief Summary

1. INTRODUCTION.

This Annex attempts to provide reference information related to worldwide and regionalized climatic extremes. There are two basic sources for this information, MIL-HDBK-310, and “Weather and Climatic Extremes.” Much of the information is captured in Section III of this document. The information in this Annex is not intended to be used as design or test data, but rather to provide guidance for consideration when developing Life Cycle Environmental Profiles (LCEPs).

2. MIL-HDBK-310.

MIL-HDBK-310, “Global Climatic Data for Developing Military Products,” includes extensive information regarding extreme natural environments. Consult MIL-HDBK-310 directly for more specific details.

The following data table was extracted from a publication by Dr. Paul Krause and Ms. Kathleen Flood of the Army Topographic Engineering Center. The publication is: Krause, P.F. and K.L. Flood. 1997. Weather and Climate Extremes (Technical Report TEC-0099). Alexandria, VA: U.S. Army Topographic Engineering Center.

Table A-I. Weather & Climatic Extremes – Brief Summary.

Temperature Extremes			
Lowest	°C (°F)	Location	Date
North America (excluding Greenland)	-63 (-81.4)	Snag, Yukon Territory	3 February 1947
US Coolest Summer Average	2.2 (36)	Barrow, AK	1941-1970
US Lowest Annual Mean	-12.8 (9)	Barrow, AK	1941-1970
US	-62.1 (-79.8)	Prospect Creek, AK	23 January 1971
US (excluding Alaska)	-56.5 (-69.7)	Rogers Pass, MT	20 January 1954
US Coldest Winter Average	-26.7 (-16)	Barter Island, AK	1941-1970
CA Lowest Annual Mean	-19.4 (-3)	Eureka, NW Territories	1947-1980
North America - Mean (Month) (excluding Greenland)	-47.8 (-54)	Eureka, NW Territories	February 1979
Greenland	-66.1 (-87)	Northice	9 January 1954
Europe	-55 (-67)	Ust’Shchugor, Russia	15 Year Period
Northern Hemisphere	-67.8 (-90)	Verkhoyansk & Oimekon, Russia	5 & 7 Feb 1892, and 6 Feb 1933
Africa	-23.9 (-11)	Ifrane, Morocco	11 February 1935
South America	32.8 (-27)	Sarmiento, Argentina	1 June 1907
Australia	-23 (-9.4)	Charlotte Pass, New South Wales	29 June 1994
Antarctica Mean Monthly	-73.2 (-99.8)	Plateau Station	July 1968
Antarctica Annual Mean	-57.2 (-71)	Sovietskaya	1957 & 1958
World	-88.9 (-128)	Vostok, Antarctica	21 July 1983

MIL-STD-810H
PART THREE ANNEX A

Table A-I. Weather & Climatic Extremes – Brief Summary – continued.

Temperature Extremes			
Highest	°C (°F)	Location	Date
US Winter Average	22.8 (73)	Honolulu, HI	1941 to 1970
Western Hemisphere	56.7 (134)	Greenland Ranch, CA	10 July 1913
Western Hemisphere Summer Average	37 (98)	Death Valley, CA	1941-1970
CA	45 (113)	Midale & Yellow Grass, Saskatchewan	5 July 1937
Europe	50 (122)	Seville, Spain	4 August 1881
World	56.7 (134)	Greenland Ranch, CA	10 July 1913
Asia	53.9 (129)	Tirat Tsvi, Israel	21 June 1942
World Annual Mean	34.4 (94)	Dallol, Ethiopia	Oct 1960 to Nov 1966
Australia	50.7 (123.3)	Oodnadatta, South Australia	2 Jan 1960
South America	48.9 (120)	Rivadavia, Argentina	11 December 1905
South Pole	-13.6 (7.5)	South Pole	27 December 1978
Antarctica	15 (59)	Vanda Station	5 January 1974
Miscellaneous			
US Largest 24-hour Temperature Fall	56 (100)	Browning, MT	23 & 24 January 1916
Western Hemisphere - Difference Between Lowest & Highest Recorded Temperatures	98.3 (177)	Mayo, Yukon Territory, CA	Unknown
US Largest 2-minute Temperature Rise	27.2 (49)	Spearfish, SD	22 January 1943
Eastern Hemisphere - Difference Between Lowest & Highest Recorded Temperatures	101.8 (183.2)	Verkhoyansk, Russia	Unknown
Mean Annual Temperature Range	81.1 (146)	Eastern Sayan Region, Russia	Unknown
Australia Longest Hot Spell	=/> 37.8 (100)	Marble Bar	30 October 1923 to 7 April 1924 (162 consecutive days)

MIL-STD-810H
PART THREE ANNEX A

Table A-II Precipitation extremes.

Greatest	Cm (in)	Location	Date
Possibly World 1-Minute Rainfall	3.12 (1.5)	Barot, Guadeloupe, West Indies	26 November 1970
World 1-Minute Rainfall	3.1 (1.23)	Unionville, MD	4 July 1956
World 20-Minute Rainfall	20.6 (8.10)	Curtea-de-Arges, Romania	7 July 1889
World 42-Minute Rainfall	30.5 (12)	Holt, MO	23 June 1947
Possibly World 60-Minute Rainfall	41.1 (15.78)	Muduocaidang, Nei Monggol, China	1 August 1977
World 12-Hour Rainfall	117 (46)	Grand Ilet, La R'eunion Island	26 January 1980
Canada 24-Hour Rainfall	49 (19.3)	Ucluelet Brynnoir Mines, BC	6 October 1967
US 24-Hour Rainfall	109 (43)	Alvin, TX	25-26 July 1979
Northern Hemisphere 24-Hour Rainfall	125 (49.2)	Paishih, Taiwan	10-11 September 1963
Australia 24-Hour Rainfall	114 (44.9)	Bellenden Ker, Queensland	4 January 1979
World 24-Hour Rainfall	182.5 (72)	Foc-Foc, La R'eunion Island	7-8 January 1966
World 5-Day Rainfall	430 (169.3)	Commerson, La Réunion Island	23-28 January 1980
World 1-Month Rainfall	930 (366)	Cherrapunji, India	July 1861
US Rainfall (12-Month)	1877 (739)	Kukui, Maui, HI	December 1981 to December 1982
World Rainfall (12-Month)	2647 (1042)	Cherrapunji, India	August 1860 to July 1861
North America Average Yearly Precipitation	650 (256)	Henderson Lake, British Columbia, CA	14-year Period
Australia Average Yearly Precipitation	864 (340.16)	Bellenden Ker, Queensland	9-year Period
South America Average Yearly Precipitation	899 (354)	Quibdo, Columbia	1931 to 1946
Africa Average Yearly Precipitation	1029 (405)	Debundscha, Cameroon	32-year Period
Europe Average Yearly Precipitation	465 (183)	Crkvice (former Yugoslavia)	22-year Period
US (& Possibly World) Average Yearly Precipitation	1168 (460)	Mount Waialeale, Kauai, HI	1931 to 1960
Asia (& Possibly World) Average Yearly Precipitation	1187.3 (467.4)	Mawsynram, India	1941 to 1979
SA & Possibly World Average Yearly Precipitation	1330 (523.6)	Lloro, Columbia	1932 to 1960

MIL-STD-810H
PART THREE ANNEX A

Table A-II Precipitation extremes – continued.

Snowfall	Cm (in)	Location	Date
France	172 (67.7)	Bessans	5-6 April 1969
North America 24-hour	193 (76)	Silver Lake, CO	14-15 April 1921
US Extreme Event	195.6 (77) (Not Official)	Montague Township, NY	11-12 January 1997
North America – One Storm	480 (189)	Mt Shasta Ski Bowl, CA	13-19 February 1959
North America – One Season	2896 (1140)	Mt Baker Ski Area, WA	1998 to 1999
Canada – One Season	2446.5 (963)	Revelstoke, Mt Copeland, BC	1971-1972
North America – Depth of Snow on Ground	1145.5 (451)	Tamarack, CA	11 March 1911
Lowest	Cm (in)	Location	Date
North America Average Yearly Precipitation	3 (1.2)	Bataques, Mexico	14-year Period
Western Hemisphere Average Yearly Precipitation	4.1 (1.63)	Death Valley, CA	1911 to 1953
Europe Average Yearly Precipitation	16.3 (6.4)	Astrakhan, Russia	25-year Period
Africa Average Yearly Precipitation	<0.25 (<0.1)	Wadi Halfa, Sudan	39-year Period
Asia Average Yearly Precipitation	4.6 (1.8)	Aden, South Yemen	50-year Period
Australia Average Yearly Precipitation	10 (4.05)	Troudaninna, South Australia	42-year Period
World Average Yearly Precipitation	0.08 (0.03)	Arica, Chile	59-year Period
Hailstones	Size	Location	Date
Canada – Heaviest	290 g (10.23)	Cedoux, Saskatchewan	27 August 1973
US – Largest Circumference	47.6 cm (18.75 in)	Aurora, Nebraska	22 June 2003
World – Heaviest	1.02 kg (2.25 lb)	Gopalganj District, Bangladesh	14 April 1986
Miscellaneous	Unit	Location	Date
US – Longest Dry Period	767 Days	Bagdad, CA	3 October 1912 to 8 November 1914
Years Without Rain	>14 Consecutive	Arica, Chile	October 1903 to January 1918
Greatest Average Number of Days Per Year With Rain	325	Bahia Felix, Chile	
Africa – Greatest Average Variability of Annual Precipitation	191 cm (75 cm)	Debundscha, Cameroon	
Relative Variability of Annual Precipitation	94 percent	Themed, Israel	1921 to 1947
Relative Variability of Annual Precipitation	108 percent	Lhasa, Tibet	1935 to 1939

MIL-STD-810H
PART THREE ANNEX A



Figure A-2. Precipitation extremes.

Compiled by
 Engineer Research and Development Center
 U.S. Army Topographic Engineering Center
 Alexandria, Virginia
 22315-3864
 for "Weather and Climate Extremes", 1997
 [Extremes updated through January, 2003]

MIL-STD-810H
PART THREE ANNEX A

Table A-III. Miscellaneous extremes.

Sea-Level Air Pressure	Mbar (in.)	Location	Date
North America - Highest	1067.7 (31.85)	Northway, AK	31 January 1989
World – Highest	1085.6 (32.61)	Tosontsengel, Mongolia	19 December 2001
North America – Lowest	892.3 (26.35)	Matecumbe Key, FL	2 September 1935
World – Lowest	870 (25.69)	Estimated in Eye of Typhoon Tip in area of 17°N 138°E	1`2 October 1979
Wind	Mph (kph)	Location	Date
Peak Gust	306 (190)	Miyakojima Island, Ryukyu Islands	5 September 1966
Mean Speed – 24 Hours	174 (108)	Port Martin, Antarctica	21-22 March 1951
Mean Speed – 24 Hours	206 (128)	Mt Washington, NH	11-12 April 1934
Mean Speed – Month	65 (105)	Port Martin, Antarctica	March 1951
Mean Speed – Month	113 (70)	Mt Washington, NH	February 1939
Highest Average Annual Speed	56 (35)	Mt Washington, NH	1934 to 1983
World Highest Surface – 5 Minute Speed	303 (188)	Mt Washington, NH	12 April 1934
World Highest Surface – Peak	372 (231)	Mt Washington, NH	12 April 1934
Canada – Maximum Hourly Speed	201 (125)	Cape Hopes Advance, Quebec	18 November 1931
Greenland - Peak Gust	333 (207)	Thule	8 March 1972
Miscellaneous	Units	Location	Date
Canada – Highest Frequency of Days With Thunderstorms	34 Per Year (Average)	Windsor, Ontario	
North America - Highest Frequency of Days With Thunderstorms	100 Per Year (Average)	Tampa International Airport, FL	
US Greatest Average Number of Days With Hailstorms	9.4 Per Season	Cheyenne, WY	40-year Period
US Foggiest Place (West Coast)	2552 Hrs /Yr (Average)	Cape Disappointment, WA	10-Year Period or More
US Foggiest Place (East Coast)	1580 Hrs /Yr (Average)	Moose Peak Lighthouse, Mistake Island, ME	10-Year Period or More
Canada – Highest Number of Thunderstorm Days Per Year	242	Kampala, Uganda	10-year Period
Highest Number of Thunderstorm Days Per Year	322	Bogor, Indonesia	1916 to 1920
Average Afternoon Dewpoint in June	29.9°C (84°F)	Assab, Ethiopia	Unavailable
Highest Absolute Humidity Observation	35°C (95°F) Dew Point	Dhahran, Saudi Arabia	8 July 2003

MIL-STD-810H
PART THREE ANNEX B**PART THREE ANNEX B - Terminology****1. TERMS.** (AR 70-38)

The following terms apply to this Part.

1.1 Climatic design types.

Four climatic design types are differentiated based on worldwide temperature extremes. They are:

- a. Hot climatic design type.
- b. Basic climatic design type.
- c. Cold climatic design type.
- d. Severe cold climatic design type.

Areas of the world where these types apply are shown in Figure 1. The climatic values included in the design types represent the extreme conditions that items of materiel are likely to encounter in the field, with allowance for some risk (see Annex C, paragraph 1.2).

1.2 Daily weather cycles.

Each of the climatic design types is characterized by one or more daily weather cycles, that show the interactions and daily patterns of temperature, humidity, and solar radiation (where applicable).

- a. Four cycles represent the basic design type.
 - (1) One for the hottest days, and one for the coldest days likely to be found in the basic design areas.
 - (2) Two cycles represent areas where high humidity is a major problem. Materiel that can operate satisfactorily under all four of these daily weather cycles should be capable of satisfactory performance throughout the areas of the basic design type.
- b. The hot climatic design type is characterized by two daily weather cycles, one representing the highest temperatures likely to be found anywhere in the world, and the other representing extremely high dewpoints.
- c. The cold climatic design type and the severe cold climatic design type are each represented by one daily weather cycle, the latter representing the lowest temperatures in which materiel operation is required.

Details of the daily weather cycles that make up the climatic design types are given in paragraph 4 in the front portion of this Part.

1.3 Operational, and storage and transit conditions.

In each of the seven daily weather cycles, a distinction is made between operational temperature and humidity conditions, and storage and transit temperature and humidity conditions.

- a. Operational conditions. These are climatic conditions in the open to which materiel might be subjected during operations or standby for operations. Ambient temperature and humidity conditions are those measured under standard conditions of ventilation and radiation shielding in a meteorological shelter at a height of 1.2 to 1.8 meters (4 to 6 feet) above the ground and determined according to the risk policy in paragraph 6.2. Solar radiation that might be experienced concurrently with the temperature and humidity, is also stated for many of the climatic conditions. Although the standard conditions measured in meteorological shelters are usually not exactly the same as the operational environment for materiel, it is necessary to state operational conditions in standard terms so:
 - (1) Measurements have the same meaning in all parts of the world.
 - (2) The great range of variations in response of different materiel to a given climatic condition is not a complicating factor in setting design criteria.

For example, the temperature of the materiel itself may vary considerably from the operational air temperature because of the effects of incoming solar radiation, internal sources of heat, the thermal mass, and the heat transfer characteristics of the materials. Most items exposed to the sun will attain higher temperatures than the air temperature. The exact temperature can be obtained through actual or simulated exposure to the appropriate daily cycle, or through the development and use of suitable mathematical models.

MIL-STD-810H
PART THREE ANNEX B

b. Storage and transit conditions. These are temperature and humidity conditions to which materiel might be subjected in storage and transit situations. Examples of these situations are:

- (1) Inside an unventilated field storage shelter.
- (2) In a railway boxcar.
- (3) Dump stored in the open.

Because of great differences in temperature and humidity in varying storage modes, the severity of the exposure depends upon the choice of storage mode as much as the storage location. This is very important in areas of extreme solar radiation and high humidity. Storage and transit air temperature and humidity may differ from operational temperature and humidity because of the induced effects of heat gains or losses of air in confined spaces. Where a large thermal mass is involved (e.g., in food storage), the temperature of the stores may be much lower than the storage air temperature stated, and may have little daily variation. Temperature for such a thermal mass is derived by using data from previous studies of similar storage conditions, or is determined by actual measurement under current conditions. Life Cycle Environmental Profiles (LCEPs) and requirements documents must be derived for specific systems to generate sets of design and test criteria. Procedures for preparing LCEPs are found in Part One of this document, along with guidance on other environmental engineering tasks.

MIL-STD-810H
PART THREE ANNEX C**PART THREE ANNEX C - Comparison of AR 70-38 with MIL-HDBK-310****1. RELATIONSHIP BETWEEN AR 70-38¹ AND MIL-HDBK-310*****1.1 Background.**

AR 70-38 and MIL-HDBK-310 are the Army and DoD documents, respectively, that provide environmental information and data for the derivation of design criteria through the tailoring process. The two documents are similar in many respects. Both publications reflect a philosophy that accepts a small risk of failure during periods of extreme weather. They also require a complete return to operation after exposure to extreme conditions has ended. MIL-HDBK-310, however, considers only the likelihood of natural extremes occurring, whereas AR 70-38 considers the induced conditions many items are exposed to during transit and storage. This difference means that Army materiel must be able to withstand much higher air temperatures than those in MIL-HDBK-310, although the high temperatures for operation are the same. The principal differences between the AR and the MIL-HDBK are:

- a. The MIL-HDBK is limited to climatic information only (with the exception of blowing sand and dust that is a combination of soil and climatic conditions), whereas the AR provides additional guidance for terrain factors and weather related atmospheric obscurants.
- b. The MIL-HDBK provides data and guidance for both worldwide and regional applications, whereas the AR divides the land areas of the world into design types, some of which are subdivided into multiple daily weather cycles. Prior to the 1987 edition, there were no regional types given in MIL-STD-210. The regional types of the "C" version were derived from the 1979 edition of AR 70-38. Although the AR does not specifically state worldwide values, they can be derived by using the most extreme values from the most extreme daily weather cycles (hot and severe cold) for each climatic element.
- c. The MIL-HDBK provides guidance and data for coastal/oceanic conditions and upper air conditions, neither of which is covered by the AR. The oceans and upper air are, by tradition, primarily areas of concern for the Navy, Air Force, and Army users who have need for such information should consult MIL-HDBK-310. (Its predecessor, MIL-STD-210, was prepared by the Geophysics Laboratory of the United States Air Force Systems Command).
- d. The MIL-HDBK is tailored in a somewhat different manner than the AR. The former does not provide values for storage/transit conditions, whereas the Army approach is that some guidance in this area is needed. The AR provides one level of risk for operational conditions and a second level for storage/transit conditions. The MIL-STD provides several levels for operational conditions and another level for what is referred to as withstanding conditions. These different risk levels in the MIL-STD are described as follows:
 - (1) Frequency-of-occurrence values. These are for use in most operational circumstances, and are presented as 1.0, 5.0, 10.0, and 20.0 percent (or other, if appropriate) risk levels for the worst month in the most severe area of occurrence.
 - (2) Long-term climatic extremes. For most climatic elements, values are given that are expected to occur at least once, for a short duration (less than 3 hours) during approximately 10, 30, or 60 years of materiel exposure. These are much rarer events than those cited for the frequency-of-occurrence values above. Their use should be limited to specifying conditions that materiel must be able to withstand, but not for which it is expected to be operational. These are generally derived by extreme-value statistical analysis.
 - (3) Absolute extremes. The most extreme value ever recorded (not necessarily the most extreme that has ever occurred) is also provided for each element. These are for use when it is determined that materiel should be designed to operate in the most severe conditions it is ever likely to encounter (assuming this is within technical capabilities). Generally, this would be the case only when disastrous consequences would result from failure to operate.

When greater detail is required for the tailoring process, suggest users of AR 70-38 look for corresponding climatic

¹ While AR 70-38 is an Army Regulation, its basic content includes the presentation of world-wide climatic conditions that is comparable to that included in MIL-HDBK-310, and NATO STANAG 4370, AECTP 200, Category 230, Section 2311.

* Available from the Defense Logistics Agency Document Services, <http://quicksearch.dla.mil>.

MIL-STD-810H
PART THREE ANNEX C

elements in MIL-HDBK-310 that will provide a wider range of values at different risk levels for design application.

1.2 Risk policy.

In the Ground Environment section, MIL-HDBK-310 contains single worldwide values for each climatic element to be considered in the design of materiel for operations. For most climatic elements, the design value selected was the value exceeded not more than one percent of the hours in the most extreme month in an average year at the most severe location for that element. (For low temperature, the level selected was 20 percent of the hours and, for rainfall, the level selected was 0.5 percent of the hours.) These values have become known as one percent design values. When they are applied collectively, they are often referred to as a one percent risk policy. Although this is a convenient short designation, it can be misleading to those who are not aware of this specific definition of a one percent risk policy. In fact, there is no way to quantify, with any degree of accuracy, the probability that materiel will ever encounter a given extreme of an environmental element. It can be stated with assurance that the designated one percent risk levels as used in MIL-HDBK-310 are very conservative. For example, on a year-round basis, the risk of encountering the design level of a selected element approaches 1/12 of one percent (there is some likelihood of occurrence in other than the most extreme month). Also, for many of the climatic elements, the design value applies only to the most severe location in the world. Therefore, the risk of materiel encountering this extreme may be very small, particularly if the value at the most severe location is representative of only a small area or the location is in a remote part of the world.

The above considerations led to the adoption of the system now used in AR 70-38. It provides alternate design values for items not intended for worldwide use. Consequently, the world was divided, on the basis of temperature, into four types. The design temperatures in this four-type division are somewhat arbitrary. However, the geographic areas encompassed by the basic design type contain most of the world's population and landmass. In general, the lines delimiting the areas included in a design type are drawn on the basis of having one percent of the hours in the most severe month on average exceeding the design temperature. Note, it is only along the demarcation line that this criterion applies exactly. For example, if more than one percent of the hours in the coldest month at a given location are below -46°C (-50°F), the area represented by that location is considered part of the severe cold climatic design type. Yet, at that location, there may be almost no chance of occurrence of -51°C (-60°F), that is the lower design value for that type. On the other hand, there are stations in the areas included in the severe cold design type that have temperatures below -51°C (-60°F) for as much as 20 percent of the hours in the coldest month. This kind of variation within the regions could be eliminated only by creating a large number of small regions, a procedure that would make this delineation unduly complex.

1.3. Additional guidance.

A general discussion such as this one cannot possibly address in detail the environmental considerations for all materiel. Thus, users are encouraged to seek additional or more specific guidance from the proponent agency.

MIL-STD-810H
PART THREE ANNEX C

Custodians:

Army – TE
Navy – AS
Air Force – 11

Preparing activity:

Army - TE
(Project ENVR-2018-004)

Review activities:

Army – AI, AR, AT, AV, CE, CR, EA, GL, MI, MT, SM
Navy – CH, EC, MC, OS, SH, YD
Air Force – 19, 85

NOTE: The activities listed above were interested in this document as of the date of this document. Since organizations and responsibilities can change, you should verify the currency of the information above using the ASSIST Online database at <https://assist.dla.mil/>.

The Preparing Activity responsibility for MIL-STD-810 transferred from Air Force Code 11 to Army Code TE on 14 November 2008.